

Nikon

DIGITAL CAMERA

Z fc

Reference Guide

- Read this document thoroughly before using the camera.
- To ensure proper use of the camera, be sure to read “For your safety” (page 28).
- After reading this document, keep it readily accessible for future reference.

When your first photo can't wait

Getting ready

1 Insert the battery and memory card (☐75).

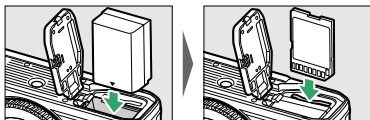

For information on charging the battery, see “Charging the battery” (☐74).

2 Attach a lens (☐78).

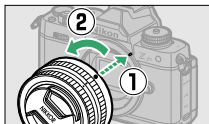

- Align the white dot on the lens with the white dot on the camera body (①) and rotate the lens in the direction shown (②).
- A strap can be attached to the camera. For more information, see “Attaching the strap” (☐73).

3 Turn the camera on and then choose a language and set the clock (☐81).

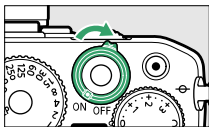

Z fc Model Name: N2016

■ Take (☞85) and view (☞96) pictures

- 1 Rotate the mode selector to AUTO (☞8).

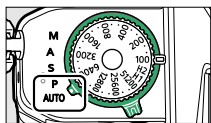

- 2 To focus, press the shutter-release button halfway (i.e, lightly press the shutter-release button, stopping when it is pressed halfway).

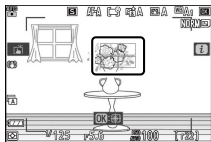

- 3 Without lifting your finger from the shutter-release button, press the button the rest of the way down to take the picture.



- 4 View the picture.

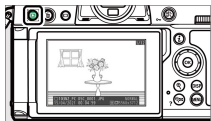

Package contents

Be sure all items listed here were included with your camera.

Camera



BF-N1 body cap



DK-32 rubber eyecup (comes attached to camera, □564)



- Memory cards are sold separately.
- Purchasers of the lens kit option should confirm that the package also includes a lens.

The Nikon download center

Visit the Nikon download center to download firmware updates, NX Studio and other Nikon software, and documentation for Nikon products including cameras, NIKKOR lenses, and flash units.

<https://downloadcenter.nikonimglib.com/>

EN-EL25 rechargeable Li-ion battery

MH-32 battery charger (plug adapter supplied in countries or regions where required; shape depends on country of sale)

AN-DC23 strap (□73)



Warranty

User's Manual

About this document

■ Symbols

This document employs the following symbols and conventions. Use them to help locate the information you need.

	This icon marks notes, information that should be read before using this product.
	This icon marks tips, additional information you may find helpful when using this product.
	This icon marks references to other sections in this document.

■ Conventions

- This camera uses SD, SDHC, and SDXC memory cards, referred to throughout this document as “memory cards”. SD, SDHC, and SDXC may also on occasion be referred to as “SD memory cards”.
- Throughout this document, battery chargers are referred to as “battery chargers” or “chargers”.
- Throughout this document, the display in camera monitor and viewfinder during shooting is referred to as the “shooting display”; in most cases, the illustrations show the monitor.
- Throughout this document, smartphones and tablets are referred to as “smart devices”.
- Throughout this document, the term “default settings” is used to refer to the settings in effect at shipment. The explanations in this document assume that default settings are used.





⚠ For your safety

“For your safety” contains important safety instructions. Be sure to read them before using the camera. For more information, see “For your safety” (□□28).

Table of contents

When your first photo can't wait	2
Package contents	4
About this document	5
Menu list	22
For your safety	28
Notices	33

Getting to know the camera **36**

Parts of the camera	36
Camera body	36
Control panel	40
The monitor and viewfinder	41
Camera controls	44
Viewfinder	44
The  (monitor mode) button	45
The mode selector	47
The shutter-speed dial	47
The command dials	48
The ISO sensitivity dial	49
The exposure compensation dial	50
Monitor	50
Touch controls	54
The DISP button	61
The  and  (?) buttons	63
The  () button	63
The MENU button	64
The <i>i</i> button (the <i>i</i> menu)	68
The Fn button	71

First steps **73**

Attaching the strap	73
---------------------------	----

Charging the battery	74
Inserting the battery and a memory card	75
Battery level	76
Number of exposures remaining	77
Attaching a lens	78
Detaching lenses	79
Opening the monitor	80
Turning on the camera	81

Basic photography and playback **85**

Taking photographs (AUTO auto)	85
Recording videos (AUTO auto)	90
Taking photos in video mode	92
Viewing photos	96
Viewing videos	96
Deleting unwanted pictures	98

Basic settings **100**

Focus	100
Focus mode	100
AF-area mode	102
The touch shutter	110
Manual focus	112
White balance	116
Adjusting white balance	116
Silent photography	121
Rating pictures	123
Protecting pictures from deletion	125

Shooting controls **127**

The mode selector	127
Using the mode selector	127
P (programmed auto)	128
S (shutter-priority auto)	128

A (aperture-priority auto)	130
M (manual)	131
The ISO sensitivity dial	137
Adjusting ISO sensitivity	137
The exposure compensation dial	139
Adjusting exposure compensation	139
The ^{AE-L} / _{AF-L} (○) button	142
Exposure lock	142
Focus lock	142
Locking focus and exposure	142

The *i* menu 145

The <i>i</i> menu	145
Still images	147
Set Picture Control	147
White balance	153
Image quality	160
Image size	161
Flash mode	162
Metering	162
Wi-Fi connection	164
Active D-Lighting	164
Release mode	166
Vibration reduction	171
AF-area mode	172
Focus mode	173
Videos	174
Set Picture Control	175
White balance	175
Frame size and rate/Video quality	175
Microphone sensitivity	178
Wind noise reduction	179
Metering	180



Wi-Fi connection	180
Active D-Lighting	181
Electronic VR	181
Vibration reduction	182
AF-area mode	182
Focus mode	182

Playback **183**

Viewing pictures	183
Full-frame playback	183
Thumbnail playback	184
Calendar playback	184
Photo information	186
File information	187
Exposure data	188
Highlight display	188
RGB histogram	189
Shooting data	192
Location data	196
Overview	197
The i button (playback mode)	199
Photos	199
Videos	201
Videos (playback paused)	202
Playback zoom	209
Using playback zoom	209
Deleting pictures	211
Using the delete button	211
Deleting multiple pictures	212

Menu guide **215**





Defaults	215
Playback menu defaults	215

Photo shooting menu defaults	216
Video recording menu defaults	220
Custom Settings menu defaults	222
Setup menu defaults	227
 The playback menu: Managing images	232
Delete	232
Playback folder	233
Playback display options	233
Picture review	234
Rotate tall	234
Slide show	234
Viewing slide shows	235
Rating	236
 The photo shooting menu: Shooting options	237
Reset photo shooting menu	238
Storage folder	238
Renaming folders	239
Select folder by number	239
Select folder from list	241
File naming	242
Choose image area	243
Image quality	244
Image size	244
RAW recording	245
ISO sensitivity settings	245
White balance	248
The white balance menu: Fine-tuning	249
The white balance menu: Choosing a color temperature	251
Preset manual: Copying white balance from a photograph	252
Set Picture Control	255
Modifying Picture Controls from the menus	255

Manage Picture Control	257
Creating custom Picture Controls	258
Color space	262
Active D-Lighting	262
Long exposure NR	262
High ISO NR	263
Vignette control	264
Diffraction compensation	264
Auto distortion control	265
Flicker reduction shooting	265
Metering	266
Flash control	267
Flash control mode	267
Wireless flash options	268
Group flash options	268
Flash mode	269
Flash compensation	269
Release mode	269
Focus mode	269
AF-area mode	270
Vibration reduction	270
Auto bracketing	270
Exposure and flash bracketing	271
White balance bracketing	276
ADL bracketing	279
Multiple exposure	281
Creating a multiple exposure	283
HDR (high dynamic range)	289
Taking HDR photographs	290
Interval timer shooting	296
Interval-timer photography	300
Time-lapse video	310
Recording time-lapse videos	311

Focus shift shooting	319
Focus shift photography	321
Silent photography	327
▶ The video recording menu: Video recording options	329
Reset video recording menu	330
File naming	330
Frame size/frame rate	330
Video quality	330
Video file type	331
ISO sensitivity settings	331
White balance	332
Set Picture Control	333
Manage Picture Control	333
Active D-Lighting	333
High ISO NR	334
Vignette control	334
Diffraction compensation	334
Auto distortion control	334
Flicker reduction	334
Metering	335
Release mode (save frame)	335
Focus mode	336
AF-area mode	336
Vibration reduction	336
Electronic VR	337
Microphone sensitivity	337
Attenuator	338
Frequency response	338
Wind noise reduction	339
Timecode	339
▶ Custom Settings: Fine-tuning camera settings	341
Reset custom settings	343
a: Autofocus	344

a1: AF-C priority selection	344
a2: AF-S priority selection	344
a3: Focus tracking with lock-on	345
a4: Focus points used	345
a5: Store points by orientation	346
a6: AF activation	348
Out-of-focus release	348
a7: Limit AF-area mode selection	349
a8: Focus point wrap-around	349
a9: Focus point options	350
Manual focus mode	350
Dynamic-area AF assist	350
a10: Low-light AF	350
a11: Built-in AF-assist illuminator	351
a12: Manual focus ring in AF mode	352
b: Metering/exposure	352
b1: Easy exposure compensation	352
b2: Center-weighted area	353
b3: Fine-tune optimal exposure	353
b4:  mode exposure comp.	354
c: Timers/AE lock	354
c1: Shutter-release button AE-L	354
c2: Self-timer	355
c3: Power off delay	355
d: Shooting/display	356
d1: CL mode shooting speed	356
d2: Maximum shots per burst	356
d3: Exposure delay mode	356
d4: Shutter type	357
d5: Extended shutter speeds (M)	357
d6: File number sequence	358
d7: Apply settings to live view	359
d8: Framing grid display	360

d9: Focus peaking	360
Peaking level	360
Peaking highlight color	360
d10: View all in continuous mode	361
e: Bracketing/flash	361
e1: Flash sync speed	361
e2: Flash shutter speed	362
e3: Exposure comp. for flash	363
e4: Auto  ISO sensitivity control	363
e5: Auto bracketing (mode M)	364
e6: Bracketing order	365
f: Controls	365
f1: Customize  menu	365
Bluetooth connection	366
f2: Custom controls (shooting)	367
f3: Custom controls (playback)	375
f4: Customize command dials	377
Reverse rotation	377
Change main/sub	378
Menus and playback	378
Sub-dial frame advance	379
f5: Release button to use dial	380
f6: Reverse indicators	381
g: Video	381
g1: Customize  menu	381
Bluetooth connection	382
g2: Custom controls	382
g3: AF speed	388
g4: AF tracking sensitivity	389
g5: Highlight display	389
Display pattern	389
Highlight display threshold	390
 The setup menu: Camera setup	391

Format memory card	392
Language	393
Time zone and date	393
Monitor brightness	394
Monitor color balance	394
Viewfinder brightness	396
Viewfinder color balance	396
Limit monitor mode selection	397
Information display	397
AF fine-tuning options	397
Creating and saving fine-tuning values	399
Choosing a default fine-tuning value	400
Non-CPU lens data	400
Save focus position	401
Image Dust Off ref photo	401
Acquiring Image Dust Off reference data	402
Pixel mapping	403
Image comment	404
Input comment	404
Attach comment	404
Copyright information	405
Artist/Copyright	405
Attach copyright information	405
Beep options	406
Beep on/off	406
Volume	407
Pitch	407
Touch controls	407
Enable/disable touch controls	407
Full-frame playback flicks	407
Self-portrait mode	408
HDMI	408
Airplane mode	408

Connect to smart device	408
Pairing (Bluetooth)	408
Select for upload (Bluetooth)	409
Wi-Fi connection	409
Upload while off	410
Location data (smart device)	410
Connect to computer	411
Wi-Fi connection	411
Network settings	411
Options	412
MAC address	413
Wireless remote (ML-L7) options	413
Wireless remote connection	414
Save wireless remote controller	414
Delete wireless remote controller	414
Assign Fn1 button/Assign Fn2 button	414
Conformity marking	415
USB power delivery	415
Energy saving (photo mode)	417
Slot empty release lock	418
Save/load menu settings	419
Save menu settings	422
Load menu settings	422
Reset all settings	423
Firmware version	423
<input checked="" type="checkbox"/> The retouch menu: Creating retouched copies	424
Creating retouched copies	425
RAW processing: Converting RAW to JPEG	428
Trim	431
Resize	432
Resizing multiple images	432
D-Lighting	436
Red-eye correction	437

Straighten	438
Distortion control	438
Perspective control	439
Monochrome	440
Overlay pictures	441
Add	441
Lighten and darken	445
Trim video	448
☰ My Menu/☰ Recent settings	449
☰ My Menu: Creating a custom menu	449
☰ Recent settings: Accessing recently-used settings	455

Establishing wireless connections to computers or smart devices 456

Network options	456
Connecting to computers via Wi-Fi	457
What Wi-Fi can do for you	457
The Wireless Transmitter Utility	457
Infrastructure and access-point modes	457
Connecting in access-point mode	459
Connecting in infrastructure mode	465
Uploading pictures	473
Disconnecting and reconnecting	477
Connecting to smart devices	479
The SnapBridge app	479
What SnapBridge can do for you	479
Wireless connections	480
Connecting via Bluetooth (pairing)	480
Connecting via Wi-Fi (Wi-Fi mode)	483
Troubleshooting	488

Cabled connections to computers and HDMI devices	489
Connecting to computers via USB	489
Installing NX Studio	489
Copying pictures to a computer using NX Studio	490
Connecting to HDMI devices	494
TVs	494
Recorders	494
On-Camera flash photography	497
“On-camera” versus “remote”	497
Camera-mounted flash units	497
Remote flash photography	497
Using an on-camera flash	498
Flash control mode	501
Flash modes	502
Flash compensation	504
FV lock	505
Remote flash photography	508
What is remote flash photography?	508
Controlling remote flash units	509
Using optical AWL with the SB-500	509
Troubleshooting	513
Before contacting customer support	513
Problems and solutions	515
Battery/display	515
Shooting	516
Playback	520
Bluetooth and Wi-Fi (wireless networks)	522
Miscellaneous	523
Alerts and error messages	524

Alerts	524
Error messages	526

Technical notes **529**

Compatible lenses and accessories	529
Camera displays	530
Monitor	530
Viewfinder	538
Compatible flash units	543
The Nikon Creative Lighting System (CLS)	543
Features available with CLS-compatible flash units ..	543
Notes and tips for optional flash units	559
Other compatible accessories	563
Charging the camera with the charging AC adapter.....	
.....	565
ML-L7 Remote Control	567
Software	573
Caring for the camera	574
Storage	574
Cleaning	574
Manual cleaning	575
Caring for the camera and battery: Cautions	578
Camera care	578
Battery care	581
Using the charger	583
Using the charging AC adapter	584
Specifications	585
Nikon Z fc digital camera	585
Approved memory cards	598
Portable chargers (power banks)	599
Memory card capacity	600
Battery endurance	602
AF-assist illumination	604

Trademarks and licenses	605
Notices	608
Bluetooth and Wi-Fi (wireless LAN)	611

Index **617**

Menu list

The camera offers the following menus. For a more complete description of individual menu items, refer to the “Menu guide” chapter.

PLAYBACK MENU	PHOTO SHOOTING MENU
Delete	Reset photo shooting menu
Playback folder	Storage folder
Playback display options	File naming
Picture review	Choose image area
Rotate tall	Image quality
Slide show	Image size
Rating	RAW recording
	ISO sensitivity settings
	White balance
	Set Picture Control
	Manage Picture Control
	Color space
	Active D-Lighting
	Long exposure NR
	High ISO NR
	Vignette control
	Diffraction compensation
	Auto distortion control
	Flicker reduction shooting
	Metering
	Flash control
	Flash mode
	Flash compensation

PHOTO SHOOTING MENU

Release mode

Focus mode

AF-area mode

Vibration reduction

Auto bracketing

Multiple exposure

HDR (high dynamic range)

Interval timer shooting

Time-lapse video

Focus shift shooting

Silent photography

VIDEO RECORDING MENU

Reset video recording menu

File naming

Frame size/frame rate

Video quality

Video file type

ISO sensitivity settings

White balance

Set Picture Control

Manage Picture Control

Active D-Lighting

High ISO NR

Vignette control

Diffraction compensation

Auto distortion control

Flicker reduction

Metering

Release mode (save frame)

Focus mode

AF-area mode

Vibration reduction

Electronic VR

Microphone sensitivity



Attenuator

Frequency response

Wind noise reduction

Timecode

CUSTOM SETTINGS MENU	
Reset custom settings	
a Autofocus	
a1	AF-C priority selection
a2	AF-S priority selection
a3	Focus tracking with lock-on
a4	Focus points used
a5	Store points by orientation
a6	AF activation
a7	Limit AF-area mode selection
a8	Focus point wrap-around
a9	Focus point options
a10	Low-light AF
a11	Built-in AF-assist illuminator
a12	Manual focus ring in AF mode
b Metering/exposure	
b1	Easy exposure compensation
b2	Center-weighted area
b3	Fine-tune optimal exposure
b4	 mode exposure comp.
c Timers/AE lock	
c1	Shutter-release button AE-L
c2	Self-timer
c3	Power off delay
d Shooting/display	
d1	CL mode shooting speed
d2	Maximum shots per burst

CUSTOM SETTINGS MENU	
d3	Exposure delay mode
d4	Shutter type
d5	Extended shutter speeds (M)
d6	File number sequence
d7	Apply settings to live view
d8	Framing grid display
d9	Focus peaking
d10	View all in continuous mode
e Bracketing/flash	
e1	Flash sync speed
e2	Flash shutter speed
e3	Exposure comp. for flash
e4	Auto  ISO sensitivity control
e5	Auto bracketing (mode M)
e6	Bracketing order
f Controls	
f1	Customize  menu
f2	Custom controls (shooting)
f3	Custom controls (playback)
f4	Customize command dials
f5	Release button to use dial
f6	Reverse indicators
g Video	
g1	Customize  menu
g2	Custom controls
g3	AF speed

CUSTOM SETTINGS MENU	
g4	AF tracking sensitivity
g5	Highlight display

SETUP MENU
Format memory card
Language
Time zone and date
Monitor brightness
Monitor color balance
Viewfinder brightness
Viewfinder color balance
Limit monitor mode selection
Information display
AF fine-tuning options
Non-CPU lens data
Save focus position
Image Dust Off ref photo
Pixel mapping
Image comment
Copyright information
Beep options
Touch controls
Self-portrait mode
HDMI
Airplane mode
Connect to smart device
Connect to computer
Wireless remote (ML-L7) options
Conformity marking
USB power delivery

SETUP MENU

Energy saving (photo mode)

Slot empty release lock

Save/load menu settings

Reset all settings

Firmware version

RETOUCH MENU

RAW processing

Trim

Resize

D-Lighting

Red-eye correction

Straighten

Distortion control

Perspective control

Monochrome

Overlay pictures

Trim video

MY MENU

Add items

Remove items

Rank items

Choose tab

For your safety

To prevent damage to property or injury to yourself or to others, read “For your safety” in its entirety before using this product.

After reading these safety instructions, keep them readily accessible for future reference.

▲ **DANGER:** Failure to observe the precautions marked with this icon carries a high risk of death or severe injury.

▲ **WARNING:** Failure to observe the precautions marked with this icon could result in death or severe injury.

▲ **CAUTION:** Failure to observe the precautions marked with this icon could result in injury or property damage.



WARNING

Do not use while walking or operating a vehicle.

Failure to observe this precaution could result in accidents or other injury.

Do not disassemble or modify this product. Do not touch internal parts that become exposed as the result of a fall or other accident.

Failure to observe these precautions could result in electric shock or other injury.

Should you notice any abnormalities such as the product producing smoke, heat, or unusual odors, immediately disconnect the battery or power source.

Continued operation could result in fire, burns or other injury.

Keep dry. Do not handle with wet hands. Do not handle the plug with wet hands.

Failure to observe these precautions could result in fire or electric shock.

Do not let your skin remain in prolonged contact with this product while it is on or plugged in.

Failure to observe this precaution could result in low-temperature burns.

Do not use this product in the presence of flammable dust or gas such as propane, gasoline or aerosols.

Failure to observe this precaution could result in explosion or fire.

Do not directly view the sun or other bright light source through the lens.

Failure to observe this precaution could result in visual impairment.

Do not aim the flash or AF-assist illuminator at the operator of a motor vehicle.

Failure to observe this precaution could result in accidents.

Keep this product out of reach of children.

Failure to observe this precaution could result in injury or product malfunction. In addition, note that small parts constitute a choking hazard. Should a child swallow any part of this product, seek immediate medical attention.

Do not entangle, wrap or twist the straps around your neck.

Failure to observe this precaution could result in accidents.

Do not use batteries, chargers, AC adapters, or USB cables not specifically designated for use with this product. When using batteries, chargers, AC adapters, and USB cables designated for use with this product, do not:

- **Damage, modify, forcibly tug or bend the cords or cables, place them under heavy objects, or expose them to heat or flame.**
- **Use travel converters or adapters designed to convert from one voltage to another or with DC-to-AC inverters.**

Failure to observe these precautions could result in fire or electric shock.

Do not handle the plug when charging the product or using the AC adapter during thunderstorms.

Failure to observe this precaution could result in electric shock.

Do not handle with bare hands in locations exposed to extremely high or low temperatures.

Failure to observe this precaution could result in burns, or frostbite.

 **CAUTION**

Do not leave the lens pointed at the sun or other strong light sources.

Light focused by the lens could cause fire or damage to product's internal parts. When shooting backlit subjects, keep the sun well out of the frame. Sunlight focused into the camera when the sun is close to the frame could cause fire.

Turn this product off when its use is prohibited. Disable wireless features when the use of wireless equipment is prohibited.

The radio-frequency emissions produced by this product could interfere with equipment onboard aircraft or in hospitals or other medical facilities.

Remove the battery and disconnect the AC adapter if this product will not be used for an extended period.

Failure to observe this precaution could result in fire or product malfunction.

Do not fire the flash in contact with or in close proximity to the skin or objects.

Failure to observe this precaution could result in burns or fire.

Do not leave the product where it will be exposed to extremely high temperatures, for an extended period such as in an enclosed automobile or in direct sunlight.

Failure to observe this precaution could result in fire or product malfunction.

Do not look directly at the AF-assist illuminator.

Failure to observe this precaution could have adverse effects on vision.

Do not transport cameras or lenses with tripods or similar accessories attached.

Failure to observe this precaution could result in injury or product malfunction.



DANGER (Batteries)

Do not mishandle batteries.

Failure to observe the following precautions could result in the batteries leaking, overheating, rupturing, or catching fire:

- Use only rechargeable batteries approved for use in this product.
 - Do not expose batteries to flame or excessive heat.
 - Do not disassemble.
 - Do not short-circuit the terminals by touching them to necklaces, hairpins, or other metal objects.
 - Do not expose batteries or the products in which they are inserted to powerful physical shocks.
 - Do not step on batteries, pierce them with nails, or strike them with hammers.
-

Charge only as indicated.

Failure to observe this precaution could result in the batteries leaking, overheating, rupturing, or catching fire.

If battery liquid comes into contact with the eyes, rinse with plenty of clean water and seek immediate medical attention.

Delaying action could result in eye injuries.

Follow the instructions of airline personnel.

Batteries left unattended at high altitudes in an unpressurized environment may leak, overheat, rupture, or catch fire.



WARNING (Batteries)

Keep batteries out of reach of children.

Should a child swallow a battery, seek immediate medical attention.

Keep batteries out of reach of household pets and other animals.

The batteries could leak, overheat, rupture, or catch fire if bitten, chewed, or otherwise damaged by animals.

Do not immerse batteries in water or expose to rain.

Failure to observe this precaution could result in fire or product malfunction. Immediately dry the product with a towel or similar object should it become wet.

Discontinue use immediately should you notice any changes in the batteries, such as discoloration or deformation. Cease charging EN-EL25 rechargeable batteries if they do not charge in the specified period of time.

Failure to observe these precautions could result in the batteries leaking, overheating, rupturing, or catching fire.

When batteries are no longer needed, insulate the terminals with tape.

Overheating, rupture, or fire may result should metal objects come into contact with the terminals.

If battery liquid comes into contact with a person's skin or clothing, immediately rinse the affected area with plenty of clean water.

Failure to observe this precaution could result in skin irritation.

Notices

- No part of the documentation included with this product may be reproduced, transmitted, transcribed, stored in a retrieval system, or translated into any language in any form, by any means, without Nikon's prior written permission.
- Nikon reserves the right to change the appearance and specifications of the hardware and software described in this documentation at any time and without prior notice.
- Nikon will not be held liable for any damages resulting from the use of this product.
- While every effort has been made to ensure that the information in this documentation is accurate and complete, we would appreciate it were you to bring any errors or omissions to the attention of the Nikon representative in your area (address provided separately).

● **Notice concerning prohibition of copying or reproduction**

Note that simply being in possession of material that has been digitally copied or reproduced by means of a scanner, digital camera, or other device may be punishable by law.

• **Items prohibited by law from being copied or reproduced**

Do not copy or reproduce paper money, coins, securities, government bonds, or local government bonds, even if such copies or reproductions are stamped "Sample".

The copying or reproduction of paper money, coins, or securities which are circulated in a foreign country is prohibited.

Unless the prior permission of the government has been obtained, the copying or reproduction of unused postage stamps or post cards issued by the government is prohibited.

The copying or reproduction of stamps issued by the government and of certified documents stipulated by law is prohibited.

• **Cautions on certain copies and reproductions**

The government has issued cautions on copies or reproductions of securities issued by private companies (shares, bills, checks, gift certificates,

etc.), commuter passes, or coupon tickets, except when a minimum of necessary copies are to be provided for business use by a company. Also, do not copy or reproduce passports issued by the government, licenses issued by public agencies and private groups, ID cards, and tickets, such as passes and meal coupons.

- **Comply with copyright notices**

Under copyright law, photographs or recordings of copyrighted works made with the camera cannot be used without the permission of the copyright holder. Exceptions apply to personal use, but note that even personal use may be restricted in the case of photographs or recordings of exhibits or live performances.

- **Use only Nikon brand electronic accessories**

Nikon cameras are designed to the highest standards and include complex electronic circuitry. Only Nikon brand electronic accessories (including lenses, chargers, batteries, AC adapters, and flash accessories) certified by Nikon specifically for use with this Nikon digital camera are engineered and proven to operate within the operational and safety requirements of this electronic circuitry.

The use of non-Nikon electronic accessories could damage the camera and may void your Nikon warranty. The use of third-party rechargeable Li-ion batteries not bearing the Nikon holographic seal shown below could interfere with normal operation of the camera or result in the batteries overheating, igniting, rupturing, or leaking.



For more information about Nikon brand accessories, contact a local authorized Nikon dealer.

- **Memory cards**

- Memory cards may be hot after use. Observe due caution when removing memory cards from the camera.
- Do not perform the following operations during formatting or while data are being recorded, deleted, or copied to a computer or other

device. Failure to observe these precautions could result in loss of data or in damage to the camera or card.

- Do not remove or insert memory cards
- Do not turn the camera off
- Do not remove the battery
- Do not touch the card terminals with your fingers or metal objects.
- Do not use excessive force when handling memory cards. Failure to observe this precaution could damage the card.
- Do not bend or drop memory cards or subject them to strong physical shocks.
- Do not expose memory cards to water, heat, or direct sunlight.
- Do not format memory cards in a computer.

✔ Before taking important pictures

Before taking pictures on important occasions (such as at weddings or before taking the camera on a trip), take a test shot to ensure that the camera is functioning normally. Nikon will not be held liable for damages or lost profits that may result from product malfunction.

✔ Life-long learning

As part of Nikon's "Life-long learning" commitment to ongoing product support and education, continually-updated information is available on-line at the following sites:

- **For users in the U.S.A.:** <https://www.nikonusa.com/>
- **For users in Europe and Africa:** <https://www.europe-nikon.com/support/>
- **For users in Asia, Oceania, and the Middle East:** <https://www.nikon-asia.com/>

Visit these sites to keep up-to-date with the latest product information, tips, answers to frequently-asked questions (FAQs), and general advice on digital imaging and photography. Additional information may be available from the Nikon representative in your area. See the following URL for contact information: <https://imaging.nikon.com/>

Getting to know the camera

Parts of the camera

Camera body

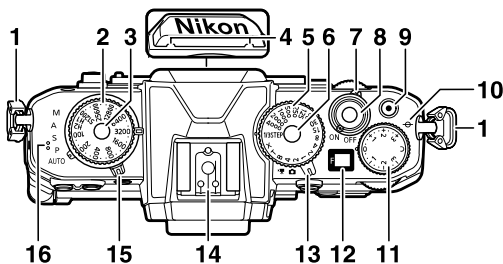

- | | | | |
|---|---|----|--|
| 1 | Eyelet for camera strap (☐73) | 9 | Video-record button (☐90) |
| 2 | ISO sensitivity dial (☐49, ☐137) | 10 | ∅ (focal plane mark; ☐114) |
| 3 | ISO sensitivity dial lock release (☐49, ☐137) | 11 | Exposure compensation dial (☐50, ☐139) |
| 4 | Stereo microphone (☐90) | 12 | Control panel (☐40) |
| 5 | Shutter-speed dial (☐47, ☐128) | 13 | Photo/video selector (☐85, ☐90) |
| 6 | Shutter-speed dial lock release (☐47, ☐128) | 14 | Accessory shoe (for optional flash unit; ☐498, ☐543) |
| 7 | Power switch (☐81) | 15 | Mode selector (☐47, ☐127) |
| 8 | Shutter-release button (☐85) | 16 | Speaker (☐97) |

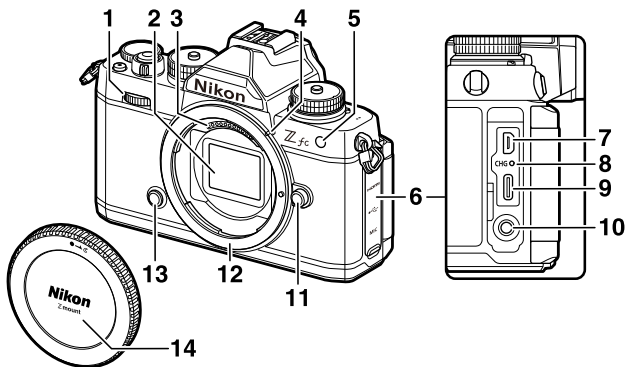

- 1 Sub-command dial (☐48)
- 2 Image sensor (☐575)
- 3 CPU contacts
- 4 Lens mounting mark (☐78)
- 5 AF-assist illuminator (☐88, ☐351)
Red-eye reduction lamp (☐162, ☐502)
Self-timer lamp (☐169)
- 6 Cover for HDMI, USB, and microphone connectors
- 7 HDMI connector (☐494)

- 8 Charge lamp (☐565)
- 9 USB connector (☐415, ☐489)
- 10 Connector for external microphone (☐565)
- 11 Lens release button (☐79)
- 12 Lens mount (☐78, ☐114)
- 13 Fn button (☐71, ☐116)
- 14 Body cap (☐78)

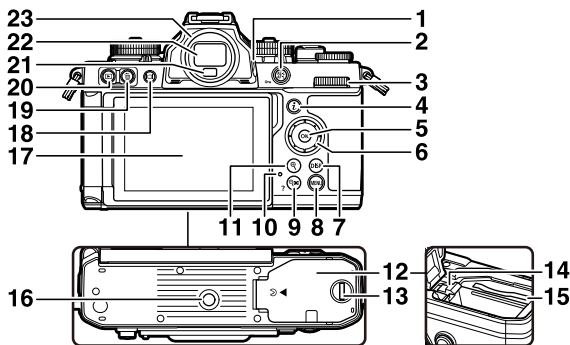

- | | |
|----|-------------------------------------|
| 1 | Diopter adjustment control (□44) |
| 2 | ☑ (☑) button (□63, □125, □142) |
| 3 | Main command dial (□48) |
| 4 | z button (□68, □145) |
| 5 | ⊗ button (□65) |
| 6 | Multi selector (□65, □106) |
| 7 | DISP button (□61) |
| 8 | MENU button (□64, □215) |
| 9 | ☑ (?) button (□63, □68, □183, □209) |
| 10 | Memory card access lamp (□88, □92) |
| 11 | ☑ button (□63, □112, □183, □209) |

- | | |
|----|--|
| 12 | Battery-chamber/memory card slot cover |
| 13 | Battery-chamber/memory card slot cover latch |
| 14 | Battery latch (□75) |
| 15 | Memory card slot (□75) |
| 16 | Tripod socket |
| 17 | Monitor (□50, □54, □110) |
| 18 | ☑ button (□45, □397) |
| 19 | ☑ button (□98, □211) |
| 20 | ☑ button (□96, □183) |
| 21 | Eye sensor (□44) |
| 22 | Viewfinder (□44) |
| 23 | Rubber eyecup (□564) |

✔ **Do not touch the image sensor**

Under no circumstances should you exert pressure on the image sensor, poke it with cleaning tools, or subject it to powerful air currents from a blower. These actions could scratch or otherwise damage the sensor. For information on cleaning the image sensor, see “Manual cleaning” (□575).

✔ **Product serial number**

The serial number for this product can be found by opening the monitor.

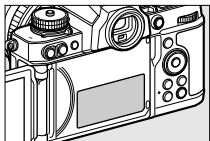

Control panel

When the camera is turned on, the control panel turns on.

The aperture (☐130, ☐131) is displayed in the control panel.



- If the aperture is set to F0.95, [**.95**] is displayed in the control panel.
- If [**Extended shutter speeds (M)**] is set to [**On**], the display switches to indicate that the shutter is open when shooting starts with the shutter speed set to 60 seconds or longer.
- Depending on how the lens is mounted, a warning [--] may be displayed (☐524).
- When connecting to a computer or smartphone, [**PC**] may be displayed to indicate that connection is in progress.

The monitor and viewfinder

Photo mode

At default settings, the following indicators appear in the monitor and viewfinder; for a full list of indicators, see “Camera displays” (□530) in “Technical notes”.

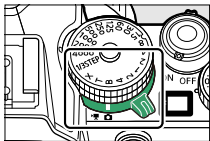

Monitor

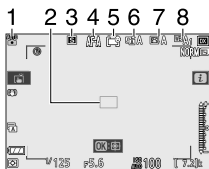

- 1 Shooting mode (□127)
- 2 Focus point (□102)
- 3 Release mode (□166)
- 4 Focus mode (□100)
- 5 AF-area mode (□102)

Viewfinder

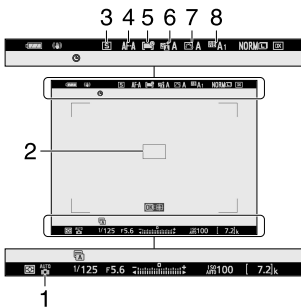

- 6 Active D-Lighting (□164)
- 7 Picture Control (□147, □255)
- 8 White balance (□116, □153, □248)

Monitor

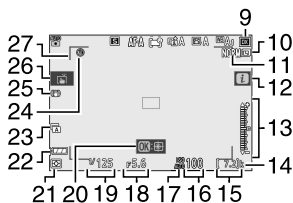

9	Image area (□243)
10	Image size (□161)
11	Image quality (□160)
12	z icon (□145)
13	Exposure indicator Exposure (□133) Exposure compensation (□139)
14	“k” (appears when memory remains for over 1000 exposures; □77)
15	Number of exposures remaining (□77, □600)
16	ISO sensitivity (□137)
17	ISO sensitivity indicator (□137) Auto ISO sensitivity indicator (□245)
18	Aperture (□130, □131)

Viewfinder

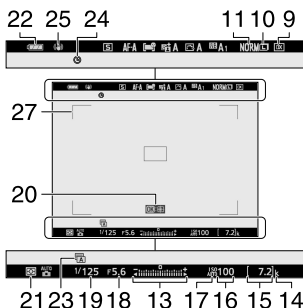

19	Shutter speed (□128, □131)
20	Subject-tracking AF (□109)
21	Metering (□162)
22	Battery indicator (□76)
23	Shutter type (□357)
24	“Clock not set” indicator (□84)
25	Vibration reduction indicator (□171)
26	Touch shooting (□110)
27	AF-area brackets (□103)

Video mode

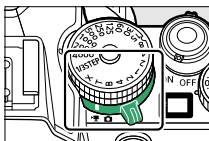

Monitor

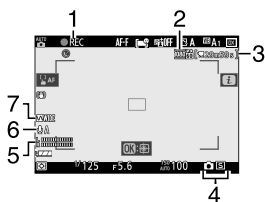

- 1 Recording indicator (□90)
"No video" indicator (□92)
- 2 Frame size and rate/Video quality (□175)
- 3 Time remaining (□90)

Viewfinder

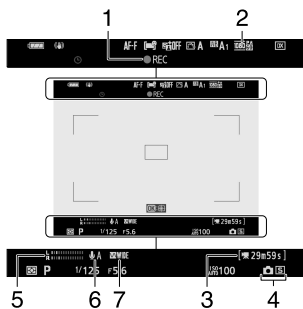

- 4 Release mode (still photography; □335)
- 5 Sound level (□178)
- 6 Microphone sensitivity (□178)
- 7 Frequency response (□338)

Camera controls

Viewfinder

- Placing your eye to the viewfinder activates the eye sensor, switching the display from the monitor to the viewfinder. Note that the eye sensor will also respond to other objects, such as your fingers.

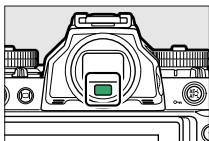

- The viewfinder can be used for menus and playback if desired.

✓ The diopter adjustment control

- The viewfinder can be focused by rotating the diopter adjustment control.

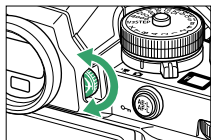

- Be careful not to put your fingers or fingernails in your eye.

✓ Extended use

When using the viewfinder for extended periods, you can select **[Off]** for Custom Setting d7 **[Apply settings to live view]** to ensure that viewfinder brightness and hue are adjusted for ease of viewing.

The (monitor mode) button

Press the  button to cycle between viewfinder and monitor displays.

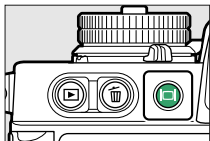

Press the  button to cycle through the displays as follows.

[Automatic display switch]: The camera automatically switches between the viewfinder and monitor displays based on information from the eye sensor.



[Viewfinder only]: The monitor remains blank. The viewfinder is used for shooting, menus, and playback.



[Monitor only]: The monitor is used for shooting, menus, and playback. The viewfinder display will remain blank even if you put your eye to the viewfinder.



[Prioritize viewfinder]: The camera functions in a manner similar to existing digital SLR cameras.



- During photo mode, placing your eye to the viewfinder turns the viewfinder on; the monitor remains off after you take your eye away.
- During video mode or playback or while menus are displayed, the camera automatically switches between the viewfinder and the monitor based on information from the eye sensor.

Monitor mode

You can limit the choice of monitor modes available using the **[Limit monitor mode selection]** item in the setup menu.

The mode selector

Use the mode selector to choose a shooting mode.

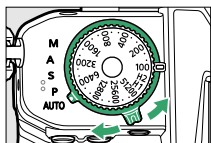

Mode		Description
AUTO (AUTO) (A)	Auto	A simple, “point-and-shoot” mode that leaves the camera in charge of settings (□□85, □□90).
P	Programmed auto	The camera sets shutter speed and aperture for optimal exposure.
S	Shutter-priority auto	You choose the shutter speed; the camera selects the aperture for best results.
A	Aperture-priority auto	You choose the aperture; the camera selects the shutter speed for best results.
M	Manual	You control both shutter speed and aperture.

The shutter-speed dial

In mode **S** or **M**, you can rotate the shutter-speed dial to set the shutter speed.

To select **[X]** or **[T]**, or to change from **[1/3STEP]**, **[X]**, **[T]**, or **[B]**, rotate while pressing the shutter-speed dial lock release.

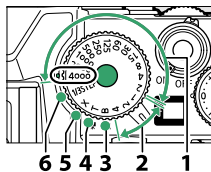

- 1 1/4000 s–1/2 s
- 2 1–4 s (red text)
- 3 **B** (Bulb) (☐134)

- 4 **T** (Time) (☐134)
- 5 **X** (Flash sync) (☐361)
- 6 **1/3STEP** (1/3 step) (☐130)

The command dials

Rotate the command dials to choose settings for aperture or the functions assigned to other camera controls.

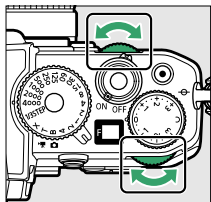

The ISO sensitivity dial

You can rotate the ISO sensitivity dial while pressing the ISO sensitivity dial lock release to adjust the camera's sensitivity to light (ISO sensitivity) according to the amount of light available.

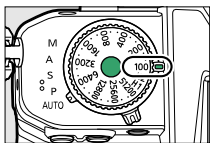

■ Photo mode

ISO sensitivity can be adjusted by holding the ISO sensitivity dial lock release and rotating the ISO sensitivity dial.

- In **AUTO** mode, the setting is fixed at **ISO-A (AUTO)**, and the camera sets the ISO sensitivity automatically.

■ Video mode

You can set the ISO sensitivity only with the following settings. In all other cases, the camera sets the ISO sensitivity automatically.

- Mode: **M**
- **[ISO sensitivity settings] > [Auto ISO control (mode M)]** in the video recording menu: **[Off]**

ISO sensitivity can be adjusted by holding the ISO sensitivity dial lock release and rotating the ISO sensitivity dial.

- Select from values of from **ISO 100 to 25600**. If the ISO sensitivity dial is set to any other value, it will be set to **ISO 25600**.

The exposure compensation dial

You can rotate the exposure compensation dial to alter exposure from the value suggested by the camera. Exposure compensation can be used to make pictures brighter or darker.

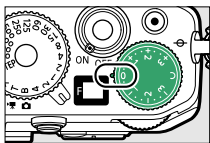

-1 EV



No exposure
compensation



+1 EV

- Higher values make the subject brighter, lower values darker.

Monitor

The orientation and angle of the monitor can be adjusted.

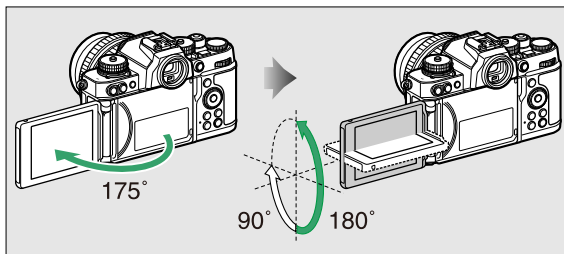

- **Normal shooting**

When shooting normally, use the monitor so that it is facing out and set in the camera body.

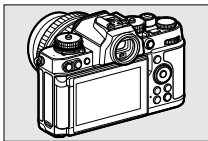

- **Low angle shooting**

Turn the monitor facing up to shoot with the camera at low positions.

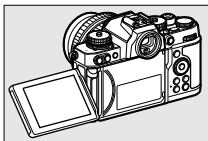

- **High angle shooting**

Turn the monitor facing down to shoot with the camera at high positions.

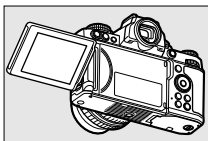

● Self-portrait mode

When the monitor is facing the front of the camera, the camera changes to self-portrait mode (☞52).

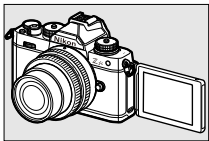

✔ Precautions for the monitor

- When rotating the monitor, rotate slowly within the allowable range. Applying excessive force will result in damage to the camera body and monitor.
 - When you are not using the monitor, turning it facing inward and setting it in the camera body is recommended to prevent damage and dirt.
 - Do not carry the camera by holding the monitor. This could result in damage to the camera.
-

■ Shooting in self-portrait mode

If the monitor is set to the self-portrait mode position, it will switch to self-portrait mode.

The monitor will display an image as if it were reflected on a mirror (inverted image), but the actual image is saved from the perspective of the camera.

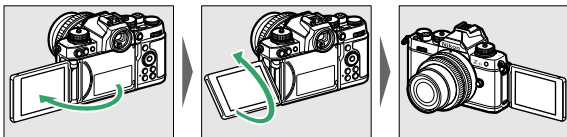

- In self-portrait mode, you can tap the monitor to set the self-timer.

- If you set the exposure compensation dial to [C] in self-portrait mode, you can tap the monitor to set the exposure compensation.
- If you tap the self-timer icon (①), you can set the shutter-release delay and the number of shots.
- If you tap the exposure compensation icon (②), you can change the image brightness.



- Press the shutter-release button halfway to focus. Press the shutter-release button all the way down to take a photo.
- You can use touch AF and touch shutter.
- In video mode, press the video-record button to record video.
- If the monitor is moved from the self-portrait mode position, self-portrait mode ends.

✔ Self-portrait mode

In self-portrait mode, note the following:

- During self-portrait mode, controls other than the power switch, shutter-release button, video-record button, photo/video selector, mode selector, shutter-speed dial, ISO sensitivity dial, and exposure compensation dial are disabled.
 - If no operations are performed for about 1 minute when Custom Setting c3 [**Power off delay**] > [**Standby timer**] is set to less than 1 minute, or for the specified time when set to 1 minute or more, the standby timer will expire.
 - The following settings are fixed.
 - [**Release mode**]: [**Self-timer**]
 - [**Focus mode**] in the video recording menu: [**Full-time AF**]
 - [**Touch controls**] > [**Enable/disable touch controls**]: [**Enable**]
 - The viewfinder cannot be used.
 - The following functions cannot be used.
 - [**Long exposure NR**]
 - [**Auto bracketing**]
 - [**HDR (high dynamic range)**]
 - [**Exposure delay mode**]
 - [**Extended shutter speeds (M)**]
 - When [**Self-portrait mode**] (☐408) in the setup menu is set to [**Disable**], the monitor will not switch to self-portrait mode even if it is set to the self-portrait mode position.
-

Touch controls

The touch-sensitive monitor offers a variety of controls that can be operated by touching the display with your fingers. During viewfinder

photography, touch controls are disabled and cannot be used for focus or the like.

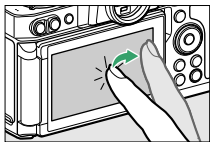

■ Focusing and releasing the shutter

- Touch the monitor to focus on the selected point (touch AF).

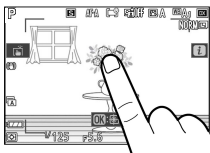



- In photo mode, the shutter will be released when you lift your finger from the display (touch shutter).
- Touch shutter/AF settings can be adjusted by tapping the  icon (□110).



Adjusting settings

- Tap highlighted settings in the display.



- You can then choose the desired option by tapping icons or sliders.
- Tap  or press  to select the chosen option and return to the previous display.



Playback

- Flick left or right to view other pictures during full-frame playback.

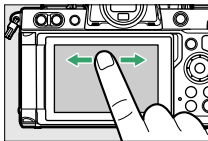

- In full-frame playback, touching the bottom of the display brings up a frame-advance bar. Slide your finger left or right over the bar to scroll rapidly to other pictures.

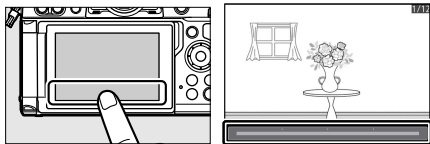

- To zoom in on a picture displayed during full-frame playback, use a stretch gesture or give the display two quick taps. You can adjust the zoom ratio using stretch gestures to zoom in and pinch gestures to zoom out.

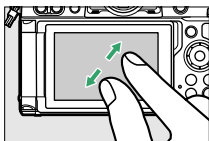

- Use slide gestures to view other parts of the image during zoom.
- Giving the display two quick taps while zoom is in effect cancels zoom.
- To “zoom out” to a thumbnail view, use a pinch gesture during full-frame playback. Use pinch and stretch to choose the number of images displayed from 4, 9, and 72 frames.

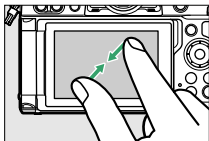

- Using a pinch gesture when 72 frames are displayed selects calendar playback. Use a stretch gesture to return to the 72-frame display.

Viewing videos

- Videos are indicated by a  icon; to start playback, tap the on-screen guide.

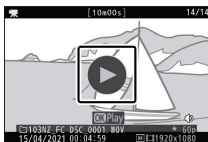

- Tap the display to pause. Tap again to resume.
- Tap  to exit to full-frame playback.

The *i* menu

- Tap the  icon to display the *i* menu during shooting (📖68, 📖145).



- Tap items to view and change options.



Text entry

- When a keyboard is displayed, you can enter text by tapping the keys.



1 Text display area

3 Keyboard selection

2 Keyboard area

- To position the cursor, tap ◀ or ▶ or tap directly in the text display area.
- To cycle through the upper- and lower-case and symbol keyboards, tap the keyboard selection button.

Navigating the menus

- Slide up or down to scroll.

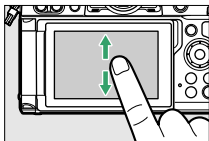

- Tap a menu icon to choose a menu.

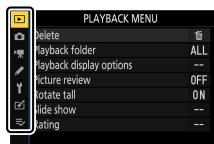

- Tap menu items to display options. You can then choose the desired option by tapping icons or sliders.

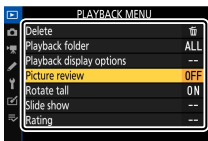

- To exit without changing settings, tap .

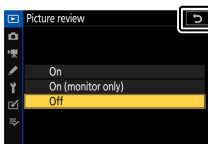

✓ The touch screen

- The touch screen responds to static electricity. It may not respond when touched with fingernails or gloved hands.
- Do not touch the screen with sharp objects.
- Do not use excessive force.
- The screen may not respond when covered with third-party protective films.
- The screen may not respond when touched simultaneously in multiple locations.

✓ Enabling or disabling touch controls

Touch controls can be enabled or disabled using the [**Touch controls**] item in the setup menu.

The DISP button

Use the **DISP** button to cycle through the following displays:

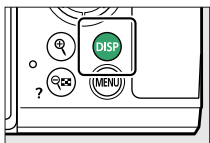
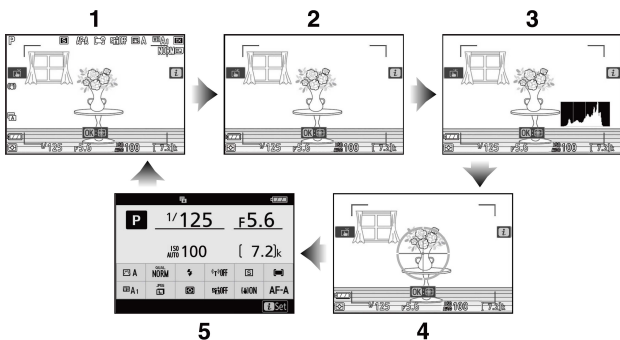

Photo mode



- | | | | |
|---|--------------------|---|----------------------------|
| 1 | Indicators on | 4 | Virtual horizon |
| 2 | Simplified display | 5 | Information display (i530) |
| 3 | Histogram 1, 2 | | |

- 1 Displayed when **[On]** is selected for Custom Setting d7 [**Apply settings to live view**].
- 2 Not displayed if **[On]** is selected for **[Overlay shooting]** during multiple exposure photography.

✔ The viewfinder

The **DISP** button can also be used to choose the information displayed in the viewfinder. Note, however, that the information display does not appear in the viewfinder.

✔ Turning off the information display

In Custom Setting f2 [**Custom controls (shooting)**], you can assign [**Live view info display off**] to turn off the information display at the press of a button. Press it again to turn on the display.

■ Video mode

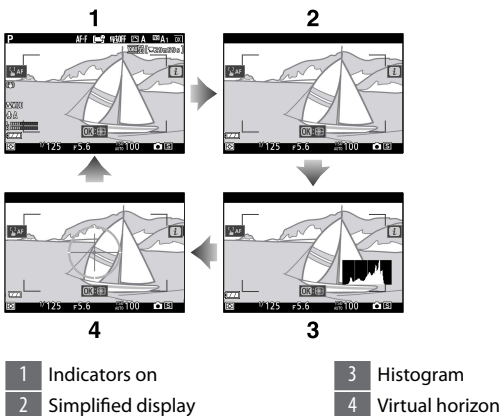



The and (?) buttons

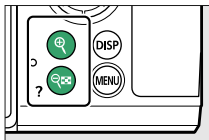



Zoom the display in the monitor in or out during shooting or playback.



■ Shooting

Press  to zoom in on the view through the lens during shooting. Press  to increase the zoom ratio,  (?) to zoom out.

■ Playback

Press  to zoom in on pictures during full-frame playback. Press  to increase the zoom ratio,  (?) to zoom out. Pressing  (?) when the picture is displayed full frame “zooms out” to the thumbnail list. Pressing  (?) when 72 frames are displayed selects calendar playback.

The (O_{II}) button

Lock the focus and exposure when shooting, or protect images during playback.

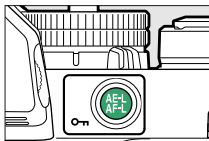

■ Shooting

Lock the focus and exposure at the same time.

■ Playback

Protect the current image.

The MENU button

Press the MENU button to view the menus.

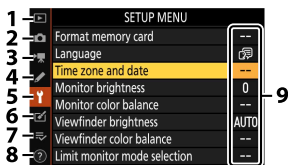
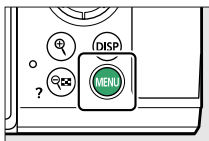

- 1 [PLAYBACK MENU] (☐232)
- 2 [PHOTO SHOOTING MENU] (☐237)
- 3 [VIDEO RECORDING MENU] (☐329)
- 4 [CUSTOM SETTINGS MENU] (☐341)
- 5 [SETUP MENU] (☐391)

- 6 [RETOUCH MENU] (☐424)
- 7 [MY MENU]/[RECENT SETTINGS]* (☐449)
- 8 The ? Help icon (☐68)
- 9 Current settings

* You can choose the menu displayed. The default is [MY MENU].

Using the menus

You can navigate the menu using the multi selector and **OK** button.

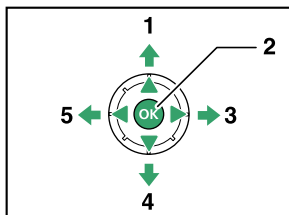

1 Move cursor up

2 Select highlighted item

3 Display sub-menu, select highlighted item, or move cursor right

4 Move cursor down

5 Cancel and return to previous menu, or move cursor left

1 Highlight the icon for the current menu.

Press **OK** to place the cursor in the menu-selection area.

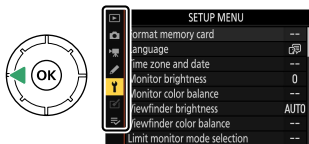

2 Select a menu.

Press  or  to select the desired menu.

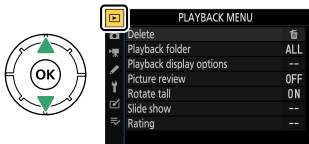

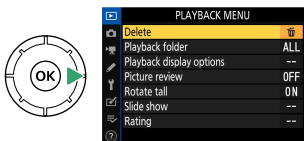

3 Position the cursor in the selected menu.

Press  to position the cursor in the selected menu.



4 Highlight a menu item.

Press  or  to highlight a menu item.

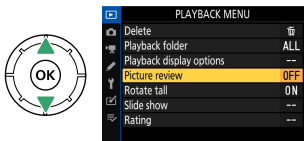

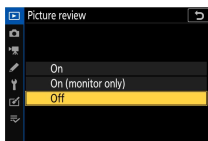

5 Display options.

Press  to display options for the selected menu item.



6 Highlight an option.

Press  or  to highlight an option.

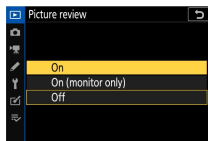

7 Select the highlighted option.







- Press  to select the highlighted option.
- To exit without making a selection, press the **MENU** button.
- To exit the menus and return to shooting mode, press the shutter-release button halfway.

Grayed-out items

Some items and menu options may be unavailable depending on the mode and camera status. Unavailable items are displayed in gray.

✔ The (help) icon

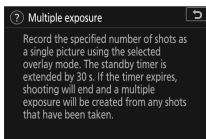
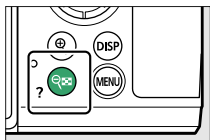

- Where available, a description of the currently-selected item can be viewed by pressing the  (?) button.
- Press  or  to scroll.
- Press  (?) again to return to the menus.



✔ Touch controls

You can also navigate the menu using touch controls ([□□54](#)).

The button (the)

For quick access to frequently-used settings, press the  button or tap the  icon to view the .

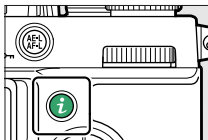

- Different menus are displayed during photo mode and video mode.

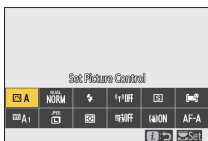

- Options can be viewed by tapping items in the display or by highlighting items and pressing **Ⓢ**; selections can then be made using the multi selector.
- Items for which the camera displays an on-screen guide can be adjusted by highlighting them in the **i** menu and rotating a command dial. In some cases, adjustments can be made using both the main and sub-command dials.



i The playback **i** menu

Pressing the **i** button during playback displays a context-sensitive **i** menu of frequently-used playback options.

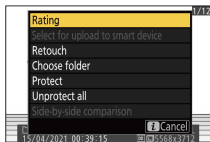

i Customizing the **i** menu

The items displayed in the photo-mode **i** menu can be chosen using Custom Setting f1 or g1 [**Customize **i** menu**].

1 Highlight Custom Setting f1 or g1 [Customize **f** menu] and press **OK**.

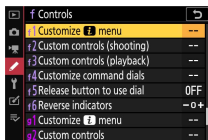

See “The MENU button” (☐64) for information on using the menus.

2 Highlight the position you want to change and press **OK**.



A list of the items available for the selected position will be displayed.

3 Highlight the desired item and press **OK**.

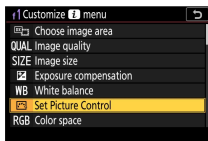

- The item will be assigned to the selected position and the options shown in Step 2 will be displayed.
- Repeat Steps 2 and 3 as desired.

4 Press the MENU button.

Changes will be saved and the Custom Settings menu will be displayed.

The Fn button

Use the Fn button for quick access to selected settings.

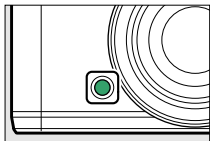

- By default, the Fn button is assigned white balance (☐116).
- The assigned setting can be adjusted by holding the Fn button and rotating the command dial. In some cases, adjustments can be made using both the main and sub-command dials.

■ ■ Choosing roles for the Fn button

The role played by the Fn button can be selected using Custom Setting f2 [**Custom controls (shooting)**] or g2 [**Custom controls**] > [**Fn button**].

1 Highlight Custom Setting f2 [**Custom controls (shooting)**] or g2 [**Custom controls**] and press **OK**.

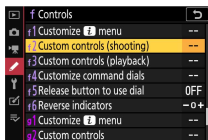

See “The MENU button” (☐64) for information on using the menus.

2 Highlight and press .

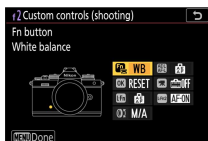

A list of the items available for the Fn button will be displayed.

3 Highlight the desired item and press .

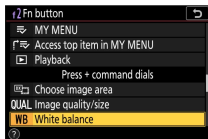

- The item will be assigned to the Fn button and the options shown in Step 2 will be displayed.

4 Press the **MENU** button.

Changes will be saved and the Custom Settings menu will be displayed.

First steps

Attaching the strap

To attach a strap (whether the supplied strap or one that has been purchased separately):

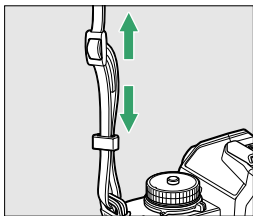
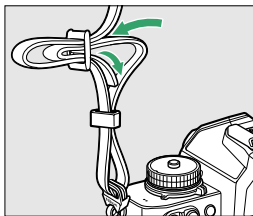
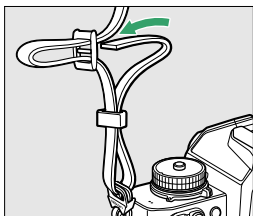
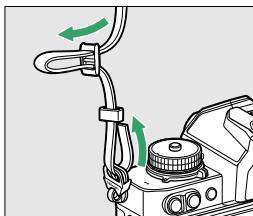

Charging the battery

Charge the supplied EN-EL25 battery in the supplied MH-32 battery charger before use.

✔ The battery and charger

Read and follow the warnings and cautions in “For your safety” (□□28) and “Caring for the camera and battery: Cautions” (□□578).

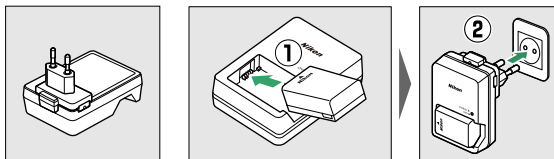

- Plug the charger into a household outlet to charge it. In some countries or regions, the charger may be supplied with the adapter connected. The charger lamp flashes while charging, and lights up when charging is complete.
- An exhausted battery will fully charge in about 2 hours and 30 minutes.

✔ If the CHARGE lamp flashes rapidly

If the **CHARGE** lamp flashes rapidly (8 times a second):

- **A battery charging error has occurred:** Unplug the charger and remove and reinsert the battery.
- **The ambient temperature is too hot or too cold:** Use the battery charger at temperatures within the designated temperature range (0–40 °C/+32–104 °F).

If the problem persists, unplug the charger and end charging. Bring the battery and charger to a Nikon-authorized service representative.

Inserting the battery and a memory card

- Turn the camera off before inserting or removing the battery and memory card.
- Using the battery to keep the orange battery latch pressed to one side, slide the battery into the battery chamber until the latch locks it in place.
- Holding the memory card in the orientation shown, slide it straight into the slot until it clicks into place.

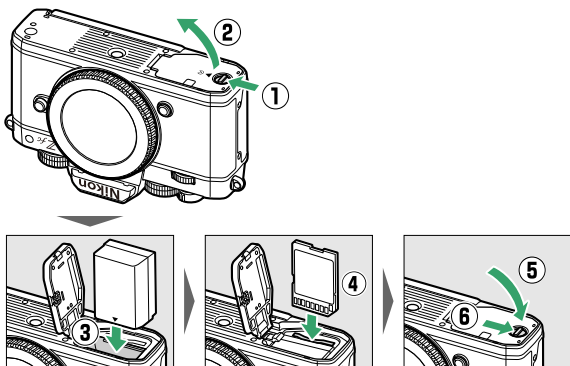

✔ Removing the battery

To remove the battery, turn the camera off and open the battery-chamber/memory card slot cover. Press the battery latch in the direction shown by the arrow to release the battery and then remove the battery by hand.

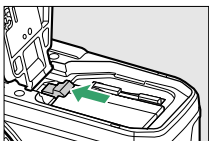

✔ Removing the memory card

After confirming that the memory card access lamp is off, turn the camera off and open the battery-chamber/memory card slot cover. Press the memory card in to eject it (1), and pull it out to remove it (2).

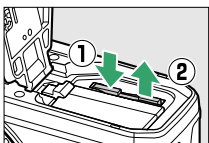

Battery level



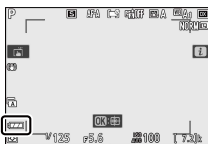

- The battery level is shown in the shooting display while the camera is on.



Monitor



Viewfinder

- The battery level display changes as the battery level diminishes, from  through , and . When the battery level falls to , suspend shooting and charge the battery or ready a spare battery.
- If the message [**Shutter release disabled. Recharge battery.**] is displayed, charge or exchange the battery.

✔ The standby timer

The camera uses a standby timer to help reduce the drain on the battery. If no operations are performed for about 30 seconds, the standby timer will expire and the monitor, viewfinder, and control panel will turn off. A few seconds prior to turning off, the displays will dim. They can be reactivated by pressing the shutter-release button halfway. The length of time before the standby timer expires automatically can be selected using Custom Setting c3 [**Power off delay**] > [**Standby timer**].

Number of exposures remaining

- When the camera is on, the shooting display shows the number of photographs that can be taken at current settings.
- Values over 1000 are rounded down to the nearest hundred. For example, values between 1500 and 1599 are shown as 1.5 k.



Monitor



Viewfinder

Attaching a lens

- The camera can be used with Z mount lenses. The lens generally used in this document for illustrative purposes is a NIKKOR Z DX 16–50mm f/3.5–6.3 VR.
- Be careful to prevent dust entering the camera.
- Confirm that the camera is off before attaching the lens.
 - Remove the camera body cap (①, ②) and rear lens cap (③, ④).

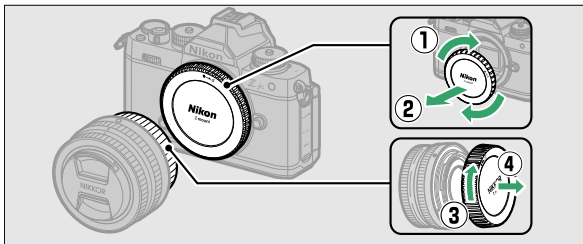

- Align the mounting marks on the camera (⑤) and lens (⑥). Do not touch the image sensor or lens contacts.

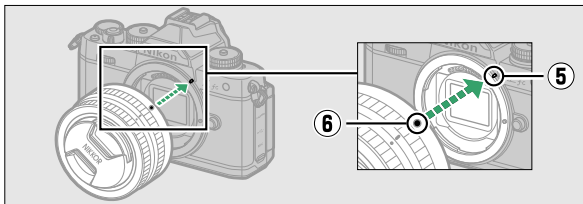

- Rotate the lens as shown until it clicks into place (7).

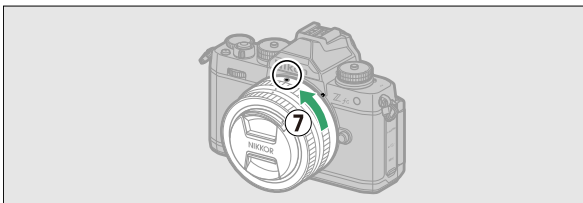

- Remove the front lens cap before taking pictures.

✓ F mount lenses

- Be sure to attach the FTZ mount adapter (available separately) before using F mount lenses.
 - Attempting to attach F mount lenses directly to the camera could damage the lens or image sensor.
-

Detaching lenses

- After turning the camera off, press and hold the lens release button (1) while turning the lens in the direction shown (2).

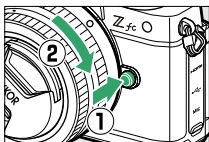

- After removing the lens, replace the lens caps and camera body cap.

Opening the monitor

Slowly rotate the monitor without using excessive force.

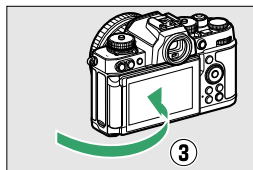
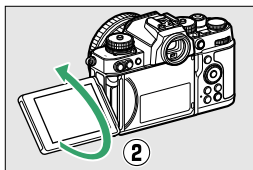
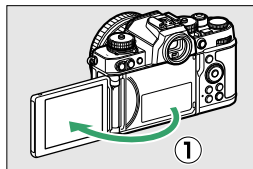
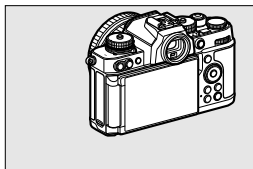

Turning on the camera

When the camera is turned on for the first time, the language selection screen is displayed. Choose a language and then set the camera clock (no other operations can be performed until the clock is set).

1 Turn the camera on.

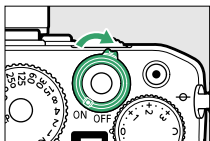

- The [**Language**] selection screen will be displayed.



2 Select a language.

- Press \odot or \ominus to highlight the desired language and press OK (the languages available vary with the country or region in which the camera was originally purchased).
- The [**Time zone**] screen will be displayed.

3 Choose a time zone.

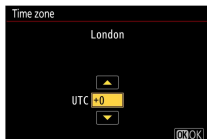

- Press or to choose a time zone and press .
- The display shows the selected cities in the chosen zone and the difference between the time in the chosen zone and UTC.
- The [**Date format**] screen will be displayed.

4 Choose a date format.

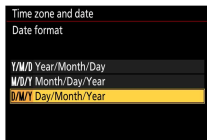

- Highlight the desired date (year, month, and day) display order and press .
- The [**Daylight saving time**] screen will be displayed.

5 Turn daylight saving time on or off.

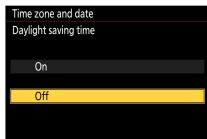

- Highlight [**On**] (daylight saving time on) or [**Off**] (daylight saving time off) and press **OK**.
- Selecting [**On**] advances the clock one hour; to undo the effect, select [**Off**].
- The [**Date and time**] screen will be displayed.

6 Set the clock.

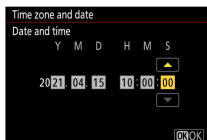

- Press **←** or **→** to highlight date and time items and press **↑** or **↓** to change them.
- Press **OK** to confirm the date and time setting.
- The message [**Done.**] will be displayed and the camera switches to shooting mode.

✔ The ☹ icon

A flashing ☹ icon in the shooting display indicates that the camera clock has been reset. The date and time recorded with new photographs will not be correct; use the **[Time zone and date] > [Date and time]** option in the setup menu to set the clock to the correct time and date. The camera clock is powered by an independent clock battery. The clock battery charges when the main battery is inserted in the camera. It takes about 2 days to charge. Once charged, it will power the clock for about a month.

Basic photography and playback

Taking photographs (AUTO auto)

Select  (auto) mode for simple “point-and-shoot” photography.

✔ Lenses with retractable barrels

Lenses with retractable barrels must be extended before use. Rotate the zoom ring as shown until the lens clicks into the extended position.



1 Select photo mode by rotating the photo/video selector to .

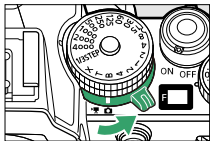

2 Rotate the mode selector to AUTO (.

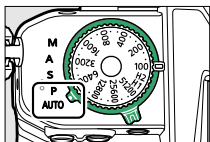

3 Ready the camera.

Holding the handgrip in your right hand and cradling the camera body or lens with your left, bring your elbows in against the sides of your chest.



Landscape (wide)
orientation



Portrait (tall) orientation

4 Frame the photograph.



Position the main subject in the AF-area brackets ([]).

- The AF-area brackets will disappear and a yellow border indicating the focus point appears around the faces of human subjects detected by the camera. If the camera detects the subject's eyes, the yellow focus point will instead appear over one or the other of their eyes.



5 Press the shutter-release button halfway to focus.



- The focus point will be displayed in green when the camera focuses. If the camera is unable to focus, the AF-area brackets will flash.

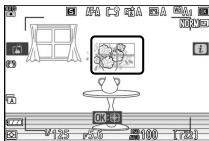

- The AF-assist illuminator may light to assist the focus operation if the subject is poorly lit.
- If the camera detects human faces or eyes, the focus point will light green when the subject is in focus. The focus point will flash in red when the camera does not focus.



✔ **The AF-assist illuminator**

Do not obstruct the AF-assist illuminator while it is lit.

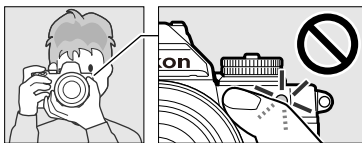

6 Smoothly press the shutter-release button the rest of the way down to take the photograph.



✔ **The memory card access lamp**

The memory card access lamp will light while the photograph is being recorded. **Do not remove the memory card or battery.**

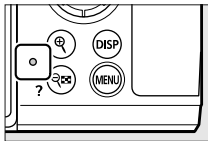

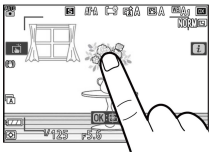

✔ The touch shutter

You can also take a photograph by touching the monitor. Touch your subject to focus and lift your finger to release the shutter.



✔ Zooming in photo mode

Press the  button in photo mode to zoom in on the view (up to about 15×).

- The zoom ratio increases every time you press the  button, and decreases every time you press the  (?) button.
- When using zoom while shooting, a navigation window is displayed at the bottom right of the monitor to show which part of the composition is zoomed in.
- In playback zoom, use the multi selector to move to areas of the frame not visible in the monitor.

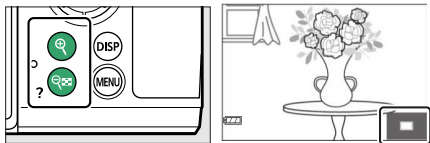

Recording videos (AUTO auto)

AUTO (auto) mode can also be used for simple, “point-and-shoot” video recording.

- 1 Select video mode by rotating the photo/video selector to 。**

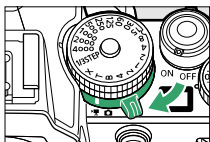

Note that optional flash units cannot be used when the camera is in video mode.

- 2 Rotate the mode selector to AUTO (AUTO).**

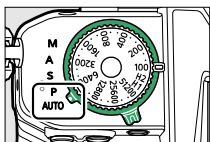

3 Press the video-record button to start recording.

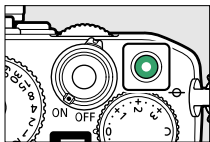

- A recording indicator will be displayed in the monitor. The monitor also shows the time remaining, or in other words the approximate amount of new footage that can be recorded to the memory card.

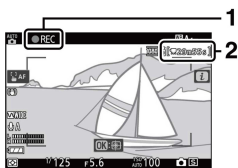

- 1 Recording indicator
- 2 Time remaining

- Sound is recorded via the built-in microphone. Do not cover the microphone during recording.
- If you tap your subject in the monitor during recording, the focus point will track the subject as it moves through the frame (☞109).

4 Press the video-record button again to end recording.

✔ The memory card access lamp

The memory card access lamp will light while the video is being recorded. **Do not remove the memory card or battery.**

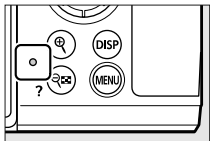

✔ The icon

A  icon indicates that videos cannot be recorded.

✔ Recording videos

- Video recording will end automatically if:
 - The maximum length is reached
 - Another mode is selected
 - The photo/video selector is rotated to 
 - The lens is removed
- Sounds made by the camera may be audible in footage recorded:
 - During autofocus
 - During vibration reduction
 - When power aperture is used

Taking photos in video mode

Photos can be taken in video mode by pressing the shutter-release button all the way down. In **[Release mode (save frame)]** in the video recording menu, you can select single frame or continuous shooting.

- A  icon will flash in the display when a photo is taken.

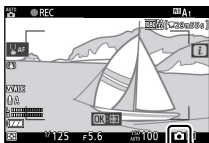

- The frame advance rate for [**Continuous**] in [**Release mode (save frame)**] varies with the option selected for [**Frame size/frame rate**].
- Photos can be taken while recording is in progress. Taking photos does not interrupt video recording. Note, however, that only one photo will be taken each time the shutter-release button is pressed, even if [**Continuous**] is selected for [**Release mode (save frame)**] in the video recording menu.





✔ Taking photos in video mode

- Photo-mode settings do not apply to photos taken in video mode.
- Up to 40 photographs can be taken with each video.
- Note that photos can be taken even when the subject is not in focus.
- Photos are recorded at the dimensions currently selected for video frame size.
- Image quality is fixed at [JPEG fine].
- A  icon indicates that photos cannot be taken.

✔ Photography and video recording

- You may notice the following in the shooting display. These phenomena will also be visible in any photos or footage recorded with the camera.
 - Flicker or banding in scenes lit by such sources as fluorescent, mercury vapor, or sodium lamps
 - Moving objects in the display appear distorted (individual subjects such as trains or cars moving at high speed through the frame may be distorted, or the entire frame may appear distorted when the camera is panned horizontally)
 - Jagged edges, color fringing, *moiré*, and bright spots may appear in the display
 - Bright regions or bands may appear in scenes lit by flashing signs and other intermittent light sources or when the subject is briefly illuminated by a strobe or other bright, momentary light source
 - Flicker occurring when power aperture is used during video recording
 - Note that noise (randomly-spaced bright pixels, fog, or lines) and unexpected colors may appear if you use the  button to zoom in on the view through the lens during recording.
 - When recording, avoid pointing the camera at the sun or other strong light sources. Failure to observe this precaution could result in damage to the camera's internal circuitry.
-



Zooming in video mode

Press the  button in video mode to zoom in on the view (89). Press the  button during video recording to display at 1:1 (100%). Press the  (?) button to cancel zoom.

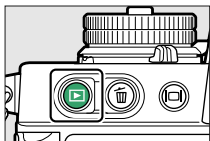

Viewing photos

Press the  button to view photos and videos recorded with the camera in the monitor or viewfinder.



- Press  or , or flick left or right on the monitor to view other images.



- Videos are indicated by a  icon at the upper left of the monitor. Press the  button, or tap the  icon in the monitor to playback videos.

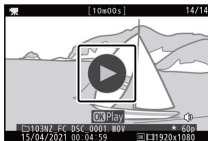

- To end playback and return to shooting mode, press the shutter-release button halfway.

Viewing videos

Monitor display and operation during video playback are as follows.

Monitor display during video playback

The following information is displayed during video playback, allowing you to confirm the video length and playback time. Your approximate position in the video can also be confirmed from the video progress bar.

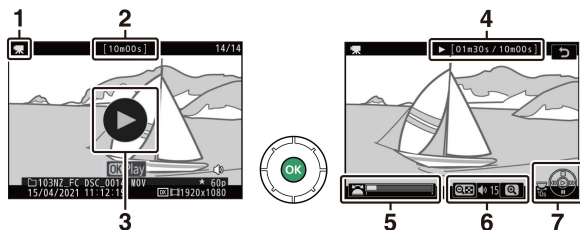

1 icon

2 Length

3 icon

4 Current position/total length

5 Progress bar











6 Volume

7 Guide

Video playback operations

You can perform the following during video playback.

To	Description
Pause	Press to pause playback.
Resume	Press the button to resume playback when playback is paused or during rewind/advance.
Rewind/advance	<ul style="list-style-type: none"> Press to rewind, to advance. Speed increases with each press, from 2x to 4x to 8x to 16x. Keep or pressed to skip respectively to the first frame or last frame. The first frame is indicated by a in the top right corner of the display, the last frame by a .



To	Description
Start slow-motion playback	Press  while the video is paused to start slow-motion playback.
Jog rewind/advance	<ul style="list-style-type: none"> • Press  or  while the video is paused to rewind or advance one frame at a time. • Keep  or  pressed for continuous rewind or advance.
Skip 10 s	Rotate the main command dial one stop to skip ahead or back 10 s.
Skip to last or first frame	Rotate the sub-command dial to skip to the last or first frame.
Adjust volume	Press  to increase volume,  (?) to decrease.
Trim video	To display the [EDIT VIDEO] menu, pause playback and press the  button.
Exit	Press  or  to exit to full-frame playback.
Resume shooting	Press the shutter-release button halfway to return to shooting mode.

Deleting unwanted pictures

Pictures can be deleted as described below. **Note that pictures cannot be recovered once deleted.**

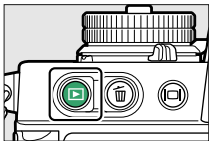

1 Display the picture.

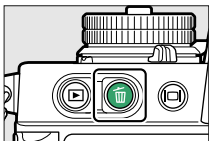

- Press the  button to start playback and press  or  until the desired picture is displayed.

2 Delete the picture.



- Press the  button; a confirmation dialog will be displayed. Press the  button again to delete the image and return to playback.
- To exit without deleting the picture, press .



The playback menu [Delete] item

Use **[Delete]** in the playback menu to:

- Delete multiple pictures
- Delete pictures taken on selected dates
- Delete all pictures in selected folders

Basic settings

Focus

Focus mode

Choose how the camera focuses.

■ ■ Choosing a focus mode

- The focus mode can be selected using the [**Focus mode**] items in the **i** menu, photo shooting menu, and video recording menu (□173, □269, □336).



	Option	Description
AF-A	[AF mode auto-switch]	<ul style="list-style-type: none">• The camera uses AF-S for stationary subjects, and AF-C for moving subjects.• Available only in photo mode.

Option		Description
AF-S	[Single AF]	<ul style="list-style-type: none"> • Use with stationary subjects. When you press the shutter-release button halfway to focus, the focus point will turn from red to green and focus will lock. If the camera fails to focus, the focus point will flash red and the shutter release will be disabled. • At default settings, the shutter can only be released if the camera is able to focus (focus priority).
AF-C	[Continuous AF]	<ul style="list-style-type: none"> • For moving subjects. The camera adjusts focus continuously in response to changes in the distance to the subject while the shutter-release button is pressed halfway. • At default settings, the shutter can be released whether or not the subject is in focus (release priority).
AF-F	[Full-time AF]	<ul style="list-style-type: none"> • The camera adjusts focus continuously in response to subject movement or changes in composition. • When the shutter-release button is pressed halfway, the focus point will turn from red to green and focus will lock. • This option is only available in video mode.
MF	[Manual focus]	Focus manually (□112). The shutter can be released whether or not the subject is in focus.

✔ Autofocus

- The camera may be unable to focus if:
 - The subject contains lines parallel to the long edge of the frame
 - The subject lacks contrast
 - The subject in the focus point contains areas of sharply contrasting brightness
 - The focus point includes night-time spot lighting or a neon sign or other light source that changes in brightness
 - Flicker or banding appears under fluorescent, mercury-vapor, sodium-vapor, or similar lighting
 - A cross (star) filter or other special filter is used
 - The subject appears smaller than the focus point
 - The subject is dominated by regular geometric patterns (e.g., blinds or a row of windows in a skyscraper)
 - The subject is moving
 - The monitor may brighten or darken while the camera focuses.
 - The focus point may sometimes be displayed in green when the camera is unable to focus.
-

✔ Focus position memory

To save the focus position even when the camera is turned off, set [**Save focus position**] in the setup menu to [**On**]. However, some time may be required until the camera can be used after turning it on (depending on zoom operation and changes in temperature, the focus position after turning on the camera may change from the position before the camera was turned off).

AF-area mode

Choose how the camera selects the focus point for autofocus.





- In modes other than [**Auto-area AF**], [**Auto-area AF (people)**], and [**Auto-area AF (animals)**], the focus point can be positioned using the multi selector (☐106).

■ ■ Choosing an AF-area mode

- AF-area mode can be selected using the [**AF-area mode**] items in the **i** menu, photo shooting menu, and video recording menu (□172, □270, □336).



Option	Description
<p>[Pinpoint AF]</p>	<ul style="list-style-type: none"> • With a focus area smaller than that employed for single-point AF, pinpoint AF is used for pinpoint focus on a selected spot in the frame. • Focusing may be slower than with single-point AF. • Recommended for shots involving static subjects, such as buildings, in-studio product photography, or close-ups. • This option is only available when photo mode is selected and [Single AF] is chosen for [Focus mode].
<p>[Single-point AF]</p>	<ul style="list-style-type: none"> • The camera focuses on a point selected by the user. • Use with stationary subjects.
<p>[Dynamic-area AF]</p>	<ul style="list-style-type: none"> • The camera focuses on a point selected by the user. If the subject briefly leaves the selected point, the camera will focus based on information from surrounding focus points. • Use for photographs of athletes and other active subjects that are hard to frame using single-point AF. • This option is only available when photo mode is selected and [AF mode auto-switch] or [Continuous AF] is chosen for focus mode.

Option	Description
 [Wide-area AF (S)]	<ul style="list-style-type: none"> As for single-point AF except that the camera focuses on a wider area.
 [Wide-area AF (L)]	<ul style="list-style-type: none"> Choose for snapshots, subjects that are in motion, and other subjects that are difficult to photograph using single-point AF.
 [Wide-area AF (L-people)]	<ul style="list-style-type: none"> During video recording, wide-area AF can be used for smooth focus when making panning or tilting shots or recording moving subjects.
 [Wide-area AF (L-animals)]	<ul style="list-style-type: none"> If the selected focus area contains subjects at different distances from the camera, the camera will assign priority to the closest subject. The focus areas for [Wide-area AF (L)] are larger than those for [Wide-area AF (S)]. If [Wide-area AF (L-people)] is selected, the camera detects and focuses on human faces or eyes (eye-detection AF/face-detection AF, □106). If [Wide-area AF (L-animals)] is selected, the camera detects and focuses on faces or eyes of dogs and cats (animal-detection AF, □108).

Option		Description
	[Auto-area AF]	<ul style="list-style-type: none"> The camera automatically detects the subject and selects the focus area.
	[Auto-area AF (people)]	<ul style="list-style-type: none"> Use on occasions when you don't have time to select the focus point yourself, for portraits, or for snapshots and other spur-of-the-moment photos.
	[Auto-area AF (animals)]	<ul style="list-style-type: none"> If [Auto-area AF (people)] is selected, the camera detects and focuses on human faces or eyes (eye-detection AF/face-detection AF, □106). If [Auto-area AF (animals)] is selected, the camera detects and focuses on faces or eyes of dogs and cats (animal-detection AF, □108). Subject tracking (□109) can be initiated by pressing the button. Custom Setting f2 [Custom controls (shooting)] or g2 [Custom controls] can be used to configure the Fn button to start subject-tracking AF (□367, □382). Subject-tracking AF can also be assigned to the lens Fn or Fn2 button.

: The center focus point

A dot appears in the focus point when it is in the center of the frame.

Quick focus-point selection

- For quicker focus-point selection, choose [Alternating points] for Custom Setting a4 [Focus points used] to use only a quarter of the available focus points. The number of points available for [Pinpoint AF], [Wide-area AF (L)], [Wide-area AF (L-people)], or [Wide-area AF (L-animals)] does not change even if [Alternating points] is selected.
- You can choose [Select center focus point] for Custom Setting f2 [Custom controls (shooting)] > [OK button] to allow the button to be used to quickly select the center focus point.

Focus-point selection

The multi selector can be used to choose the focus point when an option other than **[Auto-area AF]**, **[Auto-area AF (people)]**, or **[Auto-area AF (animals)]** is selected for AF-area mode (102).

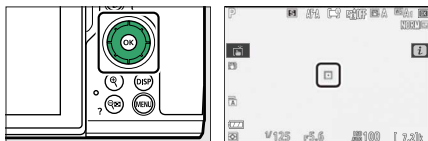

Detecting faces or eyes of portrait subjects (face/eye-detection AF)

If **[Wide-area AF (L-people)]** or **[Auto-area AF (people)]** is selected for **[AF-area mode]** in the photo shooting menu or video recording menu, the camera detects human faces and eyes (eye-detection AF/face-detection AF).

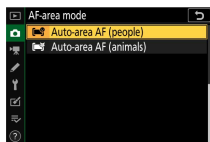

- A yellow border indicating the focus point appears around the faces of human subjects detected by the camera. If the camera detects the

subject's eyes, the yellow focus point will instead appear over one or the other of their eyes.



- If **AF-C** is selected for focus mode or if **AF-A** is selected and the camera is using **AF-C**, the focus point will light yellow when faces or eyes are detected.
- If **AF-S** is selected for focus mode or if **AF-A** is selected and the camera is using **AF-S**, the focus point will turn green when the camera focuses.
- If more than one human face or eye is detected when [**Auto-area AF (people)**] is selected, ◀ and ▶ icons will appear on the focus point. You will be able to position the focus point over a different face or eye by pressing ◀ or ▶.
- If the subject looks away after their face is detected, the focus point will move to track their motion.
- During playback, you can zoom in on the face or eye used for focus by pressing OK.

✔ Face/eye-detection AF

Eye and face detection may not perform as expected if:

- the subject's face occupies a very large or very small proportion of the frame,
 - the subject's face is lit too brightly or too poorly,
 - the subject is wearing glasses or sunglasses,
 - the subject's face or eyes are obscured by hair or other objects, or
 - the subject moves excessively during shooting.
-

■ ■ Focusing on the faces or eyes of animals (animal-detection AF)

If [**Wide-area AF (L-animals)**] or [**Auto-area AF (animals)**] is selected for [**AF-area mode**] in the photo shooting menu or video recording menu, the camera detects the faces and eyes of dogs and cats (animal-detection AF).

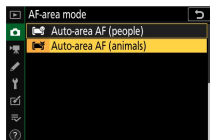

- When the camera detects a face of a dog or cat, a yellow border indicating the focus point will appear around the subject's face. If the camera detects the subject's eyes, the yellow focus point will instead appear over one or the other of their eyes.



- If **AF-C** is selected for focus mode or if **AF-A** is selected and the camera is using **AF-C**, the focus point will light yellow when faces or eyes are detected.
- If **AF-S** is selected for focus mode or if **AF-A** is selected and the camera is using **AF-S**, the focus point will turn green when the camera focuses.
- If [**Auto-area AF (animals)**] is selected and more than one portrait subject or more than one eye is detected, ◀ and ▶ icons will appear on the focus point. You will be able to position the focus point over a different face or eye by pressing ⌚ or ⌚.

- During playback, you can zoom in on the face or eye used for focus by pressing **OK**.

✔ **Animal-detection AF**

- Animal face- and eye-detection may not perform as expected if:
 - the subject's face occupies a very large or very small proportion of the frame,
 - the subject's face is lit too brightly or too poorly,
 - the subject's face or eyes are obscured by fur or other objects,
 - the subject's eyes are similar in color to the rest of their face, or
 - the subject moves excessively during shooting.
- Depending on shooting conditions, the camera may fail to detect the faces or eyes of some breeds when [**Wide-area AF (L-animals)**] or [**Auto-area AF (animals)**] is enabled. Alternatively, the camera may display a border around subjects that are not the faces or eyes of dogs or cats.
- The light from the AF-assist illuminator may adversely affect the eyes of some animals; select [**Off**] for Custom Setting a11 [**Built-in AF-assist illuminator**].

■■ **Subject-tracking AF**

When [**Auto-area AF**], [**Auto-area AF (people)**], or [**Auto-area AF (animals)**] is selected for AF-area mode, the camera can track the subject in the selected focus point.

- Press **OK** to enable focus tracking; the focus point will change to a targeting reticle.



- Position the reticle over the target and press **OK** again to start tracking; the focus point will track the selected subject as it moves

through the frame. To end tracking and select the center focus point, press $\text{\textcircled{AF}}$ again. In photo mode, if subject tracking was initiated in focus mode **AF-C** or **AF-A** by pressing the shutter-release button halfway, the camera will track the subject only while the shutter-release button is pressed; releasing the shutter-release button ends tracking and restores the focus point selected before tracking started.

- To exit subject-tracking mode, press the $\text{\textcircled{Q}}$ (?) button.

✔ Subject tracking

The camera may be unable to track subjects if they:

- are similar in color or brightness to the background,
 - change visibly in size, color, or brightness,
 - are too large or too small,
 - are too dark or too bright,
 - move quickly, or
 - leave the frame or are obscured by other objects.
-

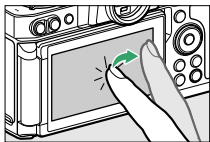

The touch shutter

Touch the display to focus on the selected point. The shutter will be released when you lift your finger from the display.



Tap the icon shown in the illustration to choose the operation performed by tapping the display.



Option	Description
 <p>[Touch shutter/ touch AF]</p>	<ul style="list-style-type: none"> • Touch the display to focus on the selected point and lift your finger to release the shutter. If [Wide-area AF (L-people)], [Wide-area AF (L-animals)], [Auto-area AF (people)], or [Auto-area AF (animals)] is selected for AF-area mode and the camera detects human faces or eyes or the faces or eyes of dogs or cats, the camera will focus on the face or eye* closest to the selected point. • Available only in photo mode.
 <p>[Touch AF]</p>	<ul style="list-style-type: none"> • Touch the display to focus on the selected point. Lifting your finger from the display does not release the shutter. • If [Auto-area AF], [Auto-area AF (people)], or [Auto-area AF (animals)] is selected for AF-area mode, the camera will track the selected subject as it moves through the frame. To switch to a different subject, tap it in the display. If the camera detects human faces or eyes or the faces or eyes of dogs or cats, the camera will focus on and track the face or eye* closest to the selected point.
 <p>[Off]</p>	<p>Touch shutter disabled.</p>

Option	Description
 [Position focus point]	<ul style="list-style-type: none"> • Touch the display to position the focus point. The camera will not focus and lifting your finger from the display will not release the shutter. • If [Auto-area AF], [Auto-area AF (people)], or [Auto-area AF (animals)] is selected for AF-area mode, the camera will track the selected subject as it moves through the frame. To switch to a different subject, tap it in the display. If the camera detects human faces or eyes or the faces or eyes of dogs or cats, the camera will track the face or eye* closest to the selected point.

- * When choosing an eye using touch controls, note that the camera may not focus on the eye on the side you intend. Use the multi selector to choose the desired eye.

✔ Taking pictures using touch shooting options

- Touch controls cannot be used for manual focus.
- The shutter-release button can be used to take pictures when the  icon is displayed.
- Touch controls cannot be used to take photographs during video recording.
- Even if the camera is set to a continuous release mode, touch controls can be used only to take one picture at a time. Use the shutter-release button for burst photography.
- In self-timer mode, focus locks on the selected subject when you touch the monitor and the shutter is released about 10 seconds after you lift your finger from the display. If the number of shots selected is greater than 1, the remaining shots will be taken in a single burst.

Manual focus

Manual focus is available in manual focus mode. Use manual focus when, for example, autofocus does not produce the desired results.

- Position the focus point over your subject and rotate the focus or control ring until the subject is in focus.

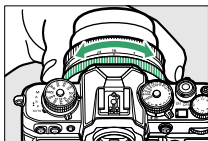

- For greater precision, press the \mathcal{Q} button to zoom in on the view through the lens.

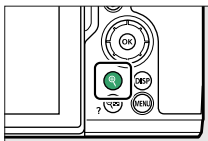

- The focus indicator (●) in the shooting display can be used to confirm whether the subject in the selected focus point is in focus (electronic rangefinding). The focus point will also light green when the subject is in focus.

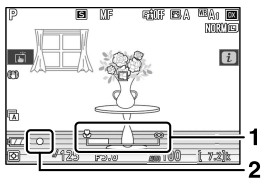

1 Focus distance indicator

2 Focus indicator

Focus indicator	Description
<p style="text-align: center;">● (steady)</p>	<p>The subject is in focus.</p>

Focus indicator	Description
▶ (steady)	The focus point is in front of the subject.
◀ (steady)	The focus point is behind the subject.
▶ ◀ (flashes)	The camera is unable to focus.

- When using manual focus with subjects not suited to autofocus, note that the in-focus indicator (●) may be displayed when the subject is not in focus. Zoom in on the view through the lens and check focus. Use of a tripod is recommended when the camera is having trouble focusing.

✔ Lenses with focus-mode selection

Manual focus mode can be chosen using focus-mode selection controls on the lens (where available).

✔ The focal plane mark and flange-back distance

Focus distance is measured from the focal plane mark (⊖) on the camera body, which shows the position of the focal plane inside the camera (①). Use this mark when measuring the distance to your subject for manual focus or macro photography. The distance between the focal plane and the lens mounting flange is known as the “flange-back distance” (②). On this camera, the flange-back distance is 16 mm (0.63 in.).

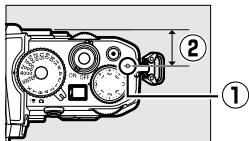

Focus peaking

- If an option other than [**Off**] is selected for Custom Setting d9 [**Focus peaking**], objects that are in focus will be indicated by colored outlines that appear when focus is adjusted manually (focus peaking).

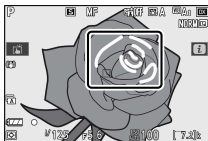

- Note that focus peaking may not be displayed if the camera is unable to detect outlines. Check focus in the shooting display.
-

White balance

White balance ensures that white objects appear white, regardless of the color of the light source. The default setting (auto white balance, or **WB A1**) is recommended with most light sources; if the desired results cannot be achieved with auto white balance, choose another option as described below.

Adjusting white balance

- White balance can be selected using the [**White balance**] items in the **i** menu and the photo shooting menu or video recording menu (☐153, ☐248, ☐332).

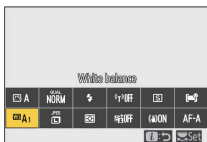

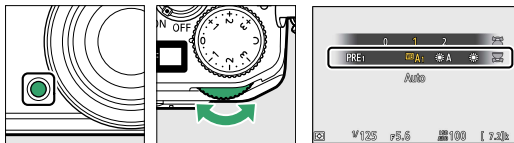

- At default settings, white balance can also be selected by holding the Fn button and rotating the main command dial (☐71).

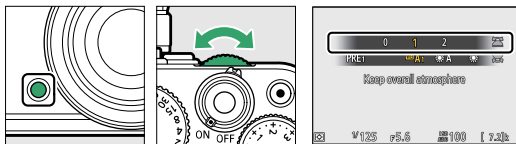

- When **WB A [Auto]** or **Fluorescent** is selected, you can choose a sub-option by holding the Fn button and rotating the sub-command dial.



Option	Color temperature*	Description
WB A [Auto]		White balance is adjusted automatically for optimal results with most light sources. If an optional flash unit is used, white balance will be adjusted in accord with the conditions in effect when the flash fires.
WB A₀ [Keep white (reduce warm colors)]	Approx. 3500–8000 K	Eliminate the warm color cast produced by incandescent lighting.
WB A₁ [Keep overall atmosphere]	Approx. 3500–8000 K	Partially preserve the warm color cast produced by incandescent lighting.
WB A₂ [Keep warm lighting colors]	Approx. 3500–8000 K	Preserve the warm color cast produced by incandescent lighting.
WB A [Natural light auto]	Approx. 4500–8000 K	When used under natural light in place of WB A [Auto] , this option produces colors closer to those seen by the naked eye.

Option	Color temperature*	Description
 [Direct sunlight]	Approx. 5200 K	Use with subjects lit by direct sunlight.
 [Cloudy]	Approx. 6000 K	Use in daylight under overcast skies.
 [Shade]	Approx. 8000 K	Use in daylight with subjects in shade.
 [Incandescent]	Approx. 3000 K	Use under incandescent lighting.
 [Fluorescent]		Use under fluorescent lighting; choose the bulb type according to the light source.
[Cool-white fluorescent]	Approx. 4200 K	
[Day white fluorescent]	Approx. 5000 K	
[Daylight fluorescent]	Approx. 6500 K	
 [Flash]	Approx. 5400 K	Use for flash photography.
 [Choose color temperature]	Approx. 2500–10000 K	<ul style="list-style-type: none"> • Choose the color temperature directly. • To choose a color temperature, hold the Fn button and rotate the sub-command dial.

Option	Color temperature*	Description
PRE [Preset manual]		<ul style="list-style-type: none"> • Measure white balance for the subject or light source or copy white balance from an existing photograph. • To choose a white balance preset, hold the Fn button and rotate the sub-command dial. • To enter direct measurement mode, press and hold the Fn button (□156).

* Values when fine-tuning is set to 0.

✔ **☀A [Natural light auto]**

☀A [Natural light auto] may not produce the desired results under artificial light. Choose ^{WB}A [Auto] or an option that matches the light source.

✔ **White balance fine-tuning**

At settings other than **☑ [Choose color temperature]**, white balance can be fine-tuned. Use the **[White balance]** items in the **i** menu, the photo shooting menu, or video recording menu (□154, □249).

✔ **Studio flash lighting**

^{WB}A [Auto] may not produce the desired results with large studio flash units. Use preset manual white balance or set white balance to ^{WB}⚡ [Flash] and use fine-tuning to adjust white balance.

✔ Color temperature when shooting with **A** or **A**

- The photo info for pictures shot using **A** [Auto] or **A** [Natural light auto] lists the color temperature selected by the camera at the time the picture was taken. You can use this as reference when choosing a value for **A** [Choose color temperature].



- To view shooting data during playback, select [Playback display options] > [Additional photo info] in the playback menu and place a check (✔) next to [Shooting data].

✔ Color temperature

The perceived color of a light source varies with the viewer; some may have a red cast while others appear blue. Color temperature is an objective measure of the color of a light source, expressed in Kelvins (K). The lower the color temperature, the redder the cast (①); the higher the temperature, the bluer the cast (②).

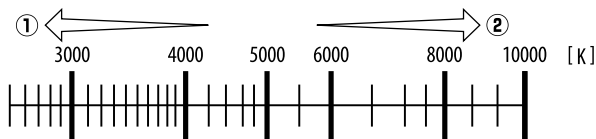

✔ Choosing a color temperature

In general, choose lower values if your pictures have a red cast or to intentionally make pictures bluer, higher values if your pictures are tinged blue or to intentionally make pictures redder.

Silent photography

To enable the electronic shutter and eliminate the noise and vibration caused by operation of the mechanical shutter, select **[On]** for **[Silent photography]** in the photo shooting menu.

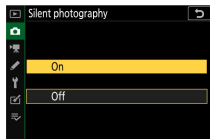

- An icon is displayed while silent photography is in effect.



- The electronic shutter is used, regardless of the option selected for Custom Setting d4 **[Shutter type]**.
- If a release mode other than **[Continuous H (extended)]** is selected, the display will briefly go dark when the shutter is released. This signals that a photo has been taken.
- Regardless of the settings selected for **[Beep options]** in the setup menu, beeps will not sound when the camera focuses or while the self-timer is in operation.
- Enabling silent photography disables some features, including:
 - the flash,
 - long exposure noise reduction,
 - flicker reduction, and
 - high ISO sensitivities (Hi 1, Hi 2).

✔ Silent photography

- Selecting [On] for [Silent photography] does not completely silence the camera. Camera sounds may still be audible, for example during autofocus or aperture adjustment, in the latter case most noticeably at apertures smaller (i.e., at f-numbers higher) than f/5.6.
 - You may notice the following in photographs and in the shooting display:
 - Flicker or banding in scenes lit by such sources as fluorescent, mercury vapor, or sodium lamps
 - Distortion associated with motion (moving subjects may be distorted, or the entire frame may appear distorted if the camera is moved during shooting)
 - Jagged edges, color fringing, *moiré*, and bright spots in the display
 - Bright regions or bands in scenes lit by flashing signs and other intermittent light sources or when the subject is briefly illuminated by a strobe or other bright, momentary light source
 - The frame advance rate for burst photography changes when [On] is selected for [Silent photography] (☐168).
 - Silent photography mutes the shutter, but this does not absolve photographers of the need to respect their subjects' privacy and image rights.
-

Rating pictures

Selected pictures can be rated or marked as candidates for later deletion. Ratings can also be viewed in NX Studio. Protected pictures cannot be rated.

- 1 Press the  button to start playback.**

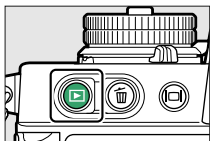

- 2 Select the desired picture and press the  button.**

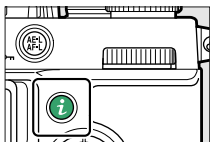

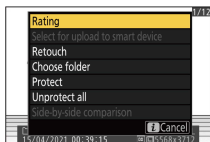

The playback  menu will be displayed.

- 3 Highlight [Rating] and press .**



4 Choose a rating.



- Rotate the main command dial to choose a rating of from zero to five stars, or select  to mark the picture as a candidate for later deletion.
- Press  to select the highlighted option.

Protecting pictures from deletion

Pictures can be protected to prevent their being deleted accidentally. Protected pictures will however be deleted when the memory card is formatted.

- 1 Press the  button to start playback.

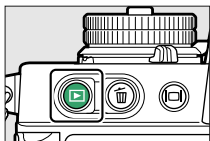

- 2 Select the desired picture and press the  (i) button.

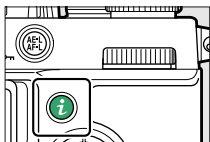

- Protected pictures are marked with a  icon.

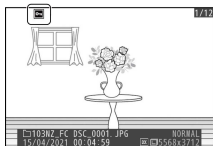

- To remove protection, display or highlight the picture and press the  (i) button again.

Removing protection from all pictures

To remove protection from all pictures in the folder or folders currently selected for **[Playback folder]** in the playback menu, select **[Unprotect all]** in the **i** menu.

Shooting controls

The mode selector

Use the mode selector to choose whether shutter speed and/or aperture can be adjusted manually or are set automatically by the camera.

Using the mode selector

Use the mode selector to choose a shooting mode.

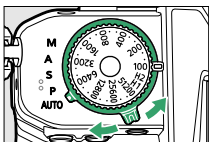

Mode		Description
AUTO (AUTO) α	Auto	A simple, “point-and-shoot” mode that leaves the camera in charge of settings (□□85, □□90).
P	Programmed auto	The camera sets shutter speed and aperture for optimal exposure.
S	Shutter-priority auto	Use to freeze or blur motion. You choose the shutter speed; the camera selects the aperture for best results.
A	Aperture-priority auto	Use to blur backgrounds or bring both foreground and background into focus. You choose the aperture; the camera selects the shutter speed for best results.

Mode		Description
M	Manual	You control both shutter speed and aperture. Set shutter speed to “bulb” or “time” for long time-exposures.

P (programmed auto)

- In this mode, the camera automatically adjusts shutter speed and aperture according to a built-in program to ensure optimal exposure in most situations.
- Different combinations of shutter speed and aperture that produce the same exposure can be selected by rotating the main command dial (“flexible program”).
 - While flexible program is in effect, a flexible program indicator (✳) is displayed.

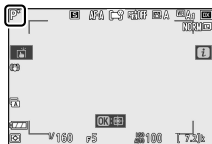

- To restore default shutter speed and aperture settings, rotate the main command dial until the indicator is no longer displayed. Flexible program also ends when the mode dial is rotated to another setting or the camera is turned off.

S (shutter-priority auto)

- In shutter-priority auto, you choose the shutter speed while the camera automatically adjusts aperture for optimal exposure. Choose

fast shutter speeds to “freeze” motion, slow shutter speeds to suggest motion by blurring moving objects.



- Rotate the shutter-speed dial to set the shutter speed.
- To select **[X]** or **[T]**, or to change from **[1/3STEP]**, **[X]**, **[T]**, or **[B]**, rotate while pressing the shutter-speed dial lock release.

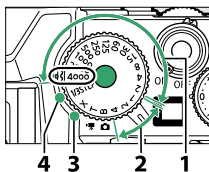

1 1/4000 s–1/2 s

2 1–4 s (red text)

3 **X** (Flash sync) (☐361)

4 **1/3STEP** (1/3 step) (☐130)

- In mode **S**, long exposures (☐134) are not available even if the shutter-speed dial is set to **[B]** (Bulb) or **[T]** (Time). To perform long exposures, select mode **M**.

■ Selecting shutter speed in step sizes of 1/3 (modes S and M)

If the shutter-speed dial is set to [1/3STEP], you can use the main command dial to change the shutter speed.

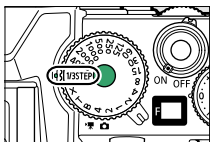

- Shutter speed can be set to values between 1/4000 and 30 s in step sizes of 1/3, or [X]. In mode **M**, you can also select [B] (Bulb) or [T] (Time).
- You can set the shutter speed by means other than the shutter-speed dial as follows.
 - Touch controls (□54)
 - Touch controls in self-portrait mode (□52)

A (aperture-priority auto)

- In aperture-priority auto, you choose the aperture while the camera automatically adjusts shutter speed for optimal exposure.

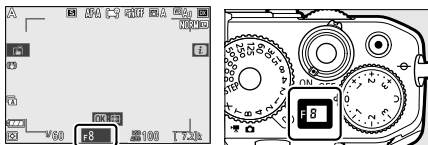

- Aperture can be adjusted by rotating the sub-command dial.
- The minimum and maximum values for aperture vary with the lens.

✔ Video mode exposure settings

The following video settings can be adjusted during recording:

Mode	Aperture	Speed	ISO sensitivity
P, S ¹	—	—	— ²
A	✓	—	— ²
M	✓	✓	✓ ³

- 1 Exposure control in shooting mode **S** is the same as in mode **P**.
- 2 The upper limit for ISO sensitivity can be selected using the **[ISO sensitivity settings]** > **[Maximum sensitivity]** item in the video recording menu.
- 3 If **[On]** is selected for **[ISO sensitivity settings]** > **[Auto ISO control (mode M)]** in the video recording menu, the upper limit for ISO sensitivity can be selected using **[Maximum sensitivity]**.

M (manual)

- You control both shutter speed and aperture. Choose this mode for long time-exposures of such subjects as fireworks or the night sky (“Bulb” or “Time” photography, □134).
- Shutter speed (②) and aperture (③) can be adjusted with reference to the exposure indicators (①).

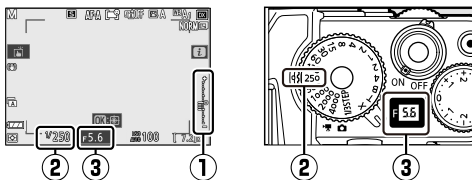

■ Shutter speed

- Rotate the shutter-speed dial to set the shutter speed.

- To select **[X]** or **[T]**, or to change from **[1/3STEP]**, **[X]**, **[T]**, or **[B]**, rotate while pressing the shutter-speed dial lock release.
- If the shutter-speed dial is set to **[1/3STEP]**, you can use the main command dial to change the shutter speed. Shutter speed can also be set to 15 s or 30 s (□130).

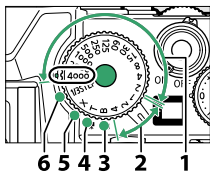

- | | |
|---|------------------------|
| 1 | 1/4000 s–1/2 s |
| 2 | 1–4 s (red text) |
| 3 | B (Bulb) (□134) |

- | | |
|---|----------------------------------|
| 4 | T (Time) (□134) |
| 5 | X (Flash sync) (□361) |
| 6 | 1/3STEP (1/3 step) (□130) |

■ Aperture

- Aperture can be adjusted by rotating the sub-command dial.
- The minimum and maximum values for aperture vary with the lens.

✔ Exposure indicators

- The difference between the exposure value resulting from your setting combination of the shutter speed, aperture, and ISO sensitivity, and the appropriate exposure value measured by the camera, is displayed in the monitor and viewfinder. These “exposure indicators” are displayed as follows.

Display	Optimal exposure	Underexposed by $\frac{1}{3}$ EV	Overexposed by over $3 \frac{1}{3}$ EV
Monitor			
Viewfinder			

- If exposure compensation was performed in mode **M**, the reference value for proper exposure in the exposure indicator changes.

✔ Exposure warning

The displays will flash if the selected settings exceed the limits of the exposure metering system.

✔ Shutter speed extension

If Custom Setting d5 [**Extended shutter speeds (M)**] is set to [**On**], you can select a shutter speed of up to 900 s (15 min) in mode **M** when the shutter-speed dial is set to [**1/3STEP**].

- If you extend the shutter speed, the exposure indicator will not be displayed.

✔ Auto ISO sensitivity control (mode M)

If auto ISO sensitivity control (☐☐245, ☐☐331) is enabled, ISO sensitivity will automatically be adjusted for optimal exposure at the selected shutter speed and aperture.

■ Long time-exposures

The camera offers two options for long time-exposures: “Bulb” and “Time”. Long time-exposures can be used for pictures of fireworks, night scenery, the stars, or moving lights.



A 35-second exposure shot at a shutter speed of “Bulb” and an aperture of f/25

Shutter speed	Description
Bulb	The shutter remains open while the shutter-release button is held down.

Shutter speed	Description
Time	The exposure starts when the shutter-release button is pressed and ends when the button is pressed a second time.

1 Keep the camera steady, for example by using a tripod.

2 Rotate the mode selector to M.

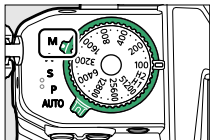

3 Rotate the shutter-speed dial and set the shutter speed to Bulb ("Bulb") or Time ("Time").

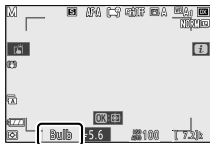
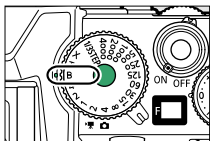

Bulb



Time

- If the shutter-speed dial is set to [1/3STEP], use the main command dial to set it to Bulb or Time.

4 Focus and start the exposure.

- **“Bulb”**: Press the shutter-release button all the way down to start the exposure. Keep the shutter-release button pressed during the exposure.
- **“Time”**: Press the shutter-release button all the way down to start the exposure.

5 End the exposure.

- **“Bulb”**: Lift your finger from the shutter-release button.
- **“Time”**: Press the shutter-release button all the way down a second time.

✓ Long time-exposures

- Note that “noise” (bright spots, randomly-spaced bright pixels or fog) may be present in long exposures.
 - Bright spots and fog can be reduced by choosing [On] for [Long exposure NR] in the photo shooting menu.
 - Nikon recommends using a fully-charged battery or an optional charging AC adapter to prevent loss of power during long exposures.
 - Use of a tripod is recommended to reduce blur.
 - If you are using the optional ML-L7 Remote Control, time photography will be performed even during bulb photography.
-

The ISO sensitivity dial

The camera's sensitivity to light (ISO sensitivity) can be adjusted according to the amount of light available. In general, choosing higher values allows faster shutter speeds at the same aperture.

Adjusting ISO sensitivity

- Hold the ISO sensitivity dial lock release and rotate the ISO sensitivity dial.

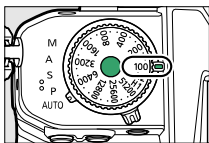

- The option currently selected is shown in the display during shooting.



Photo mode

- Choose from values of from ISO 100 to 51200. You can set the ISO sensitivity dial to **[H1]** (Hi 1) for about one step higher, or **[H2]** (Hi 2) for about two steps higher from ISO 51200.
- In mode , the setting is fixed at ISO-A (AUTO), and the camera automatically adjusts ISO sensitivity.
- If **[Silent photography]** in the photo shooting menu is set to **[On]**, ISO sensitivities **[H1]** (Hi 1) and **[H2]** (Hi 2) cannot be used. If the ISO

sensitivity dial is set to **[H1]** or **[H2]**, the ISO sensitivity will be set to ISO 51200.

✔ **Auto ISO sensitivity control when taking photos**

If you set **[ISO sensitivity settings]** (☐245) > **[Auto ISO sensitivity control]** in the photo shooting menu to **[On]**, the camera will automatically change the ISO sensitivity when proper exposure cannot be obtained with the ISO sensitivity set in modes **P**, **S**, **A**, and **M**.

■ **Video mode**

- You can adjust the ISO sensitivity only under the following settings. In all other cases, the camera automatically adjusts ISO sensitivity.
 - Mode: **M**
 - **[ISO sensitivity settings]** > **[Auto ISO control (mode M)]** in the video recording menu: **[Off]**
- Choose from values of from ISO 100 to 25600. If the ISO sensitivity dial is set to any other value, it will be set to ISO 25600.

✔ **High ISO sensitivities**

The higher the ISO sensitivity, the less light needed to make an exposure, allowing pictures to be taken when lighting is poor and helping prevent blur when the subject is in motion. Note, however, that the higher the sensitivity, the more likely the image is to be affected by “noise” in the form of randomly-spaced bright pixels, fog, or lines.

✔ **H1 and H2**

A setting of **[H1]** (Hi 1) corresponds to an ISO sensitivity approximately 1 EV higher than ISO 51200 (equivalent to ISO 102400) and **[H2]** (Hi 2) to an ISO sensitivity approximately 2 EV higher (equivalent to ISO 204800). Note that pictures taken at these settings are particularly prone to “noise” in the form of randomly-spaced bright pixels, fog, or lines.

The exposure compensation dial

Use this button to alter exposure from the value suggested by the camera. Exposure compensation can be used to make pictures brighter or darker.



-1 EV



No exposure
compensation





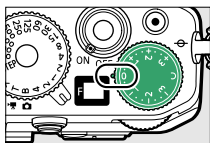

+1 EV

Adjusting exposure compensation

- Rotate the exposure compensation dial.



- Exposure compensation can be adjusted in the range -3 to $+3$ EV in steps of $1/3$ EV.
- Higher values make the subject brighter, lower values darker.
- To cancel exposure compensation, set the exposure compensation dial to **[0]**.
- At values other than ± 0.0 , the camera displays a  icon and the exposure indicator (133) in photo mode or a  icon in video mode. You can check the compensation value on the information display (61) or **i** menu when taking photos, and on the **i** menu when recording videos. To check the compensation value in the **i** menu,

select Custom Setting f1 or g1 [**Customize i menu**] and assign [**Exposure compensation**] to the **i** menu (☞69).

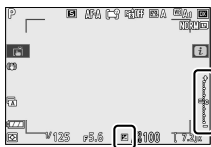

Monitor



Viewfinder

Setting through means other than the exposure compensation dial

If you set the exposure compensation dial to **[C]**, you can adjust the exposure compensation through other means as follows.

Values between -5 EV and +5 EV are available for photos, and between -3 EV and +3 EV for videos.

- [**Easy exposure compensation**] (☞352)
- **i** menu (☞145)
- Touch controls in self-portrait mode (☞52)
- Lens control ring (☞367, ☞382)

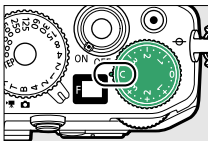

✔ **Mode M**

- In mode **M**, exposure compensation affects only the exposure indicator; shutter speed, aperture, and ISO sensitivity do not change. The overall brightness of the image also does not change.
- When auto ISO sensitivity control (□245, □331) is in effect, ISO sensitivity is automatically adjusted according to the value selected for exposure compensation, and the overall brightness of the image changes.

✔ **Using a flash**

When an optional flash unit is used, exposure compensation affects both flash level and exposure, altering the brightness of both the main subject and the background. Custom Setting e3 [**Exposure comp. for flash**] can be used to restrict the effects of exposure compensation to the background only.

The AE-L/AF-L (O π) button

Locks focus and exposure at the same time.

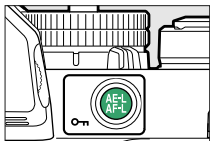

Exposure lock

- Exposure lock can be used to recompose shots after metering a subject that will not be in the selected focus area in the final composition.
- Exposure lock is particularly effective with spot and center-weighted metering.

Focus lock

- Use focus lock to lock focus on the current subject when **AF-C** is selected for focus mode.
- When using focus lock, choose an AF-area mode other than [**Auto-area AF**], [**Auto-area AF (people)**], or [**Auto-area AF (animals)**].

Locking focus and exposure

- 1** Position the subject in the selected focus point and press the shutter-release button halfway to set focus and exposure.

2 Press the **AE-L** (**OK**) button.

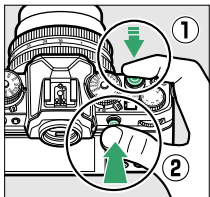

- Focus and exposure will lock while pressing the **AE-L** (**OK**) button. Exposure will not change even when the composition is altered.
- An **AE-L** icon will be displayed in the monitors.

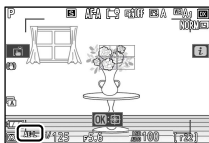

3 Keeping the **AE-L** (**OK**) button pressed, recompose the photograph and shoot.



Do not change the distance between the camera and the subject. If the distance to the subject changes, release the lock and focus again at the new distance.



✔ **Locking focus when AF-S is selected for focus mode or when AF-A is selected and you are shooting in AF-S**

Focus locks while the shutter-release button is pressed halfway. You can also lock focus by pressing the AE-L/AF-L (**On**) button.

✔ **Locking exposure with the shutter-release button**

If [**On (half press)**] is selected for Custom Setting c1 [**Shutter-release button AE-L**], exposure will lock while the shutter-release button is pressed halfway.

✔ **Taking multiple shots at the same focus distance**

- If you locked focus by pressing the AE-L/AF-L (**On**) button, focus will remain locked between shots if you keep the AE-L/AF-L (**On**) button pressed.
 - Focus will also remain locked if you keep the shutter-release button pressed halfway between shots.
-

The *i* menu

The *i* menu

This menu is used for quick access to frequently-used settings. To view the menu, press the *i* button.

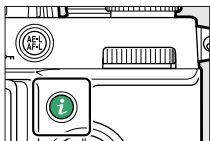

- Highlight items using the multi selector and press \odot to view options. Highlight the desired option and press \odot to select and return to the *i* menu.

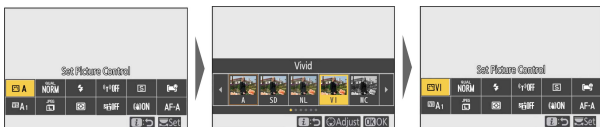

- To cancel and return to the previous display, press the *i* button.

✔ The command dials

- In some cases, the setting for the item currently highlighted in the **i** menu can be chosen by rotating the main command dial. Options for the selected setting, if any, can be selected by rotating the sub-command dial.



- Some items can be adjusted by rotating either dial.
 - Press **OK** to save changes. You can also save changes by pressing the shutter-release button halfway or highlighting another item.
-

Still images

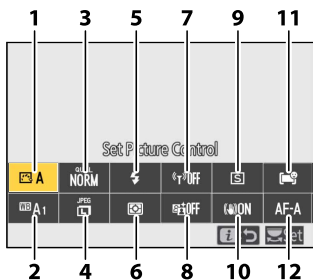

1 Set Picture Control (☐147)

2 White balance (☐153)

3 Image quality (☐160)

4 Image size (☐161)

5 Flash mode (☐162)

6 Metering (☐162)

7 Wi-Fi connection (☐164)

8 Active D-Lighting (☐164)

9 Release mode (☐166)









10 Vibration reduction (☐171)

11 AF-area mode (☐172)



12 Focus mode (☐173)

Set Picture Control

Choose image processing (“Picture Control”) options for new photos according to the scene or your creative intent.

Option	Description
 [Auto]	<ul style="list-style-type: none"> • The camera automatically adjusts hues and tones based on the [Standard] Picture Control. • The complexions of portrait subjects will appear softer than in pictures taken with the [Standard] Picture Control. • In outdoor shots, elements such as the foliage and sky will appear more vivid than in pictures taken with the [Standard] Picture Control.
 [Standard]	Standard processing for balanced results. Recommended for most situations.
 [Neutral]	Minimal processing for natural results. Choose for photographs that will later be processed or retouched.
 [Vivid]	Pictures are enhanced for a vivid, photoprint effect. Choose for photographs that emphasize primary colors.
 [Monochrome]	Take monochrome photographs.
 [Portrait]	Smooth complexions for natural-looking portraits.
 [Landscape]	Shoot vibrant landscapes and cityscapes.
 [Flat]	Details are preserved over a wide tone range, from highlights to shadows. Choose for photographs that will later be extensively processed or retouched.

	Option	Description
01 – 20	[Creative Picture Control] (Creative Picture Control)	<ul style="list-style-type: none"> • Creative Picture Controls offer unique combinations of hue, tone, saturation, and other settings tuned for particular effects. • Choose the type from [Dream], [Morning], [Pop], [Sunday], [Somber], [Dramatic], [Silence], [Bleached], [Melancholic], [Pure], [Denim], [Toy], [Sepia], [Blue], [Red], [Pink], [Charcoal], [Graphite], [Binary], or [Carbon].

- To view Picture Control settings, highlight a Picture Control and press . Any changes to fine-tuning options can be previewed in the display (150).



- The option currently selected is shown in the display during shooting.



■ ■ Modifying Picture Controls

Highlighting [**Set Picture Control**] in the **i** menu and pressing **OK** displays a Picture Control list. Highlight a Picture Control and press **OK** to preview the effect in the display.



- Press **▲** or **▼** to highlight settings. Press **◀** or **▶** to choose a value in increments of 1, or rotate the sub-command dial to choose a value in increments of 0.25.
- The options available vary with the Picture Control selected.
- To abandon any changes and start over from default settings, press the **Trash** button.
- Press **OK** to save changes and return to the **i** menu.
- Picture Controls that have been modified from default settings are indicated by an asterisk ("*").



✓ The Δ indicator

The Δ indicator under the value display in the Picture Control setting menu indicates the previous value for the setting.



✓ [A] (auto)

- Selecting the **A** (auto) option available for some settings lets the camera adjust the setting automatically.
- Results vary with exposure and the position of the subject in the frame.

✓ The “A Auto” Picture Control

Settings can be adjusted in the range [A-2] to [A+2].



Picture Control settings

Option	Description
[Effect level]	Mute or heighten the effect of Creative Picture Controls.
[Quick sharp]	Quickly adjust levels for balanced [Sharpening], [Mid-range sharpening], and [Clarity]. These parameters can also be adjusted individually.
[Sharpening]	Control the sharpness of details and outlines.
[Mid-range sharpening]	Adjust the sharpness of patterns and lines in the range between [Sharpening] and [Clarity].
[Clarity]	Adjust overall sharpness and the sharpness of thicker outlines without affecting brightness or dynamic range.

Option	Description
[Contrast]	Adjust contrast.
[Brightness]	Raise or lower brightness without loss of detail in highlights or shadows.
[Saturation]	Control the vividness of colors.
[Hue]	Adjust hue.
[Filter effects]	Simulate the effect of color filters on monochrome pictures.
[Toning]	Choose the tint used in monochrome pictures. Pressing  when an option other than [B&W] (black-and-white) is selected displays saturation options.
[Toning] (Creative Picture Control)	Choose the shade of color used for Creative Picture Controls.

[Filter effects]

Choose from the following [Filter effects]:

Option	Description
[Y] (yellow)*	These options enhance contrast and can be used to tone down the brightness of the sky in landscape photographs. Orange [O] produces more contrast than yellow [Y], red [R] more contrast than orange.
[O] (orange)*	
[R] (red)*	
[G] (green)*	Green softens skin tones. Use for portraits and the like.

* The term in parentheses is the name of the corresponding third-party color filter for black-and-white photography.

White balance

Adjust white balance. For more information, see “White balance” in “Basic settings” (☰116).

Option	Option
WB A [Auto]	☀ [Incandescent]
WB A0 [Keep white (reduce warm colors)]	☀ [Fluorescent]
WB A1 [Keep overall atmosphere]	[Cool-white fluorescent]
WB A2 [Keep warm lighting colors]	[Day white fluorescent]
☀ A [Natural light auto]	[Daylight fluorescent]
☀ [Direct sunlight]	WB ⚡ [Flash]
☁ [Cloudy]	☑ [Choose color temperature]
🏠 [Shade]	PRE [Preset manual]

- Pressing  when **WB A [Auto]** or **☀ [Fluorescent]** is highlighted displays sub-options for the highlighted item.



- The option currently selected is shown in the display during shooting.



■ Fine-tuning white balance

Pressing **OK** when **[White balance]** is highlighted in the **i** menu displays a list of white balance options. If an option other than **[Choose color temperature]** is highlighted, fine-tuning options can be displayed by pressing **Down Arrow**. Any changes to fine-tuning options can be previewed in the display.

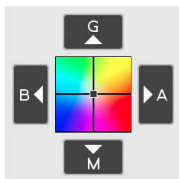

- G** Increase green
- B** Increase blue
- A** Increase amber
- M** Increase magenta

- Tap the arrows in the display or use the multi selector to fine-tune white balance.
- Press **OK** to save changes and return to the **i** menu.
- If white balance has been fine-tuned, an asterisk (“*”) will be displayed in the white balance icon.



■ ■ Choosing a color temperature

Pressing **OK** when **[White balance]** is highlighted in the **i** menu displays a list of white balance options. When **[Choose color temperature]** is highlighted, color temperature options can be viewed by pressing **OK**.

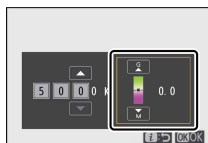



Value for **Amber–Blue** axis Value for **Green–Magenta** axis

- Press **▲** or **▼** to highlight digits on the A–B (amber–blue) axis. You can also highlight the G–M (green–magenta) axis.
- Press **←** or **→** to edit the selected item.
- Press **OK** to save changes and return to the **i** menu.
- If a value other than 0 is selected for the green (G)–magenta (M) axis, an asterisk (“*”) will appear in the white balance icon.

✔ Color-temperature selection

- Do not use color-temperature selection with fluorescent light sources; instead, use the  [Fluorescent] option.
 - When using color-temperature selection with other light sources, take a test shot to determine if the selected value is appropriate.
-

▬▬ Preset manual

White balance settings such as  **A** [Auto],  [Incandescent], and  [Choose color temperature] may fail to produce the desired results under mixed lighting or lighting with a strong color cast. Should this occur, white balance can be set to a value measured under the light source used in the final photograph. The camera can store up to six values for preset manual white balance.

- 1** Select [White balance] in the **i** menu, then highlight **PRE** [Preset manual] and press .



- 2** Select a preset.



- Select from presets **[d-1]** through **[d-6]**.
- Press  to save changes and return to the **i** menus.

3 Highlight [White balance] in the \mathcal{Z} menu and hold the M button to initiate direct measurement mode.

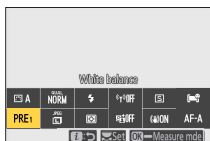

- A PRE indicator will flash in the shooting display.

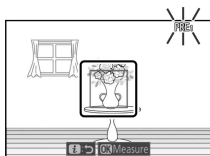

- The white balance target (□) appears in the center of the frame.

4 Position the white balance target (□) over a white or gray object and measure a value for preset manual white balance.

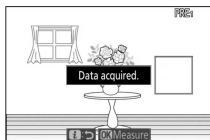

- Position the target (□) using the multi selector.
- To measure white balance, press the shutter-release button all the way down or press **OK**.
- You can also position the target and measure white balance by tapping the display.
- You cannot move □ if an optional flash unit is attached. Frame the shot so that the white or gray reference object is in the center of the display.
- If the camera is unable to measure white balance, a message will be displayed and the camera will return to direct measurement mode. Try measuring white balance again, for example with the target (□) positioned over a different area of the subject.

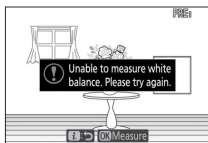

5 Press the **i** button to exit direct measurement mode.

✔ The preset manual white balance menu

The preset manual white balance menu can be accessed by selecting **[White balance]** > **PRE [Preset manual]** in the photo shooting menu. The preset manual white balance menu offers options for copying values for preset manual white balance from an existing photograph or adding comments to or protecting white balance presets.

✔ Protected presets

White balance presets indicated by **On** icons are protected and cannot be changed.

✔ Preset manual: Selecting a preset

- At shipment, presets d-1 through d-6 are set to 5200 K, equivalent to the **☀ [Direct sunlight]** white balance option.
- White balance presets can be viewed by selecting **[White balance]** > **PRE [Preset manual]** in the photo shooting menu. To recall a stored value, highlight a preset using the multi selector and press **Ⓜ**.



✔ Direct measurement mode

Direct measurement mode will end if no operations are performed in the time selected for Custom Setting c3 **[Power off delay]** > **[Standby timer]**.

✔ Measuring white balance

Preset manual white balance cannot be measured during multiple exposures.

Image quality

Choose a file format for photographs.

Option	Description
[RAW + JPEG fine]	<ul style="list-style-type: none">Record two copies of each photo: a RAW image and a JPEG copy.Only the JPEG copy is displayed during playback. The RAW copies can only be viewed using a computer.Deleting the JPEG copies on the camera also deletes the RAW images.
[RAW + JPEG normal]	
[RAW + JPEG basic]	
[RAW]	RAW images have the highest quality, and the quality decreases from “fine”, to “normal”, and to “basic”.
[JPEG fine]	
[JPEG normal]	
[JPEG basic]	

The option currently selected is shown in the display during shooting.



✓ RAW

- RAW files have the extension “*.nef”.
- The process of converting RAW files to JPEG and other widely-supported formats is referred to as “RAW processing”. A variety of settings can be adjusted during this process, including exposure compensation, white balance, and Picture Controls.
- RAW processing has no effect on the original RAW data, meaning that it can be repeated as often and using as many different combinations of settings as desired while maintaining image quality.
- RAW processing can be performed in-camera using the [RAW processing] item in the retouch menu or on a computer using Nikon’s NX Studio software. NX Studio is available free-of-charge from the Nikon Download Center.

✓ “RAW + JPEG”

- The camera displays only the JPEG copies of photos recorded at image quality settings of “RAW + JPEG”. The RAW copies can only be viewed using a computer.
 - Deleting the JPEG copies on the camera also deletes the RAW images.
-

Image size

Choose the size at which photographs are recorded. The option currently selected is shown in the display during shooting.



Image size versus number of pixels

The physical dimensions of the photos in pixels vary with the option selected for [Choose image area] in the photo shooting menu.

Image area	Image size		
	Large	Medium	Small
[DX (24×16)]	5568×3712	4176×2784	2784×1856
[1:1 (16×16)]	3712×3712	2784×2784	1856×1856
[16:9 (24×14)]	5568×3128	4176×2344	2784×1560

Flash mode

Choose a flash mode for optional flash units. The options available vary with the shooting mode.





Option		Available in
	[Fill flash]	AUTO, P, S, A, M
	[Red-eye reduction]	AUTO, P, S, A, M
	[Slow sync]	P, A
	[Slow sync + red-eye]	P, A
	[Rear-curtain sync]	P, S, A, M
	[Flash off]	AUTO, P, S, A, M

The option currently selected is shown in the display during shooting.



Metering

Metering determines how the camera sets exposure.

Option	Description
 [Matrix metering]	The camera meters a wide area of the frame and sets exposure according to tone distribution, color, composition, and distance for results close to those seen by the naked eye.
 [Center-weighted metering]	<ul style="list-style-type: none"> • The camera assigns the greatest weight to the center of the frame. It can be used with subjects that dominate the composition, for example. • Center-weighted metering is also recommended when using filters with an exposure factor (filter factor) over 1x. • The size of the area assigned the greatest weight can be selected using Custom Setting b2 [Center-weighted area].
 [Spot metering]	<ul style="list-style-type: none"> • The camera meters a circle with a diameter of 3.5 mm/0.14 in. (equivalent to approximately 2.5% of the frame). This ensures that the subject will be correctly exposed even when the background is much brighter or darker. • The metered area is centered on the current focus point. If AF-area mode (□□102) is set to [Auto-area AF], [Auto-area AF (people)], or [Auto-area AF (animals)], the camera will instead meter the center focus point.
 [Highlight-weighted metering]	The camera assigns the greatest weight to highlights. Use this option to reduce loss of detail in highlights, for example when photographing spotlight performers on stage.

The option currently selected is shown in the display during shooting.



Wi-Fi connection

Enable or disable Wi-Fi.

- Enable Wi-Fi to establish wireless connections to computers or between the camera and smartphones or tablets (smart devices) running the SnapBridge app (☐483).
- The camera displays a Wi-Fi icon when Wi-Fi is enabled.



- To turn Wi-Fi off, highlight [**Wi-Fi connection**] in the **i** menu and press **OK**; if Wi-Fi is currently enabled, a [**Close Wi-Fi connection**] prompt will be displayed. Press **OK** to end the connection.

Active D-Lighting

Preserve details in highlights and shadows, creating pictures with natural contrast. Use for high-contrast scenes, for example when photographing brightly-lit outdoor scenery through a door or window

or taking pictures of shaded subjects on a sunny day. Active D-Lighting is most effective when used with matrix metering.



[Off]



[Auto]

Option		Description
☞A	[Auto]	The camera automatically adjusts Active D-Lighting in response to shooting conditions.
☞H*	[Extra high]	Choose the amount of Active D-Lighting performed from [Extra high], [High], [Normal], and [Low].
☞H	[High]	
☞N	[Normal]	
☞L	[Low]	
☞OFF	[Off]	Active D-Lighting off.

The option currently selected is shown in the display during shooting.

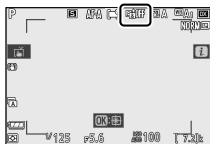

✔ Active D-Lighting

- “Noise” in the form of randomly-spaced bright pixels, fog, or lines may appear in photos taken with Active D-Lighting.
- In mode **M**, [A Auto] is equivalent to [N Normal].
- Uneven shading may be visible with some subjects.
- This function does not apply at high ISO sensitivities (Hi 1, Hi 2), including high sensitivities selected via auto ISO sensitivity control.

Release mode

Choose the operation performed when the shutter is released.

	Option	Description
S	[Single frame]	The camera takes one photograph each time the shutter-release button is pressed.
L	[Continuous L]	<ul style="list-style-type: none">• The camera takes photographs at a selected rate while the shutter-release button is pressed.• The frame advance rate can be chosen by rotating the sub-command dial when continuous L is selected in the release-mode menu.• Choose from rates of from 1 to 4 fps.
H	[Continuous H]	The camera takes photos at up to 5 fps while the shutter-release button is pressed.
H ⁺	[Continuous H (extended)]	<ul style="list-style-type: none">• The camera takes photos at up to 11 fps while the shutter-release button is pressed.• Optional flash units will not fire.• Flicker reduction does not take effect.
T	[Self-timer]	Take pictures with the self-timer (□169).

- Pressing  when [**Continuous L**] is highlighted displays frame advance rate options.



- The option currently selected is shown in the display during shooting.



✔ The shooting display

In continuous low-speed and continuous high-speed modes, the display is updated in real time even while shooting is in progress.

✔ Frame advance rate

Frame advance rate varies with camera settings.

Release mode	Image quality	RAW bit depth	Silent photography	
			Off	On
[Continuous L]	JPEG	—	User-selected frame advance rate	
	RAW	12 bit		
		14 bit		
[Continuous H]	JPEG	—	Approx. 5 fps	Approx. 4.5 fps
	RAW	12 bit		
		14 bit		Approx. 4 fps
[Continuous H (extended)]	JPEG	—	Approx. 11 fps*	Approx. 11 fps
	RAW	12 bit		
		14 bit	Approx. 9 fps	Approx. 8.5 fps

* Approx. 10 fps if [Electronic front-curtain shutter] is selected for Custom Setting d4 [Shutter type].

✔ Burst photography

- Depending on shooting conditions and memory card performance, the memory card access lamp may light for anywhere from a few tens of seconds to around a minute. Do not remove the memory card while the memory card access lamp is lit. Not only could any unrecorded images be lost, but the camera or memory card could be damaged.
- If the camera is switched off while the memory card access lamp is lit, it will not power off until all images in the buffer have been recorded.

- If the battery is exhausted while images remain in the buffer, the shutter release will be disabled and the images transferred to the memory card.

✔ Continuous H (extended)

Depending on the camera settings, continuous photography may result in apparent variations in exposure. If you notice changes in exposure, perform exposure lock (☐142) to lock the exposure during burst photography.

✔ The memory buffer

- While the shutter-release button is pressed halfway, the frame-count display will show the number of pictures that can be stored in the memory buffer.



- When the buffer is full, the display will show **r00** and the frame rate will drop.
- The number shown is approximate. The actual number of photos that can be stored in the memory buffer varies with camera settings and shooting conditions.

■ ■ The self-timer

In self-timer mode, pressing the shutter-release button starts a timer, and a photo is taken when the timer expires.

-
- 1** In [Release mode] in the **t** menu, highlight [Self-timer] and press .

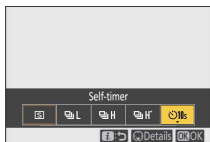

-
- 2** Choose the desired shutter-release delay and number of shots.

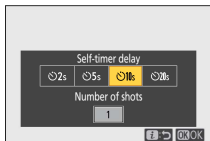

Press  to select the highlighted option.

-
- 3** Frame the photograph and focus.



The timer will not start if the shutter cannot be released, as may be the case, for example, if the camera is unable to focus when **AF-S** is selected for focus mode.

4 Start the timer.

- A  icon appears in the shooting display when the self-timer is enabled.
- Press the shutter-release button all the way down to start the timer; the self-timer lamp will begin to flash. The lamp stops flashing two seconds before the timer expires.





Taking multiple shots

The number of shots taken and the interval between shots can be selected using Custom Setting c2 [**Self-timer**].

Vibration reduction

Choose whether to enable vibration reduction. The options available vary with the lens.

	Option	Description
	[On]	Choose for enhanced vibration reduction when photographing static subjects.
	[Normal]	
	[Sport]	Choose when photographing athletes and other subjects that are moving rapidly and unpredictably.
	[Off]	Vibration reduction is disabled.

An icon appears in the display when a setting other than **[Off]** is selected.

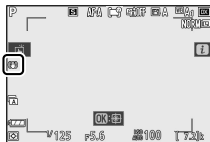









✔ Using vibration reduction: Notes



- Vibration reduction may be unavailable with some lenses.
- We recommend that you wait for the image in the display to stabilize before shooting.
- Depending on the lens, when vibration reduction is active, the image in the viewfinder may jiggle after the shutter is released, but this does not indicate a malfunction.
- **[Normal]** or **[Sport]** is recommended for panning shots. In **[Normal]** or **[Sport]** mode, vibration reduction applies only to motion that is not part of the pan. If the camera is panned horizontally, for example, vibration reduction will be applied only to vertical shake.
- If you will use a tripod or monopod with a VR lens camera, the settings may differ depending on the lens. Consult the lens documentation before use for more information.

AF-area mode

AF-area mode controls how the camera selects the focus-point for autofocus. For more information, see “AF-area mode” in the “Focus” section of “Basic settings” (□102).

Option		Option	
	[Pinpoint AF]		[Wide-area AF (S)]
	[Single-point AF]		[Wide-area AF (L)]
	[Dynamic-area AF]		[Wide-area AF (L-people)]

Option	
	[Wide-area AF (L-animals)]
	[Auto-area AF]

Option	
	[Auto-area AF (people)]
	[Auto-area AF (animals)]

The option currently selected is shown in the display during shooting.



Focus mode

Focus mode controls how the camera focuses. For more information, see “Focus mode” in the “Focus” section of “Basic settings” (□100).

Option	
AF-A	[AF mode auto-switch]
AF-S	[Single AF]

Option	
AF-C	[Continuous AF]
MF	[Manual focus]

The option currently selected is shown in the display during shooting.



Videos

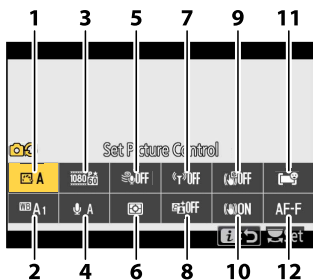

1 Set Picture Control (☞175)

2 White balance (☞175)

3 Frame size and rate/Video quality (☞175)

4 Microphone sensitivity (☞178)

5 Wind noise reduction (☞179)

6 Metering (☞180)

7 Wi-Fi connection (☞180)

8 Active D-Lighting (☞181)

9 Electronic VR (☞181)

10 Vibration reduction (☞182)

11 AF-area mode (☞182)

12 Focus mode (☞182)

✔ [Same as photo settings]

If **[Same as photo settings]** is selected for **[Set Picture Control]**, **[White balance]**, **[Active D-Lighting]**, or **[Vibration reduction]** in the video recording menu, a  icon will appear at the top left corner of the **i** menu. Changes made to the setting from the **i** menu in photo mode will also apply in video mode and *vice-versa*.



Set Picture Control

Choose a Picture Control for video recording. For more information, see “Still images” (□147).

White balance

Adjust white balance for video recording. For more information, see “Still images” (□153).

Frame size and rate/Video quality







Select the video frame size (in pixels), frame rate, and video quality.







■ Video quality

Choose from [**High quality**] and [**Normal**]. A star (“★”) appears in the icon for [**Frame size/frame rate**] when [**High quality**] is selected. Some frame size/rate options only support [**High quality**].

■ Frame size/frame rate

The maximum bit rate and recording time for each [**Frame size/frame rate**] option are shown below. The bit rate varies with the option selected for video quality.

Option ¹	Max. bit rate		Max. recording time
	High quality	Normal	
 [3840×2160; 30p] ²	144 Mbps	— ³	29 min. 59 s ⁵
 [3840×2160; 25p] ²			
 [3840×2160; 24p] ²			
 [1920×1080; 120p] ⁴			
 [1920×1080; 100p] ⁴			
 [1920×1080; 60p]	56 Mbps	28 Mbps	

Option1		Max. bit rate		Max. recording time
		High quality	Normal	
 [1920×1080; 50p]	56 Mbps	28 Mbps	29 min. 59 s ⁵	
 [1920×1080; 30p]	28 Mbps	14 Mbps		
 [1920×1080; 25p]				
 [1920×1080; 24p]				
 [1920×1080; 30p ×4 (slow-motion)] ⁴	36 Mbps	—3	3 min.	
 [1920×1080; 25p ×4 (slow-motion)] ⁴				
 [1920×1080; 24p ×5 (slow-motion)] ⁴				29 Mbps

- The frame rates for 120p, 100p, 60p, 50p, 30p, 25p, and 24p are respectively 119.88 fps, 100 fps, 59.94 fps, 50 fps, 29.97 fps, 25 fps, and 23.976 fps.
- Videos are recorded in 4K UHD.
- Video quality fixed at **[High quality]**.
- The following features cannot be used.
 - Detection of human, dog, or cat faces or eyes when **[Wide-area AF (L-people)]**, **[Wide-area AF (L-animals)]**, **[Auto-area AF (people)]**, or **[Auto-area AF (animals)]** is selected for **[AF-area mode]**.
 - Flicker reduction
 - Electronic VR
 - HDMI output while recording videos
- If you use a memory card that has a capacity over 32 GB, you can record up to the maximum length with one video recording. For memory cards 32 GB or less, you can record up to the maximum length, but the video may be divided between up to 8 files. Each divided file may be up to 4 GB in size. The number of files and the length of each file vary with the options selected for **[Frame size/frame rate]** and **[Video quality]**.

The option currently selected for [**Frame size/frame rate**] is shown in the display during shooting.

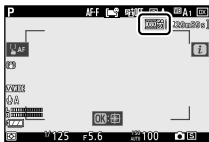

■ ■ Slow motion videos

You can record slow motion videos by selecting [**1920×1080; 30p ×4 (slow-motion)**], [**1920×1080; 25p ×4 (slow-motion)**], or [**1920×1080; 24p ×5 (slow-motion)**] for [**Frame size/frame rate**]. Sound is not recorded.

- In [**1920×1080; 30p ×4 (slow-motion)**] for example, images read at a frame rate of 120p are recorded as a video in 30p. A video recorded for about 10 seconds will be played back for about 40 seconds. You can see momentary actions in slow motion, such as the impact of a ball in sports.



- The frame rates when reading images and when recording and playing back videos are as follows.

Frame size/frame rate	Frame rate when reading images*	Frame rate when recording and playing back videos*
1920×1080; 30p ×4 (slow-motion)	120p	30p

Frame size/frame rate	Frame rate when reading images*	Frame rate when recording and playing back videos*
1920×1080; 25p ×4 (slow-motion)	100p	25p
1920×1080; 24p ×5 (slow-motion)	120p	24p

* 120p: 119.88 fps, 100p: 100 fps, 30p: 29.97 fps, 25p: 25 fps, 24p: 23.976 fps



✔ When recording slow motion videos

The following features cannot be used when recording slow motion videos.

- Flicker reduction
- Electronic VR
- Recording timecodes
- HDMI output while recording videos

Microphone sensitivity

Turn built-in or external microphones on or off or adjust microphone sensitivity.

Option	Description
 A	Adjust microphone sensitivity automatically.
[Microphone off]	Turn sound recording off.
 1–  20	Adjust microphone sensitivity manually. Choose from values of from [1] to [20]. The higher the value, the higher the sensitivity; the lower the value, the lower the sensitivity.

- At settings other than **🔇**, the option currently selected is shown in the display.



- If the sound level is displayed in red, the volume is too high. Reduce microphone sensitivity.



✔ Videos without sound

Videos recorded with **[Microphone off]** selected for microphone sensitivity are indicated by a **🔇** icon.



Wind noise reduction

Choose whether to use wind noise reduction when recording videos.

Option	Description
[On]	Enables the low-cut filter, reducing noise produced by wind blowing over the built-in microphone. Note that other sounds may also be affected.
[Off]	Disables wind noise reduction.

An icon appears in the display when **[On]** is selected.



Selecting **[On]** for **[Wind noise reduction]** has no effect on optional stereo microphones. Wind-noise reduction for optional stereo microphones that support this feature can be enabled or disabled using microphone controls.

Metering

Choose how the camera sets exposure during video recording. For more information, see “Still images” (□162).

✓ Metering

[Spot metering] is not available in video mode.

Wi-Fi connection

Enable or disable Wi-Fi. For more information, see “Still images” (□164) or see “Wi-Fi connection” in the “Connect to smart device” section of the “Menu guide” (□409).

Active D-Lighting

Preserve details in highlights and shadows, creating videos with natural contrast. Select [**Same as photo settings**] to use the option currently selected for photos. For more information about Active D-Lighting, see “Still images” (□164).

✔ [**Same as photo settings**]

Note that if [**Same as photo settings**] is selected for Active D-Lighting in the video recording menu and [**Auto**] is selected in the photo shooting menu, videos will be shot at a setting equivalent to [**Normal**].

Electronic VR

Choose whether to enable electronic vibration reduction in video mode.

Option	Description
[On]	<ul style="list-style-type: none">• Enable electronic vibration reduction during video recording.• If the video frame size and rate is set to 1920×1080 120p, 1920×1080 100p, or 1920×1080 slow-motion, electronic vibration reduction is disabled.• Note that when [On] is selected, the angle of view will be reduced, slightly increasing the apparent focal length.
[Off]	Electronic vibration reduction is disabled.

An icon appears in the display when [**On**] is selected.









Vibration reduction

Choose whether to enable vibration reduction in video mode. For more information, see “Still images” (□171).

AF-area mode

AF-area mode controls how the camera selects the focus-point for autofocus. For more information, see “AF-area mode” in the “Focus” section of “Basic settings” (□102).

Option		Option	
[*]	[Single-point AF]		[Wide-area AF (L-animals)]
	[Wide-area AF (S)]		[Auto-area AF]
	[Wide-area AF (L)]		[Auto-area AF (people)]
	[Wide-area AF (L-people)]		[Auto-area AF (animals)]

Focus mode

Focus mode controls how the camera focuses. For more information, see “Focus mode” in the “Focus” section of “Basic settings” (□100).

Option		Option	
AF-S	[Single AF]	AF-F	[Full-time AF]
AF-C	[Continuous AF]	MF	[Manual focus]





Playback

Viewing pictures

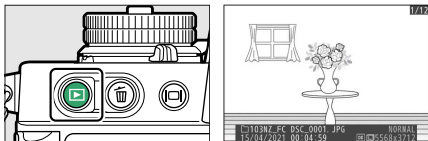
Full-frame playback

Press the  button to view the most recent picture full frame in the display.







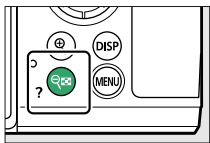

- Press  to return to the previous frame,  to skip to the next frame.
- Press  or , or the **DISP** button to view more information on the current picture (186).

Thumbnail playback

To view multiple pictures, press the  (?) button when a picture is displayed full frame.









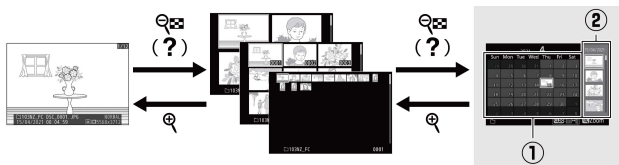

- The number of pictures displayed increases from 4 to 9 to 72 each time the  (?) button is pressed, and decreases with each press of the  button.
- Highlight pictures using , , , or .



Calendar playback

To view images taken on a selected date, press the  (?) button when 72 images are displayed.



- Use the multi selector (, , , or ) to highlight a date in the date list (1) and press  (?) to place the cursor in the thumbnail list (2).

Press  or  to highlight pictures in the thumbnail list. To return to the date list, press the  (?) button a second time.

- To zoom in on the picture highlighted in the thumbnail list, press and hold the  button.
- To exit to thumbnail playback, press  when the cursor is in the date list.

✔ Touch controls

Touch controls can be used when pictures are displayed in the monitor (56).

✔ Rotate tall

To display “tall” (portrait-orientation) photographs in tall orientation, select **[On]** for **[Rotate tall]** in the playback menu.





✔ Picture review

When **[On]** is selected for **[Picture review]** in the playback menu, photographs are automatically displayed after shooting; there is no need for you to press the  button.



- If **[On (monitor only)]** is selected, photos will not be displayed in the viewfinder.
 - In continuous release modes, display begins when shooting ends, with the first photograph in the current series displayed.
 - Images are not rotated automatically during picture review even when **[On]** is selected for **[Rotate tall]** in the playback menu.
-

Photo information

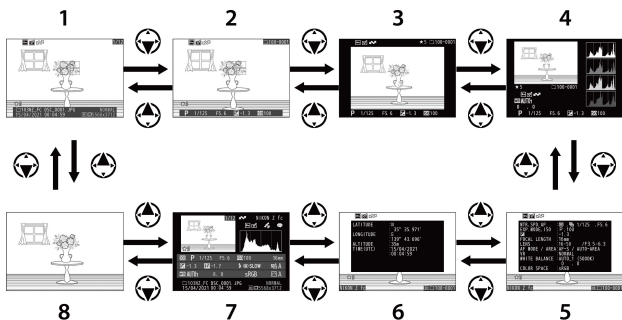
Photo information is superimposed on images displayed in full-frame playback. Press , , or the **DISP** button to cycle through photo information as shown below.



- | | | | |
|---|--------------------------------|---|----------------------------------|
| 1 | File information | 5 | Shooting data ^{1,2} |
| 2 | Exposure data ¹ | 6 | Location data ³ |
| 3 | Highlight display ¹ | 7 | Overview data ¹ |
| 4 | RGB histogram ¹ | 8 | None (picture only) ¹ |

- 1 Displayed only if the corresponding option is selected for **[Playback display options]** in the playback menu.
- 2 The shooting data list has multiple pages, which can be viewed by pressing  or .
- 3 Location data are displayed only if embedded in the picture at the time it was taken.

File information

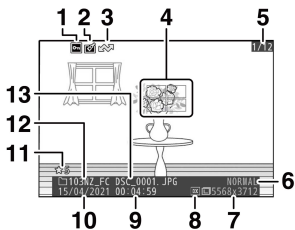

1	Protect status (☐125)
2	Retouch indicator (☐424)
3	Upload marking (☐202)
4	Focus point* (☐85)
5	Frame number/total number of frames
6	Image quality (☐160)
7	Image size (☐161)

8	Image area (☐243)
9	Time of recording (☐393)
10	Date of recording (☐393)
11	Rating (☐123)
12	Folder name (☐238)
13	File name (☐242)

- * Displayed only if **[Focus point]** is selected for **[Playback display options]** in the playback menu.

Exposure data

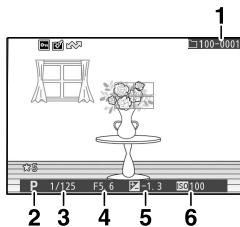

1 Folder number–frame number
(□□238)

2 Shooting mode (□□127)

3 Shutter speed (□□128, □□131)

4 Aperture (□□130, □□131)

5 Exposure compensation value
(□□139)

6 ISO sensitivity* (□□137)

* Displayed in red if the picture was taken in mode **P**, **S**, **A**, or **M** with auto ISO sensitivity control enabled.

Highlight display

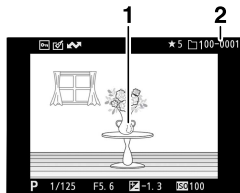

1 Highlights (areas that may be
overexposed)

2 Folder number–frame number
(□□238)

RGB histogram

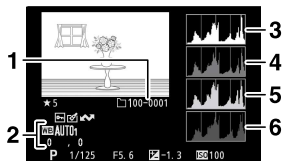

- 1 Folder number–frame number
(□□238)
- 2 White balance (□□116, □□153,
□□248)
Color temperature (□□155)
Preset manual (□□156)
White balance fine-tuning
(□□154)

- 3 Histogram (RGB channel)
- 4 Histogram (red channel)
- 5 Histogram (green channel)
- 6 Histogram (blue channel)

✔ Playback zoom

To zoom in on the picture in the histogram display, press \mathcal{Q} . The histogram will be updated to show only the data for the portion of the image visible in the display. Use the multi selector to scroll to areas of the frame not visible in the monitor. Press \mathcal{Q} (?) to zoom out.

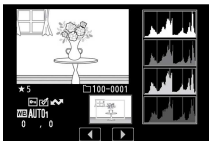

✔ Histograms

Histograms show tone distribution. Pixel brightness (tone) is plotted on the horizontal axis and the number of pixels on the vertical axis.

- If the image contains objects with a wide range of brightnesses, the distribution of tones will be relatively even.



- If the image is dark, the distribution will be shifted to the left.



- If the image is bright, the distribution will be shifted to the right.





Increasing exposure compensation shifts the distribution of tones to the right, while decreasing exposure compensation shifts the distribution to the

left. Histograms can provide a rough idea of overall exposure when bright ambient lighting makes it difficult to see pictures in the monitor.

✔ **The histogram display**

- RGB histograms show tone distribution.
 - Camera histograms may differ from those displayed in imaging applications. Use them as a guide to actual tone distribution.
-

Shooting data

View the settings in effect at the time the picture was taken. The shooting data list has multiple pages, which can be viewed by pressing  or .

Basic shooting data

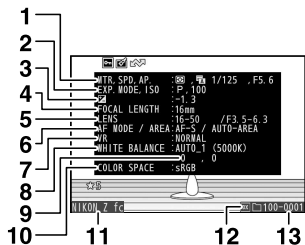

1	Metering (☐162) Shutter type (☐357) Shutter speed (☐128, ☐131) Aperture (☐130, ☐131)	6	Focus mode (☐100) AF-area mode (☐102)
2	Shooting mode (☐127) ISO sensitivity ¹ (☐137)	7	Vibration reduction (☐171)
3	Exposure compensation value (☐139) Optimal exposure tuning ² (☐353)	8	White balance ³ (☐116, ☐153, ☐248)
4	Focal lengths	9	White balance fine-tuning (☐154)
5	Lens data	10	Color space (☐262)
		11	Camera name
		12	Image area (☐243)
		13	Folder number-frame number (☐238)

- 1 Displayed in red if the picture was taken in mode **P**, **S**, **A**, or **M** with auto ISO sensitivity control enabled.
- 2 Displayed if Custom Setting b3 [**Fine-tune optimal exposure**] has been set to a value other than zero for any metering method.

- 3 Also includes the color temperature for pictures taken using **WB A [Auto]**.

Flash data

Flash data are displayed only for pictures taken with optional flash units (□497, □508).



1 Flash type

2 Remote flash control

3 Flash mode (□502)

4 Flash control mode (□501)

Flash compensation (□504)

Picture Control data

The items displayed vary with the Picture Control in effect when the picture was taken.



1 Picture Control (□147, □255)

Other shooting data



- 1 High ISO noise reduction (□□263)
Long exposure noise reduction (□□262)
- 2 Active D-Lighting (□□164)
- 3 HDR exposure differential (□□289)
HDR smoothing (□□289)

- 4 Vignette control (□□264)
- 5 Retouch history (□□424)
Changes are listed in the order applied.
- 6 Image comment (□□404)

Copyright information

Copyright information is only displayed if recorded using the **[Copyright information]** item in the setup menu at the time the picture was taken.



- 1 Photographer (□□405)

- 2 Copyright holder (□□405)

Location data

The location data page lists the latitude, longitude, and other location data downloaded from smartphones or tablets.

- The items listed vary with the device supplying the location data.
- The location data displayed with videos are those reported at the start of recording.

Overview

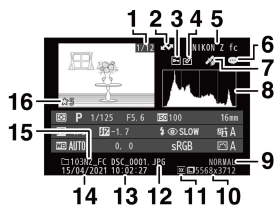

- 1 Frame number/total number of frames
- 2 Upload marking (□202)
- 3 Protect status (□125)
- 4 Retouch indicator (□424)
- 5 Camera name
- 6 Image comment indicator (□404)
- 7 Location data indicator
- 8 Histogram (□190)

- 9 Image quality (□160)
- 10 Image size (□161)
- 11 Image area (□243)
- 12 File name (□242)
- 13 Time of recording (□393)
- 14 Date of recording (□393)
- 15 Folder name (□238)
- 16 Rating (□123)

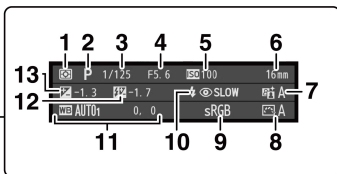
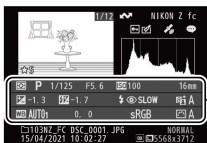

<p>1 Metering (☐162)</p> <p>2 Shooting mode (☐127)</p> <p>3 Shutter speed (☐128, ☐131)</p> <p>4 Aperture (☐130, ☐131)</p> <p>5 ISO sensitivity¹ (☐137)</p> <p>6 Focal lengths</p> <p>7 Active D-Lighting (☐164)</p> <p>8 Picture Control (☐147, ☐255)</p> <p>9 Color space (☐262)</p> <p>10 Flash mode² (☐502)</p>	<p>11 White balance (☐116, ☐153, ☐248)</p> <p>Color temperature (☐155)</p> <p>Preset manual (☐156)</p> <p>White balance fine-tuning (☐154)</p> <p>12 Flash compensation² (☐504)</p> <p>Commander mode²</p> <p>13 Exposure compensation value (☐139)</p>
--	---

- 1 Displayed in red if the picture was taken in mode **P**, **S**, **A**, or **M** with auto ISO sensitivity control enabled.
- 2 Flash data are displayed only for pictures taken with optional flash units (☐497, ☐508).

The **i** button (playback mode)

Pressing the **i** button during playback zoom or full-frame or thumbnail playback displays the **i** menu for playback mode. Highlight items and press **OK** or **▶** to select.

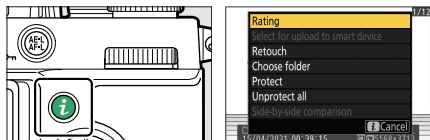



Press the **i** button again to return to playback.

- During calendar playback, the **i** menu can be viewed by pressing the **i** button when thumbnails are displayed.

Photos

Option	Description
[Quick crop] ¹	Save a copy of the current image cropped to the area visible in the display. This option is not available when RGB histograms are displayed (□189).
[Rating]	Rate the current picture (□123).
[Select for upload to smart device]	Select the current picture for upload (□202). The option displayed varies with the type of device connected.
[Select for upload to computer]	
[Retouch]	Create a retouched copy of the current picture (□424).

Option	Description
[Choose folder]	Select a folder. You can then highlight a folder and press  to view the pictures it contains.
[Protect]	Add protection to or remove protection from the current picture ( 125).
[Unprotect all] ²	Remove protection from all pictures in the folder currently selected for [Playback folder] in the playback menu.
[Side-by-side comparison] ³	Compare retouched copies to the originals.

- 1 Available only during playback zoom.
- 2 Not available during playback zoom.
- 3 Available only when a retouched copy (indicated by a  icon) or the source picture for a retouched copy is selected.

✔ [Side-by-side comparison]

Choose [**Side-by-side comparison**] to compare retouched copies with the unretouched originals.

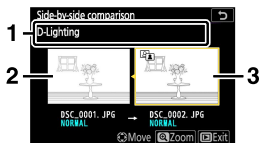

1 Options used to create copy

2 Source image

3 Retouched copy



- The source image is displayed on the left, the retouched copy on the right.
- The options used to create the copy listed at the top of the display.
- Press \leftarrow or \rightarrow to switch between the source image and the retouched copy.
- If the copy is an overlay created from multiple source images, press \leftarrow or \rightarrow to view the other images.
- If the source has been copied multiple times, press \uparrow or \downarrow to view the other copies.
- To view the highlighted picture zoomed in, press and hold the \times button.
- Press \odot to return to playback with the highlighted image displayed full-frame.
- To exit to playback, press the \square button.
- The source image will not be displayed if the copy was created from a photograph that is now protected.
- The source image will not be displayed if the copy was created from a photograph that has since been deleted.

Videos

Option	Description
[Rating]	Rate the current video (\square 123).

Option	Description
[Select for upload to computer]	Select the current video for upload (□□202).
[Volume control]	Adjust playback volume.
[Trim video]	Trim footage from the current video and save the edited copy in a new file (□□204).
[Choose folder]	Select a folder. You can then highlight a folder and press ⊞ to view the pictures it contains.
[Protect]	Add protection to or remove protection from the current picture (□□125).
[Unprotect all]	Remove protection from all pictures in the folder currently selected for [Playback folder] in the playback menu.

Videos (playback paused)

Option	Description
 [Choose start/end point]	Trim footage from the current video and save the edited copy in a new file (□□204).
 [Save current frame]	Save a selected frame as a JPEG still (□□207).

■ ■ Select for upload

Follow the steps below to select the current picture for upload to a smart device or computer.

- The **i** menu items used to select pictures for upload vary with the type of device connected:

- [**Select for upload to smart device**]: Displayed when the camera is connected to a smart device via built-in Bluetooth using [**Connect to smart device**] in the setup menu (☞408).
- [**Select for upload to computer**]: Displayed when the camera is connected to a computer via built-in Wi-Fi using [**Connect to computer**] in the setup menu (☞411).
- Videos cannot be selected for upload when the camera is connected to a smart device via the SnapBridge app.
- The maximum file size for videos uploaded by other means is 4 GB.

1 Select the desired picture and press the **i** button.

2 Highlight [**Select for upload to smart device**] or [**Select for upload to computer**] and press **OK**.

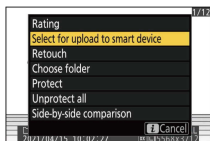

The picture will be marked with a  icon.



✓ Removing upload marking

To remove upload marking, repeat Steps 1 and 2.

■ Choose start/end point

Trim footage from the current video and save the edited copy in a new file.

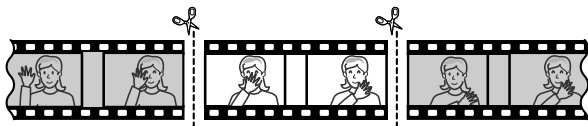

1 Display a video full frame.

2 Pause the video on the new opening frame.

- Press the **OK** button to start playback videos. Press **⏸** to pause.
- Your approximate position in the video can be ascertained from the video progress bar.

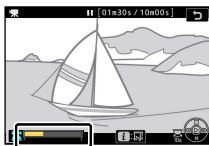

- Press **⏪** or **⏩** or rotate the main command dial to locate the desired frame.

3 Select [Choose start/end point].

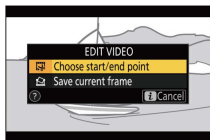

Press the **i** button, highlight [**Choose start/end point**], and press **OK**.

4 Choose the start point.

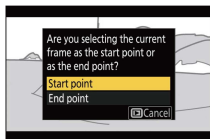

To create a copy that begins from the current frame, highlight **[Start point]** and press **OK**.

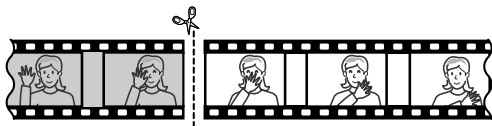

5 Confirm the new start point.



- If the desired frame is not currently displayed, press **⏪** or **⏩** to advance or rewind.
- Rotate the main command dial one stop to skip ahead or back 10 s.
- Rotate the sub-command dial to skip to the last or first frame.

6 Choose the end point.

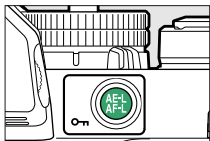

- Press the **AE-L/AF-L** (**On**) button to switch to the end-point selection tool (**▮**) and then select the closing frame (**▮**) as described in Step 5.

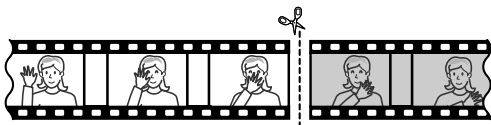

7 Press **Ⓢ** to create the copy.

8 Preview the copy.

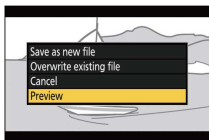

- To preview the copy, highlight [**Preview**] and press **OK** (to interrupt the preview and return to the save options menu, press **Ⓢ**).
- To abandon the current copy and return to Step 5, highlight [**Cancel**] and press **OK**.

9 Choose a save option.

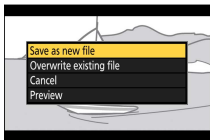

- Choose [**Save as new file**] and press the \odot button to save the edited copy as a new file.
- To replace the original video with the edited copy, highlight [**Overwrite existing file**], press \odot , and then highlight [**Yes**] and press \odot .

✔ Trimming videos

- The copy will not be saved if there is insufficient space available on the memory card.
- Videos less than two seconds long cannot be edited using [**Choose start/end point**].
- Copies have the same time and date of creation as the original.

✔ Removing opening or closing footage

- To remove only the closing footage from a video, choose [**End point**] in Step 4, press the \odot button, and proceed to Step 7 without pressing the $\overline{\text{AF-L}}$ (On) button in Step 6.
- To remove only the opening footage, proceed to Step 7 without pressing the $\overline{\text{AF-L}}$ (On) button in Step 6.

✔ The [Trim video] option (retouch menu)



Videos can also be edited using the [Trim video] item in the retouch menu.

■■ Save current frame

Save a selected frame as a JPEG still.



1 Pause the video on the desired frame.

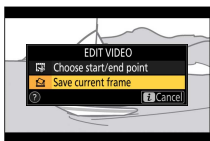

- Press  to pause playback.
- Press  or  to locate the desired frame.

2 Choose [Save current frame].





Press the  button, then highlight [**Save current frame**] and press  to create a JPEG copy of the current frame.

✓ [Save current frame]



- Stills are saved at the dimensions selected for [**Frame size/frame rate**] in the video recording menu when the video was recorded.
 - They cannot be retouched.
 - Some categories of photo information are not displayed during playback.
-

Playback zoom

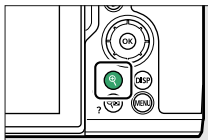
Press  or  to zoom in on photos displayed in full-frame playback. [DX (24×16)]-format images can be zoomed in to a maximum of approximately 21× for **Large**, 16× for **Medium**, or 10× for **Small**.



Using playback zoom

To	Description
Zoom in/ zoom out	<ul style="list-style-type: none">• Press the  button or use stretch gestures to zoom in.• To zoom out, press  (?) or use pinch gestures.  <p>A navigation window is displayed during the zoom ratio is altered, with the area currently visible indicated by a yellow border. A bar below the navigation window shows the zoom ratio, turning green at 1:1. The navigation window clears from the display after a few seconds.</p>
View other areas of image	Use the multi selector or glide gestures to view areas of image not visible in the monitor. Keep the multi selector pressed to scroll rapidly to other areas of frame.

To	Description
<p>Select faces</p>	<p>Faces detected during zoom are indicated by white borders in the navigation window. Rotate the sub-command dial or tap the on-screen guide to view other faces.</p> 
<p>View other pictures</p>	<p>Rotate the main command dial to view the same location in other photos without changing the zoom ratio (selecting a video cancels zoom). You can also view other photos by tapping the ◀ or ▶ icon at the bottom of the display.</p>
<p>Exit to shooting mode</p>	<p>Press the shutter-release button halfway or press the [] button to exit.</p>
<p>View menus</p>	<p>Press the MENU button to view the menus.</p>

Deleting pictures

Follow the steps below to delete pictures from memory cards. Note that pictures cannot be recovered once deleted. Pictures that are protected, however, cannot be deleted.

Using the delete button

Press the  button to delete the current picture.

- 1 Select the desired picture with the multi selector and press the  button.**

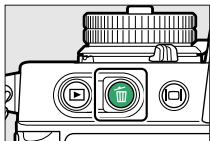

- A confirmation dialog will be displayed.
- To exit without deleting the picture, press .

- 2 Press the  button again.**

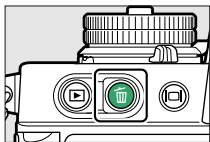



The picture will be deleted.

Calendar playback

During calendar playback, you can delete all photographs taken on a selected date by highlighting the date in the date list and pressing the  button.



Deleting multiple pictures

Use **[Delete]** in the playback menu to delete multiple pictures at once. Note that depending on the number of images, some time may be required for deletion.

Option		Description
	[Selected pictures]	Delete selected pictures.
	[Pictures shot on selected dates]	Delete all pictures taken on selected dates (□□213).
ALL	[All pictures]	Delete all pictures in the folder currently selected for [Playback folder] in the playback menu.

Deleting selected pictures

1 Select pictures.

- Highlight pictures using the multi selector and press the  (?) button to select; selected pictures are marked with  icons. Selected pictures can be deselected by pressing the  (?) button again.

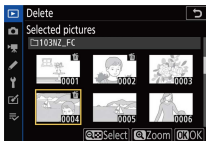
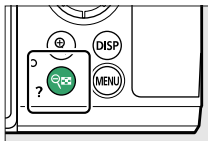

- Repeat until all the desired pictures are selected.
- To view the highlighted picture zoomed in, press and hold the  button.

2 Delete the pictures.



- Press **OK**; a confirmation dialog will be displayed.
- Highlight **[Yes]** and press **OK** to delete the selected pictures.

1 Pictures shot on selected dates

1 Select dates.

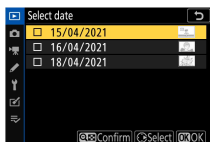

- Highlight dates using the multi selector and press **Enter** to select; selected dates are marked with icons. Selected dates can be deselected by pressing **Enter** again.
- Repeat until you have selected all the desired dates.

2 Delete the pictures.



- Press **OK**; a confirmation dialog will be displayed.
- Highlight [**Yes**] and press **OK** to delete all the pictures taken on the selected dates.

Menu guide

Defaults

The defaults for the playback, photo shooting, video recording, Custom Settings, and setup menus are listed below.

Playback menu defaults

Playback menu option	Default
[Delete]	—
[Playback folder]	All
[Playback display options]	
[Focus point]	<input type="checkbox"/>
[Exposure info]	<input type="checkbox"/>
[Highlights]	<input type="checkbox"/>
[RGB histogram]	<input type="checkbox"/>
[Shooting data]	<input type="checkbox"/>
[Overview]	<input type="checkbox"/>
[None (picture only)]	<input type="checkbox"/>
[Picture review]	Off
[Rotate tall]	On
[Slide show]	
[Picture type]	Photos and videos
[Frame interval]	2 s

Playback menu option	Default
[Rating]	—

Photo shooting menu defaults



Photo shooting menu option	Default
[Reset photo shooting menu]	—
[Storage folder]	
[Rename]	NZ_FC
[Select folder by number]	100
[Select folder from list]	—
[File naming]	DSC
[Choose image area]	DX (24×16)
[Image quality]	JPEG normal
[Image size]	Large
[RAW recording]	14-bit
[ISO sensitivity settings]	
[ISO sensitivity]	—
[Auto ISO sensitivity control]	Off
[Maximum sensitivity]	51200
[Maximum sensitivity with 	Same as without flash
[Minimum shutter speed]	Auto
[White balance]	 A1: Keep overall atmosphere
Fine-tune	A-B: 0, G-M: 0

Photo shooting menu option	Default
[Choose color temperature]	5000 K
[Preset manual]	d-1
[Set Picture Control]	Auto
[Manage Picture Control]	—
[Color space]	sRGB
[Active D-Lighting]	Off
[Long exposure NR]	Off
[High ISO NR]	Normal
[Vignette control]	Normal
[Diffraction compensation]	On
[Auto distortion control]	On
[Flicker reduction shooting]	Off
[Metering]	Matrix metering
[Flash control]	
[Flash control mode]	TTL
[Wireless flash options]	Off
[Flash mode]	Fill flash
[Flash compensation]	0.0
[Release mode]	Single frame
[Focus mode]	AF mode auto-switch
[AF-area mode]	Auto-area AF (people)
[Vibration reduction]	(Varies with lens)

Photo shooting menu option	Default
[Auto bracketing]	
[Auto bracketing set]	AE & flash bracketing
[Number of shots]	0
[Increment]	1.0
[Multiple exposure]	
[Multiple exposure mode]	Off
[Number of shots]	2
[Overlay mode]	Average
[Save individual pictures (RAW)]	On
[Overlay shooting]	On
[Select first exposure (RAW)]	—
[HDR (high dynamic range)]	
[HDR mode]	Off
[Exposure differential]	Auto
[Smoothing]	Normal
[Save individual pictures (RAW)]	Off
[Interval timer shooting]	
[Choose start day/time]	Now
[Interval]	1 min.
[Intervals×shots/interval]	0001×1
[Exposure smoothing]	On
[Silent photography]	On

Photo shooting menu option		Default
[Interval priority]		Off
[Focus before each shot]		Off
[Options]		Off
[Starting storage folder]		
	[New folder]	<input type="checkbox"/>
	[Reset file numbering]	<input type="checkbox"/>

[Time-lapse video]

[Interval]	5 s
[Shooting time]	25 min.
[Exposure smoothing]	On
[Silent photography]	On
[Frame size/frame rate]	1920×1080; 60p
[Interval priority]	Off
[Focus before each shot]	Off

[Focus shift shooting]

[No. of shots]	100
[Focus step width]	5
[Interval until next shot]	0
[First-frame exposure lock]	On
[Silent photography]	On
[Starting storage folder]	
	[New folder] <input type="checkbox"/>

Photo shooting menu option	Default
[Reset file numbering]	<input type="checkbox"/>
[Silent photography]	Off

Video recording menu defaults

Video recording menu option	Default
[Reset video recording menu]	—
[File naming]	DSC
[Frame size/frame rate]	1920×1080; 60p
[Video quality]	High quality
[Video file type]	MOV
[ISO sensitivity settings]	
[Maximum sensitivity]	25600
[Auto ISO control (mode M)]	On
[ISO sensitivity (mode M)]	—
[White balance]	Same as photo settings
Fine-tune	A-B: 0, G-M: 0
[Choose color temperature]	5000 K
[Preset manual]	d-1
[Set Picture Control]	Same as photo settings
[Manage Picture Control]	—
[Active D-Lighting]	Off
[High ISO NR]	Normal

Video recording menu option	Default
[Vignette control]	Normal
[Diffraction compensation]	On
[Auto distortion control]	On
[Flicker reduction]	Auto
[Metering]	Matrix metering
[Release mode (save frame)]	Single frame
[Focus mode]	Full-time AF
[AF-area mode]	Auto-area AF (people)
[Vibration reduction]	Same as photo settings
[Electronic VR]	Off
[Microphone sensitivity]	Auto
[Attenuator]	Disable
[Frequency response]	Wide range
[Wind noise reduction]	Off
[Timecode]	
[Record timecodes]	Off
[Count-up method]	Record run
[Timecode origin]	—
[Drop frame]	On



Custom Settings menu defaults

Custom Settings menu option		Default
[Reset custom settings]		—
a1	[AF-C priority selection]	Release
a2	[AF-S priority selection]	Focus
a3	[Focus tracking with lock-on]	3
a4	[Focus points used]	All points
a5	[Store points by orientation]	No
a6	[AF activation]	Shutter/AF-ON
[Limit AF-area mode selection]		
a7	[Pinpoint AF]	<input checked="" type="checkbox"/>
	[Single-point AF]	✓(cannot be deselected)
	[Dynamic-area AF]	<input checked="" type="checkbox"/>
	[Wide-area AF (S)]	<input checked="" type="checkbox"/>
	[Wide-area AF (L)]	<input checked="" type="checkbox"/>
	[Wide-area AF (L-people)]	<input checked="" type="checkbox"/>
	[Wide-area AF (L-animals)]	<input checked="" type="checkbox"/>
	[Auto-area AF]	<input checked="" type="checkbox"/>
	[Auto-area AF (people)]	<input checked="" type="checkbox"/>
	[Auto-area AF (animals)]	<input checked="" type="checkbox"/>
a8	[Focus point wrap-around]	No wrap
[Focus point options]		
a9	[Manual focus mode]	On

Custom Settings menu option		Default
a9	[Dynamic-area AF assist]	On
a10	[Low-light AF]	On
a11	[Built-in AF-assist illuminator]	On
a12	[Manual focus ring in AF mode]	Enable
b1	[Easy exposure compensation]	On
b2	[Center-weighted area]	Φ 8 mm
[Fine-tune optimal exposure]		
b3	[Matrix metering]	0
	[Center-weighted metering]	0
	[Spot metering]	0
	[Highlight-weighted metering]	0
b4	[ mode exposure comp.]	Enable
c1	[Shutter-release button AE-L]	Off
[Self-timer]		
c2	[Self-timer delay]	10 s
	[Number of shots]	1
	[Interval between shots]	0.5 s
[Power off delay]		
c3	[Playback]	10 s
	[Menus]	1 min
	[Picture review]	4 s

Custom Settings menu option		Default
c3	[Standby timer]	30 s
d1	[CL mode shooting speed]	3 fps
d2	[Maximum shots per burst]	100
d3	[Exposure delay mode]	Off
d4	[Shutter type]	Auto
d5	[Extended shutter speeds (M)]	Off
d6	[File number sequence]	On
d7	[Apply settings to live view]	On
d8	[Framing grid display]	Off
	[Focus peaking]	
d9	[Peaking level]	Off
	[Peaking highlight color]	Red
d10	[View all in continuous mode]	On
e1	[Flash sync speed]	1/200 s
e2	[Flash shutter speed]	1/60 s
e3	[Exposure comp. for flash]	Entire frame
e4	[Auto  ISO sensitivity control]	Subject and background
e5	[Auto bracketing (mode M)]	Flash/speed
e6	[Bracketing order]	MTR > under > over

Custom Settings menu option		Default
f1	[Customize  menu]	Set Picture Control, White balance, Image quality, Image size, Flash mode, Metering, Wi-Fi connection, Active D-Lighting, Release mode, Vibration reduction, AF-area mode, Focus mode
[Custom controls (shooting)]		
f2	[Fn button]	White balance
	[AE-L/AF-L button]	AE/AF lock
	[OK button]	Select center focus point
	[Video record button]	Live view info display off
	[Lens Fn button]	AE/AF lock
	[Lens Fn2 button]	AF-ON
	[Lens control ring]	(Varies with lens)
[Custom controls (playback)]		
f3	[AE-L/AF-L button]	Protect
	[OK button]	Zoom on/off
[Customize command dials]		
f4	[Reverse rotation]	Exposure compensation: <input type="checkbox"/> , Shutter speed/aperture: <input type="checkbox"/>

Custom Settings menu option		Default
f4	[Change main/sub]	Exposure setting: Off, Autofocus setting: Off
	[Menus and playback]	Off
	[Sub-dial frame advance]	10 frames
f5	[Release button to use dial]	No
f6	[Reverse indicators]	
g1	[Customize  menu]	Set Picture Control, White balance, Frame size and rate/Video quality, Microphone sensitivity, Wind noise reduction, Metering, Wi-Fi connection, Active D-Lighting, Electronic VR, Vibration reduction, AF-area mode, Focus mode
[Custom controls]		
g2	[Fn button]	White balance
	[AE-L/AF-L button]	AE/AF lock
	[OK button]	Select center focus point
	[Shutter-release button]	Take photos
	[Lens Fn button]	AE/AF lock
	[Lens Fn2 button]	AF-ON

Custom Settings menu option		Default
g2	[Lens control ring]	(Varies with lens)
g3	[AF speed]	0
	[When to apply]	Always
g4	[AF tracking sensitivity]	4
g5	[Highlight display]	
	[Display pattern]	Off
	[Highlight display threshold]	248

Setup menu defaults

Setup menu option	Default
[Format memory card]	—
[Language]	(Default varies with country of purchase)
[Time zone and date]	
[Time zone]	(Default varies with country of purchase)
[Date and time]	—
[Date format]	(Default varies with country of purchase)
[Daylight saving time]	Off
[Monitor brightness]	0
[Monitor color balance]	A-B: 0, G-M: 0

Setup menu option	Default
[Viewfinder brightness]	Auto
[Viewfinder color balance]	A-B: 0, G-M: 0
[Limit monitor mode selection]	
[Automatic display switch]	<input checked="" type="checkbox"/>
[Viewfinder only]	<input checked="" type="checkbox"/>
[Monitor only]	<input checked="" type="checkbox"/>
[Prioritize viewfinder]	<input checked="" type="checkbox"/>
[Information display]	Dark on light
[AF fine-tuning options]	
[AF fine-tune]	Off
[Fine-tune and save lens]	—
[Default]	—
[List saved values]	—
[Non-CPU lens data]	
[Lens number]	1
[Focal length (mm)]	—
[Maximum aperture]	—
[Save focus position]	Off
[Image Dust Off ref photo]	—
[Pixel mapping]	—
[Image comment]	
[Attach comment]	<input type="checkbox"/>

Setup menu option	Default
[Copyright information]	
[Attach copyright information]	<input type="checkbox"/>
[Beep options]	
[Beep on/off]	Off
[Volume]	2
[Pitch]	Low
[Touch controls]	
[Enable/disable touch controls]	Enable
[Full-frame playback flicks]	Left→Right
[Self-portrait mode]	Enable
[HDMI]	
[Output resolution]	Auto
[Advanced]	
[Output range]	Auto
[External recording control]	Off
[Airplane mode]	Disable
[Connect to smart device]	
[Pairing (Bluetooth)]	
[Bluetooth connection]	Disable
[Select for upload (Bluetooth)]	
[Auto select for upload]	Off
[Wi-Fi connection]	—

Setup menu option	Default
[Upload while off]	On
[Location data (smart device)]	
[Latitude]	—
[Longitude]	—
[Altitude]	—
[UTC]	—
[Connect to computer]	
[Wi-Fi connection]	Disable
[Network settings]	—
[Options]	
[Auto upload]	Off
[Delete after upload]	No
[Upload file as]	RAW + JPEG
[Deselect all?]	—
[MAC address]	—
[Wireless remote (ML-L7) options]	
[Wireless remote connection]	Disable
[Save wireless remote controller]	—
[Delete wireless remote controller]	—
[Assign Fn1 button]	Same as camera  button
[Assign Fn2 button]	Same as camera MENU button
[Conformity marking]	—



Setup menu option	Default
[USB power delivery]	Enable
[Energy saving (photo mode)]	Enable
[Slot empty release lock]	Enable release
[Save/load menu settings]	—
[Reset all settings]	—
[Firmware version]	—

The playback menu: Managing images

To display the playback menu, select the  (playback menu) tab in the camera menu.



The playback menu contains the following items:

Item		Item	
[Delete]	232	[Rotate tall]	234
[Playback folder]	233	[Slide show]	234
[Playback display options]	233	[Rating]	236
[Picture review]	234		

See also

“Playback menu defaults” (215)

Delete

MENU button   playback menu

Delete multiple images. For more information, see “Deleting multiple pictures” (212).

Option	Description
 [Selected pictures]	Delete selected pictures.

Option		Description
	[Pictures shot on selected dates]	Delete all pictures taken on selected dates.
ALL	[All pictures]	Delete all pictures in the folder currently selected for [Playback folder] in the playback menu.

Playback folder

MENU button ➔  playback menu



Choose a folder for playback.

Option	Description
(Folder name)	Pictures in all folders with the selected name will be visible during playback. Folders can be renamed using the [Storage folder] > [Rename] option in the photo shooting menu.
[All]	Pictures in all folders will be visible during playback.
[Current]	Only pictures in the current folder will be visible during playback.

Playback display options

MENU button ➔  playback menu

Choose whether the focus points used when the photograph was taken are displayed during full-frame playback. You can also choose the types of photo information that can be viewed during full-frame playback.

- Highlight an option and press  to select () or deselect ()
- To complete the operation, press .

Picture review

MENU button ➔  playback menu

Choose whether pictures are automatically displayed in the monitor immediately after shooting.

Option	Description
[On]	Pictures appear in the currently-selected display (monitor or viewfinder) as they are taken.
[On (monitor only)]	Pictures are displayed after shooting only when the monitor is used to frame shots. Pictures are not displayed in the viewfinder when [Viewfinder only] is selected for monitor mode.
[Off]	Pictures can only be viewed by pressing the  button.

Rotate tall

MENU button ➔  playback menu

When [On] is selected, “tall” (portrait-orientation) pictures will be automatically rotated for display during playback.

Rotate tall

Images are not rotated automatically during picture review even when [On] is selected for [Rotate tall].

Slide show

MENU button ➔  playback menu

View a slide show; pictures are displayed in the order recorded. The pictures in the folder currently selected for [Playback folder] (□233) will be displayed one-by-one in the order recorded.

Option	Description
[Start]	Start the slide show.
[Picture type]	<ul style="list-style-type: none"> Choose the type of picture displayed. Select [By rating] to view only pictures with selected ratings. Highlight ratings and press \odot to select (<input checked="" type="checkbox"/>) or deselect (<input type="checkbox"/>)
[Frame interval]	Choose how long each picture will be displayed.

Viewing slide shows

To start the slide show, highlight **[Start]** and press \odot . The following operations can be performed while the slide show is in progress:

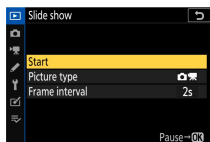

To	Description
Skip back/skip ahead	Press \odot to return to the previous frame, \odot to skip to the next frame.
View additional photo info	Press \odot or \odot to choose the photo info displayed. To hide photo info, select [None (picture only)] .
Pause	Press \odot to pause the slide show. To restart, highlight [Restart] and press \odot .
Adjust volume	Press \odot to increase volume, \odot (?) to decrease.
Exit to the playback menu	Press MENU to end the slide show and return to the playback menu.

To	Description
Exit to playback mode	Press ▶ to end the slide show and return to the playback display.
Resume shooting	Press the shutter-release button halfway to return to shooting mode.

A dialog is displayed when the show ends. To restart, highlight **[Restart]** and press **OK**. To end the show, highlight **[Exit]** and press **OK**.

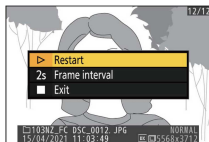

Rating

MENU button ➡ **▶** playback menu

Rate pictures.





- Highlight pictures using the multi selector **⬅** or **➡**.
- Press **⬆** or **⬇** to choose a rating of from zero to five stars, or select **✖** to mark the picture as a candidate for later deletion.
- To view the highlighted picture zoomed in, press and hold the **🔍** button.
- Press **OK** to save changes.

The photo shooting menu: Shooting options

To view the photo shooting menu, select the  tab in the camera menus.



The photo shooting menu contains the following items:

Item		Item	
[Reset photo shooting menu]	238	[Active D-Lighting]	262
[Storage folder]	238	[Long exposure NR]	262
[File naming]	242	[High ISO NR]	263
[Choose image area]	243	[Vignette control]	264
[Image quality]	244	[Diffraction compensation]	264
[Image size]	244	[Auto distortion control]	265
[RAW recording]	245	[Flicker reduction shooting]	265
[ISO sensitivity settings]	245	[Metering]	266
[White balance]	248	[Flash control]	267
[Set Picture Control]	255	[Flash mode]	269
[Manage Picture Control]	257	[Flash compensation]	269
[Color space]	262	[Release mode]	269

Item	📖	Item	📖
[Focus mode]	269	[HDR (high dynamic range)]	289
[AF-area mode]	270	[Interval timer shooting]	296
[Vibration reduction]	270	[Time-lapse video]	310
[Auto bracketing]	270	[Focus shift shooting]	319
[Multiple exposure]	281	[Silent photography]	327

✔ See also

“Photo shooting menu defaults” (📖216)

Reset photo shooting menu

MENU button ➡ 📷 photo shooting menu

Restore photo shooting menu options to their default values.

- Photo shooting menu reset is not available while a multiple exposure is in progress.

Storage folder

MENU button ➡ 📷 photo shooting menu

Choose the folder in which subsequent pictures will be stored.

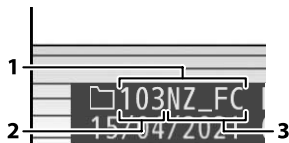

1 Folder

2 Folder number

3 Folder name

Renaming folders

The default folder name, which appears after the folder number, is “NZ_FC”. To change the name assigned to new folders, select **[Rename]**.

- Existing folders cannot be renamed.
- If desired, the default name can be restored for subsequent folders by pressing and holding the  button while the keyboard is displayed.

✔ Text entry



A keyboard is displayed when text entry is required.

- Tap letters on the screen to insert them at the current cursor position. You can also enter characters by highlighting them with the multi selector and pressing .



1 Text display area

2 Keyboard area

- To move the cursor to a new position, tap the display or rotate the main command dial.
- If a character is entered when the text display area is full, the rightmost character will be deleted.
- To delete the character under the cursor, press the  button.
- To complete entry, press .
- To exit without completing text entry, press **MENU**.

Select folder by number

The folder in which subsequent pictures will be stored can be selected by number. If a folder with the specified number does not already exist, a new folder will be created.

1 Choose [Select folder by number].



- Highlight [**Select folder by number**] and press \odot to display the [**Select folder by number**] dialog.

2 Choose a folder number.

- Press \odot or \odot to highlight digits.
- To change the highlighted digit, press \odot or \odot .

3 Save changes and exit.

- If a folder with the selected number already exists, a \square , \square , or \square icon will be displayed to the left of the folder number. Press \odot to complete the operation and return to the main menu; if you chose a folder marked \square or \square it will be selected as the folder for new pictures.
- If you chose a folder number that does not already exist, a new folder will be created with that number when you press \odot .
- In either case, subsequent pictures will be stored in the chosen folder.
- To exit without changing the storage folder, press the **MENU** button.

✓ Folder icons

Folders in the [**Select folder by number**] dialog are shown by \square if empty, \square if full (containing either 5000 pictures or a picture numbered 9999), or by \square if partially full. A \square icon indicates that no further pictures can be stored in the folder.

Select folder from list

To choose from a list of existing folders:

1 Choose [Select folder from list].

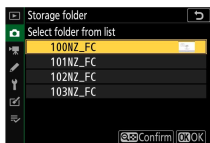

Highlight [**Select folder from list**] and press \rightarrow to display the [**Select folder from list**] dialog.

2 Highlight a folder.

Press \uparrow or \downarrow to highlight a folder.

3 Select the highlighted folder.

- Press \rightarrow to select the highlighted folder and return to the main menu.
- Subsequent photographs will be stored in the selected folder.

✔ Folder and file numbers

- Once the folder number has reached 999, the camera will stop creating new folders automatically and disable the shutter release if:
 - the current folder contains 5000 pictures (in addition, video recording will be disabled if the camera calculates that the number of files needed to record a video of the maximum length would result in the folder containing over 5000 files), or
 - the current folder contains a picture numbered 9999 (in addition, video recording will be disabled if the camera calculates that the number of files needed to record a video of the maximum length would result in a file numbered over 9999).
- If there is space on the memory card, you will nevertheless be able to continue shooting by:
 - creating a folder with a number less than 999 and selecting it as the storage folder, or
 - changing the options selected for **[Frame size/frame rate]** and **[Video quality]** before recording videos.

✔ Startup time

Additional time may be required for camera startup if the memory card contains a very large number of files or folders.

File naming

MENU button ➔  photo shooting menu

Pictures are saved using file names consisting of "DSC_" followed by a four-digit number and a three-letter extension. **[File naming]** is used to select three letters to replace the "DSC" portion of the file name. For information on text entry, see "Text entry" (☐239).

✔ File names

- File names take the form “DSC_nnnn.xxx”. nnnn is a number from 0001 to 9999. xxx is one of the following extensions, assigned according to the options selected for image quality and file type:
 - NEF: RAW photos
 - JPG: JPEG (fine, normal, or basic) photos
 - MOV: MOV videos
 - MP4: MP4 videos
 - NDF: Dust off reference data
- Images created with [Adobe RGB] selected for [Color space] have file names of the form “_DSCnnnn.xxx”.
- In each pair of photographs recorded at image-quality settings of RAW+JPEG, the RAW and JPEG images have the same file names but different extensions.

Choose image area

MENU button ➡  photo shooting menu

The camera offers a choice of the following image areas:





Option	Description
 [DX (24×16)]	Pictures are recorded with an image area of 23.5×15.7 mm (DX format). To calculate the approximate focal length of the lens in 35mm format, multiply by 1.5.
 [1:1 (16×16)]	Pictures are recorded with an aspect ratio of 1:1.
 [16:9 (24×14)]	Pictures are recorded with an aspect ratio of 16:9.

Image quality

MENU button ➡  photo shooting menu

Choose a file format for photographs. For more information, see “Image quality” in “The **i** menu” (□160).

Image size

MENU button ➡  photo shooting menu

Choose the size, in pixels, of pictures recorded with the camera. Note that image size varies with the option selected for image area.

Image area	Image size	Size (cm/in.) when printed at 300 dpi*
[DX (24×16)]	Large (5568 × 3712 pixels)	Approx. 47.1 × 31.4 cm/18.6 × 12.4 in.
	Medium (4176 × 2784 pixels)	Approx. 35.4 × 23.6 cm/13.9 × 9.3 in.
	Small (2784 × 1856 pixels)	Approx. 23.6 × 15.7 cm/9.3 × 6.2 in.
[1:1 (16×16)]	Large (3712 × 3712 pixels)	Approx. 31.4 × 31.4 cm/12.4 × 12.4 in.
	Medium (2784 × 2784 pixels)	Approx. 23.6 × 23.6 cm/9.3 × 9.3 in.
	Small (1856 × 1856 pixels)	Approx. 15.7 × 15.7 cm/6.2 × 6.2 in.
[16:9 (24×14)]	Large (5568 × 3128 pixels)	Approx. 47.1 × 26.5 cm/18.6 × 10.4 in.

Image area	Image size	Size (cm/in.) when printed at 300 dpi*
[16:9 (24×14)]	Medium (4176 × 2344 pixels)	Approx. 35.4 × 19.8 cm/13.9 × 7.8 in.
	Small (2784 × 1560 pixels)	Approx. 23.6 × 13.2 cm/9.3 × 5.2 in.

* Print size in inches equals image size in pixels divided by printer resolution in dots per inch (dpi; 1 inch = 2.54 cm).

RAW recording

MENU button →  photo shooting menu

Choose a bit depth for RAW pictures.

Option		Description
12-bit	[12-bit]	RAW pictures are recorded at a bit depth of 12 bits.
14-bit	[14-bit]	RAW pictures are recorded at a bit depth of 14 bits. Files recorded at a bit depth of 14 bits contain more color data than pictures recorded using [12-bit]. Files recorded at a bit depth of 14 bits are also larger than pictures recorded using [12-bit].

ISO sensitivity settings

MENU button →  photo shooting menu

Adjust the auto ISO sensitivity control settings for photographs. Auto ISO sensitivity control automatically adjusts ISO sensitivity if optimal

exposure cannot be achieved at the value selected by the user in modes **P**, **S**, **A**, and **M**.

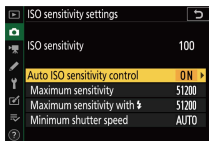

Option	Description
[ISO sensitivity]	The ISO sensitivity selected with the ISO sensitivity dial is displayed.
[Auto ISO sensitivity control]	Highlight [On] and press \odot to enable auto ISO sensitivity control. If [Off] is selected, the ISO sensitivity will remain fixed at the value selected with the ISO sensitivity dial.
[Maximum sensitivity]	Choose the upper limit for auto ISO sensitivity control to prevent it being raised too high.
[Maximum sensitivity with 	Choose the upper ISO sensitivity limit for photos taken using an optional flash unit.

Option	Description
<p>[Minimum shutter speed]</p>	<p>Choose the shutter speed (1/4000 to 30 s) below which auto ISO sensitivity control will kick in to prevent underexposure in modes P and A. If [Auto] is selected, the camera will choose the minimum shutter speed based on lens focal length. For example, the camera will automatically choose faster minimum shutter speeds to prevent blur caused by camera shake when a long lens is attached.</p> <ul style="list-style-type: none"> • To view auto shutter-speed selection options, highlight [Auto] and press . Auto shutter-speed selection can be fine-tuned by choosing faster or slower minimums. Faster settings can be used to reduce blur when photographing fast-moving subjects. • Shutter speeds may drop below the selected minimum if optimal exposure cannot be achieved at the ISO sensitivity chosen for [Maximum sensitivity].

- When auto ISO sensitivity control is enabled, the shooting display will show **ISO AUTO**. When sensitivity is altered from the value selected by the user, the ISO sensitivity will be shown in the displays.



✔ Auto ISO sensitivity control

- If the ISO sensitivity selected with the ISO sensitivity dial is higher than that set in [**Maximum sensitivity**], the value selected with the ISO sensitivity dial will serve as the maximum sensitivity.
- During flash photography, shutter speed is limited to the range defined by the values selected for Custom Settings e1 [**Flash sync speed**] and e2 [**Flash shutter speed**].

White balance

MENU button ➔ 📷 photo shooting menu

Adjust white balance to match the color of the light source. For more information, see “White balance” in “Basic settings” (☞116) and “White balance” in “The **i** menu” (☞153).

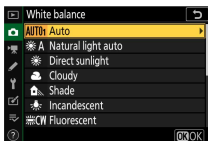

The white balance menu: Fine-tuning

- 1 Select [White balance] in the photo shooting menu, highlight the desired option, and press  as often as necessary to display fine-tuning options.

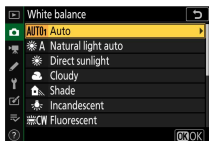

For information on fine-tuning PRE [Preset manual] white balance, see “Fine-tuning preset manual white balance” (□254).

2 Fine-tune white balance.

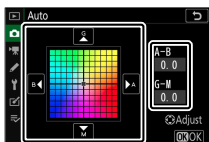

- The multi selector can be used to move the cursor up to six steps from the center of the grid along either of the A (amber)–B (blue) and G (green)–M (magenta) axes. The selected value is displayed to the right of the grid.
- The A (amber)–B (blue) axis corresponds to color temperature and is ruled in increments of 0.5. A change of 1 is equivalent to approximately 5 mired.
- The G (green)–M (magenta) axis has effects similar to color compensation filters and is ruled in increments of 0.25. A change of 1 is equivalent to approximately 0.05 diffuse density units.

3 Save changes.

- Press **OK** to save changes and exit to the menus.
- If white balance has been fine-tuned, an asterisk (“*”) will be displayed in the icon.



✓ White balance fine-tuning

The colors on the fine-tuning axes are relative, not absolute. Selecting more of a color on a given axis does not necessarily result in that color appearing in pictures. For example, moving the cursor to B (blue) when a “warm” setting such as **[Incandescent]** is selected will make pictures slightly “colder” but will not actually make them blue.

✓ “Mired”

Values in mired are calculated by multiplying the inverse of the color temperature by 10⁶. Any given change in color temperature produces a greater difference in color at low color temperatures than it would at higher color temperatures. For example, a change of 1000 K produces a much greater change in color at 3000 K than at 6000 K. Mired is a measure of color temperature that takes such variation into account, and as such is the unit used in color-temperature compensation filters.

E.g.: Change in color temperature (in Kelvin): Value in mired





- 4000 K – 3000 K = 1000 K: 83 mired
- 7000 K – 6000 K = 1000 K: 24 mired

The white balance menu: Choosing a color temperature

Choose a color temperature by entering values for the A (amber)–B (blue) and G (green)–M (magenta) axes.

1 Select [White balance] in the photo shooting menu, then highlight  [Choose color temperature] and press .

2 Choose a color temperature.

- Press  or  to highlight digits on the A–B (amber–blue) axis. You can also highlight the G–M (green–magenta) axis.
- Press  or  to edit the selected item.

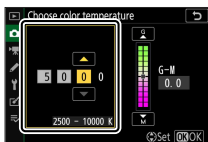

A–B (amber–blue) axis

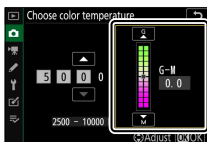

G–M (green–magenta)
axis

3 Save changes.

- Press  to save changes and exit to the menus.
- If a value other than 0 is selected for the green (G)–magenta (M) axis, an asterisk ("*") will appear in the icon.



✔ Color-temperature selection

- Do not use color-temperature selection with fluorescent light sources; instead, use the  [Fluorescent] option.
- When using color-temperature selection with other light sources, take a test shot to determine if the selected value is appropriate.

Preset manual: Copying white balance from a photograph

The white balance values for existing photographs can be copied to selected presets. For information on measuring new values for preset manual white balance, see “Preset manual” (☞156).

- 1 Select [White balance] in the photo shooting menu, then highlight PRE1 [Preset manual] and press .

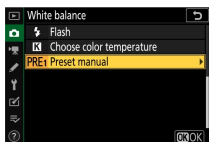

- 2 Select a destination.

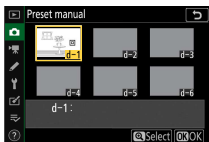

- Using the multi selector, highlight the destination preset (d-1 to d-6).
- Press ; a confirmation dialog will be displayed.

3 Choose [Select picture].

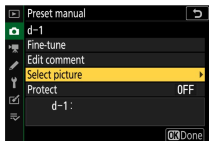

Highlight [**Select picture**] and press to view the pictures on the memory card.

4 Highlight the source image.

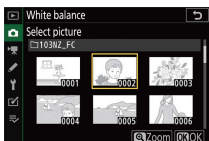

- Use the multi selector to highlight the desired picture.
- To view the highlighted picture zoomed in, press and hold the button.

5 Copy white balance.

- Press to copy the white balance value for the highlighted photograph to the selected preset.
- If the highlighted photograph has a comment, the comment will be copied to the comment for the selected preset.

✓ Fine-tuning preset manual white balance

The selected preset can be fine-tuned by selecting [**Fine-tune**] in the preset manual white balance menu (☰249).

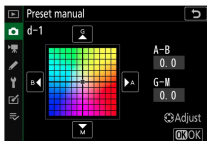

✓ “Edit comment”

To enter a descriptive comment of up to 36 characters for the current white-balance preset, select [**Edit comment**] in the preset manual white balance menu.



✓ “Protect”

To protect the current white-balance preset, select [**Protect**] in the preset manual white balance menu. Highlight [**On**] and press **OK**; the current white balance preset is now protected. Protected presets cannot be modified.

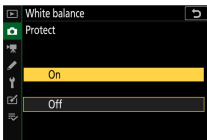

Set Picture Control

MENU button ➔ 📷 photo shooting menu

Choose image processing (“Picture Control”) options for new photos according to the scene or your creative intent. For more information, see “Set Picture Control” in “The **i** menu” (📖147).

Modifying Picture Controls from the menus

Existing preset or custom Picture Controls can be modified to suit the scene or the user’s creative intent.

1 Select a Picture Control.

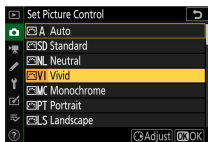

Highlight the desired Picture Control in the Picture Control list and press **↵**.

2 Edit the selected Picture Control.



- Press \odot or \ominus to highlight settings (151). Press \updownarrow or $\leftarrow\rightarrow$ to choose a value in increments of 1, or rotate the sub-command dial to choose a value in increments of 0.25.
- The options available vary with the Picture Control selected.
- To quickly adjust levels for balanced [**Sharpening**], [**Mid-range sharpening**], and [**Clarity**], highlight [**Quick sharp**] and press \updownarrow or $\leftarrow\rightarrow$.
- To abandon any changes and start over from default settings, press the trash button.

3 Save changes and exit.

Press OK to save changes.

✓ The **i** menu

- To select Picture Controls in the **i** menu, highlight [**Set Picture Control**] and press **OK**.

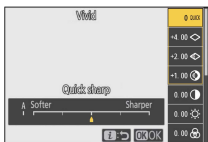

- Press **Left Arrow** and **Right Arrow** to choose a Picture Control and press **Down Arrow** to display Picture Control settings. The effect of any changes can be previewed in the display.

✓ [Manage Picture Control]

Modifications to existing Picture Controls can be saved using the [**Manage Picture Control**] item in the photo shooting menu or video recording menu, creating custom Picture Controls that can then be copied to a memory card and used in compatible software or shared among cameras of the same model.

Manage Picture Control

MENU button → photo shooting menu

Save modified Picture Controls as custom Picture Controls.

Option	Description
[Save/edit]	Create a new custom Picture Control based on an existing preset or custom Picture Control, or edit existing custom Picture Controls.
[Rename]	Rename custom Picture Controls.
[Delete]	Delete custom Picture Controls.

Option	Description
[Load/save]	Copy custom Picture Controls to and from the memory card.

Creating custom Picture Controls

1 Select [Save/edit].

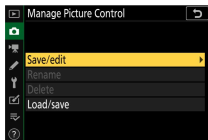

Highlight [**Save/edit**] and press \odot to view [**Choose Picture Control**] options.

2 Select a Picture Control.

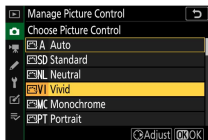

- Highlight an existing Picture Control and press \odot to display edit options.
- To save a copy of the highlighted Picture Control without further modification, press \odot . [**Save as**] options will be displayed; proceed to Step 4.

3 Edit the selected Picture Control.



- The settings available and the techniques for editing them are the same as for [Set Picture Control].
- Press **OK** to display [Save as] options when settings are complete.
- To abandon any changes and start over from default settings, press the **Reset** button.



4 Select a destination.



Choose a destination for the custom Picture Control (C-1 through C-9).

5 Name the Picture Control.



- Pressing  when a destination is highlighted in the previous step displays the **[Rename]** text-entry dialog.
- By default, new Picture Controls are named by adding a two-digit number to the name of the existing Picture Control. The two-digit number is assigned automatically.
- Custom Picture Control names can be up to nineteen characters long. New characters are added at the cursor position.
- To cycle through the upper- and lower-case and symbol keyboards, tap the keyboard selection button.
- For information on text entry, see “Text entry” (□239).
- When entry is complete, press  to save the new Picture Control.
- The new Picture Control will be added to the Picture Control list.

✔ The original Picture Control icon

The original preset Picture Control on which the custom Picture Control is based is indicated by an icon in the edit display.



✔ Custom Picture Control options

The options available with custom Picture Controls are the same as those on which the custom Picture Control was based.

✔ Load/save

The **[Load/save]** item in the **[Manage Picture Control]** menu can be used to copy custom Picture Controls from the camera to a memory card. You can also delete custom Picture Controls in a memory card, or copy them to the camera.

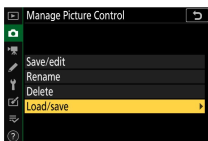

- **[Copy to camera]:** Copy (import) custom Picture Controls from the memory card to the camera. The Picture Controls are copied to custom Picture Controls C-1 through C-9 on the camera and can be named as desired.
 - **[Delete from card]:** Delete selected custom Picture Controls from the memory card.
 - **[Copy to card]:** Copy (export) a custom Picture Control from the camera to a memory card. Highlight a destination (1 through 99) for the selected Picture Control and press **[OK]** to export it to the memory card.
-

Color space

MENU button ➡  photo shooting menu

The color space determines the gamut of colors available for color reproduction. [sRGB] is recommended for general-purpose printing and display. With a broader gamut of colors than [sRGB], [Adobe RGB] is a better choice for professional publication and commercial printing.

✔ Color space

Third-party image viewing or editing software may substitute other color spaces for the color space selected on the camera. The color space selected on the camera can be used when pictures are opened in NX Studio.

✔ Adobe RGB

For accurate color reproduction, Adobe RGB images require applications, displays, and printers that support color management.

Active D-Lighting

MENU button ➡  photo shooting menu

Preserve details in highlights and shadows, creating pictures with natural contrast. For more information, see “Active D-Lighting” in “The **i** menu” (☞164).

Long exposure NR

MENU button ➡  photo shooting menu

Reduce “noise” (bright spots or fog) in photographs taken at slow shutter speeds.

Option	Description
[On]	Reduce noise in photographs taken at shutter speeds slower than 1 s.
[Off]	Long-exposure noise reduction disabled.

Long-exposure noise reduction is performed after the photo is taken. During processing, [**Performing noise reduction**] will appear in the shooting display. Pictures cannot be taken until the message has cleared from the display. The time required to process photos after shooting roughly doubles.

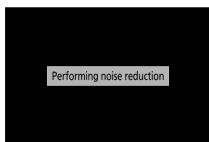

✓ Long-exposure noise reduction

If the camera is turned off before processing is complete, the picture will be saved but noise reduction will not be performed.

High ISO NR

MENU button → 📷 photo shooting menu

Photographs taken at high ISO sensitivities can be processed to reduce “noise” (randomly-spaced bright pixels).

Option	Description
[High]	Reduce noise in photographs taken at all ISO sensitivities. The higher the sensitivity, the greater the effect. Choose the amount of noise reduction performed from [High], [Normal], and [Low].
[Normal]	
[Low]	

Option	Description
[Off]	Noise reduction is performed only as required. The amount of noise reduction performed is always lower than when [Low] is selected.

Vignette control

MENU button →  photo shooting menu

Vignette control reduces “vignetting”—a drop in brightness at the edges of a photograph—by an amount that varies from lens to lens. Its effects are most noticeable at maximum aperture.

Option	Description
<input type="checkbox"/> H [High]	Choose the amount of vignette control performed from (in order from high to low) [High], [Normal], and [Low].
<input type="checkbox"/> N [Normal]	
<input type="checkbox"/> L [Low]	
[Off]	Vignette control disabled.

Vignette control

Depending on the scene, shooting conditions, and type of lens, JPEG images may exhibit “noise” (fog) or over-processing at the edge of the frame that introduces variations in peripheral brightness. In addition, custom Picture Controls and preset Picture Controls that have been modified from default settings may not produce the desired effect. Take test shots and view the results in the monitor.

Diffraction compensation

MENU button →  photo shooting menu

Select [On] to reduce diffraction at small apertures (high f/-numbers).

Auto distortion control

MENU button ➔  photo shooting menu

Select [**On**] as required to reduce barrel distortion when shooting with wide-angle lenses and to reduce pin-cushion distortion when shooting with long lenses. Note that [**On**] may be selected automatically with some lenses, in which case this item will be grayed out and unavailable.

Flicker reduction shooting

MENU button ➔  photo shooting menu

When [**On**] is selected, reduce the effects of flicker from such light sources as fluorescent or mercury-vapor lamps.

- Flicker can cause uneven exposure or (in photographs taken in continuous release modes) inconsistent exposure or coloration.
- Note that the frame rate for burst shooting may drop or become erratic when [**On**] is selected.

✔ **Flicker reduction shooting in the photo shooting menu**

- Depending on the light source, flicker reduction may slightly delay shutter response.
- Flicker reduction can detect flicker at 100 and 120 Hz (associated respectively with AC power supplies of 50 and 60 Hz). The desired results may not be achieved if the frequency of the power supply changes during burst photography.
- Flicker may not be detected or the desired results may not be achieved depending on the light source and shooting conditions, for example with scenes that are brightly lit or feature dark backgrounds.
- The desired results may also not be achieved with decorative lighting displays and other non-standard lighting.

✔ **[Flicker reduction shooting] in the photo shooting menu: Restrictions**

The **[Flicker reduction shooting]** item in the photo shooting menu does not take effect under some conditions, including when:

- **[Continuous H (extended)]** is selected for the release mode
- **[On]** is selected for **[Silent photography]** in the photo shooting menu
- **[On]** is selected for **[Silent photography]** in the respective sub-menu during interval-timer photography, time-lapse video recording, or focus shift
- HDR is enabled
- Exposure delay mode is on

Metering

MENU button ➡  photo shooting menu

Metering determines how the camera sets exposure. For more information, see “Metering” in “The **i** menu” (□162).

Flash control

MENU button ➡ 📷 photo shooting menu

Adjust settings for wireless remote flash units or optional flash units mounted on the camera accessory shoe.

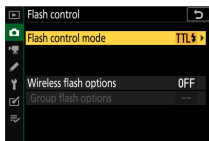

- For information on adjusting settings for optional flash units mounted on the camera accessory shoe, see “On-Camera flash photography” (□497).
- For information on adjusting settings for wireless remote flash units, see “Remote flash photography” (□508).

Flash control mode

Choose a flash control mode and flash level and adjust other settings for SB-500, SB-400, or SB-300 flash units mounted on the camera accessory shoe.

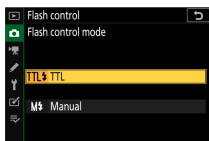

- Settings for flash units other than the SB-500, SB-400, and SB-300 can only be adjusted using flash unit controls.

Option	Description
[TTL]	Flash output is adjusted automatically in response to shooting conditions.

Option	Description
[Manual]	Choose the flash level manually.

Wireless flash options

Adjust settings for simultaneous wireless control of multiple remote flash units. This option is available only when an SB-500 flash unit is mounted on the camera.

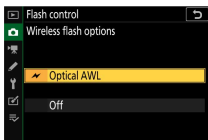

Option	Description
⚡ [Optical AWL]	The remote flash units are controlled using low-intensity flashes emitted by the master flash (□509).
[Off]	Remote flash photography disabled.

Group flash options

Set flash options for each group when shooting with remote flash photography using an optional flash unit (□508). This option is available only when an SB-500 flash unit is mounted on the camera.

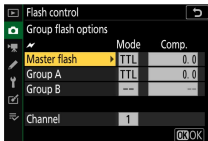

Flash mode

MENU button ➡  photo shooting menu

Choose a flash mode for optional flash units. For more information, see “Flash modes” in “On-Camera flash photography” (□502).

Flash compensation

MENU button ➡  photo shooting menu

Adjust flash output to control the brightness of the main subject relative to the background. Flash output can be increased to make the main subject appear brighter, reduced to prevent glare, or otherwise fine-tuned to produce the desired result (□504).

Release mode

MENU button ➡  photo shooting menu

Choose the operation performed when the shutter is released. For more information about release modes, see “Release mode” in “The **i** menu” (□166).

Focus mode

MENU button ➡  photo shooting menu

Focus mode controls how the camera focuses. For more information, see “Focus mode” in the “Focus” section of “Basic settings” (□100).

AF-area mode

MENU button ➔  photo shooting menu

Choose how the camera selects the focus point for autofocus. For more information, see “AF-area mode” in the “Focus” section of “Basic settings” (□102).

Vibration reduction

MENU button ➔  photo shooting menu

Choose whether to enable vibration reduction. For more information, see “Vibration reduction” in “The  menu” (□171).

Auto bracketing

MENU button ➔  photo shooting menu

Vary exposure, flash level, Active D-Lighting (ADL), or white balance slightly with each shot, “bracketing” the current value. Bracketing can be used in situations in which getting the right settings is difficult and there is not time to check results and adjust settings with each shot, or to experiment with different settings for the same subject.

Option	Description
[Auto bracketing set]	<p>Choose the setting or settings bracketed when auto bracketing is in effect.</p> <ul style="list-style-type: none">• [AE & flash bracketing]: Perform both exposure and flash-level bracketing.• [AE bracketing]: Bracket only exposure.• [Flash bracketing]: Perform only flash-level bracketing.• [WB bracketing]: Perform white-balance bracketing.• [ADL bracketing]: Perform bracketing using Active D-Lighting.

Option	Description
[Number of shots]	Choose the number of shots in the bracketing sequence.
[Increment]	Choose the amount the selected settings vary with each shot when an option other than [ADL bracketing] is selected for [Auto bracketing set].
[Amount]	Choose how Active D-Lighting varies with each shot when [ADL bracketing] is selected for [Auto bracketing set].

Exposure and flash bracketing



No exposure compensation





Exposure modified by: -1 EV



Exposure modified by: +1 EV

- 1 Select [AE & flash bracketing], [AE bracketing], or [Flash bracketing] for [Auto bracketing set].
[Number of shots] and [Increment] options will be displayed.

2 Choose the number of shots.



- Highlight [**Number of shots**] and press  or  to choose the number of shots in the bracketing sequence.



- At settings other than [**0F**], a bracketing icon will appear in the display.



3 Select an exposure increment.

- Highlight [**Increment**] and press  or  to choose the bracketing increment.
- The size of the increment can be chosen from 0.3 (1/3 step), 0.7 (2/3 step), 1.0 (1 step), 2.0 (2 steps), or 3.0 (3 steps). Bracketing programs with an increment of 2.0 or 3.0 EV offer a maximum of 5 shots. If a value of 7 or 9 was selected in Step 2, the number of shots will automatically be set to 5.
- The bracketing programs with an increment of 0.3 EV are listed below.

[Number of shots]	Exposure and flash bracketing indicator	No. of shots	Bracketing order (EVs)
0F	-.....0.....+	0	0
+3F	-.....0 +	3	0/+0.3/+0.7
-3F	-.....0 +	3	0/-0.7/-0.3
+2F	-.....0 +	2	0/+0.3
-2F	-.....0 +	2	0/-0.3
3F	-.....0 +	3	0/-0.3/+0.3
5F	-.....0 +	5	0/-0.7/-0.3/+0.3/+0.7
7F	-.....0 +	7	0/-1.0/-0.7/-0.3/+0.3/+0.7/+1.0

[Number of shots]	Exposure and flash bracketing indicator	No. of shots	Bracketing order (EVs)
9F	-.....0.....+	9	0/-1.3/-1.0/-0.7/-0.3/+0.3/ +0.7/+1.0/+1.3

4 Take pictures.

- Take the number of pictures in the bracketing program.
- The modified values for shutter speed and aperture are shown in the display.
- While bracketing is in effect, the display shows a bracketing icon, a bracketing progress indicator, and the number of shots remaining in the bracketing sequence. After each shot, a segment will disappear from the indicator and the number of shots remaining will be reduced by one.



No. shots: 3
Increment: 0.7



Display after first shot

- Exposure changes due to bracketing are added to those made with exposure compensation.

■ Cancelling bracketing

To cancel bracketing, select [OF] for [Number of shots].

✔ Bracketing options

When [**AE & flash bracketing**] is selected, the camera varies both exposure and flash level. Select [**AE bracketing**] to vary only exposure, [**Flash bracketing**] to vary only flash level. Note that flash bracketing is available in i-TTL and, where supported, auto aperture (Ⓐ) flash control modes only (□499, □543).

✔ Exposure and flash bracketing

- In continuous release modes, shooting will pause after the number of shots specified in the bracketing program have been taken. Shooting will resume the next time the shutter-release button is pressed.
- If the camera is turned off before all shots in the sequence have been taken, bracketing will resume from the first shot in the sequence when the camera is turned on.
- If the memory card fills before all shots in the sequence have been taken, shooting can be resumed from the next shot in the sequence after the memory card has been replaced.

✔ Exposure bracketing

The settings (shutter speed and/or aperture) altered during exposure bracketing vary with the shooting mode.

Mode	Setting
P	Shutter speed and aperture ¹
S	Aperture ¹
A	Shutter speed ¹
M	Shutter speed ^{2,3}

- 1 If [**On**] is selected for [**ISO sensitivity settings**] > [**Auto ISO sensitivity control**] in the photo shooting menu, the camera will automatically vary ISO sensitivity for optimum exposure when the limits of the camera exposure system are exceeded.

- If **[On]** is selected for **[ISO sensitivity settings] > [Auto ISO sensitivity control]** in the photo shooting menu, the camera will first use auto ISO sensitivity control to bring exposure as close as possible to the optimum and then bracket this exposure by varying shutter speed.
- Use Custom Setting e5 **[Auto bracketing (mode M)]** to choose whether the camera varies shutter speed, aperture, or both shutter speed and aperture.

White balance bracketing

1 Select **[WB bracketing]** for **[Auto bracketing set]**.

[Number of shots] and **[Increment]** options will be displayed.

2 Choose the number of shots.

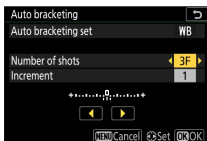

- Highlight **[Number of shots]** and press \leftarrow or \rightarrow to choose the number of shots in the bracketing sequence.



- At settings other than **[OF]**, a bracketing icon will appear in the display.



3 Select a white balance increment.

- Highlight [**Increment**] and press  or  to choose the bracketing increment.
- The size of the increment can be chosen from 1 (1 step), 2 (2 steps), or 3 (3 steps).
- Each step is equivalent to 5 mired. Higher “A” values correspond to increased amounts of amber. Higher “B” values correspond to increased amounts of blue.
- The bracketing programs with an increment of 1 are listed below.

[Number of shots]	White balance bracketing indicator	No. of shots	White balance increment	Bracketing order
0F	+.....0.....+	0	1	0
B3F	+.....:0.....+	3	1B	0/B1/B2
A3F	+.....0:.....+	3	1A	0/A2/A1
B2F	+.....:0.....+	2	1B	0/B1
A2F	+.....0:.....+	2	1A	0/A1
3F	+.....:0.....+	3	1A, 1B	0/A1/B1
5F	+.....:0:.....+	5	1A, 1B	0/A2/A1/B1/B2
7F	+.....:0:.....+	7	1A, 1B	0/A3/A2/A1/B1/B2/B3

[Number of shots]	White balance bracketing indicator	No. of shots	White balance increment	Bracketing order
9F	+.....:0:.....+	9	1A, 1B	0/A4/A3/A2/A1 /B1/B2/B3/B4

4 Take pictures.

- Each shot will be processed to create the number of copies specified in the bracketing program, and each copy will have a different white balance.
- Modifications to white balance are added to the white balance adjustment made with white balance fine-tuning.
- If the number of shots in the bracketing program is greater than the number of exposures remaining, the shutter release will be disabled. Shooting can begin when a new memory card is inserted.

■ ■ Cancelling bracketing

To cancel bracketing, select [0F] for [Number of shots].

✓ White balance bracketing restrictions

White balance bracketing is not available at image quality settings of RAW or RAW + JPEG.

✓ White balance bracketing

- White balance bracketing affects only color temperature (the amber–blue axis in the white balance fine-tuning display). No adjustments are made on the green–magenta axis.
- If the camera is turned off while shooting, the camera will power off only after all photographs have been taken.
- In self-timer mode, the number of copies specified in Step 2 of “White balance bracketing” (□276) will be created each time the shutter is released, regardless of the option selected for Custom Setting c2 [Self-timer] > [Number of shots].

ADL bracketing

1 Select [ADL bracketing] for [Auto bracketing set].

[Number of shots] and [Amount] options will be displayed.

2 Choose the number of shots.

- Highlight [Number of shots] and press \odot or \odot to choose the number of shots in the bracketing sequence.

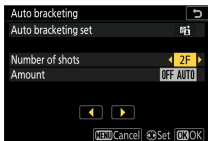

- At settings other than [OF], a bracketing icon will appear in the display.



- The number of shots determines the bracketing sequence:

No. of shots	Bracketing sequence
2	[Off]→Value selected in Step 3
3	[Off]→[Low]→[Normal]
4	[Off]→[Low]→[Normal]→[High]
5	[Off]→[Low]→[Normal]→[High]→[Extra high]

- If you chose more than two shots, proceed to Step 4.

3 If you selected 2 shots, choose the Active D-Lighting amount.

- When the number of shots is 2, the Active D-Lighting setting for the second shot can be selected by highlighting **[Amount]** and pressing \odot or \odot .
- The following options are available.

[Amount]	Bracketing sequence
OFF L	[Off] → [Low]
OFF N	[Off] → [Normal]
OFF H	[Off] → [High]
OFF H+	[Off] → [Extra high]
OFF AUTO	[Off] → [Auto]

4 Take pictures.



- Take the number of pictures in the bracketing program.
- While bracketing is in effect, the display shows an ADL bracketing icon and the number of shots remaining in the bracketing sequence. After each shot, the number of shots remaining will be reduced by one.



■ ■ Cancelling ADL bracketing

To cancel bracketing, select [OF] for [Number of shots].

✓ ADL bracketing



- In continuous release modes, shooting will pause after the number of shots specified in the bracketing program have been taken. Shooting will resume the next time the shutter-release button is pressed.
- If the camera is turned off before all shots in the sequence have been taken, bracketing will resume from the first shot in the sequence when the camera is turned on.
- If the memory card fills before all shots in the sequence have been taken, shooting can be resumed from the next shot in the sequence after the memory card has been replaced.

Multiple exposure

MENU button ➔  photo shooting menu

Record two to ten RAW exposures as a single photograph.

Option	Description
[Multiple exposure mode]	<ul style="list-style-type: none">• [On (series)]: Take a series of multiple exposures. To end multiple exposure photography, select [Multiple exposure mode] again and choose [Off].• [On (single photo)]: Create one multiple exposure.• [Off]: End multiple exposure photography.
[Number of shots]	Choose the number of exposures that will be combined to form a single photograph.

Option	Description
<p>[Overlay mode]</p>	<ul style="list-style-type: none"> • [Add]: The exposures are overlaid without modification; gain is not adjusted. • [Average]: Gain is adjusted before the exposures are overlaid. The gain for each exposure is equal to 1 divided by the total number of exposures taken. For example, in a photo made by combining two exposures, the gain for each exposure will be set to 1/2, while in a photo combining three exposures, gain will be set to 1/3. • [Lighten]: The camera compares the pixels in each picture and uses only the brightest.  <ul style="list-style-type: none"> • [Darken]: The camera compares the pixels in each picture and uses only the darkest. 
<p>[Save individual pictures (RAW)]</p>	<ul style="list-style-type: none"> • [On]: Save both the multiple exposure and the shots that make it up; the pictures are saved in RAW format. • [Off]: Discard the individual shots and save only the multiple exposure.
<p>[Overlay shooting]</p>	<ul style="list-style-type: none"> • [On]: Earlier exposures are superimposed on the view through the lens. The earlier exposures aid composition of the next shot. • [Off]: Earlier exposures are not displayed while shooting is in progress.

Option	Description
[Select first exposure (RAW)]	Choose the first exposure from the RAW images on the memory card.



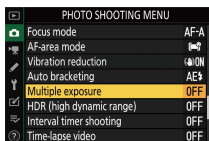

Creating a multiple exposure

- 1 Highlight [Multiple exposure] in the photo shooting menu and press .

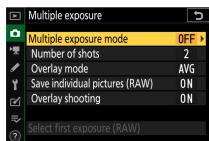

- 2 Choose an option for [Multiple exposure mode].



- Highlight [Multiple exposure mode] and press .
- Highlight a multiple exposure mode using  or  and press .
- If [On (series)] or [On (single photo)] is selected, an icon will appear in the display.



3 Choose a value for [Number of shots] (number of exposures).

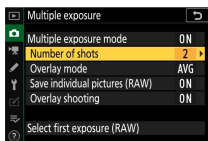

- Highlight [**Number of shots**] and press
- Choose the number of exposures using or and press .

4 Choose an option for [Overlay mode].

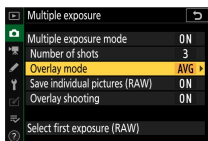

- Highlight [**Overlay mode**] and press .
- Highlight an option using or and press .

5 Choose a setting for [Save individual pictures (RAW)].

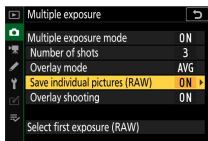

- Highlight [**Save individual pictures (RAW)**] and press .
- Highlight an option using or and press .
- To save both the multiple exposure and the shots that make it up, select [**On**]; the individual shots are saved in RAW format. To save only the multiple exposure, select [**Off**].

6 Choose an option for [Overlay shooting].

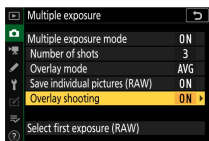

- Highlight [**Overlay shooting**] and press \odot .
- Highlight an option using \uparrow or \downarrow and press \odot .
- Select [**On**] to superimpose earlier exposures on the view through the lens. You can use the earlier exposures as a guide when composing subsequent shots.

7 Choose an option for [Select first exposure (RAW)].



- To choose the first exposure from existing RAW pictures, highlight [**Select first exposure (RAW)**] and press \odot .
- Use the multi selector to highlight the desired picture.
- To view the highlighted picture zoomed in, press and hold the \otimes button.
- After highlighting the desired picture, press \odot .

8 Start shooting.



- Take the selected number of shots. If you used [**Select first exposure (RAW)**] to select an existing RAW image as the first exposure in Step 7, shooting will start from the second exposure.
- Once you have taken the selected number of shots, the pictures will be overlaid to create a multiple exposure.
- If [**On (series)**] is selected for [**Multiple exposure mode**], you can continue to take additional multiple exposures until [**Off**] is selected.
- If [**On (single photo)**] is selected, the camera will exit multiple exposure mode once the number of shots selected in Step 3 has been taken.



✓ Saved overlays

If you took pictures with the image quality set to RAW, JPEG images in the [**JPEG fine**] image quality will be saved.

■ The *i* menu

Pictures can be viewed by pressing the  button while a multiple exposure is in progress. The most recent shot in the current multiple

exposure is indicated by a  icon; pressing the **i** button when this icon is present displays the multiple exposure **i** menu.

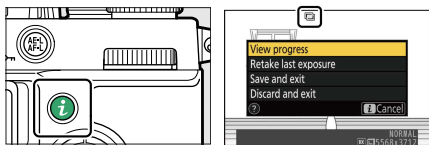

- Highlight items and press **OK** to select.
- You can also have the option of using touch controls after pressing the **i** button.

Option	Description
[View progress]	View a preview created from the exposures recorded to the current point.
[Retake last exposure]	Retake the most recent exposure.
[Save and exit]	Create a multiple exposure from the exposures taken to current point.
[Discard and exit]	Exit without recording a multiple exposure. <ul style="list-style-type: none"> • If [On] is selected for [Save individual pictures (RAW)], the individual exposures will be saved separately.

✔ **Multiple exposure**

- If you use the menus or view pictures in the display while shooting a multiple exposure, remember that shooting will end and the multiple exposure will be recorded if no operations are performed for about 40 seconds (or in the case of menus, about 90 seconds). The time available to record the next exposure can be extended by choosing longer times for Custom Setting c3 [**Power off delay**] > [**Playback**] or [**Menus**].
- Multiple exposures may be affected by “noise” in the form of randomly spaced bright pixels, fog, or lines.
- In continuous shooting modes, the camera records all exposures in a single burst. If [**On (single photo)**] is selected, multiple exposure shooting will end after the first multiple exposure is recorded. If [**On (series)**] is selected, an additional multiple exposure will be recorded each time the shutter-release button is pressed.
- In self-timer mode, the interval between each shot in the exposure is selected using Custom Setting c2 [**Self-timer**] > [**Interval between shots**]. Regardless of the value selected for the c2 [**Number of shots**] option, shooting will however end after the number of shots selected for the multiple exposure.
- Multiple exposures may end if settings are changed while shooting is in progress.
- Shooting settings and photo info for multiple exposure photographs are those for the first exposure.
- Do not remove or replace the memory card while a multiple exposure is in progress.
- Memory cards cannot be formatted while a multiple exposure is in progress. Some menu items will be grayed out and unavailable.

✔ **Multiple exposure: Restrictions**

Multiple exposure cannot be combined with some camera features, including:

- modes other than **P**, **S**, **A**, and **M**,
- video recording,
- bracketing,



- HDR (high dynamic range),
- interval-timer photography,
- time-lapse video recording, and
- focus shift

Ending multiple exposures

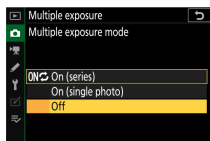

To end a multiple exposure before the specified number of exposures have been taken, select [**Off**] for multiple exposure mode. A multiple exposure will be created from the exposures that have been recorded to that point (if [**Average**] is selected for [**Overlay mode**], gain will be adjusted to reflect the number of exposures actually recorded).



The multiple exposure will also end if:

- the standby timer expires after the first exposure has been taken, or
- you press the  button followed by the  button and select either [**Save and exit**] or [**Discard and exit**]

HDR (high dynamic range)

MENU button   photo shooting menu

Used with high contrast subjects, High Dynamic Range (HDR) preserves details in highlights and shadows by combining two shots taken at

different exposures. Use with high-contrast scenes and other subjects to preserve a wide range of details, from highlights to shadows.



Option	Description
[HDR mode]	<ul style="list-style-type: none">• [On (series)]: Take a series of HDR photographs. To end HDR photography, select [HDR mode] again and choose [Off].• [On (single photo)]: Take a single HDR photograph.• [Off]: End HDR photography.
[Exposure differential]	Choose the difference in exposure between the two shots. The higher the value, the greater the dynamic range. If [Auto] is selected, the camera will automatically adjust the exposure differential to suit the scene.
[Smoothing]	Choose how much the boundaries between the two images are smoothed.
[Save individual pictures (RAW)]	Choose [On] to save each of the individual shots used to create the HDR image; the shots are saved in RAW format.

Taking HDR photographs

We recommend that you use the matrix metering option when shooting with HDR.

1 Highlight [HDR (high dynamic range)] in the photo shooting menu and press .

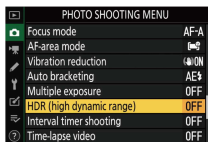

2 Select an [HDR mode].

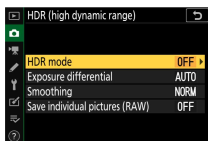

- Highlight [**HDR mode**] and press \odot .
- Highlight one of the following options using \odot or \ominus and press \odot .

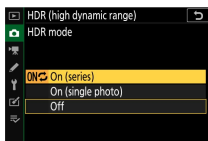





Option	Description
ON \odot [On (series)]	Take a series of HDR photographs. HDR shooting will continue until you select [Off] for [HDR mode].
[On (single photo)]	Normal shooting will resume after you have taken a single HDR photograph.
[Off]	Proceed without taking additional HDR photographs.

- If [**On (series)**] or [**On (single photo)**] is selected, an icon will appear in the display.

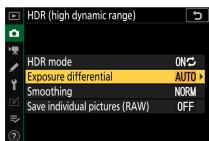

3 Choose a value for [Exposure differential].



- Highlight [**Exposure differential**] and press .
- Highlight an option using  or  and press .

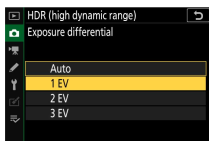

- Choose higher values for high-contrast subjects.
- Note, however, that choosing a higher value than required may not produce the desired results. Match your choice to the level of contrast in the scene.
- If [**Auto**] is selected, the camera will automatically adjust the exposure differential to suit the scene.

4 Adjust [Smoothing].

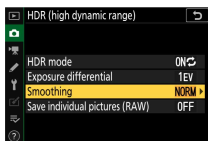

- Highlight [**Smoothing**] and press \odot .
- Highlight an option using \uparrow or \downarrow and press \odot ; the selected option represents the amount the boundaries between the two images are smoothed.

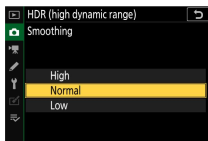

- Higher values produce a smoother composite image.

5 Choose a setting for [Save individual pictures (RAW)].

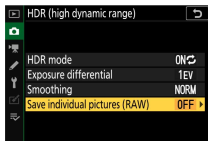

- Highlight [**Save individual pictures (RAW)**] and press \odot .
- Highlight an option using \uparrow or \downarrow and press \odot .
- Choose [**On**] to save each of the individual shots used to create the HDR image; the shots are saved in RAW format.

6 Frame the photograph, focus, and shoot.

- The camera takes two exposures when the shutter-release button is pressed all the way down.
- If [**On (series)**] is selected for [**HDR mode**], you can continue to take HDR photographs until [**Off**] is selected.
- If [**On (single photo)**] is selected, HDR will turn off automatically after a single shot.
- HDR photographs are recorded in JPEG format regardless of the option selected for image quality.

✔ HDR photography

- The edges of the image will be cropped out.
- The desired results may not be achieved if the camera or subject moves during shooting. Use of a tripod is recommended.
- Depending on the scene, you may notice shadows around bright objects or halos around dark objects. This can be mitigated using [**Smoothing**].
- Uneven shading may be visible with some subjects.
- With spot or center-weighted metering, an [**Exposure differential**] of [**Auto**] is equivalent to [**2 EV**].
- Optional flash units will not fire.
- In continuous release modes, only one photograph will be taken each time the shutter-release button is pressed all the way down.
- Long exposure (“Bulb” or “Time”) photography is not available. If you set the shutter-speed dial to **Bulb** or **Time**, the **Bulb** or **Time** indicator flashes in the display.

✔ HDR restrictions

HDR cannot be combined with some camera features, including:

- modes other than **P**, **S**, **A**, and **M**,
- flicker reduction,
- bracketing,
- multiple exposures,
- interval-timer photography,
- time-lapse video recording, and
- focus shift

Interval timer shooting

MENU button ➔  photo shooting menu

Take photographs at the selected MENU interval until the specified number of shots has been recorded. When using the interval timer, select a release mode other than .

Option	Description
[Start]	Start interval timer shooting. Shooting will begin either after 3 s ([Now] selected for [Choose start day/time]) or at a selected date and time ([Choose day/time]). Shooting will continue at the selected interval until all shots have been taken.
[Choose start day/time]	Choose a start option. Select [Now] to start shooting immediately, [Choose day/time] to start shooting at a chosen date and time.
[Interval]	Specify the interval between shots in hours, minutes, and seconds.
[Intervalsxshots/interval]	Choose the number of intervals and the number of shots per interval.
[Exposure smoothing]	<p>Selecting [On] allows the camera to adjust exposure to match the previous shot.</p> <ul style="list-style-type: none"> • Large changes in subject brightness during shooting may result in apparent variations in exposure. This can be addressed by shortening the interval between shots. • Exposure smoothing will not take effect in mode M if [Off] is selected for [ISO sensitivity settings] > [Auto ISO sensitivity control] in the photo shooting menu.
[Silent photography]	<p>Select [On] to silence the shutter and eliminate the vibrations it produces during shooting.</p> <ul style="list-style-type: none"> • Selecting [On] does not completely silence the camera. Camera sounds may still be audible, for example during autofocus or aperture adjustment, in the latter case most noticeably at apertures smaller (i.e., at f-numbers higher) than f/5.6.

Option	Description
[Interval priority]	<ul style="list-style-type: none"> • [On]: Enable interval priority to ensure that frames shot in modes P and A are taken at the chosen interval. <ul style="list-style-type: none"> - Select [Release] for Custom Setting a2 [AF-S priority selection] when AF-S is selected for focus mode and for Custom Setting a1 [AF-C priority selection] when AF-C is selected. - If [ISO sensitivity settings] > [Auto ISO sensitivity control] in the photo shooting menu is set to [On], set [Minimum shutter speed] so that it is shorter than the shooting interval. • [Off]: Disable interval priority to ensure that photos are correctly exposed.
[Focus before each shot]	If [On] is selected, the camera will focus between shots.

Option	Description
[Options]	<p>Combine interval-timer photography with other options.</p> <ul style="list-style-type: none"> • [AE bracketing]: Perform exposure bracketing during interval-timer photography. • [Time-lapse video]: Use the photos taken during interval-timer photography to create a time-lapse video with an aspect ratio of 16:9. <ul style="list-style-type: none"> - The camera saves both the photos and the time-lapse video. - Selecting [1:1 (16×16)] for [Choose image area] in the photo shooting menu disables the shutter release. - Videos created using [Time-lapse video] are recorded in the [sRGB] color space, regardless of the option selected for [Color space] in the photo shooting menu. • [Off]: Do not perform additional operations during interval-timer photography.
[Starting storage folder]	<p>Highlight an option and press  to select (<input checked="" type="checkbox"/>) or deselect (<input type="checkbox"/>)</p> <ul style="list-style-type: none"> • [New folder]: A new folder is created for each new sequence. • [Reset file numbering]: File numbering is reset to 0001 whenever a new folder is created.

Interval-timer photography

✓ Before shooting

- Take a test shot at current settings.
- Before proceeding, select [**Time zone and date**] in the setup menu and make sure that the camera clock is set to the correct time and date.
- To ensure that shooting is not interrupted, use a fully-charged battery or an optional charging AC adapter.

1 Highlight [Interval timer shooting] in the photo shooting menu.

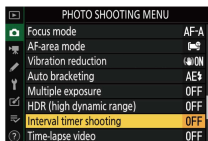

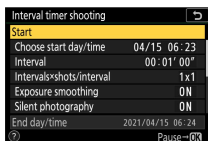

Press  to select the highlighted item and view interval timer shooting options.



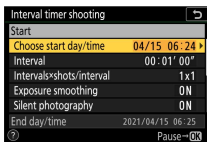

2 Adjust interval timer settings.

- Choose the start day and time.

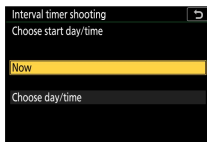

Highlight [**Choose start day/time**] and press .



Highlight an option and press .

- To start shooting immediately, select [**Now**].
- To start shooting at a chosen date and time, select [**Choose day/time**]. Choose the date and time and press .

- Choose the interval between shots.

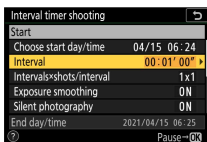

Highlight [**Interval**] and press .

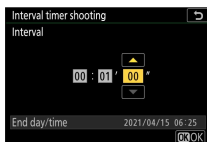

Choose an interval (in hours, minutes, and seconds) and press .

• **Choose the number of shots per interval.**

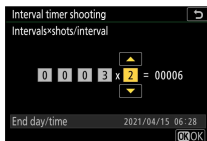
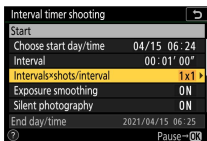

Highlight
[**Intervalsxshots/
interval**] and press \blacktriangleleft .

Choose the number of
intervals and the number
of shots per interval and
press \odot .

- In single frame release mode, if the number of shots per interval is set to two or more, the photographs for each interval will be taken at the rate for continuous high-speed release mode.
- When [**Off**] is selected for [**Silent photography**], the maximum number of intervals will vary with the number of shots per interval.

• **Enable or disable exposure smoothing.**

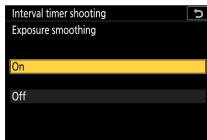
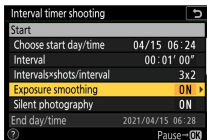

Highlight [**Exposure
smoothing**] and press \blacktriangleleft .

Highlight an option and
press \odot .

- Selecting [**On**] allows the camera to adjust exposure to match the previous shot.

• **Enable or disable silent photography.**

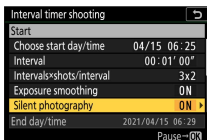

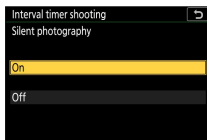

Highlight [**Silent photography**] and press



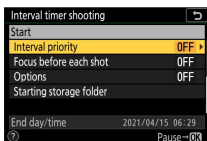

Highlight an option and press .

• **Choose an interval priority option.**



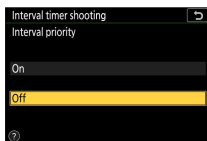

Highlight [**Interval priority**] and press .

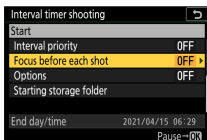

Highlight an option and press .

• **Choose whether the camera focuses between shots.**



Highlight [**Focus before each shot**] and press .



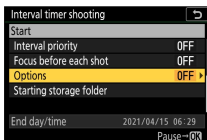

Highlight an option and press .

• **Choose additional options.**

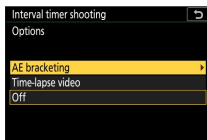

Highlight [**Options**] and press .



Highlight [**AE bracketing**] or [**Time-lapse video**] and press .

- If you selected [**AE bracketing**], choose values for [**Number of shots**] and [**Increment**]; if you selected [**Time-lapse video**], choose a setting for [**Frame size/frame rate**].

• **Choose starting folder options.**

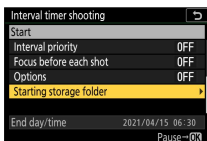

Highlight [**Starting storage folder**] and press .

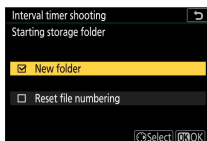

Select the desired options and press  to proceed.

3 Highlight [Start] and press .

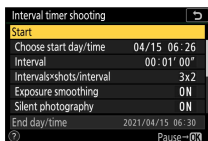

- If [**Now**] was selected for [**Choose start day/time**] in Step 2, shooting will start after three seconds.
- Otherwise shooting will start at the time selected for [**Choose start day/time**] > [**Choose day/time**].
- The display turns off during shooting.
- Shooting will continue at the selected interval until all shots have been taken.

During shooting

- During interval timer photography, the memory card access lamp will flash.

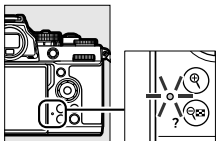

- If the display is turned on by pressing the shutter-release button halfway, the message [**Interval timer shooting**] will be displayed and the  icon will flash.



■ Pausing interval-timer photography

Interval-timer photography can be paused between intervals by pressing **OK** or by selecting **[Interval timer shooting]** in the photo shooting menu, highlighting **[Pause]**, and pressing **OK**. Note that the menus may not be displayed when the **MENU** button is pressed if the time selected for **[Interval]** is very short.

- If **[Time-lapse video]** is selected for **[Options]**, pressing **OK** between intervals will end interval-timer photography.

■ Resuming interval timer shooting

Interval timer shooting can be resumed as described below.

- **To resume shooting immediately:**

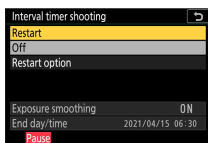

Highlight **[Restart]** and press **OK**.

- **To resume shooting at a specified time:**

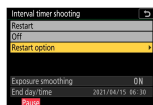

Select **[Restart option]**, highlight **[Choose day/time]** and press **OK**.

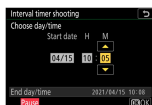

Choose a starting date and time and press **OK**.

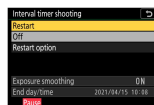

Highlight **[Restart]** and press **OK**.

■ ■ Ending interval timer shooting

To end interval-timer photography before all the photos are taken, select [**Interval timer shooting**] in the photo shooting menu, highlight [**Off**], and press \odot . Note that the menus may not be displayed when the MENU button is pressed if the time selected for [**Interval**] is very short. In this case you will need to press \odot to pause interval-timer photography and then select [**Interval timer shooting**] in the photo shooting menu, highlight [**Off**], and press \odot .

✔ Interval-timer photography

- Choose an interval longer than the time needed to take the selected number of shots at the predicted shutter speed. Note that during actual interval-timer photography, the camera must not only take shots at the selected interval but must also have sufficient time to complete the exposures and perform such tasks as processing the photographs. If the interval is too short to take the selected number of photos, the camera may skip to the next interval without shooting.
- If the interval is too short, the total number of shots taken may be less than that selected for $[\text{Intervals} \times \text{shots} / \text{interval}]$.
- If you are using a flash, choose an interval longer than the time needed for the flash to charge. If the interval is too short, the flash may fire at less than the power needed for full exposure.
- If shooting cannot proceed at current settings—for example, if shutter speed is set to “**Bulb**” or “**Time**”, the [Interval] is [00:00'00"], or the start time is in less than a minute—a warning will be displayed in the monitor.
- Interval-timer photography will not start if [On] is selected for both [Silent photography] and [Interval priority] and [00:00'0.5"] is selected for [Interval].
- If [On] is selected for [Silent photography] or [Time-lapse video] is selected for [Options], the standby timer will not expire during interval-timer photography, regardless of the option selected for Custom Setting c3 [Power off delay] > [Standby timer].
- If the memory card is full, the interval timer will remain active but no pictures will be taken. Insert another memory card and resume shooting (□306).
- Interval timer shooting will pause if:
 - The camera is turned off and then on again (when the camera is off, batteries and memory cards can be replaced without ending interval-timer photography)
 - ☺ is selected for release mode
- Changing camera settings while the interval timer is active may cause shooting to end.

✔ **Release mode**

Regardless of the release mode selected, the camera will take the specified number of shots at each interval.

✔ **Adjusting settings between shots**

Pictures can be viewed and shooting and menu settings adjusted between shots. Note, however, that the monitor will turn off and shooting will resume a few seconds before the next shot is taken.

✔ **Interval-timer photography: Restrictions**

Interval-timer photography cannot be combined with some camera features, including:

- video recording,
- long time-exposures (“Bulb” or “Time”),
- the self-timer,
- bracketing,
- HDR (high dynamic range),
- multiple exposures, and
- focus shift

✔ **When [On] is selected for [Silent photography]**

Selecting [On] for [Silent photography] disables some camera features, including:

- ISO sensitivities of Hi 1 and Hi 2,
- flash photography,
- long-exposure noise reduction, and
- flicker reduction.

✔ **Interval timer settings**

Turning the camera off or selecting a new release mode does not affect interval-timer photography settings.

Time-lapse video

MENU button ➔  photo shooting menu

The camera automatically takes photos at selected intervals to create a time-lapse video.

Option	Description
[Start]	Start time-lapse recording. Shooting starts after about 3 s and continues at the interval selected for [Interval] for the time selected for [Shooting time].
[Interval]	Choose the interval between shots, in minutes and seconds.
[Shooting time]	Choose how long the camera will continue to take pictures, in hours and minutes.
[Exposure smoothing]	Selecting [On] smooths abrupt changes in exposure. <ul style="list-style-type: none">• Large changes in subject brightness during shooting may result in apparent variations in exposure. This can be addressed by shortening the interval between shots.• Exposure smoothing will not take effect in mode M if [Off] is selected for [ISO sensitivity settings] > [Auto ISO sensitivity control] in the photo shooting menu.
[Silent photography]	Select [On] to silence the shutter and eliminate the vibrations it produces during shooting. <ul style="list-style-type: none">• Selecting [On] does not completely silence the camera. Camera sounds may still be audible, for example during autofocus or aperture adjustment, in the latter case most noticeably at apertures smaller (i.e., at f-numbers higher) than f/5.6.
[Frame size/ frame rate]	Choose the frame size and rate for the final video.

Option	Description
[Interval priority]	<ul style="list-style-type: none"> • [On]: Enable interval priority to ensure that frames shot in modes P and A are taken at the chosen interval. <ul style="list-style-type: none"> - Select [Release] for Custom Setting a2 [AF-S priority selection] when AF-S is selected for focus mode and for Custom Setting a1 [AF-C priority selection] when AF-C is selected. - If [On] is selected for [ISO sensitivity settings] > [Auto ISO sensitivity control] and the time chosen for [Minimum shutter speed] is longer than the interval, the time selected for the interval will take priority over the selected shutter speed. • [Off]: Disable interval priority to ensure that photos are correctly exposed.
[Focus before each shot]	If [On] is selected, the camera will focus between shots.

Recording time-lapse videos

✓ Before shooting

- Time-lapse videos are shot using the video crop.
- Take test shots and check the results in the monitor.
- Before proceeding, select [Time zone and date] in the setup menu and make sure that the camera clock is set to the correct time and date.
- To ensure that shooting is not interrupted, use a fully-charged battery or an optional charging AC adapter.

1 Highlight [Time-lapse video] in the photo shooting menu.

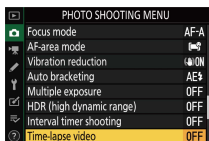

Press **[OK]** to select the highlighted item and view the **[Time-lapse video]** menu.

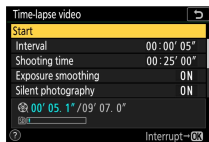

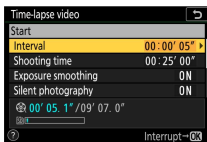

2 Adjust time-lapse video settings.

- Choose the interval between shots.

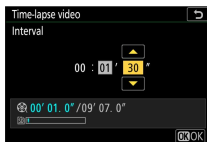

Highlight [**Interval**] and press .



Choose an interval (in minutes and seconds) and press .

- Choose an interval longer than the slowest anticipated shutter speed.

- Choose the total shooting time.

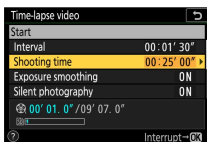

Highlight [**Shooting time**] and press .

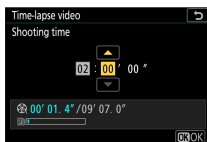

Choose a shooting time (in hours and minutes) and press .

- The maximum shooting time is 7 hours and 59 minutes.

• **Enable or disable exposure smoothing.**

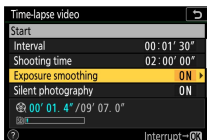

Highlight [**Exposure smoothing**] and press .

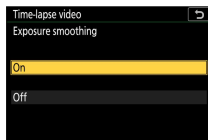

Highlight an option and press .

- Selecting [**On**] smooths abrupt changes in exposure.

• **Enable or disable silent photography.**

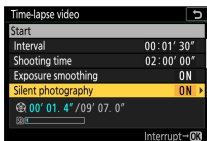

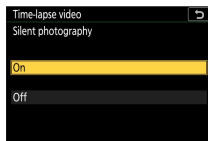

Highlight [**Silent photography**] and press .



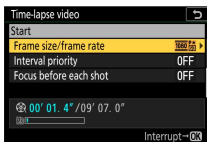

Highlight an option and press .

• **Choose the frame size and rate.**



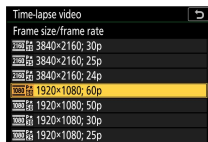

Highlight [**Frame size/frame rate**] and press .



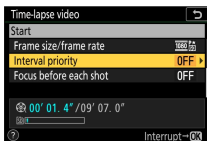

Highlight an option and press .

• **Choose an interval priority option.**



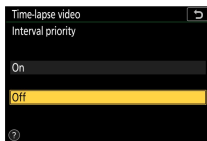

Highlight [**Interval priority**] and press .



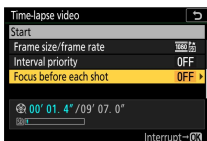

Highlight an option and press .

• **Choose whether the camera focuses between shots.**

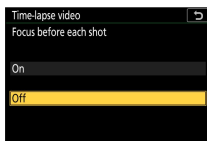

Highlight [**Focus before each shot**] and press .



Highlight an option and press .

- If [**On**] is selected for [**Focus before each shot**], the camera will focus before each shot according to the option currently selected for focus mode.

3 Highlight [Start] and press \odot .

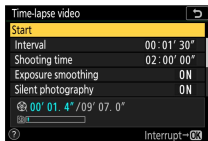

- Shooting starts after about 3 s.
- The display turns off during shooting.
- The camera takes pictures at interval selected for **[Interval]** for the time selected for **[Shooting time]** in Step 2.

Ending shooting

To end shooting before all the photos are taken, press \odot or select **[Time-lapse video]** in the photo shooting menu, highlight **[Off]**, and press \odot .

Note that the menus may not be displayed when the **MENU** button is pressed if the time selected for **[Interval]** is very short.

- A video will be created from the frames shot to the point where shooting ended and normal photography will resume.

✓ Calculating the length of the final video

- The total number of frames in the final video can be calculated by dividing the shooting time selected in Step 2 by the interval, rounding up, and adding 1.
- The length of the final video can then be calculated by dividing the number of shots by the frame rate selected for **[Frame size/frame rate]** (for example, a 48-frame video recorded with **[1920×1080; 24p]** selected for **[Frame size/frame rate]** will be about two seconds long).
- The maximum length for time-lapse videos is 20 minutes.

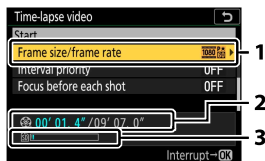

1 Frame size/frame rate

2 Length recorded/maximum length



3 Memory card indicator

✓ Picture review

The  button cannot be used to view pictures while shooting is in progress. The current frame will however be displayed for a few seconds after each shot if **[On]** or **[On (monitor only)]** is selected for **[Picture review]** in the playback menu. Note that other playback operations cannot be performed while the frame is displayed. The current frame may not be displayed if the interval is very short.

✓ Time-lapse videos

- Sound is not recorded with time-lapse videos.
- The shutter speed and the time needed to record the image to the memory card may vary from shot to shot. As a result, the interval between a shot being recorded and the start of the next shot may vary.
- Shooting will not begin if a time-lapse video cannot be recorded at current settings, for example if:

- The value selected for [Interval] is longer than that selected for [Shooting time]
- [00:00'00"] is selected for [Interval] or [Shooting time]
- [On] is selected for both [Silent photography] and [Interval priority] and [00:00'0.5"] is selected for [Interval]
- The memory card is full
- If time-lapse video recording cannot start at current settings, for example because shutter speed is set to "Bulb" or "Time", a warning will be displayed.
- The  button cannot be used to view pictures while time-lapse recording is in progress.
- For consistent coloration, choose a white balance setting other than  **A** [Auto] or  **A** [Natural light auto] when recording time-lapse videos.
- Regardless of the option selected for Custom Setting c3 [Power off delay] > [Standby timer], the standby timer will not expire while recording is in progress.
- Shooting may end if camera controls are used, settings are changed, or an HDMI cable is connected. A video will be created from the frames shot to the point where shooting ended.
- The following end shooting without a beep sounding or a video being recorded:
 - Removing the battery
 - Ejecting the memory card

During shooting

The memory card access lamp lights while shooting is in progress.

Settings between recordings

Shooting and menu settings can be adjusted between time-lapse video recordings. Note, however, that the monitor will turn off and shooting will resume in about 2 seconds before the next shot is taken.

Time-lapse videos: Restrictions

Time-lapse video recording cannot be combined with some camera features, including:

- video recording,
- long time-exposures (“Bulb” or “Time”),
- the self-timer,
- bracketing,
- HDR (high dynamic range),
- multiple exposures,
- interval-timer photography, and
- focus shift.

✔ When [On] is selected for [Silent photography]

Selecting [On] for [Silent photography] disables some camera features, including:

- ISO sensitivities of Hi 1 and Hi 2,
- flash photography,
- exposure delay mode,
- long-exposure noise reduction, and
- flicker reduction.

Focus shift shooting

MENU button ➡ 📷 photo shooting menu

Focus shift automatically varies focus over a series of shots. Use it to take photos that will later be combined using focus stacking to create a single image with increased depth of field. Before using focus shift, choose a focus mode of **AF-A**, **AF-S**, or **AF-C** and a release mode other than ☺.

Option	Description
[Start]	Start shooting. The camera will take the selected number of shots, changing the focus distance by the selected amount with each shot.
[No. of shots]	Choose the number of shots (maximum 300).

Option	Description
[Focus step width]	Focus shift varies the focus distance over a series of photographs. Choose the amount the focus distance changes with each shot.
[Interval until next shot]	<p>Choose the interval between shots, in seconds.</p> <ul style="list-style-type: none"> • Select [00] to take photos at up to about 3 fps. • To ensure correct exposure when using a flash, choose an interval long enough for the flash to charge.
[First-frame exposure lock]	<ul style="list-style-type: none"> • [On]: The camera locks exposure for all shots at the setting for the first frame. • [Off]: The camera adjusts exposure before each shot.
[Silent photography]	<p>Select [On] to eliminate shutter sounds during shooting.</p> <ul style="list-style-type: none"> • Selecting [On] does not completely silence the camera. Camera sounds may still be audible, for example during autofocus or aperture adjustment, in the latter case most noticeably at apertures smaller (i.e., at f-numbers higher) than f/5.6.
[Starting storage folder]	<p>Highlight an option and press  to select (<input checked="" type="checkbox"/>) or deselect (<input type="checkbox"/>)</p> <ul style="list-style-type: none"> • [New folder]: A new folder is created for each new sequence. • [Reset file numbering]: File numbering is reset to 0001 whenever a new folder is created.

Focus shift photography

✓ Before shooting

- Take a test shot at current settings.
- To ensure that shooting is not interrupted, use a fully-charged battery or an optional charging AC adapter.

1 Focus.

- During focus shift, the camera takes a series of shots starting from a selected focus position and continuing toward infinity. Given that shooting ends when infinity is reached, the starting focus position should be slightly in front of (i.e., closer to the camera than) the closest point on the subject.
- Do not move the camera after focusing.

2 Highlight [Focus shift shooting] in the photo shooting menu.

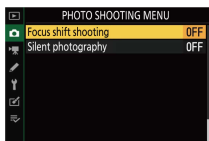

Press  to select the highlighted item and display focus shift settings.



3 Adjust focus shift settings.

• Choose the number of shots.



Highlight [**No. of shots**] and press

Choose the number of shots and press

- The maximum number of shots is 300.
- We recommend taking more shots than you think you'll need. You can winnow them down during focus stacking.
- More than 100 shots may be required for photographs of insects or other small objects. On the other hand, only a few may be needed to photograph a landscape from front to back with a wide-angle lens.

• Choose the amount the focus distance changes with each shot.

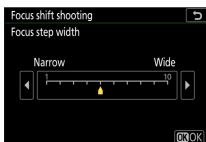



Highlight [**Focus step width**] and press

Choose a focus step width and press

- Press to reduce the focus step width, to increase.
- Note that high settings increase the risk that some areas will be out of focus when the shots are stacked. A value of 5 or less is recommended.
- Try experimenting with different settings before shooting.

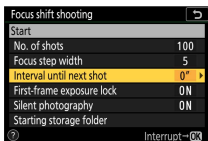
• **Choose the interval until next shot.**



Highlight [**Interval until next shot**] and press .

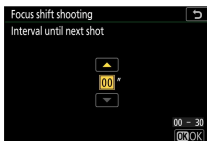

Choose the interval between shots and press .

- Choose the interval between shots, in seconds.
- Select [**00**] to take photos at up to about 3 fps.
- To ensure correct exposure when using a flash, choose an interval long enough for the flash to charge. A setting of [**00**] is recommended when shooting without a flash.

• **Enable or disable first-frame exposure lock.**

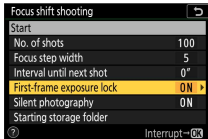

Highlight [**First-frame exposure lock**] and press .

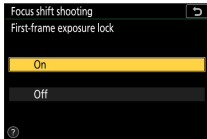

Highlight an option and press .

- [**Off**] is recommended if lighting and other conditions will not change during shooting, [**On**] when photographing landscapes and the like under variable lighting.
- Selecting [**On**] locks exposure at the value for the first shot, ensuring that all photos have the same exposure. Large changes in subject brightness during shooting may however result in

apparent variations in exposure. This can be addressed by selecting [**Off**].

• **Enable or disable silent photography.**

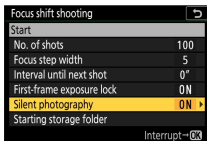

Highlight [**Silent photography**] and press

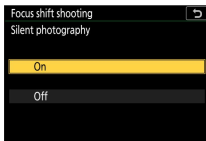



Highlight an option and press .

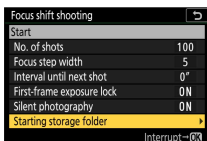

• **Choose starting folder options.**

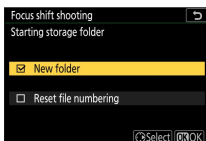

Highlight [**Starting storage folder**] and press



Select the desired options and press  to proceed.

- Highlight an option and press  to select; selected items are marked with a check (). To deselect (remove the check from:) a selected option, highlight it and press  again.
- Place a check () next to [**New folder**] to create a new folder for each new sequence.
- Place a check () next to [**Reset file numbering**] to reset file numbering to 0001 whenever a new folder is created.

4 Highlight [Start] and press **OK**.



- Shooting starts after about 3 s.
- The display turns off during shooting.
- The camera takes photographs at the selected interval, starting at the focus distance selected at the start of shooting and progressing out toward infinity by the selected focus step distance with each shot.
- Shooting ends when the selected number of shots has been taken or focus reaches infinity.

Ending focus shift photography

To end shooting before all shots have been taken, either:

- select [**Focus shift shooting**] in the photo shooting menu, highlight [**Off**], and press **OK**, or
- press the shutter-release button halfway or press the **OK** button between shots.

✔ Aperture

Given that pictures shot at very small apertures (high f-numbers) may lack definition, we recommend that you choose apertures wider (f-numbers lower) than f/8–f/11.

✔ During shooting

The memory card access lamp flashes while shooting is in progress.

✔ Focus shift photography

- The shutter speed and the time needed to record the image may vary from shot to shot. As a result, the interval between a shot being recorded and the start of the next shot may vary.
- Shooting ends when focus reaches infinity, and consequently depending on the focus position at the start of shooting, shooting may end before the selected number of shots has been taken.
- Regardless of the option selected for Custom Setting c3 [**Power off delay**] > [**Standby timer**], the standby timer will not expire while shooting is in progress.
- If you are using a flash, choose an interval longer than the time needed for the flash to charge. If the interval is too short, the flash may fire at less than the power needed for full exposure.
- If shooting cannot proceed at current settings, for example because shutter speed is set to “**Bulb**” or “**Time**”, a warning will be displayed.
- Changing camera settings while focus shift photography is in progress may cause shooting to end.

✔ Focus shift photography: Restrictions

Focus-shift photography cannot be combined with some camera features, including:

- video recording,
- long time-exposures (“**Bulb**” or “**Time**”),
- the self-timer,
- bracketing,
- HDR (high dynamic range),
- multiple exposures,

- interval-timer photography, and
- time-lapse video recording.

✔ **When [On] is selected for [Silent photography]**

Selecting **[On]** for **[Silent photography]** disables some camera features, including:

- ISO sensitivities of Hi 1 and Hi 2,
- flash photography,
- exposure delay mode,
- long-exposure noise reduction, and
- flicker reduction.

✔ **Close-ups**

Because focus depth is reduced at short focus distances, we recommend choosing smaller focus steps and increasing the number of shots when photographing subjects close to the camera.

Silent photography

MENU button ➡  photo shooting menu

Eliminate shutter sounds during shooting (☞121).

Option	Description
[On]	<p>Eliminate vibrations produced by the shutter. Use for landscapes, still lifes, and other static subjects. Use of a tripod is recommended.</p> <ul style="list-style-type: none"> • Selecting [On] for [Silent photography] does not completely silence the camera. Camera sounds may still be audible, for example during autofocus or aperture adjustment, in the latter case most noticeably at apertures smaller (i.e., at f-numbers higher) than f/5.6. • Flash photography is disabled. • Long-exposure noise reduction is disabled. • The electronic shutter is used, regardless of the option selected for Custom Setting d4 [Shutter type]. • Regardless of the settings selected for [Beep options] in the setup menu, beeps will not sound when the camera focuses or while the self-timer is in operation. • Enabling silent photography changes the frame advance rates for continuous release modes (□168).
[Off]	Disable silent photography.

The video recording menu: Video recording options

To view the video recording menu, select the  tab in the camera menus.



The video recording menu contains the following items:

Item		Item	
[Reset video recording menu]	330	[Diffraction compensation]	334
[File naming]	330	[Auto distortion control]	334
[Frame size/frame rate]	330	[Flicker reduction]	334
[Video quality]	330	[Metering]	335
[Video file type]	331	[Release mode (save frame)]	335
[ISO sensitivity settings]	331	[Focus mode]	336
[White balance]	332	[AF-area mode]	336
[Set Picture Control]	333	[Vibration reduction]	336
[Manage Picture Control]	333	[Electronic VR]	337
[Active D-Lighting]	333	[Microphone sensitivity]	337
[High ISO NR]	334	[Attenuator]	338
[Vignette control]	334	[Frequency response]	338

Item	
[Wind noise reduction]	339

Item	
[Timecode]	339

See also



“Video recording menu defaults” ([□□220](#))

Reset video recording menu

MENU button   video recording menu



Highlight [**Yes**] and press  to restore video recording menu options to their default values ([□□220](#)).

File naming

MENU button   video recording menu



Choose the three-letter prefix used in naming the image files in which videos are stored; the default prefix is “DSC” ([□□242](#)).

Frame size/frame rate

MENU button   video recording menu

Choose the video frame size (in pixels) and frame rate. For more information, see “Frame size and rate/Video quality” in “The  menu” ([□□175](#)).

Video quality

MENU button   video recording menu

Choose from [**High quality**] and [**Normal**]. For more information, see “Frame size and rate/Video quality” in “The  menu” ([□□175](#)).

Video file type

MENU button ➡  video recording menu

Record videos in MOV or MP4 format.

- The audio recording format varies with video file format. Linear PCM is used for MOV files and AAC for MP4 files.

ISO sensitivity settings

MENU button ➡  video recording menu

Adjust the ISO sensitivity settings for video mode.

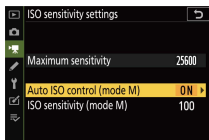

Option	Description
[Maximum sensitivity]	Choose the upper limit for auto ISO sensitivity control to prevent it being raised too high. <ul style="list-style-type: none">• The selected value serves as the upper limit for ISO sensitivity in modes P, S, and A and when [On] is selected for [Auto ISO control (mode M)] in mode M.
[Auto ISO control (mode M)]	If you select [On] and press the  button, the camera will automatically adjust the ISO sensitivity for video mode in mode M . If [Off] is selected, the ISO sensitivity will remain fixed at the value selected with the ISO sensitivity dial. <ul style="list-style-type: none">• Regardless of the option selected, auto ISO sensitivity control is used in modes other than M.

Option	Description
[ISO sensitivity (mode M)]	The ISO sensitivity selected with the ISO sensitivity dial is displayed.

- When auto ISO sensitivity control is enabled, the shooting display will show **ISO AUTO**. When sensitivity is altered from the value selected by the user, the ISO sensitivity will be shown in the displays.



✓ Auto ISO sensitivity control

- At high ISO sensitivities, “noise” (randomly-spaced bright pixels, fog, or lines) may increase.
- At high ISO sensitivities, the camera may have difficulty focusing.
- The foregoing can be prevented by choosing a lower value for [ISO sensitivity settings] > [Maximum sensitivity].

White balance

MENU button ➡ video recording menu

Choose the white balance for videos. Select [**Same as photo settings**] to use the option currently selected for photos (□248).

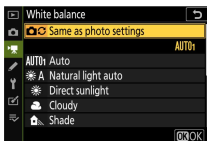

Set Picture Control

MENU button ➡ ❶ video recording menu

Choose a Picture Control for videos. Select [**Same as photo settings**] to use the option currently selected for photos (☞255).

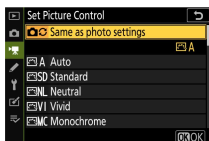

Manage Picture Control

MENU button ➡ ❶ video recording menu

Save modified Picture Controls as custom Picture Controls (☞257).

Active D-Lighting

MENU button ➡ ❶ video recording menu

Preserve details in highlights and shadows, creating videos with natural contrast. Select [**Same as photo settings**] to use the option currently selected for photos (☞164, ☞181).

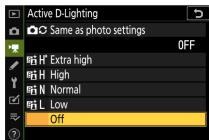

High ISO NR

MENU button ➡  video recording menu

Reduce “noise” (randomly-spaced bright pixels) in videos recorded at high ISO sensitivities (□□263).

Vignette control

MENU button ➡  video recording menu

Reduce vignetting in videos. Select [**Same as photo settings**] to use the option currently selected for photos (□□264).

Diffraction compensation

MENU button ➡  video recording menu

Reduce diffraction in videos (□□264).

Auto distortion control

MENU button ➡  video recording menu

Reduce barrel and pin-cushion distortion in videos (□□265).

Flicker reduction

MENU button ➡  video recording menu

Reduce flicker and banding when shooting under fluorescent or mercury-vapor lighting during video recording. Choose [**Auto**] to allow the camera to automatically choose the correct frequency. If [**Auto**] fails to produce the desired results, select [**50 Hz**] or [**60 Hz**] according to the frequency of the local power supply. Choose [**50 Hz**] for areas with a 50 Hz power supply, [**60 Hz**] for areas with a 60 Hz power supply.

✔ Flicker reduction in the video recording menu

- If [**Auto**] fails to produce the desired results and you are unsure as to the frequency of the local power supply, test both the 50 and 60 Hz options and choose the one that produces the best results.
- Flicker reduction may not produce the desired results if the subject is very bright. If this is the case, try choosing a smaller aperture (higher f-number).
- Flicker reduction may not produce the desired results in modes other than **M**. If this is the case, select mode **M** and choose a shutter speed adapted to the frequency of the local power supply:
 - 50Hz: 1/100 s, 1/50 s, 1/25 s
 - 60Hz: 1/125 s, 1/60 s, 1/30 s

Metering

MENU button ➡  video recording menu

Choose how the camera meters exposure in video mode. [**Spot metering**] is not available in the video recording menu (□162).

Release mode (save frame)

MENU button ➡  video recording menu

In video mode, you can choose the operation performed when the shutter-release button is pressed (□92).

Option	Description
[S] [Single frame]	The camera takes one photograph each time the shutter-release button is pressed. Up to 40 photographs can be taken with each video.

Option	Description
 [Continuous]	<ul style="list-style-type: none"> • The camera takes photos while the shutter-release button is pressed. • The frame advance rate varies with the frame rate selected for [Frame size/frame rate] in the video recording menu. • The length of time available for the burst is shown in the shooting display. • While video recording is in progress, only one photo will be taken each time the shutter-release button is pressed.

Focus mode

MENU button ➡  video recording menu

Choose a focus mode for video recording (□100).

AF-area mode

MENU button ➡  video recording menu

Choose how the camera focuses in video mode (□102).

Vibration reduction

MENU button ➡  video recording menu

Adjust vibration reduction settings for video mode. Select [**Same as photo settings**] to use the option currently selected for photos (□171).

Electronic VR

MENU button ➡  video recording menu

Choose whether to enable electronic vibration reduction in video mode (181).

Microphone sensitivity

MENU button ➡  video recording menu

Turn built-in or external microphones on or off or adjust microphone sensitivity.

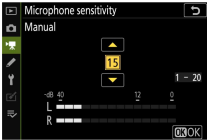
Option	Description
[Auto]	Adjust microphone sensitivity automatically.
[Manual]	<p>Adjust microphone sensitivity manually. Choose from values of from [1] to [20]. The higher the value, the higher the sensitivity; the lower the value, the lower the sensitivity.</p> 
[Microphone off]	Turn sound recording off.

✔ Videos without sound

Videos recorded with [**Microphone off**] selected for [**Microphone sensitivity**] are indicated by a  icon.

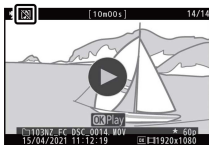

Attenuator



MENU button ➡  video recording menu

Select [**Enable**] to reduce microphone gain and prevent audio distortion when recording videos in loud environments.

Frequency response

MENU button ➡  video recording menu

Choose the range of frequencies to which built-in and external microphones respond.

	Option	Description
	[Wide range]	Record a wide range of frequencies. Choose for everything from music to the bustling hum of a city street.
	[Vocal range]	Choose for human voices.

Wind noise reduction

MENU button ➡  video recording menu

Choose whether to use wind noise reduction when recording videos. For more information about wind noise reduction, see “Wind noise reduction” in “The  menu” (p.179).

Timecode

MENU button ➡  video recording menu

Choose whether to record time codes giving the hour, minute, second, and frame number for each frame when recording videos. Time codes are available only with videos recorded in MOV format.

Option	Description
[Record timecodes]	<ul style="list-style-type: none">• [On]: Record time codes. The time code appears in the shooting display.• [On (with HDMI output)]: Time codes will be included with footage saved to external recorders connected to the camera via an HDMI cable. The camera supports Atomos SHOGUN, NINJA, and SUMO-series Monitor recorders.• [Off]: Time codes are not recorded.
[Count-up method]	<ul style="list-style-type: none">• [Record run]: Time codes are incremented only while recording is in progress.• [Free run]: Time codes are incremented continuously. Time codes continue to be incremented while the camera is off.

Option	Description
[Timecode origin]	<ul style="list-style-type: none"> • [Reset]: Reset the time code to 00:00:00.00. • [Enter manually]: Enter the hour, minute, second, and frame number manually. • [Current time]: Set the time code to the current time as reported by the camera clock. Before proceeding, select [Time zone and date] in the setup menu and make sure that the camera clock is set to the correct time and date.
[Drop frame]	Select [On] to compensate for discrepancies between the frame count and the actual recording time at frame rates of 30 and 60 fps.

✓ HDMI devices

Selecting [On (with HDMI output)] for [Record timecodes] may disrupt footage output to HDMI devices.

Custom Settings: Fine-tuning camera settings

To view Custom Settings, select the  tab in the camera menus.

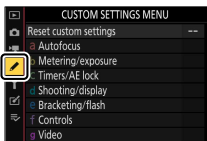

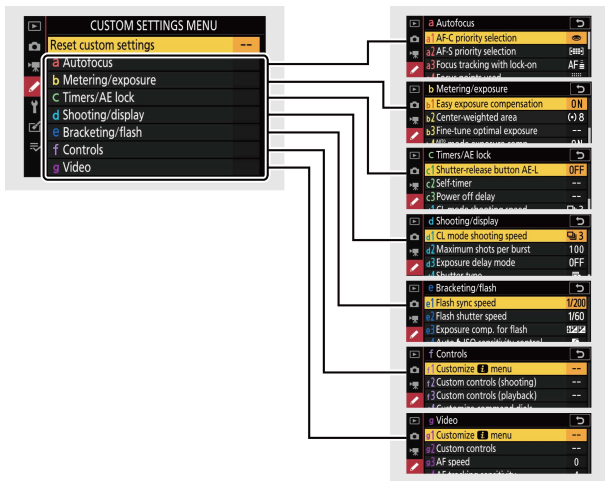

Custom Settings are used to customize camera settings to suit individual preferences. The Custom Settings menu is divided into two levels.



The following Custom Settings are available: 1

Item		☰	Item		☰
[Reset custom settings]		343	b2	[Center-weighted area]	353
a [Autofocus]			b3	[Fine-tune optimal exposure]	353
a1	[AF-C priority selection]	344	b4	[ mode exposure comp.]	354
a2	[AF-S priority selection]	344	c [Timers/AE lock]		
a3	[Focus tracking with lock-on]	345	c1	[Shutter-release button AE-L]	354
a4	[Focus points used]	345	c2	[Self-timer]	355
a5	[Store points by orientation]	346	c3	[Power off delay]	355
a6	[AF activation]	348	d [Shooting/display]		
a7	[Limit AF-area mode selection]	349	d1	[CL mode shooting speed]	356
a8	[Focus point wrap-around]	349	d2	[Maximum shots per burst]	356
a9	[Focus point options]	350	d3	[Exposure delay mode]	356
a10	[Low-light AF]	350	d4	[Shutter type]	357
a11	[Built-in AF-assist illuminator]	351	d5	[Extended shutter speeds (M)]	357
a12	[Manual focus ring in AF mode] 2	352	d6	[File number sequence]	358
b [Metering/exposure]			d7	[Apply settings to live view]	359
b1	[Easy exposure compensation]	352	d8	[Framing grid display]	360

Item		📖
d9	[Focus peaking]	360
d10	[View all in continuous mode]	361
e [Bracketing/flash]		
e1	[Flash sync speed]	361
e2	[Flash shutter speed]	362
e3	[Exposure comp. for flash]	363
e4	[Auto  ISO sensitivity control]	363
e5	[Auto bracketing (mode M)]	364
e6	[Bracketing order]	365
f [Controls]		
f1	[Customize  menu]	365

Item		📖
f2	[Custom controls (shooting)]	367
f3	[Custom controls (playback)]	375
f4	[Customize command dials]	377
f5	[Release button to use dial]	380
f6	[Reverse indicators]	381
g [Video]		
g1	[Customize  menu]	381
g2	[Custom controls]	382
g3	[AF speed]	388
g4	[AF tracking sensitivity]	389
g5	[Highlight display]	389

- 1 Items modified from default values are indicated by asterisks ("*").
- 2 Available with compatible lenses only.

✔ See also

"Custom Settings menu defaults" (📖222)

Reset custom settings

MENU button ➡  Custom Settings menu



Restore Custom Settings to their default values.

a: Autofocus

a1: AF-C priority selection

MENU button ➔  Custom Settings menu



Choose whether photos can be taken before the camera focuses when **AF-C** is selected.

Option	Description
 [Release]	Photos can be taken whenever the shutter-release button is pressed (release priority).
 [Focus]	Photos can be taken only when the camera is in focus (focus priority).

a2: AF-S priority selection

MENU button ➔  Custom Settings menu

Choose whether photos can be taken before the camera focuses when **AF-S** is selected.

Option	Description
 [Release]	Photos can be taken whenever the shutter-release button is pressed (release priority).
 [Focus]	Photos can be taken only when the camera is in focus (focus priority).

a3: Focus tracking with lock-on

MENU button ➔  Custom Settings menu

Choose how quickly focus responds if something passes between the subject and the camera when **AF-C** is selected for focus mode or when **AF-A** is selected and you are shooting in **AF-C**.

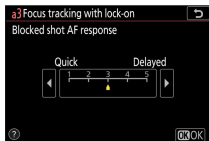



- Choose [**5 (Delayed)**] to help maintain focus on your original subject.
- Choose [**1 (Quick)**] to make it easier to shift focus to objects crossing your field of view.
- If [**Auto-area AF**], [**Auto-area AF (people)**], or [**Auto-area AF (animals)**] is selected for AF-area mode, blocked shot AF response will function in mode [**3**] when [**2**] or [**1 (Quick)**] is selected.

a4: Focus points used

MENU button ➔  Custom Settings menu

Choose the number of focus points available for manual focus-point selection when an option other than [**Auto-area AF**], [**Auto-area AF (people)**], or [**Auto-area AF (animals)**] is selected for AF-area mode.

Option	Description
 [All points]	Every focus point available in the current AF-area mode can be selected. The number of points available varies with the AF-area mode.

Option	Description
 [Alternating points]	The number of available focus points is reduced to one quarter of the number available when [All points] is selected. Use for quick focus-point selection. The number of focus points available in [Pinpoint AF] , [Wide-area AF (L)] , [Wide-area AF (L-people)] , or [Wide-area AF (L-animals)] mode does not change.

a5: Store points by orientation

MENU button ➡  Custom Settings menu

Choose whether separate focus points can be selected for “wide” (landscape) orientation, for “tall” (portrait) orientation with the camera rotated 90° clockwise, and for “tall” orientation with the camera rotated 90° counterclockwise.

- Select **[No]** to use the same focus point regardless of camera orientation.

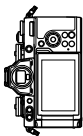

Camera rotated 90°
counter-clockwise



Landscape (wide)
orientation



Camera rotated 90°
clockwise

- Select **[Yes]** to enable separate focus-point selection.

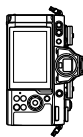
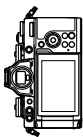

Camera rotated 90°
counter-clockwise



Landscape (wide)
orientation



Camera rotated 90°
clockwise

a6: AF activation

MENU button → Custom Settings menu

Choose whether the shutter-release button can be used to focus. If **[AF-ON only]** is selected, the camera will not focus when the shutter-release button is pressed halfway. Focus can only be adjusted using other controls to which AF-ON has been assigned using Custom Setting f2 **[Custom controls (shooting)]**.

Out-of-focus release

To choose whether the shutter can be released even in circumstances in which it would normally be disabled, select Custom Setting a6 **[AF activation]**, highlight **[AF-ON only]**, and press . Selecting **[Enable]** allows the shutter to be released at any time.

Option	Description
[Enable]	Shutter-release enabled.
[Disable]	Shutter-release disabled.

a7: Limit AF-area mode selection

MENU button ➔  Custom Settings menu

Choose the AF-area modes that can be selected using the **i** menu or custom controls.

- Highlight an option and press **⏎** to select () or deselect (). Modes marked with a check () are available for selection via the sub-command dial.

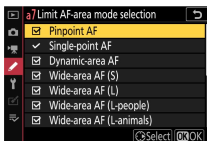

- To complete the operation, press **⏎**.

a8: Focus point wrap-around

MENU button ➔  Custom Settings menu

Choose whether focus-point selection “wraps around” from one edge of the display to another. If **[Wrap]** is selected, focus-point selection will “wrap around” from top to bottom, bottom to top, right to left, and left to right, so that, for example, pressing multi selector **⏎** when a focus point at the right edge of the viewfinder display is highlighted selects the corresponding focus point at the left edge of the display.

a9: Focus point options

MENU button ➡  Custom Settings menu

Choose from the focus point display options below.

Manual focus mode

Option	Description
[On]	The focus point is displayed at all times in manual focus mode.
[Off]	The focus point is displayed only during focus point selection.

Dynamic-area AF assist

Choose whether both the selected focus point and the surrounding focus points are displayed in dynamic-area AF mode.

Option	Description
[On]	Display both the selected focus point and surrounding focus points.
[Off]	Display only the selected focus point.

a10: Low-light AF

MENU button ➡  Custom Settings menu

Choose **[On]** for more accurate focus under low-light conditions when **AF-S** is selected for focus mode or when **AF-A** is selected and you are shooting in **AF-S**.

- This option only takes effect in photo mode.
- In  mode, **[Low-light AF]** is fixed at **[On]**.
- Low-light AF is disabled during interval-timer photography and time-lapse video recording.
- The camera may require more time to focus when **[On]** is selected.

- While low-light AF is in effect, “Low-light” will appear in the display. The display refresh rate may drop.

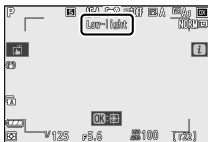

a11: Built-in AF-assist illuminator

MENU button ➔ Custom Settings menu

Choose whether the built-in AF-assist illuminator lights to assist the focus operation in photo mode when lighting is poor.

Option	Description
[On]	In photo mode, the illuminator will light as required when AF-S is selected for focus mode or when AF-A is selected and you are shooting in AF-S .
[Off]	The illuminator does not light to assist the focus operation. The camera may not be able to focus when lighting is poor.

✓ The AF-assist illuminator

- The AF-assist illuminator has a range of about 1–3 m (3 ft 4 in.–9 ft 10 in.).
- Remove lens hoods when using the illuminator.
- Do not obstruct the AF-assist illuminator while it is lit.

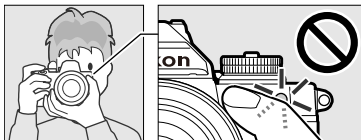

a12: Manual focus ring in AF mode

MENU button ➔  Custom Settings menu

Choose whether the lens focus ring can be used for manual focus in autofocus mode.

Option	Description
[Enable]	Autofocus can be over-ridden by rotating the lens focus ring (autofocus with manual override). The focus ring can be used for manual focus while the shutter-release button is pressed halfway. To refocus using autofocus, lift your finger from the shutter-release button and then press it halfway again.
[Disable]	The lens focus ring cannot be used for manual focus while autofocus mode is selected.

b: Metering/exposure

b1: Easy exposure compensation

MENU button ➔  Custom Settings menu

Choose whether exposure compensation can be performed with the command dial when the exposure compensation dial is set to [C].

Option	Description
[On (Auto reset)]	Exposure compensation can be adjusted using a command dial. The setting selected with the command dial is reset when the camera turns off or the standby timer expires.
[On]	Exposure compensation can be adjusted using a command dial. Exposure compensation is not reset when the camera turns off or the standby timer expires.

Option	Description
[Off]	Set the exposure compensation with the exposure compensation dial.

- Enabled in modes **P**, **S**, **A**, and **Ⓜ**. In mode **Ⓜ**, set Custom Setting b4 [**Ⓜ mode exposure comp.**] to [**Enable**]. Easy exposure compensation is not available in other modes.
- The command dial used varies with the shooting mode.

b2: Center-weighted area

MENU button →  Custom Settings menu

When [**Center-weighted metering**] is selected, the camera assigns the greatest weight to an area in the center of the shooting display when setting exposure. Custom Setting b2 [**Center-weighted area**] is used to choose the size of the area given the greatest weight when [**Center-weighted metering**] is selected.

b3: Fine-tune optimal exposure

MENU button →  Custom Settings menu

Use this option to fine-tune the exposure value selected by the camera; exposure can be fine-tuned separately for each metering method. Exposure can be adjusted up for brighter exposures or down for darker exposures in the range +1 to -1 EV in steps of 1/6 EV. The default is 0.

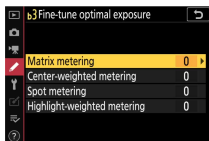

✔ Fine-tuning exposure

Regardless of the option selected for Custom Setting b3 [**Fine-tune optimal exposure**], the exposure compensation icon (☒) will not be displayed. The only way to determine how much exposure has been altered is to view the amount in the fine-tuning menu for Custom Setting b3.

b4: mode exposure comp.

MENU button ➡  Custom Settings menu



When set to [**Disable**], the exposure compensation cannot be adjusted in mode .

c: Timers/AE lock

c1: Shutter-release button AE-L

MENU button ➡  Custom Settings menu



Choose whether exposure locks when the shutter-release button is pressed.

Option		Description
 ON	[On (half press)]	Pressing the shutter-release button halfway locks exposure.
 ON	[On (burst mode)]	Exposure only locks while the shutter-release button is pressed all the way down.
	[Off]	Pressing the shutter-release button does not lock exposure.

c2: Self-timer

MENU button ➔  Custom Settings menu

Choose the length of the shutter release delay, the number of shots taken, and the interval between shots in self-timer mode.

Option	Description
[Self-timer delay]	Choose the length of the shutter-release delay.
[Number of shots]	Press  and  to choose the number of shots taken each time the shutter-release button is pressed; choose from values of from 1 to 9.
[Interval between shots]	Choose the interval between shots when [Number of shots] is more than 1.

c3: Power off delay

MENU button ➔  Custom Settings menu

Choose how long the monitor or viewfinder remains on when no operations are performed.

- Different settings can be chosen for [Playback], [Menus], [Picture review], and [Standby timer].
- [Standby timer] determines how long the monitor, viewfinder, or control panel remains on after the shutter-release button is pressed halfway. The monitor and viewfinder dim a few seconds before the standby timer expires. If [10 s] is selected, the timer will be extended to 20 seconds while the  menu is displayed.
- With the exception of [Picture review], each of the power-off delays is extended by one minute in self-timer mode.
- Longer power-off delays reduce battery endurance.

d: Shooting/display

d1: CL mode shooting speed

MENU button ➔  Custom Settings menu

Choose the frame advance rate for low-speed continuous release mode; options range from [4 fps] to [1 fps].

d2: Maximum shots per burst

MENU button ➔  Custom Settings menu

The maximum number of shots that can be taken in a single burst in continuous release modes can be set to any value between 1 and 100.

- Note that regardless of the option selected, there is no limit to the number of photos that can be taken in a single burst when a shutter speed of 1 s or slower is selected in mode **S** or **M**.

The memory buffer

Custom Setting d2 [**Maximum shots per burst**] is used to select the number of shots that can be taken in a single burst. The number of shots that can be taken before the memory buffer fills and shooting slows varies with image quality and other settings. When the buffer is full, the camera will display “r00” and the frame advance rate will drop.

d3: Exposure delay mode



MENU button ➔  Custom Settings menu

In situations where the slightest camera movement can blur pictures, shutter release can be delayed by from about 0.2 to 3 seconds after the shutter-release button is pressed.

d4: Shutter type

MENU button →  Custom Settings menu

Choose the type of shutter used for photographs.

Option	Description
 [Auto]	The camera chooses the shutter type automatically according to shutter speed. The electronic front-curtain shutter is used to reduce blur caused by camera shake at slow shutter speeds.
 [Mechanical shutter]	The camera uses the mechanical shutter for all photos.
 [Electronic front-curtain shutter]	The camera uses the electronic front-curtain shutter for all photos.

✓ “Mechanical shutter”

[Mechanical shutter] is not available with some lenses.

✓ The electronic front-curtain shutter

The fastest shutter speed available when [Electronic front-curtain shutter] is selected is 1/2000 s.

d5: Extended shutter speeds (M)

MENU button →  Custom Settings menu

If you select [On], you can extend the shutter speed when shooting in mode **M** up to 900 seconds (15 minutes). This is useful when you want to shoot with the shutter open for extended periods, such as for astronomical photography.

- To use extended shutter speeds, choose [On] and select a shutter speed of 60 s or slower. When shooting starts, the control panel switches to indicate that the shutter is open.

d6: File number sequence

MENU button →  Custom Settings menu

Choose a file numbering option.

Option	Description
[On]	When a new folder is created or a new memory card is inserted in the camera, file numbering will continue from the last number used. This simplifies file management by minimizing the occurrence of duplicate file names when multiple cards are used.
[Off]	When a new folder is created or a new memory card is inserted, file numbering restarts from 0001. If the current folder already contains images, file numbering will instead continue from the highest file number in the current folder. If you select [Off] after selecting [On], the camera will store the current file number. File numbering will resume from the previously-stored value the next time [On] is selected.
[Reset]	Reset the file numbering for [On]. If the current folder is empty, file numbering will restart from 0001 with the next picture taken. If the current folder contains images, the next picture taken will be assigned a file number by adding one to the highest file number in the current folder.

✔ File number sequence

- If a picture is taken when the current folder contains a picture numbered 9999, a new folder will be created and file numbering will restart from 0001.
- When the current folder number reaches 999, the camera will no longer be able to create new folders and the shutter release will be disabled if:
 - the current folder contains 5000 pictures (in addition, video recording will be disabled if the camera calculates that the number of files needed to record a video of the maximum length would result in the folder containing over 5000 files), or
 - the current folder contains a picture numbered 9999 (in addition, video recording will be disabled if the camera calculates that the number of files needed to record a video of the maximum length would result in a file numbered over 9999).

To resume shooting, choose [**Reset**] for Custom Setting d6 [**File number sequence**] and then either format the memory card or insert a new memory card.

✔ Folder numbering

- If a picture is taken when the current folder contains 5000 pictures or a picture numbered 9999, a new folder will be created and selected as the current folder.
- The new folder is assigned a number one higher than current folder number. If a folder with that number already exists, the new folder will be assigned the lowest available folder number.

d7: Apply settings to live view

MENU button ➔  Custom Settings menu

Choose whether the camera adjusts the preview in the viewfinder or monitor to reflect how shooting settings will affect the hue and brightness of the final picture. Regardless of the option selected, the effects of camera settings are always visible in video mode.

Option	Description
[On]	The effects of changes to settings such as white balance, Picture Controls, and exposure compensation are visible in the shooting display.
[Off]	<ul style="list-style-type: none"> • The effects of changes to settings such as white balance, Picture Controls, and exposure compensation are not visible in the shooting display. The hue and brightness of the display can be adjusted for ease of viewing during extended photo shoots. • A  icon appears in the shooting display.

d8: Framing grid display

MENU button ➡  Custom Settings menu

Display 3×3 (9 divisions) or 4×4 (16 divisions) grid lines, which are useful for checking composition on the display.

d9: Focus peaking

MENU button ➡  Custom Settings menu

When focus peaking is enabled in manual focus mode, objects that are in focus are indicated by colored outlines in the display. You can choose the color.

Peaking level

Choose from [3 (high sensitivity)], [2 (standard)], [1 (low sensitivity)], and [Off]. The higher the value, the greater the depth that will be shown as being in focus.

Peaking highlight color

Choose the highlight color.

d10: View all in continuous mode

MENU button →  Custom Settings menu

If [**Off**] is selected, the display will go blank during burst photography.

e: Bracketing/flash

e1: Flash sync speed

MENU button →  Custom Settings menu

Choose the flash sync speed.

Option	Description
[1/200 s (Auto FP)]	<p>Auto FP high-speed sync is enabled with compatible flash units and the maximum sync speed for other flash units is set to 1/200 s.</p> <ul style="list-style-type: none">• When the camera shows a shutter speed of 1/200 s in mode P or A, auto FP high-speed sync will be activated if the actual shutter speed is faster than 1/200 s. If the flash supports auto FP high-speed sync, the camera can select shutter speeds as fast as 1/4000 s.• In mode S or M, the user can select shutter speeds as fast as 1/4000 s when using flash units that support auto FP high-speed sync.• In mode S or M, if the shutter-speed dial is set to X, the shutter speed will be set to 1/200 s.
[1/200 s]	<p>Flash sync speed set to selected value, which can be from 1/200 to 1/60 s.</p>
[1/160 s]	<ul style="list-style-type: none">• In mode S or M, if the shutter-speed dial is set to X, the shutter speed will be the same as the sync speed.
[1/125 s]	<ul style="list-style-type: none">• In mode S or M, if the shutter-speed dial is set to a speed faster than the sync speed, the shutter speed will be the same as the sync speed.

Option	Description
[1/100 s]	Flash sync speed set to selected value, which can be from 1/200 to 1/60 s.
[1/80 s]	<ul style="list-style-type: none"> In mode S or M, if the shutter-speed dial is set to X, the shutter speed will be the same as the sync speed.
[1/60 s]	<ul style="list-style-type: none"> In mode S or M, if the shutter-speed dial is set to a speed faster than the sync speed, the shutter speed will be the same as the sync speed.

✓ Fixing shutter speed at the flash sync speed limit

In modes **S** and **M**, shutter speed can be fixed at the value selected for Custom Setting e1 [**Flash sync speed**] by setting the shutter-speed dial to **X**. An **X** (flash sync indicator) will appear in the shooting display together with the flash sync speed.

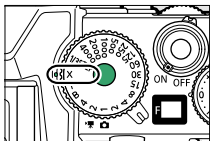

✓ Auto FP high-speed sync

- Auto FP high-speed sync allows the flash to be used at the highest shutter speed supported by the camera. When [1/200 s (**Auto FP**)] is selected, the camera automatically enables auto FP high-speed sync at shutter speeds faster than the flash sync speed. This makes it possible to choose the maximum aperture for reduced depth of field even when the subject is backlit in bright sunlight.

e2: Flash shutter speed

MENU button ➔ Custom Settings menu



Choose the slowest shutter speed available with a flash in mode **P** or **A**.

Regardless of the setting chosen for Custom Setting e2 [**Flash shutter speed**], shutter speeds can be as slow as 30 s in modes **S** and **M** or at flash settings of slow sync, slow rear-curtain sync, or red-eye reduction with slow sync.

e3: Exposure comp. for flash

MENU button ➡  Custom Settings menu



Choose how the camera adjusts flash level when exposure compensation is used.

	Option	Description
	[Entire frame]	The camera adjusts both the flash level and exposure. This changes the exposure for the entire frame.
	[Background only]	Exposure compensation is adjusted for the background only.

e4: Auto ISO sensitivity control

MENU button ➡  Custom Settings menu









Choose what the camera targets for exposure adjustment when auto ISO sensitivity control is enabled during flash photography.

	Option	Description
	[Subject and background]	The camera takes both the main subject and background lighting into account when adjusting ISO sensitivity.
	[Subject only]	ISO sensitivity is adjusted only to ensure that the main subject is correctly exposed.

e5: Auto bracketing (mode M)

MENU button ➔  Custom Settings menu

The settings affected when bracketing is enabled in mode **M** are determined by the options selected for **[Auto bracketing]** > **[Auto bracketing set]** in the photo shooting menu and the option chosen for Custom Setting e5 **[Auto bracketing (mode M)]**.

Custom Setting e5 [Auto bracketing (mode M)]		Photo shooting menu [Auto bracketing set]	
		AE & flash bracketing*	AE bracketing*
 	[Flash/speed]	Shutter speed and flash level	Shutter speed
  	[Flash/speed/aperture]	Shutter speed, aperture, and flash level	Shutter speed and aperture
  	[Flash/aperture]	Aperture and flash level	Aperture
	[Flash only]	Flash level	—

* If a flash is not used when **[On]** is selected for **[Auto ISO sensitivity control]** and **[Flash/speed]**, **[Flash/speed/aperture]**, or **[Flash/aperture]** is selected for e5 **[Auto bracketing (mode M)]**, ISO sensitivity will be fixed at the value for the first shot in each bracketing sequence.



Flash bracketing

Flash bracketing is performed only with i-TTL or A (auto aperture) flash control.

e6: Bracketing order

MENU button →  Custom Settings menu

Choose the order in which the shots in the bracketing program are taken.

Option		Description
	[MTR > under > over]	The unmodified shot is taken first, followed by the shot with the lowest value, followed by the shot with the highest value.
→+ 	[Under > MTR > over]	Shooting proceeds in order from the lowest to the highest value.

- Custom Setting e6 [**Bracketing order**] has no effect on the order of the shots taken when [**ADL bracketing**] is selected for [**Auto bracketing**] > [**Auto bracketing set**] in the photo shooting menu.



f: Controls



f1: Customize menu











MENU button →  Custom Settings menu













Choose the items listed in the **i** menu displayed when the **i** button is pressed in photo mode.

- Highlight a position in the **i** menu, press , and select the desired item.
- The following items can be assigned to the **i** menu.

Item	
 [Choose image area]	243
QUAL [Image quality]	160
SIZE [Image size]	161

Item	
 [Exposure compensation]	139
WB [White balance]	116

Item		📖
	[Set Picture Control]	147
RGB	[Color space]	262
	[Active D-Lighting]	164
	[Long exposure NR]	262
ISO NR	[High ISO NR]	263
	[Metering]	162
	[Flash mode]	502
	[Flash compensation]	504
AF/MF	[Focus mode]	100
	[AF-area mode]	102
	[Vibration reduction]	171
BKT	[Auto bracketing]	270
	[Multiple exposure]	281
HDR	[HDR (high dynamic range)]	289
	[Interval timer shooting]	296
	[Time-lapse video]	310

Item		📖
	[Focus shift shooting]	319
	[Silent photography]	327
	[Release mode]	166
	[Custom controls (shooting)]	367
	[Exposure delay mode]	356
	[Shutter type]	357
	[Apply settings to live view]	359
	[Focus peaking]	360
	[Monitor/viewfinder brightness]	394, 396
	[Bluetooth connection]	366
	[Wi-Fi connection]	164
	[Wireless remote connection]	413

Bluetooth connection

Enable or disable Bluetooth.

f2: Custom controls (shooting)

MENU button → Custom Settings menu

Choose the operations performed in photo mode using the camera controls or lens control ring.

- Choose the roles played by the controls below. Highlight the desired control and press **OK**.

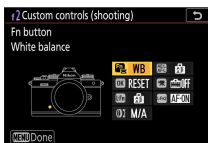

Option	
	[Fn button]
	[AE-L/AF-L button]
	[OK button]
	[Video record button]
	[Lens Fn button]
	[Lens Fn2 button]
	[Lens control ring]

- The roles that can be assigned to these controls are as follows:











Option								
RESET	[Select center focus point]	—	✓	✓	—	—	—	—
AF-ON	[AF-ON]	✓	✓	—	—	✓	✓	—
	[AF lock only]	✓	✓	—	—	✓	✓	—
	[AE lock (Hold)]	✓	✓	—	✓	✓	✓	—





Option							
	[AE lock (Reset on release)]	✓	✓	—	✓	✓	—
	[AE lock only]	✓	✓	—	—	✓	—
	[AE/AF lock]	✓	✓	—	—	✓	—
	[FV lock]	✓	—	—	—	✓	—
	[Disable/enable]	✓	—	—	—	✓	—
	[Preview]	✓	—	—	✓	✓	—
	[Matrix metering]	✓	—	—	—	✓	—
	[Center-weighted metering]	✓	—	—	—	✓	—
	[Spot metering]	✓	—	—	—	✓	—
	[Highlight-weighted metering]	✓	—	—	—	✓	—
	[Bracketing burst]	✓	—	—	—	✓	—
	[+ RAW]	✓	—	—	✓	✓	—
	[Subject tracking]	✓	—	—	—	✓	—
	[Silent photography]	✓	—	—	—	✓	—
	[Live view info display off]	✓	✓	—	✓	✓	—
	[Framing grid display]	✓	—	—	✓	✓	—
	[Zoom on/off]	✓	✓	✓	✓	✓	—
	[MY MENU]	✓	—	—	✓	✓	—
	[Access top item in MY MENU]	✓	—	—	✓	✓	—
	[Playback]	✓	—	—	—	✓	—
	[Choose image area]	✓	—	—	✓	—	—
QUAL	[Image quality/size]	✓	—	—	✓	—	—







Option								
WB	[White balance]	✓	—	—	✓	—	—	—
	[Set Picture Control]	✓	—	—	✓	—	—	—
	[Active D-Lighting]	✓	—	—	✓	—	—	—
	[Metering]	✓	—	—	✓	—	—	—
	[Flash mode/compensation]	✓	—	—	✓	—	—	—
	[Release mode]	✓	—	—	—	—	—	—
AF/[+]	[Focus mode/AF-area mode]	✓	—	—	✓	—	—	—
BKT	[Auto bracketing]	✓	—	—	✓	—	—	—
	[Multiple exposure]	✓	—	—	✓	—	—	—
HDR	[HDR (high dynamic range)]	✓	—	—	✓	—	—	—
	[Exposure delay mode]	✓	—	—	✓	—	—	—
	[Focus peaking]	✓	—	—	—	—	—	—
Non-CPU	[Choose non-CPU lens number]	✓	—	—	✓	—	—	—
M/A	[Focus (M/A)]	—	—	—	—	—	—	✓2, 3
	[Aperture]	—	—	—	—	—	—	✓3
	[Exposure compensation]	—	—	—	—	—	—	✓3
[None]		✓	✓	✓	✓	✓	✓	✓3









- 1 Regardless of the option selected, when [**Auto-area AF**], [**Auto-area AF (people)**], or [**Auto-area AF (animals)**] is chosen for AF-area mode, the button functions only to initiate subject-tracking AF (102).
- 2 Available with compatible lenses only.
- 3 Regardless of the option selected, in manual focus mode the control ring can only be used to adjust focus.



- The following options are available:





	Role	Description
	[Select center focus point]	Pressing the control selects the center focus point.
	[AF-ON]	Pressing the control initiates autofocus.
	[AF lock only]	Focus locks while the control is pressed.
	[AE lock (Hold)]	Exposure locks when the control is pressed. Exposure lock does not end when the shutter is released. Exposure remains locked until the control is pressed a second time or the standby timer expires.
	[AE lock (Reset on release)]	Exposure locks when the control is pressed. Exposure remains locked until the control is pressed a second time, the shutter is released, or the standby timer expires.
	[AE lock only]	Exposure locks while the control is pressed.
	[AE/AF lock]	Focus and exposure lock while the control is pressed.
	[FV lock]	Press the control to lock flash value for optional flash units; press again to cancel FV lock.
	[Disable/enable]	If the flash is currently enabled, it will be disabled while the control is pressed. If the flash is currently off, front-curtain sync will be selected while the control is pressed.
	[Preview]	Keep the control pressed to preview photo color, exposure, and depth of field.

	Role	Description
	[Matrix metering]	[Matrix metering] is activated while the control is pressed.
	[Center-weighted metering]	[Center-weighted metering] is activated while the control is pressed.
	[Spot metering]	[Spot metering] is activated while the control is pressed.
	[Highlight-weighted metering]	[Highlight-weighted metering] is activated while the control is pressed.
	[Bracketing burst]	<ul style="list-style-type: none"> - If the control is pressed when an option other than [WB bracketing] is selected for [Auto bracketing] > [Auto bracketing set] in the photo shooting menu in continuous release mode, the camera will take all the shots in the current bracketing program and repeat the bracketing burst while the shutter-release button is pressed. In single-frame release mode, shooting will end after the first bracketing burst. - If [WB bracketing] is selected for [Auto bracketing set], the camera will take pictures while the shutter-release button is pressed and apply white balance bracketing to each shot.

Role	Description
 [+ RAW]	<ul style="list-style-type: none"> - If a JPEG option is currently selected for image quality, "RAW" will be displayed and a RAW copy will be recorded with the next picture taken after the control is pressed. The original image quality setting will be restored when you remove your finger from the shutter-release button or press the control again, canceling [+ RAW]. - RAW copies are recorded at the settings currently selected for [RAW recording] in the photo shooting menu.
 [Subject tracking]	<p>Pressing the control when [Auto-area AF], [Auto-area AF (people)], or [Auto-area AF (animals)] is selected for AF-area mode enables subject tracking; the focus point will change to a targeting reticle and the monitor and viewfinder to subject-tracking displays.</p> <ul style="list-style-type: none"> - To end subject-tracking AF, press the control again or press the  (?) button.
 [Silent photography]	<p>Press the control to perform silent photography. Press again to cancel silent photography.</p>
 [Live view info display off]	<p>Press the control to hide the icons and shooting information on the display. Icons and shooting information can be displayed by pressing the button again.</p>
 [Framing grid display]	<p>Each time you press the button, the composition framing grid on the display changes between [Off], [On (3×3)], and [On (4×4)].</p>

Role		Description
	[MY MENU]	Press the control to display “MY MENU”.
	[Access top item in MY MENU]	Press the control to jump to the top item in “MY MENU”. Select this option for quick access to a frequently-used menu item.
	[Playback]	Press the control to start playback.
	[Choose image area]	Press the control and rotate a command dial to choose the image area.
QUAL	[Image quality/size]	Press the control and rotate the main command dial to choose an image quality option and the sub-command dial to select image size.
WB	[White balance]	To choose a white balance option, hold the button and rotate the main command dial. Some options offer sub-options that can be selected by rotating the sub-command dial.
	[Set Picture Control]	Press the control and rotate a command dial to choose a Picture Control.
	[Active D-Lighting]	Press the control and rotate a command dial to adjust Active D-Lighting.
	[Metering]	Press the control and rotate a command dial to choose a metering option.
	[Flash mode/compensation]	Press the control and rotate the main command dial to choose a flash mode and the sub-command dial to adjust flash output.











Role	Description
 [Release mode]	Press the control and rotate the main command dial to choose a release mode. When the release mode is [Continuous L], you can change the frame advance rate setting by rotating the sub-command dial, and when the release mode is [Self-timer], you can change the setting of the time until the shutter is released by rotating the sub-command dial.
AF/[+] [Focus mode/AF-area mode]	Hold the control and rotate the main command dial to choose the focus mode, the sub-command dial to choose the AF-area mode.
BKT [Auto bracketing]	Press the control and rotate the main command dial to choose the number of shots and the sub-command dial to select the bracketing increment or Active D-Lighting amount.
 [Multiple exposure]	Press the control and rotate the main command dial to choose the mode and the sub-command dial to choose the number of shots.
HDR [HDR (high dynamic range)]	Press the control and rotate the main command dial to choose the mode and the sub-command dial to choose the exposure differential.
 [Exposure delay mode]	Press the control and rotate a command dial to choose the shutter-release delay.





Role		Description
 [Focus peaking]		Press the control and rotate the main command dial to choose a peaking level and the sub-command dial to select the peaking color.
 [Choose non-CPU lens number]		Press the control and rotate a command dial to choose a lens number saved using the [Non-CPU lens data] item in the setup menu.
 [Focus (M/A)]		Autofocus can be over-riden by rotating the lens control ring (autofocus with manual override). The control ring can be used for manual focus while the shutter-release button is pressed halfway. To refocus using autofocus, lift your finger from the shutter-release button and then press it halfway again.
 [Aperture]		Rotate the lens control ring to adjust aperture.
 [Exposure compensation]		Rotate the lens control ring when the exposure compensation dial is set to [C] to adjust exposure compensation.
[None]		The control has no effect.

f3: Custom controls (playback)

MENU button ➔  Custom Settings menu



Choose the role assigned to the camera buttons during playback.

Option	Role	Description
 [AE-L/AF-L button]	 [Protect]	Press the control to protect the current picture.
	 [Rating]	When you press the control, you can press  or  or rotate the main command dial to change the rating setting for the displayed image.
	 [Zoom on/off]	Press the control to zoom the display in on the area around the current focus point (the zoom ratio is selected in advance). Press again to cancel zoom. <ul style="list-style-type: none"> To choose the zoom ratio, highlight [Zoom on/off] and press . Zoom is available in both full-frame and thumbnail playback.
	[None]	The control has no effect.
 [OK button]*	 [Thumbnail on/off]	Press the control to toggle between full-frame playback, 4-, 9-, and 72-frame thumbnail playback, and calendar playback.
	 [View histograms]	A histogram is displayed while the control is pressed. The histogram display is available in both full-frame and thumbnail playback.

Option	Role		Description
 [OK button]*		[Zoom on/off]	Press the control to zoom the display in on the area around the current focus point (the zoom ratio is selected in advance). Press again to cancel zoom. <ul style="list-style-type: none"> To choose the zoom ratio, highlight [Zoom on/off] and press . Zoom is available in both full-frame and thumbnail playback.
		[Choose folder]	Press the control to display the [Choose folder] dialog, where you can then choose a folder for playback.

* Regardless of the option selected, pressing  when a video is displayed full frame starts video playback.





f4: Customize command dials

MENU button   Custom Settings menu

Customize the operation of the main and sub-command dials.

Reverse rotation

Reverse the direction of rotation of the command dials for selected operations.

- Highlight **[Exposure compensation]** or **[Shutter speed/aperture]** and press  to select () or deselect (.
- Press  to save changes and exit.

Change main/sub



Reverse the roles of the main- and sub-command dials.

Option	Description
[Exposure setting]	If [On] is selected, the main command dial will control aperture and the sub-command dial shutter speed. If [On (Mode A)] is selected, the main command dial will be used to set aperture in mode A only.
[Autofocus setting]	If [On] is selected and [Focus mode/AF-area mode] has been assigned to a control using Custom Setting f2 [Custom controls (shooting)] , you can choose the AF-area mode by holding the control and rotating the main command dial and focus mode by holding the control and rotating the sub-command dial.

Menus and playback

Choose the roles played by the multi selector and command dials during playback and menu navigation.





Option	Description
[On]	<p>Playback:</p> <ul style="list-style-type: none"> The main command dial can be used to choose the picture displayed during full-frame playback. The sub-command dial can be used to skip forward or back according to the option selected for [Sub-dial frame advance]. During thumbnail playback, the main command dial can be used to highlight thumbnails and the sub-command dial to page up or down. <p>Menus*:</p> <p>Use the main command dial to highlight menu items. Rotating the sub-command dial right displays the sub-menu for the highlighted option. Rotating it left displays the previous menu.</p>
ON [Ⓞ] [On (picture review excluded)]	As for [On] except that the command dials cannot be used for playback during picture review.
[Off]	Use the multi selector to choose the picture displayed during full-frame playback or to highlight pictures or menu items.

* The sub-command dial cannot be used to select highlighted items. To select highlighted items, press  or .

Sub-dial frame advance

Choose the operation performed when rotating the sub-command dial during full-frame playback. This option only takes effect when [On] or [On (picture review excluded)] is selected for [Menus and playback].

Option	Description
[10 frames]	Skip forward or back 10 frames at a time.

Option	Description
[50 frames]	Skip forward or back 50 frames at a time.
★ [Rating]	Skip to the next or previous pictures with the selected rating. To choose the rating, highlight [Rating] and press  .
 [Protect]	Skip to the next or previous protected picture.
 [Photos only]	Skip to the next or previous photo.
 [Videos only]	Skip to the next or previous video.
 [Folder]	Rotate the sub-command dial to select a folder.

f5: Release button to use dial

MENU button ➔  Custom Settings menu



Selecting [Yes] allows adjustments that are normally made by holding a button and rotating a command dial to be made by rotating the command dial after the button is released. This ends when the button is pressed again, the shutter-release button is pressed halfway, or the standby timer expires.

- [Release button to use dial] applies to controls to which the following roles have been assigned using Custom Settings f2 [Custom controls (shooting)] or g2 [Custom controls]: [Choose image area], [Image quality/size], [White balance], [Set Picture Control], [Active D-Lighting], [Metering], [Flash mode/compensation], [Release mode], [Release mode (save frame)], [Focus mode/AF-area mode], [Auto bracketing], [Multiple exposure], [HDR (high dynamic range)], [Exposure delay mode], [Focus peaking], [Choose non-CPU lens number], and [Microphone sensitivity].

f6: Reverse indicators

MENU button →  Custom Settings menu

Choose whether the exposure indicator is displayed with negative values on the left and positive values on the right, or with positive values on the left and negative values on the right.

	Option	Description
+0-		The indicator is displayed with positive values on the left and negative values on the right.
-0+		The indicator is displayed with negative values on the left and positive values on the right.







g: Video









g1: Customize menu







MENU button →  Custom Settings menu

Choose the items listed in the *i* menu displayed when the *i* button is pressed in video mode.

- Highlight a position in the *i* menu, press , and select the desired item.
- The following items can be assigned to the *i* menu.

	Item			Item	
	[Frame size and rate/Video quality]	175		[Set Picture Control]	175
	[Exposure compensation]	139		[Active D-Lighting]	181
WB	[White balance]	175		[Metering]	180
			AF/MF	[Focus mode]	182

Item		📖
	[AF-area mode]	182
	[Vibration reduction]	182
	[Electronic VR]	181
	[Microphone sensitivity]	178
	[Attenuator]	338
	[Frequency response]	338
	[Wind noise reduction]	179
	[Release mode (save frame)]	335

Item		📖
	[Focus peaking]	360
	[Highlight display]	389
	[Monitor/viewfinder brightness]	394, 396
	[Bluetooth connection]	382
	[Wi-Fi connection]	164, 180
	[Wireless remote connection]	413

Bluetooth connection

Enable or disable Bluetooth.

g2: Custom controls

MENU button ➡  Custom Settings menu







Choose the operations performed in video mode using the camera controls or lens control ring.









Option								
[Live view info display off]	✓	✓	—	—	✓	✓	—	
[Framing grid display]	✓	—	—	—	✓	✓	—	
[Zoom on/off]	✓	✓	✓	—	✓	✓	—	
[MY MENU]	✓	—	—	—	✓	✓	—	
[Access top item in MY MENU]	✓	—	—	—	✓	✓	—	
[Playback]	✓	—	—	—	✓	✓	—	
[Take photos]	—	—	—	✓	—	—	—	
[Record videos]	—	✓	✓	✓	—	—	—	
WB [White balance]	✓	—	—	—	—	—	—	
[Set Picture Control]	✓	—	—	—	—	—	—	
[Active D-Lighting]	✓	—	—	—	—	—	—	
[Metering]	✓	—	—	—	—	—	—	
[Release mode (save frame)]	✓	—	—	—	—	—	—	
AF/+ [Focus mode/AF-area mode]	✓	—	—	—	—	—	—	
[Microphone sensitivity]	✓	—	—	—	—	—	—	
[Focus peaking]	✓	—	—	—	—	—	—	
M/A [Focus (M/A)]	—	—	—	—	—	—	✓2, 3	
[Power aperture]	—	—	—	—	—	—	✓3	
[Exposure compensation]	—	—	—	—	—	—	✓3	
[None]	✓	✓	✓	—	✓	✓	✓3	







- 1 Regardless of the option selected, when [Auto-area AF], [Auto-area AF (people)], or [Auto-area AF (animals)] is chosen for AF-area

mode, the button functions only to initiate subject-tracking AF (□102).

- 2 Available with compatible lenses only.
 - 3 Regardless of the option selected, in manual focus mode the control ring can only be used to adjust focus.
- The following options are available:

	Role	Description
RESET	[Select center focus point]	Pressing the control selects the center focus point.
	[AF-ON]	Pressing the control initiates autofocus.
	[AF lock only]	Focus locks while the control is pressed.
	[AE lock (Hold)]	Exposure locks when the control is pressed. Exposure lock does not end when the shutter is released. Exposure remains locked until the control is pressed a second time or the standby timer expires.
	[AE lock only]	Exposure locks while the control is pressed.
	[AE/AF lock]	Focus and exposure lock while the control is pressed.
	[Subject tracking]	Pressing the control when [Auto-area AF], [Auto-area AF (people)], or [Auto-area AF (animals)] is selected for AF-area mode enables subject tracking; the focus point will change to a targeting reticle and the monitor and viewfinder to subject-tracking displays. <ul style="list-style-type: none"> • To end subject-tracking AF, press the control again or press the  (?) button.

	Role	Description
	[Live view info display off]	Press the control to hide the icons and shooting information on the display. Icons and shooting information can be displayed by pressing the button again.
	[Framing grid display]	Each time you press the button, the composition framing grid on the display changes between [Off], [On (3x3)], and [On (4x4)].
	[Zoom on/off]	Press the control to zoom the display in on the area around the current focus point (the zoom ratio is selected in advance). Press again to cancel zoom.
	[MY MENU]	Press the control to display "MY MENU".
	[Access top item in MY MENU]	Press the control to jump to the top item in "MY MENU". Select this option for quick access to a frequently-used menu item.
	[Playback]	Press the control to start playback.
	[Take photos]	Press the shutter-release button all the way down to take a photograph with an aspect ratio of 16:9.
	[Record videos]	Press the control to start recording. Press again to end recording.
WB	[White balance]	Hold the control and rotate the main command dial to adjust white balance for videos. Some options offer sub-options that can be selected by rotating the sub-command dial.

	Role	Description
	[Set Picture Control]	Press the control and rotate a command dial to choose a Picture Control.
	[Active D-Lighting]	Press the control and rotate a command dial to adjust Active D-Lighting for videos.
	[Metering]	Press the control and rotate a command dial to choose a video metering option.
	[Release mode (save frame)]	Press the control and rotate a command dial to choose the release mode for photographs taken in video mode.
AF/[+]	[Focus mode/AF-area mode]	Hold the control and rotate the main command dial to choose the focus mode, the sub-command dial to choose the AF-area mode.
	[Microphone sensitivity]	Press the control and rotate a command dial to adjust microphone sensitivity.
PEAK	[Focus peaking]	Press the control and rotate the main command dial to choose a peaking level and the sub-command dial to select the peaking color.
M/A	[Focus (M/A)]	The lens control ring can be used for manual focus regardless of the option selected for focus mode. To refocus using autofocus, press the shutter-release button halfway or press a control to which AF-ON has been assigned.
	[Power aperture]	Rotate the lens control ring to adjust aperture.

	Role	Description
<input checked="" type="checkbox"/>	[Exposure compensation]	Rotate the lens control ring when the exposure compensation dial is set to [C] to adjust exposure compensation.
	[None]	The control has no effect.

✓ Power aperture

- Power aperture is available only in modes **A** and **M**.
- A  icon in the shooting display indicates that power aperture cannot be used.
- The display may flicker while aperture is adjusted.

g3: AF speed

MENU button →  Custom Settings menu

Choose the focus speed in video mode when the focus mode is set to **AF-C** or **AF-F**.

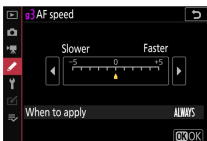

Use [**When to apply**] to choose when the selected option applies.

	Option	Description
ALWAYS	[Always]	The camera focuses at the selected speed at all times in video mode.
REC	[Only while recording]	Focus is adjusted at the selected speed only during video recording. At other times, the focus speed is "+5", or in other words as fast possible.

g4: AF tracking sensitivity

MENU button ➔  Custom Settings menu

Set the AF tracking sensitivity from values 1 to 7 in video mode when the focus mode is set to **AF-C** or **AF-F**.

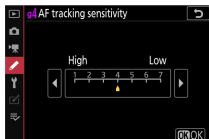

- Choose **[7 (Low)]** to help maintain focus on your original subject.
- If the subject leaves the selected focus area when **[1 (High)]** is selected, the camera will respond by quickly shifting focus to a new subject in the same area.

g5: Highlight display

MENU button ➔  Custom Settings menu

Choose whether shading is used to indicate highlights (bright areas of the frame) during video recording.

Display pattern

To enable the highlight display, select **[Pattern 1]** or **[Pattern 2]**.

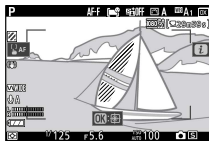

Pattern 1

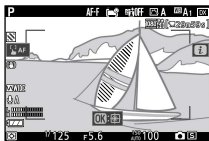

Pattern 2

Highlight display threshold

Choose the brightness needed to trigger the video highlight display. The lower the value, the greater the range of brightnesses that will be shown as highlights. If **[255]** is selected, the highlight display will show only areas that are potentially overexposed.

Highlight display



If both the highlight display and focus peaking are enabled, only focus peaking will be displayed in manual focus mode. To view the highlight display in manual focus mode, select **[Off]** for Custom Setting d9 **[Focus peaking]** > **[Peaking level]**.

The setup menu: Camera setup

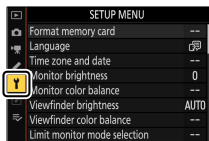
To view the setup menu, select the  tab in the camera menus.



The setup menu contains the following items:

Item		Item	
[Format memory card]	392	[Pixel mapping]	403
[Language]	393	[Image comment]	404
[Time zone and date]	393	[Copyright information]	405
[Monitor brightness]	394	[Beep options]	406
[Monitor color balance]	394	[Touch controls]	407
[Viewfinder brightness]	396	[Self-portrait mode]	408
[Viewfinder color balance]	396	[HDMI]	408
[Limit monitor mode selection]	397	[Airplane mode]	408
[Information display]	397	[Connect to smart device]	408
[AF fine-tuning options]	397	[Connect to computer]	411
[Non-CPU lens data]	400	[Wireless remote (ML-L7) options]	413
[Save focus position]	401	[Conformity marking]	415
[Image Dust Off ref photo]	401	[USB power delivery]	415

Item	📖
[Energy saving (photo mode)]	417
[Slot empty release lock]	418
[Save/load menu settings]	419

Item	📖
[Reset all settings]	423
[Firmware version]	423

✔ See also

“Setup menu defaults” (📖227)

Format memory card

MENU button ➔ 📏 setup menu

Format memory cards. **Note that formatting permanently deletes all pictures and other data on the card.** Before formatting, be sure to make backup copies as required.

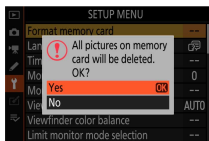

✔ During formatting

Do not turn the camera off or remove memory cards until the message [Format memory card] clears from the display.

Language

MENU button ➡  setup menu

Choose a language for camera menus and messages. The languages available vary with the country or region in which the camera was originally purchased.

Time zone and date

MENU button ➡  setup menu



Change time zones and set the camera clock. We recommend that the camera clock be adjusted regularly.

Option	Description
[Time zone]	Choose a time zone. [Date and time] is automatically set to the time in the new time zone.
[Date and time]	Set the camera clock to the time in the selected [Time zone].
[Date format]	Choose the order in which the day, month, and year are displayed.
[Daylight saving time]	Select [On] to turn daylight saving time on, [Off] to turn it off. Selecting [On] automatically advances the clock one hour. The default setting is [Off].

If the camera clock has been initialized, the  icon is displayed in the shooting display as a warning.

Monitor brightness

MENU button ➔  setup menu

Press  or  to adjust monitor brightness. Choose higher values for increased brightness, lower values for reduced brightness.





- [**Monitor brightness**] can only be adjusted when the monitor is the active display. It cannot be adjusted when [**Viewfinder only**] is selected for monitor mode or when your eye is to the viewfinder.
- Higher values increase the drain on the battery.

Monitor color balance

MENU button ➔  setup menu

Adjust monitor color balance to your taste.

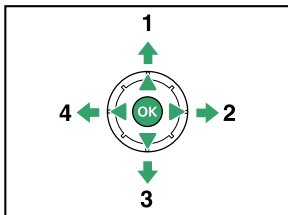
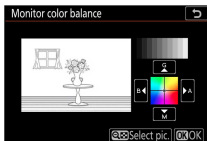

- [**Monitor color balance**] can only be adjusted when the monitor is the active display. It cannot be adjusted when [**Viewfinder only**] is selected for monitor mode or when your eye is to the viewfinder.

- Color balance is adjusted using the multi selector. Press , , , or  to adjust color balance as shown below. Press  to save changes.



- 1** Increase green
- 2** Increase amber

- 3** Increase magenta
- 4** Increase blue

- Monitor color balance applies only to menus, playback, and the shooting display; photos and videos taken with the camera are not affected.
- The reference image is either the last picture taken or, in playback mode, the picture last displayed. If the memory card contains no pictures, an empty frame will be displayed instead.
- To choose a different picture, press the  (?). Highlight the desired picture and press  to select it as the reference image.

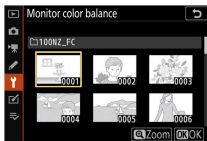



- To view the highlighted picture zoomed in, press and hold the  button.

Viewfinder brightness

MENU button ➔  setup menu

- Adjust viewfinder brightness. [**Viewfinder brightness**] can only be adjusted when the viewfinder is the active display. It cannot be adjusted in the monitor or when [**Monitor only**] is selected for monitor mode.
- Higher values increase the drain on the battery.

Option	Description
[Auto]	Viewfinder brightness is adjusted automatically in response to lighting conditions.
[Manual]	Press  or  to adjust brightness manually. Choose higher values for increased brightness, lower values for reduced brightness.

Viewfinder color balance



MENU button ➔  setup menu

Adjust viewfinder color balance to your taste. [**Viewfinder color balance**] can only be adjusted when the viewfinder is the active display. It cannot be adjusted in the monitor or when [**Monitor only**] is selected for monitor mode. Otherwise the procedure is the same as for [**Monitor color balance**] (394).

Limit monitor mode selection

MENU button ➔  setup menu

Choose the monitor modes that can be selected using the  button.

- Highlight an option and press  to select () or deselect ().
Options marked with a check () are available for selection.
- To complete the operation, press .

Information display

MENU button ➔  setup menu

Adjust the appearance of the information display according to lighting conditions.

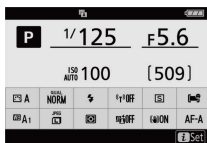

Dark on light

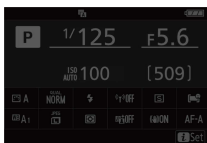

Light on dark







	Option	Description
B	[Dark on light]	To make the display easier to read in bright locations, the monitor lights and the lettering is displayed in black.
W	[Light on dark]	To make the display easier to read in dark locations, the monitor dims and the lettering is displayed in white.

AF fine-tuning options

MENU button ➔  setup menu

Fine-tune focus for the current lens.

- Use only as required.
- We recommend that you perform fine-tuning at a focus distance you use frequently. If you perform focus-tuning at a short focus distance, for example, you may find it less effective at longer distances.

Option	Description
[AF fine-tune]	<ul style="list-style-type: none"> • [On]: Turn AF fine-tuning on. • [Off]: Turn AF fine-tuning off.
[Fine-tune and save lens]	<p>Fine-tune focus for the current lens. Press  or  to highlight items and press  or  to choose from values between +20 and -20.</p> <ul style="list-style-type: none"> • The larger the fine-tuning value, the farther the focal point is from the lens; the smaller the value, the closer the focal point. • The display shows the current and previous values. • The camera can store values for up to 40 lens types. • If a lens for which values have already been saved is used, the fine-tuning values will be overwritten.
[Default]	<p>Choose the fine-tuning values for lenses for which no values have previously been saved using [Fine-tune and save lens]. Press  or  to choose from values between +20 and -20.</p>

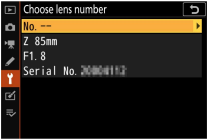
Option	Description
<p>[List saved values]</p>	<p>List values saved using [Fine-tune and save lens]. Highlighting a lens in the list and pressing  displays a [Choose lens number] dialog.</p>  <ul style="list-style-type: none"> • The [Choose lens number] dialog is used to enter the lens identifier. • The serial number is automatically entered for Z mount lenses and some F mount lenses.

Deleting saved values

To delete values saved using [**Fine-tune and save lens**], highlight the desired lens in the [**List saved values**] list and press .



Creating and saving fine-tuning values

1 Attach the lens to the camera.

2 Select [**AF fine-tuning options**] in the setup menu, then highlight [**Fine-tune and save lens**] and press .

An AF fine-tuning dialog will be displayed.

3 Press or to fine-tune autofocus.

- Choose from values between +20 and -20.
- The current value is shown by ▲, the previously-selected value by △.
- If a zoom lens is attached, you can choose separate fine-tuning values for maximum angle (WIDE) and maximum zoom (TELE). Use  and  to choose between the two.
- The larger the fine-tuning value, the farther the focal point is from the lens; the smaller the value, the closer the focal point.

4 Press to save the new value.

Choosing a default fine-tuning value

1 Select [AF fine-tuning options] in the setup menu, then highlight [Default] and press .

2 Press or to fine-tune autofocus.

- Choose from values between +20 and -20.
- The current value is shown by ▲, the previously-selected value by △.
- The larger the fine-tuning value, the farther the focal point is from the lens; the smaller the value, the closer the focal point.

3 Press to save the new value.

Non-CPU lens data

MENU button ➔  setup menu

Record data for non-CPU lenses attached using an optional mount adapter. By registering the focal length and maximum aperture of a non-CPU lens in the camera, you can display this data as shooting data.

Option	Description
[Lens number]	Choose a lens identifier.
[Focal length (mm)]	Enter the focal length.
[Maximum aperture]	Enter the maximum aperture.

Save focus position

MENU button ➡  setup menu

If set to **[On]**, the focus position is saved at the same position as before the camera was turned off when you turn it off and then on again.

- The focus position may change depending on the zoom operation and temperature changes.
- This function is enabled only when a Z mount lens with an autofocus function is attached.
- If set to **[On]**, it may take some time before you can operate the camera after turning it on.

Image Dust Off ref photo

MENU button ➡  setup menu

Acquire reference data for the Image Dust Off option in NX Studio. Image Dust Off processes RAW images to mitigate effects caused by dust adhering in front of the camera image sensor. For more information, refer to NX Studio online help.

Acquiring Image Dust Off reference data

1 Select [Start] on the Image Dust Off ref photo dialog.

- Highlight [Start] and press \odot to display the shooting screen.

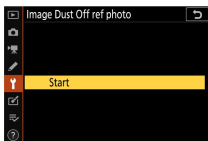

2 With the lens about ten centimeters (four inches) from a well-lit, featureless white object, frame the object so that it fills the display and then press the shutter-release button halfway.

- In autofocus mode, focus will automatically be set to infinity.
- In manual focus mode, set focus to infinity manually.

3 Press the shutter-release button the rest of the way down to acquire Image Dust Off reference data.

- The monitor turns off when the shutter-release button is pressed.
- If the reference object is too bright or too dark, the camera may be unable to acquire Image Dust Off reference data and a message will be displayed and the camera will return to the display shown in Step 1. Choose another reference object and press the shutter-release button again.

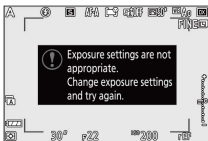

✔ Acquiring Image Dust Off reference data

- A lens with a focal length of at least 50 mm is recommended.
- When using a zoom lens, zoom all the way in.
- The same reference data can be used for photographs taken with different lenses or at different apertures.
- Reference images cannot be viewed using computer imaging software.
- A grid pattern is displayed when reference images are viewed on the camera.

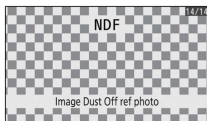

Pixel mapping

MENU button ➡  setup menu

Pixel mapping checks and optimizes the camera image sensor. If you notice unexpected bright spots appearing in pictures taken with the camera, perform pixel mapping as described below.

- Pixel mapping is available only when a Z mount lens or an optional FTZ mount adapter is attached.
- To prevent unexpected loss of power, use a fully-charged battery or an optional charging AC adapter.

1 Select [Pixel mapping] in the setup menu.

Turn the camera on, press the MENU button, and select [Pixel mapping] in the setup menu.

2 Select [Start].

Pixel mapping will start. A message is displayed while the operation is in progress.

3 Turn the camera off when pixel mapping is complete.

✔ Pixel mapping



- Do not attempt to operate the camera while pixel mapping is in progress. Do not turn the camera off or remove the battery.
- Pixel mapping may not be available if the camera's internal temperature is elevated.

Image comment



MENU button →  setup menu

Add a comment to new photographs as they are taken. Comments can be viewed in NX Studio's **[Info]** tab.

Input comment

Input a comment of up to 36 characters. Highlight **[Input comment]** and press  to display a text-entry dialog. For information on text entry, see "Text entry" (239).

Attach comment

To attach the comment to subsequent photographs, highlight **[Attach comment]**, press , and confirm that a check () appears in the adjacent check box. Press  to save changes and exit; the comment will be attached to all subsequent photographs.

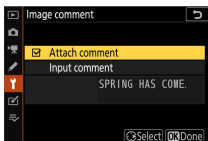

✔ Photo info

Comments can be viewed on the shooting data page in the photo information display.

Copyright information



MENU button ➔  setup menu

Add copyright information to new photographs as they are taken. Copyright information can be viewed in NX Studio's **[Info]** tab.

Artist/Copyright

Enter the names of the photographer (maximum 36 characters) and copyright holder (maximum 54 characters). Highlight **[Artist]** or **[Copyright]** and press  to display a text-entry dialog. For information on text entry, see "Text entry" (□239).

Attach copyright information

To attach copyright information to subsequent photographs, highlight **[Attach copyright information]**, press , and confirm that a check () appears in the adjacent check box. Press  to save changes and exit; copyright information will be attached to all subsequent photographs.



✔ Copyright information

- To prevent unauthorized use of the artist or copyright holder names, make sure that [**Attach copyright information**] is not selected before lending or transferring the camera to another person. You will also need to make sure that the artist and copyright fields are blank.
- Nikon does not accept liability for any damages or disputes arising from the use of the [**Copyright information**] option.

✔ Photo info

Copyright information is included in the shooting data shown in the photo information display.

Beep options

MENU button ➡  setup menu

Beep on/off

Turn the beep speaker on or off.

- If [**On**] is selected for [**Beep on/off**], beeps sound when:
 - the self-timer counts down,
 - interval-timer photography, time-lapse video recording, or focus shift ends,
 - the camera focuses in photo mode (note that this does not apply if **AF-C** is selected for focus mode or when **AF-A** is selected and you are shooting in **AF-C**, and [**Release**] is selected for Custom Setting a2 [**AF-S priority selection**]),
 - touch controls are used, or
 - the shutter-release button is pressed with a write-protected memory card inserted in the camera.
- Select [**Off (touch controls only)**] to disable the beep for touch controls while enabling it for other purposes.

- When **[On]** is selected for **[Silent photography]** in the photo shooting menu, a beep will not sound when the camera focuses or while the self-timer is in operation, regardless of the settings selected for **[Beep options]**.

Volume

Adjust beep volume.

Pitch

Choose the pitch of the beep from **[High]** and **[Low]**.

Touch controls

MENU button ➡  setup menu

Adjust settings for monitor touch controls.

Enable/disable touch controls

Enable or disable touch controls. Select **[Playback only]** to enable touch controls in playback mode only.

Full-frame playback flicks

Choose whether the next image in full-frame playback is displayed by flicking left or by flicking right.

	Option	Description
←	[Left←Right]	Flick left to display the next picture.
➡	[Left→Right]	Flick right to view the next picture.

Self-portrait mode

MENU button ➡  setup menu

When set to [**Disable**], the monitor will not switch to self-portrait mode even if it is set to the self-portrait mode position.

HDMI

MENU button ➡  setup menu

Adjust settings for connection to HDMI devices (□494).

Airplane mode

MENU button ➡  setup menu

Select [**Enable**] to disable the camera's built-in Bluetooth and Wi-Fi functions.

Connect to smart device

MENU button ➡  setup menu

Connect to smartphones or tablets (smart devices) via Bluetooth or Wi-Fi.

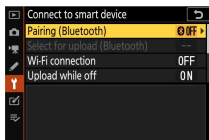

Pairing (Bluetooth)

Pair with or connect to smart devices using Bluetooth.

Option	Description
[Start pairing]	Pair the camera with a smart device (☐480).
[Paired devices]	List paired smart devices. To connect, select a device from the list.
[Bluetooth connection]	Select [Enable] to enable Bluetooth.

Select for upload (Bluetooth)

Select pictures for upload to a smart device. You can also opt to upload pictures as they are taken.

Option	Description
[Auto select for upload]	Select [On] to mark pictures for upload as they are taken. Photos are uploaded in JPEG format at a size of 2 megapixels, even if other upload size and format options are selected with the camera. Photos taken in video mode will not be uploaded. They must be uploaded manually.
[Manually select for upload]	Upload selected pictures. Transfer marking appears on the selected pictures.
[Deselect all]	Remove transfer marking from all pictures.

Wi-Fi connection

Connect to smart devices via Wi-Fi.

■■ Establish Wi-Fi connection

Initiate a Wi-Fi connection to a smart device.

- The camera SSID and password will be displayed. To connect, select the camera SSID on the smart device and enter the password (☐483).

- Once a connection is established, this option will change to **[Close Wi-Fi connection]**.
- Use **[Close Wi-Fi connection]** to end the connection when desired.

■ Wi-Fi connection settings

Access the following Wi-Fi settings:

Option	Description
[SSID]	Choose the camera SSID.
[Authentication/encryption]	Choose [OPEN] or [WPA2-PSK-AES] .
[Password]	Choose the camera password.
[Channel]	Choose a channel. <ul style="list-style-type: none"> • Select [Auto] to have the camera choose the channel automatically. • Select [Manual] to choose the channel manually.
[Current settings]	View current Wi-Fi settings.
[Reset connection settings]	Select [Yes] to reset Wi-Fi settings to default values.

Upload while off

If **[On]** is selected, upload of images to smart devices connected via Bluetooth or Wi-Fi will continue even when the camera is off.

Location data (smart device)

Display latitude, longitude, altitude, and UTC (Universal Coordinated Time) data downloaded from a smart device.

Connect to computer

MENU button ➔  setup menu

Connect to computers via Wi-Fi.

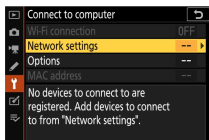



Wi-Fi connection

Select [**Enable**] to connect using the settings currently selected for [**Network settings**].

Network settings

Select [**Create profile**] to create a new network profile (□459, □465).

- If more than one profile already exists, you can press  to select a profile from a list.
- To edit an existing profile, highlight it and press .

Option	Description
[General]	<ul style="list-style-type: none">• [Profile name]: Rename the profile. The default profile name is the same as the network SSID.• [Password protection]: Select [On] to require that a password be entered before the profile can be changed. To change the password, highlight [On] and press .

Option	Description
[Wireless]	<ul style="list-style-type: none"> • Infrastructure mode: Adjust settings for connection to a network via a router. <ul style="list-style-type: none"> - [SSID]: Enter the network SSID. - [Channel]: Selected automatically. - [Authentication/encryption]: Choose [OPEN] or [WPA2-PSK-AES]. - [Password]: Enter the network password. • Access-point mode: Adjust settings for direct wireless connection to the camera. <ul style="list-style-type: none"> - [SSID]: Choose the camera SSID. - [Channel]: Choose [Auto] or [Manual]. - [Authentication/encryption]: Choose [OPEN] or [WPA2-PSK-AES]. - [Password]: If [WPA2-PSK-AES] is selected for [Authentication/encryption], you can choose the camera password.
[TCP/IP]	<p>Adjust TCP/IP settings for infrastructure connections. An IP address is required.</p> <ul style="list-style-type: none"> • If [Enable] is selected for [Obtain automatically], the IP address and sub-net mask for infrastructure mode connections will be acquired via a DHCP server or automatic IP addressing. • Select [Disable] to enter the IP address ([Address]) and sub-net mask ([Mask]) manually.

Options

Adjust upload settings.

■ ■ Auto upload

Select [On] to upload new photos as they are taken.

- Upload begins only after the photo has been recorded to the memory card. Be sure a memory card is inserted in the camera.
- Videos and photos taken during video mode are not uploaded automatically when recording is complete. They must instead be uploaded from the playback display (□473).

■ ■ Delete after upload

Select [**Yes**] to delete photographs from the camera memory card automatically once upload is complete.

- Files marked for transfer before you selected [**Yes**] are not deleted.
- Deletion may be suspended during some camera operations.

■ ■ Upload file as

When uploading RAW + JPEG images, choose whether to upload both the RAW and JPEG files or only the JPEG copy.

- The option chosen for [**Upload file as**] takes effect when [**On**] is selected for [**Auto upload**].

■ ■ Deselect all?

Select [**Yes**] to remove transfer marking from all images. Upload of images with an “uploading” icon will immediately be terminated.

MAC address

View the MAC address.

Wireless remote (ML-L7) options

MENU button ➔  setup menu

Connect an optional ML-L7 Remote Control through Bluetooth. You can also assign roles to the **Fn1/Fn2** buttons on the ML-L7.

- For the functions that can be used with the remote control and connecting this camera and the remote control, see “ML-L7 Remote Control” in “Other compatible accessories” (p.567).

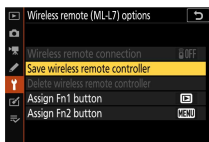

Wireless remote connection

Option	Description
[Enable]	Start connecting a paired ML-L7. If the camera is connected to a smartphone or computer, connection to those devices will be terminated.
[Disable]	Disconnect the ML-L7.

Save wireless remote controller

Pair the camera with an ML-L7. When the camera is in pairing standby, press and hold the power button on the remote control for about 3 seconds or longer. When pairing is complete, the remote control status lamp flashes green at about 3 second intervals.





Only one remote control can be paired per camera. Only the last paired remote control is enabled.

Delete wireless remote controller



Delete a paired ML-L7.

Assign Fn1 button/Assign Fn2 button

Choose the role assigned to the **Fn1** or **Fn2** button on the ML-L7.



Option	Description
[Same as camera  button]	Set the same role as the camera's  button.
[Same as camera MENU button]	Set the same role as the camera's MENU button.
[Same as camera  button]	Set the same role as the camera's  button.
[None]	Pressing the button has no effect.

Conformity marking

MENU button   setup menu

View some of the information related to standards with which the camera complies.

USB power delivery

MENU button   setup menu

Choose whether optional charging AC adapters or computers connected via USB can be used to power the camera (USB power delivery). USB power delivery allows the camera to be used while limiting the drain on the battery.

Option	Description
[Enable]	The camera draws power from connected devices while on. Connected devices will also supply power when the camera is off if Bluetooth upload is in progress or the memory card access lamp is lit.
[Disable]	The camera does not draw power from connected devices at any time.

- Power will only be supplied to the camera when the battery is inserted.
- A USB power delivery icon appears in the shooting display when the camera is powered by an external source.

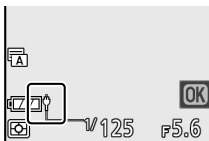

- For more information, see “Charging the camera with the charging AC adapter” (p.565).

✔ Computer USB power delivery

- Before using a computer to supply power to the camera, check that the computer is equipped with a Type C USB connector. Use a UC-E25 USB cable (available separately) to connect the camera to the computer.
- Depending on the model and product specifications, some computers will not supply current to power the camera.

✔ “Power delivery” versus “charging”

The supply of power for camera operations is referred to as “power delivery”, while the term “charging” is used when power is supplied only to charge the camera battery. The conditions under which the power supplied by external devices is used to power the camera or charge the battery are shown below.

Option selected for [USB power delivery]	Camera	External power source used for
[Enable]	On*	Power delivery
	Off	Charging
[Disable]	On*	—
	Off	Charging

* Includes instances in which the power switch is in the “OFF” position but Bluetooth upload is in progress or the memory card access lamp is lit.

Energy saving (photo mode)

MENU button ➡  setup menu

In photo mode, the shooting display will turn off to save power approximately 15 seconds before the standby timer expires.

Option	Description
[Enable]	Enable energy saving. The display refresh rate may drop.

Option	Description
[Disable]	Disable energy saving. Note selecting [Disable] does not stop the shooting display dimming a few seconds before the standby expires.

✓ Energy saving

- Note that even when [Enable] is selected, energy saving will not function:
 - if [No limit] is selected for Custom Setting c3 [Power off delay] > [Standby timer] or if the delay selected is less than 30 seconds,
 - in self-portrait mode,
 - during zoom,
 - while the camera is connected to another device via HDMI, or
 - while the camera is connected to and exchanging data with a computer via USB.
- Selecting [Disable] increases the drain on the battery.

Slot empty release lock

MENU button ➔  setup menu

Choose whether the shutter can be released when no memory card is inserted in the camera.

	Option	Description
LOCK	[Release locked]	The shutter cannot be released when no memory card is inserted.
OK	[Enable release]	The shutter can be released with no memory card inserted. No pictures will be recorded; during playback, the camera displays [Demo].

Save/load menu settings

MENU button ➔  setup menu

Save current camera menu settings to a memory card. You can also load saved settings, allowing menu settings to be shared among cameras of the same model.

- The following settings are saved:

Settings that can be saved and loaded	
PLAYBACK MENU	[Playback display options]
	[Picture review]
	[Rotate tall]
PHOTO SHOOTING MENU	[File naming]
	[Choose image area]
	[Image quality]
	[Image size]
	[RAW recording]
	[ISO sensitivity settings]
	[White balance]
	[Set Picture Control] (Custom Picture Controls are saved as [Auto])
	[Color space]
	[Active D-Lighting]
	[Long exposure NR]
	[High ISO NR]
[Vignette control]	

Settings that can be saved and loaded

PHOTO SHOOTING MENU	[Diffraction compensation]
	[Auto distortion control]
	[Flicker reduction shooting]
	[Metering]
	[Flash control]
	[Flash mode]
	[Flash compensation]
	[Focus mode]
	[AF-area mode]
	[Vibration reduction] (the options available vary with the lens)
[Auto bracketing]	
VIDEO RECORDING MENU	[File naming]
	[Frame size/frame rate]
	[Video quality]
	[Video file type]
	[ISO sensitivity settings]
	[White balance]
	[Set Picture Control] (Custom Picture Controls are saved as [Auto])
	[Active D-Lighting]
	[High ISO NR]
	[Vignette control]

Settings that can be saved and loaded

VIDEO RECORDING MENU	[Diffraction compensation]
	[Auto distortion control]
	[Flicker reduction]
	[Metering]
	[Focus mode]
	[AF-area mode]
	[Vibration reduction] (the options available vary with the lens)
	[Electronic VR]
	[Microphone sensitivity]
	[Attenuator]
	[Frequency response]
[Wind noise reduction]	
[Timecode] (excepting [Timecode origin])	
CUSTOM SETTINGS MENU	All items
SETUP MENU	[Language]
	[Time zone and date] (except [Date and time])
	[Limit monitor mode selection]
	[Information display]
	[Non-CPU lens data]
	[Save focus position]
	[Image comment]

Settings that can be saved and loaded

SETUP MENU	[Copyright information]
	[Beep options]
	[Touch controls]
	[Self-portrait mode]
	[HDMI]
	[USB power delivery]
	[Energy saving (photo mode)]
	[Slot empty release lock]

Save menu settings

Save settings to a memory card. If the card is full, an error will be displayed and settings will not be saved. Saved settings can only be used with other cameras of the same model.

Load menu settings

Load saved settings from a memory card. Note that [**Load menu settings**] is available only when a memory card containing saved settings is inserted.

Saved settings

Settings are saved to files named "NCSET****". "****" is an identifier that varies from camera to camera. The camera will not be able to load settings if the file name is changed.

Reset all settings

MENU button ➔  setup menu

Reset all settings except [**Language**] and [**Time zone and date**] to their default values. Copyright information and other user-generated entries are also reset. Once reset, settings cannot be restored.

We recommend that you save settings using the [**Save/load menu settings**] item in the setup menu before performing a reset.

Firmware version

MENU button ➔  setup menu

View the current camera firmware version. If new firmware for the camera is on a memory card, you can update the firmware.

Updating the firmware

To update the camera firmware, you can use either a computer or smart device.

- **When using a computer:** You can confirm if there is a new firmware version at the Nikon Download Center. For the update procedure, see the firmware download website.
 - **When using a smart device:** If the camera and your smart device are already paired using the SnapBridge app, the app will notify you when there is new firmware for your camera. You can then transfer the firmware to the memory card in the camera by using your smart device. For the update procedure, see the SnapBridge app online help. The timing of the notification may differ from the timing at which the update is released on the Nikon Download Center.
-





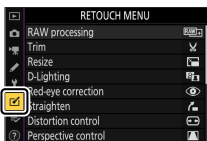







The retouch menu: Creating retouched copies

To view the retouch menu, select the  tab in the camera menus.



The items in the retouch menu are used to trim or retouch existing pictures.

- The retouch menu is grayed out if a memory card is not inserted in the camera or if a memory card does not contain pictures.
- Retouched copies are saved to new files, separate from the original pictures.
- The retouch menu contains the following items:

Item			Item		
	[RAW processing]	428		[Distortion control]	438
	[Trim]	431		[Perspective control]	439
	[Resize]	432		[Monochrome]	440
	[D-Lighting]	436		[Overlay pictures]*	441
	[Red-eye correction]	437		[Trim video]	448
	[Straighten]	438			

* Not displayed when [Retouch] is selected in the playback  menu.

Creating retouched copies

1 Select an item in the retouch menu.

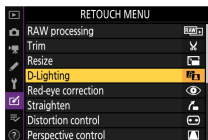

Press or to highlight an item, to select.

2 Select a picture.



- Highlight a picture using the multi selector.
- To view the highlighted picture zoomed in, press and hold the button.
- Press to select the highlighted picture.

3 Select retouch options.

- For more information, see the section for the selected item.
- To exit without creating a retouched copy, press **MENU**. The retouch menu will be displayed.

4 Create a retouched copy.



- Press **OK** to create a retouched copy.
- Retouched copies are indicated by a  icon.

✔ Retouching the current picture

To create a retouched copy of the current image, press **i** and select **[Retouch]**.

✔ Retouch

- The camera may not be able to display or retouch images that were taken or retouched using other cameras or that have been retouched on a computer.
- If no actions are performed for a brief period, the display will turn off and any unsaved changes will be lost. To increase the time the display remains on, choose a longer menu display time using Custom Setting c3 **[Power off delay]** > **[Menus]**.

✔ Retouching copies

- Most items can be applied to copies created using other retouch options, although multiple edits may result in reduced image quality or faded colors.
- With the exception of **[Trim video]**, each item can be applied only once.
- Some items may be unavailable depending on the items used to create the copy.
- Items that cannot be applied to the current image are grayed out and unavailable.

✔ Image quality

- Copies created from RAW pictures are saved at an **[Image quality]** of **[JPEG fine]**.
- Copies created from JPEG pictures are the same quality as the original.
- In the case of dual-format pictures recorded to the same memory card at image-quality settings of RAW + JPEG, only the RAW copy will be retouched.

✔ Image size

Except in the case of copies created with **[RAW processing]**, **[Trim]**, and **[Resize]**, copies are the same size as the original.

RAW processing: Converting RAW to JPEG

MENU button ➔  retouch menu

The process of converting RAW images to other formats such as JPEG is referred to as “RAW processing”. JPEG copies of RAW pictures can be created on the camera as described below.

1 Select [RAW processing] in the retouch menu.

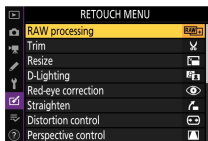

Highlight [**RAW processing**] and press .

2 Choose how pictures are selected.

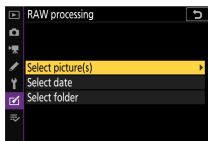

Option	Description
[Select picture(s)]	Create JPEG copies of selected RAW images. Multiple RAW images can be selected.
[Select date]	Create JPEG copies of all RAW pictures taken on selected dates.
[Select folder]	Create JPEG copies of all RAW pictures in a selected folder.

3 Select photographs.

If you chose [Select picture(s)]:



- Highlight pictures using the multi selector.
- To view the highlighted picture zoomed in, press and hold the button.
- To select the highlighted picture, press the (?) button. Selected pictures are marked by a . To deselect the current picture, press the (?) button again; the will no longer be displayed. All images will be processed using the same settings.
- Press to proceed once selection is complete.

If you chose [Select date]:

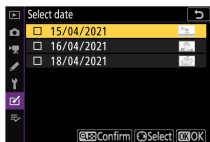

- Highlight dates using the multi selector and press to select () or deselect ()
- All images taken on dates marked with a check () will be processed using the same settings.
- Press to proceed once selection is complete.

If you chose [Select folder]:

Highlight a folder and press to select; all images in the selected folder will be processed using the same settings.

4 Choose settings for the JPEG copies.

- The settings in effect when the photograph was taken appear below a preview.
- To use the setting in effect when the photograph was taken, if applicable, select **[Original]**.

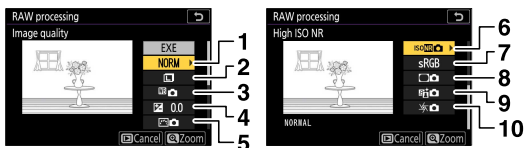

1	Image quality (☐244)
2	Image size (☐244)
3	White balance (☐248)
4	Exposure compensation (☐139)
5	Set Picture Control (☐255)

6	High ISO NR (☐263)
7	Color space (☐262)
8	Vignette control (☐264)
9	Active D-Lighting (☐164)
10	Diffraction compensation (☐264)

- To exit without copying the photographs, press the button.

5 Copy the photographs.



- Highlight [EXE] and press \odot to create JPEG copies of the selected photographs.
- If multiple photos are selected, a confirmation dialog will be displayed after you highlight [EXE] and press \odot ; highlight [Yes] and press \odot to create JPEG copies of the selected photos.
- To cancel the operation before all copies have been created, press the MENU button; when a confirmation dialog is displayed, highlight [Yes] and press \odot .

✓ RAW processing

- RAW processing is available only with RAW images created with this camera. RAW images created with other cameras or images in formats other than RAW cannot be selected.
- [Exposure compensation] can only be set to values between -2 and +2 EV.

Trim

MENU button ➔ retouch menu

Create a cropped copy of the selected photograph. The photograph is displayed with the selected crop shown in yellow; create a cropped copy as described below.

To	Description
Size the crop	Press \odot or \odot (?) to choose the crop size.

To	Description
Change the crop aspect ratio	Rotate the main command dial to choose the aspect ratio.
Position the crop	Use the multi selector to position the crop.
Save the crop	Press OK to save the current crop as a separate file.

✔ Cropped pictures

- Depending on the size of the cropped copy, playback zoom may not be available when cropped copies are displayed.
- The crop size appears at upper left in the crop display. The size of the copy varies with crop size and aspect ratio.



Resize

MENU button ➡ retouch menu

Create small copies of selected photographs.

Resizing multiple images

If you accessed the retouch menu via the MENU button, you can resize multiple selected images.



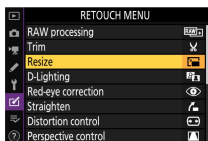

1 Select [Resize] in the retouch menu.

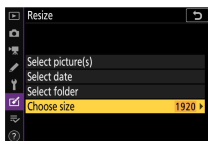

Highlight [**Resize**] and press .

2 Choose a size.



- Highlight [**Choose size**] and press .
- Highlight the desired size (length in pixels) using  and  and press .

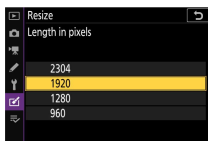

3 Choose how pictures are selected.

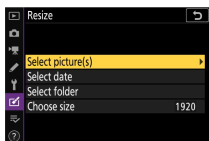







Option	Description
[Select picture(s)]	Resize selected pictures. Multiple pictures can be selected.
[Select date]	Resize all pictures taken on selected dates.
[Select folder]	Resize all pictures in a selected folder.

4 Choose pictures.





If you chose [Select picture(s)]:

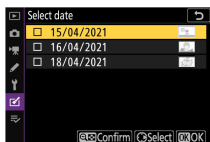

- Highlight pictures using the multi selector.
- To view the highlighted picture zoomed in, press and hold the  button.
- To select the highlighted picture, press the  (?). Selected pictures are indicated by a  icon. To deselect the current picture, press the  (?) button again; the  will no longer be displayed. The selected pictures will all be copied at the size selected in Step 3.
- Press  to proceed once selection is complete.

If you chose [Select date]:



- Highlight dates using the multi selector and press  to select () or deselect ()
- All pictures taken on dates marked with a check () will be copied at the size selected in Step 3.
- Press  to proceed once selection is complete.

If you chose [Select folder]:

Highlight a folder and press  to select; all pictures in the selected folder will be copied at the size selected in Step 3.

5 Save the resized copies.

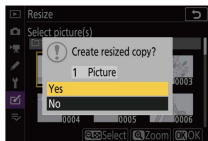

- A confirmation dialog will be displayed; highlight **[Yes]** and press **OK** to save the resized copies.
- To cancel the operation before all copies have been created, press the **MENU** button; when a confirmation dialog is displayed, highlight **[Yes]** and press **OK**.

Resize

Depending on the copy size, playback zoom may not be available when resized copies are displayed.

D-Lighting

MENU button ➔ retouch menu

D-Lighting brightens shadows. It is ideal for dark or backlit photographs.



Before

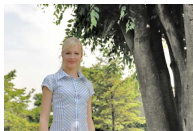

After

The edit display shows before and after images.

- Press or to choose the amount of correction performed. The effect can be previewed in the edit display.



- Press to save the retouched copy.

Red-eye correction

MENU button retouch menu

Correct “red-eye” caused by light from the flash reflecting from the retinas of portrait subjects.

- Red-eye correction is available only with photographs taken using a flash.
- Red-eye that cannot be detected by the camera will not be corrected.
- Press to save the retouched copy.

Red-eye correction



- Note the following:
 - Red-eye correction may not always produce the expected results.
 - In very rare circumstances, red-eye correction may be applied to portions of the image that are not affected by red-eye.
- Check the preview thoroughly before proceeding.

Straighten

MENU button ➔  retouch menu

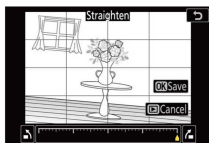
Rotate pictures by up to $\pm 5^\circ$ in increments of approximately 0.25° .



- The effect can be previewed in the edit display.
- The greater the rotation, the more will be trimmed from the edges.
- Press  or  to choose the amount of straightening performed.
- Press  to save the retouched copy.

Distortion control

MENU button ➔  retouch menu

Create copies with reduced peripheral distortion; this can reduce barrel distortion in pictures taken with wide-angle lenses or pin-cushion distortion in pictures taken with telephoto lenses. Select [**Auto**] to let the camera correct distortion automatically and then make fine adjustments using the multi selector. Select [**Manual**] to reduce distortion manually.

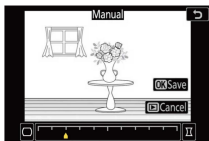

- The effect can be previewed in the edit display.
- Note that [**Manual**] must be used with copies created using the [**Auto**] option and with photos taken using the [**Auto distortion**]

control] option in the photo shooting menu. Manual distortion control cannot be further applied to copies created using [**Manual**].

- Press to reduce pincushion distortion, to reduce barrel distortion.
- Press to save the retouched copy.

✔ Distortion control

Note that greater amounts of distortion control result in more of the edges being cropped out.

Perspective control

MENU button ➔ retouch menu

Create copies that reduce the effects of perspective in photos taken looking up from the base of a tall object.



- The effect can be previewed in the edit display.
- Note that greater amounts of perspective control result in more of the edges being cropped out.
- Use the multi selector (, , , or) to adjust perspective.

- Press **OK** to save the retouched copy.



Before



After

Monochrome

MENU button ➔ retouch menu

Copy photographs in monochrome. **[Monochrome]** gives you a choice of the following monochrome tints:

Option	Description
[Black-and-white]	Copy photographs in black-and-white.
[Sepia]	Copy photographs in sepia.
[Cyanotype]	Copy photographs in blue-and-white monochrome.

- The effect can be previewed in the edit display.

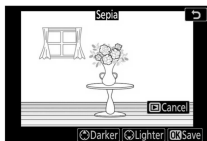

- In the case of **[Sepia]** or **[Cyanotype]**, color saturation can be adjusted using the multi selector. Press **▲** to increase, **▼** to decrease. The changes are reflected in the preview.

- Press **OK** to save the retouched copy.

Overlay pictures

MENU button ➔  retouch menu

Picture overlay combines existing photographs to create a single picture that is saved separately from the originals. One RAW image can be overlaid on another using additive blending (**[Add]**), or multiple images can be combined using **[Lighten]** or **[Darken]**.

Add

Overlay two RAW images to create a single new JPEG copy.



1 Select **[Overlay pictures]** in the retouch menu.

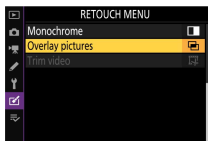

Highlight **[Overlay pictures]** and press **OK**.

2 Select [Add].

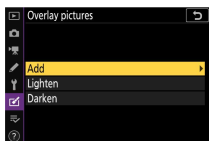

Highlight **[Add]** and press **⌘** to display picture overlay options with **[Picture 1]** highlighted.



3 Highlight the first image.

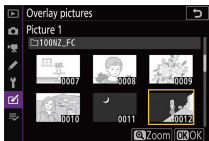

- Press **⌘** to display a picture-selection dialog listing only RAW images, where you can use the multi selector to highlight the first photograph in the overlay.
- To view the highlighted picture zoomed in, press and hold the **⌘** button.

4 Select the first image.



Press **OK** to select the highlighted photograph and return to the preview display; the selected image will appear as **[Picture 1]**.

5 Select the second image.



Press **OK** and select **[Picture 2]**, then select the second photo as described in Steps 3 and 4.

6 Adjust gain.



- The overlay of **[Picture 1]** and **[Picture 2]** can be previewed in the “Preview” column. Highlight **[Picture 1]** or **[Picture 2]** and optimize exposure for the overlay by pressing **⬆** or **⬇** to adjust gain.
- Choose from values between 0.1 and 2.0 in increments of 0.1.
- The effects are relative to the default value of 1.0 (no gain). For example, selecting 0.5 halves gain.

7 Select the "Preview" column.

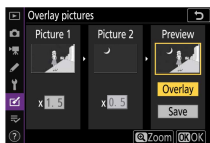

- Press **←** or **→** to place the cursor in the "Preview" column.
- To proceed without previewing the overlay, highlight **[Save]** and press **OK**.

8 Preview the overlay.



- To preview the overlay, highlight **[Overlay]** and press **OK**.
- To select new photos or adjust gain, press **ESC (?)**. You will be returned to Step 6.

9 Save the overlay.



Press **OK** while the preview is displayed to save the overlay and display the resulting image.

✔ [Add]

- Colors and brightness in the preview may differ from the final image.
 - Picture overlay is available only with RAW images created with this camera. Images created with other cameras or in other formats cannot be selected.
 - The overlay is saved at an **[Image quality]** of **[JPEG fine]**.
 - RAW pictures can be combined only if they were created with the same options selected for:
 - **[Choose image area]**
 - **[RAW recording]**
 - The overlay has the same photo info (including date of recording, metering, shutter speed, aperture, shooting mode, exposure compensation, focal length, and image orientation) and values for white balance and Picture Control as the photograph selected for **[Picture 1]**. Copyright information, however, is not copied to the new image. The comment is similarly not copied; instead, the comment currently active on the camera, if any, is appended.
-

Lighten and darken

The camera compares multiple selected pictures and selects only the brightest or darkest pixels at each point in the image to create a single new JPEG copy.

1 Select [Lighten] or [Darken].

After selecting [**Overlay pictures**] in the retouch menu, highlight either [**Lighten**] or [**Darken**] and press .

- [**Lighten**]: The camera compares the pixels in each picture and uses only the brightest.



- [**Darken**]: The camera compares the pixels in each picture and uses only the darkest.









2 Choose how pictures are selected.







Option	Description
[Select individual pictures]	Select pictures for the overlay one-by-one.
[Select consecutive pictures]	Select two pictures; the overlay will include the two pictures and all images between them.
[Select folder]	The overlay will include all pictures in the selected folder.

3 Select pictures.

If you chose [Select individual pictures]:

- Highlight pictures using the multi selector.
- To view the highlighted picture zoomed in, press and hold the  button.
- To select the highlighted picture, press the  (?) button. Selected pictures are marked by a  icon. To deselect the current picture, press the  (?) button again; the  icon will no longer be displayed. The selected pictures will be combined using the option selected in Step 1.
- Press  to proceed once selection is complete.

If you chose [Select consecutive pictures]:

- All pictures in a range chosen using the multi selector will be combined using the option selected in Step 1.
 - Use  (?) to select the first and last pictures in the desired range.
 - The first and last pictures are indicated by  icons and the pictures between them by  icons.
 - You can alter your selection by using the multi selector to highlight different pictures to serve as the first or last frame. Press the  () button to move the start or end point in a range.
- To view the highlighted picture zoomed in, press and hold the  button.
- Press  to proceed once selection is complete.

If you chose [Select folder]:

Highlight the desired folder and press  to overlay all pictures in the folder using the option selected in Step 1.

4 Save the overlay.

- A confirmation dialog will be displayed; highlight [**Yes**] and press **OK** to save the overlay and display the resulting picture.
- To interrupt the process and display a confirmation dialog before the operation is complete, press the **MENU** button; to save the current overlay “as is” without adding the remaining pictures, highlight [**Save and exit**] and press **OK**. To exit without creating an overlay, highlight [**Discard and exit**] and press **OK**.

✔ [Lighten]/[Darken]

- The overlay will include only pictures created with this camera. Pictures created with other cameras cannot be selected.
- The overlay will include only pictures created with the same options selected for:
 - [**Choose image area**]
 - [**Image size**]
- The image quality setting for the completed overlay is that of the highest quality picture it contains.
- Overlays that include RAW pictures will be saved at an image quality of [**JPEG fine**].
- The size of overlays that include both RAW and JPEG images is determined by the JPEG picture.

Trim video

MENU button ➡  retouch menu

Create a copy from which unwanted footage has been removed (☐204).

☰ My Menu/⌚ Recent settings

To view [MY MENU], select the ☰ tab in the camera menus.

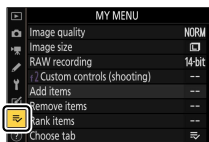

☰ My Menu: Creating a custom menu

My Menu can be used to create and edit a customized list of up to 20 items from the playback, photo shooting, video recording, Custom Settings, setup, and retouch menus. Options can be added, deleted, and reordered as described below.

■ Adding items to My Menu

1 Select [Add items] in [☰ MY MENU].

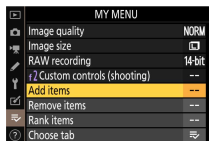

Highlight [Add items] and press ⌚.

2 Select a menu.

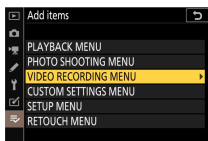

Highlight the name of the menu containing the item you wish to add and press **→**.

3 Select an item.

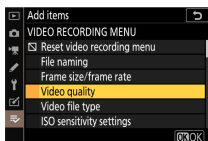

Highlight the desired menu item and press **OK**.

4 Position the new item.

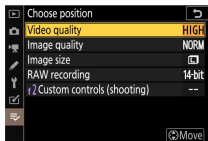

Press **↑** or **↓** to position the new item and press **OK** to add it to My Menu.

5 Add more items.

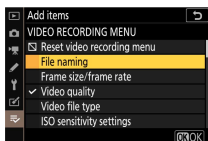

- The items currently displayed in My Menu are indicated by a check mark (✓).
- Items indicated by a □ icon cannot be selected.
- Repeat Steps 1–4 to select additional items.

Removing items from My Menu

1 Select [Remove items] in [MY MENU].

Highlight [Remove items] and press .

2 Select items.

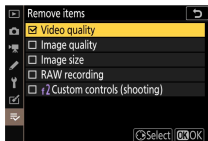

- Highlight items and press to select (✓) or deselect.
- Continue until all the items you wish to remove are selected (✓).

3 Remove the selected items.

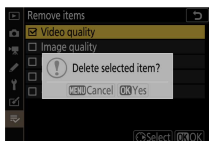

Press **OK**; a confirmation dialog will be displayed. Press **OK** again to remove the selected items.

✓ Removing items while in My Menu

Items can also be removed by highlighting them in [**MY MENU**] and pressing the **Trash** button; a confirmation dialog will be displayed. Press the **Trash** button again to remove the selected item.

Reordering items in My Menu

1 Select [Rank items] in [**MY MENU**].

Highlight [Rank items] and press **OK**.

2 Select an item.

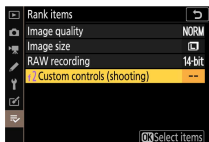

Highlight the item you wish to move and press **OK**.

3 Position the item.

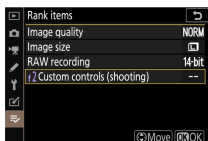

- Press or to move the item up or down in My Menu and press .
- Repeat Steps 2–3 to reposition additional items.

4 Exit to MY MENU.

Press the **MENU** button to return to **MY MENU**.

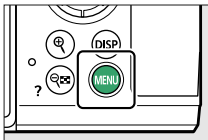

■ ■ Displaying [RECENT SETTINGS]

1 Select [Choose tab] in [⇨ MY MENU].

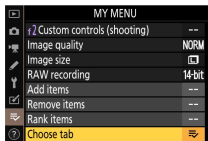

Highlight [Choose tab] and press ⏪.

2 Select [⇨ RECENT SETTINGS].

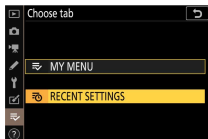

- Highlight [⇨ RECENT SETTINGS] in the [Choose tab] menu and press ⏪.
- The name of the menu will change from [MY MENU] to [RECENT SETTINGS].



Recent settings: Accessing recently-used settings

How items are added to [RECENT SETTINGS]

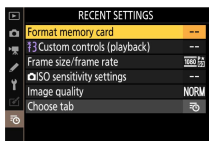

Menu items are added to the top of the [RECENT SETTINGS] menu as they are used. The twenty most recently-used settings are listed.



Removing items from the recent settings menu

To remove an item from the [RECENT SETTINGS] menu, highlight it and press the  button; a confirmation dialog will be displayed. Press  button again to remove the selected item.

Displaying My Menu

Selecting [Choose tab] in the [RECENT SETTINGS] menu displays the items shown in Step 2 of “Displaying [RECENT SETTINGS]” ([□454](#)). Highlight  MY MENU] and press  to view My Menu.

Establishing wireless connections to computers or smart devices

Network options

The camera can:

- connect to computers via Wi-Fi (☐457) or

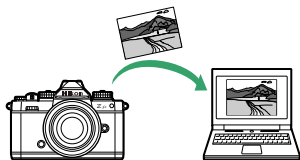

- establish wireless connections to smartphones or tablets (smart devices; ☐479)

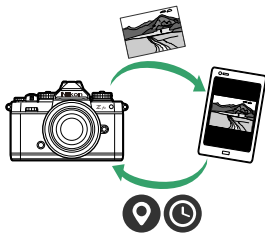

Connecting to computers via Wi-Fi

What Wi-Fi can do for you

Connect using the camera's built-in Wi-Fi to upload selected pictures to a computer.

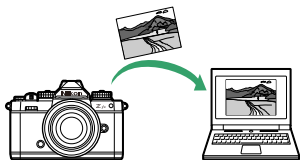

The Wireless Transmitter Utility

Before you will be able to upload images via Wi-Fi, you will need to pair the camera with the computer using Nikon's Wireless Transmitter Utility software.

- Once the devices are paired, you will be able to connect to the computer from the camera.
- The Wireless Transmitter Utility is available for download from the Nikon Download Center. Be sure to download the latest version after reading the release notes and system requirements.

<https://downloadcenter.nikonimglib.com/>

Infrastructure and access-point modes

Either of the following two methods can be used to establish wireless connections between the camera and a computer.

■ ■ Direct wireless connection (access-point mode)

The camera and computer connect via direct wireless link. The camera acts as a wireless LAN access point, letting you connect when working

outdoors and in other situations in which the computer is not already connected to a wireless network and eliminating the need for complicated adjustments to settings. The computer cannot connect to the Internet while connected to the camera.



- To create a new host profile, select [**Direct connection to computer**] in the connection wizard.

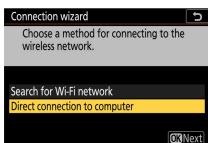

Infrastructure mode

The camera connects to a computer on an existing network (including home networks) via a wireless router. The computer can still connect to the Internet while connected to the camera.

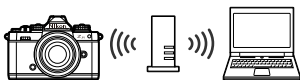

- To create a new network profile, select [**Search for Wi-Fi network**] in the connection wizard.

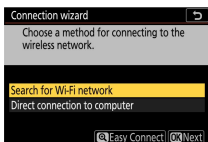

✔ Infrastructure mode

- This guide assumes you are connecting via an existing wireless network.
 - Connection to computers beyond the local area network is not supported. You can connect only to computers on the same network.
-

Connecting in access-point mode

- 1** Select [Connect to computer] in the camera setup menu, then highlight [Network settings] and press **▶**.

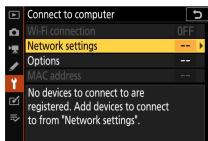

- 2** Highlight [Create profile] and press **OK**.

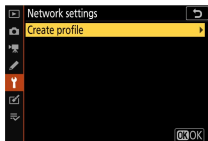

3 Highlight [Direct connection to computer] and press **OK**.

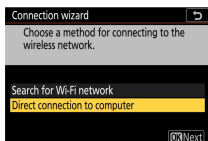

The camera SSID and encryption key will be displayed.



4 Establish a connection to the camera.

Windows:



- Click the wireless LAN icon in the taskbar.
- Select the SSID displayed by the camera in Step 3.
- When prompted to enter the network security key, enter the encryption key displayed by the camera in Step 3. The computer will initiate a connection to the camera.

macOS:



- Click the wireless LAN icon in the menu bar.
- Select the SSID displayed by the camera in Step 3.

- When prompted to enter the network security key, enter the encryption key displayed by the camera in Step 3. The computer will initiate a connection to the camera.

5 Start pairing.



When prompted, launch the Wireless Transmitter Utility on the computer.

6 Select the camera in the Wireless Transmitter Utility.

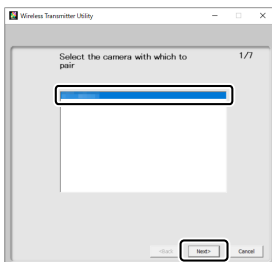

Select the name displayed by the camera in Step 5 and click **[Next]**.

7 In the Wireless Transmitter Utility, enter the authentication code displayed by the camera.

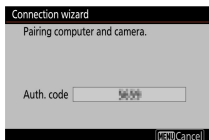

- The camera will display an authentication code.
- Enter the authentication code in the dialog displayed by the Wireless Transmitter Utility and click **[Next]**.

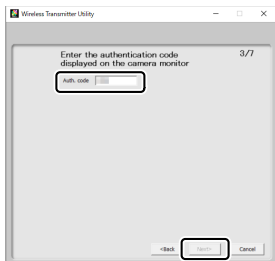

8 Complete the pairing process.



- When the camera displays a message stating that pairing is complete, press **OK**.
- In the Wireless Transmitter Utility, click **[Next]**; you will be prompted to choose a destination folder. For more information, see online help for the Wireless Transmitter Utility.

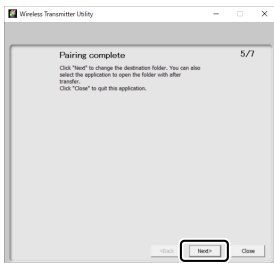

- A wireless connection will be established between the camera and computer when pairing is complete.

9 Check the connection.

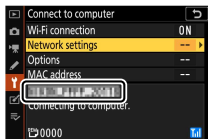

When a connection is established, the network SSID will be displayed in green in the camera **[Connect to computer]** menu.

- If the camera SSID is not displayed in green, connect to the camera via the wireless network list on your computer.

A wireless connection has now been established between the camera and the computer.

Pictures taken with the camera can be uploaded to the computer as described in “Uploading pictures” (473).

Connecting in infrastructure mode

- 1 Select **[Connect to computer]** in the camera setup menu, then highlight **[Network settings]** and press **▶**.

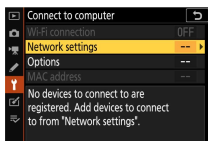

- 2 Highlight **[Create profile]** and press **OK**.

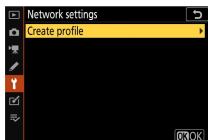

3 Highlight [Search for Wi-Fi network] and press **OK**.

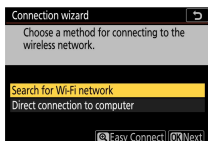

The camera will search for networks currently active in the vicinity and list them by name (SSID).

✓ [Easy Connect]

- To connect without entering an SSID or encryption key, press **OK** in Step 3. Next, press **OK** and choose from the following options:

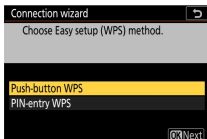

Option	Description
[Push-button WPS]	For routers that support push-button WPS. Press the WPS button on the router and then press the camera OK button to connect.
[PIN-entry WPS]	The camera will display a PIN. Using a computer, enter the PIN on the router. For more information, see the documentation provided with the router.

- After connecting, proceed to Step 6.

4 Choose a network.

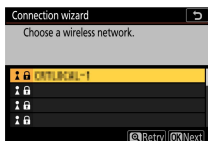

- Highlight a network SSID and press **OK**.
- Encrypted networks are indicated by a **lock** icon. If the selected network is encrypted (**lock**), you will be prompted to enter the encryption key. If the network is not encrypted, proceed to Step 6.
- If the desired network is not displayed, press **Search** to search again.

✓ Hidden SSIDs

Networks with hidden SSIDs are indicated by blank entries in the network list.

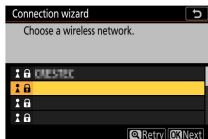

- To connect to a network with a hidden SSID, highlight a blank entry and press **OK**. Next, press **OK**; the camera will prompt you to provide an SSID.
- Enter the network name and press **Search**. Press **Search** again; the camera will now prompt you to enter the encryption key.

5 Enter the encryption key.

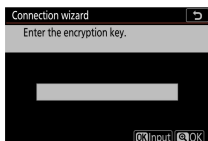

- Press **OK** and enter the encryption key for the wireless router.
- For more information, see the documentation for the wireless router.



- Press **OK** when entry is complete.
- Press **OK** again to initiate the connection. A message will be displayed for a few seconds when the connection is established.



6 Obtain or select an IP address.

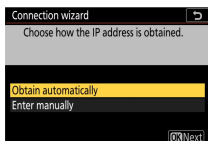

- Highlight one of the following options and press **↵**.

Option	Description
[Obtain automatically]	Select this option if the network is configured to supply the IP address automatically. A “configuration complete” message will be displayed once an IP address has been assigned.
[Enter manually]	Enter the IP address and sub-net mask manually. <ul style="list-style-type: none">• Rotate the main command dial to highlight segments.• Press ← or → to change the highlighted segment and press ↵ to save changes.• Next, press ↵; a “configuration complete” message will be displayed. Press ↵ again to display the sub-net mask.• Press ← or → to edit the sub-net mask and press ↵; a “configuration complete” message will be displayed.

- Press **↵** to proceed when the “configuration complete” message is displayed.

7 Start pairing.



When prompted, launch the Wireless Transmitter Utility on the computer.

8 Select the camera in the Wireless Transmitter Utility.

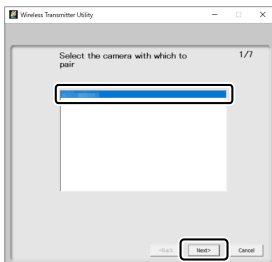

Select the name displayed by the camera in Step 7 and click **[Next]**.

9 In the Wireless Transmitter Utility, enter the authentication code displayed by the camera.

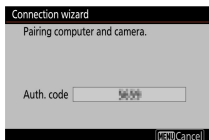

- The camera will display an authentication code.
- Enter the authentication code in the dialog displayed by the Wireless Transmitter Utility and click **[Next]**.

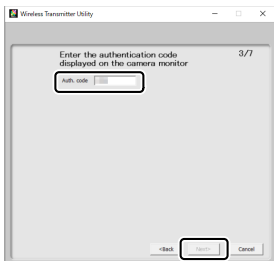

10 Complete the pairing process.



- When the camera displays a message stating that pairing is complete, press **OK**.
- In the Wireless Transmitter Utility, click **[Next]**; you will be prompted to choose a destination folder. For more information, see online help for the Wireless Transmitter Utility.

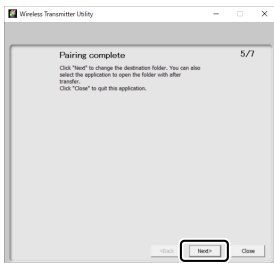

- A wireless connection will be established between the camera and computer when pairing is complete.

11 Check the connection.

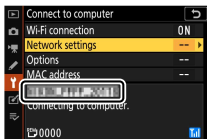

When a connection is established, the network SSID will be displayed in green in the camera [**Connect to computer**] menu.

- If the camera SSID is not displayed in green, connect to the camera via the wireless network list on your computer.

A wireless connection has now been established between the camera and the computer.

Pictures taken with the camera can be uploaded to the computer as described in “Uploading pictures” (□473).

Uploading pictures

Pictures can be selected for upload during playback. They can also be uploaded automatically as they are taken.

✓ Destination folders

By default, images are uploaded to the following folders:

- Windows: \Users*(user name)*\Pictures\Wireless Transmitter Utility
- macOS: /Users/*(user name)*/Pictures/Wireless Transmitter Utility

The destination folder can be selected using the Wireless Transmitter Utility. For more information, see online help for the Wireless Transmitter Utility.

✓ Access point mode

Computers cannot access the Internet while connected to the camera in access point mode. To access the Internet, terminate the connection to the camera and then reconnect to a network with Internet access.

■ Selecting pictures for upload

1 Press the  button on the camera and select full-frame or thumbnail playback.

2 Select a picture and press the  button.

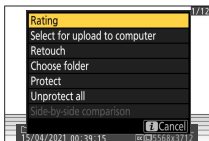

3 Highlight [Select for upload to computer] and press .

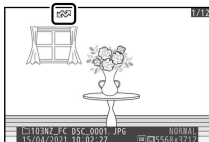

- A white “upload” icon will appear on the picture. If the camera is currently connected to a network, upload will begin immediately and the icon will turn green.
- Otherwise, upload will begin when a connection is established.
- Repeat Steps 2–3 to upload additional pictures.

✓ Removing upload marking

- Repeat Steps 2–3 to remove transfer marking from selected images.
- To remove transfer marking from all pictures, select [**Connect to computer**] > [**Options**] > [**Deselect all?**] in the setup menu.

■ ■ Uploading photos as they are taken

To upload new photos as they are taken, select **[On]** for **[Connect to computer]** > **[Options]** > **[Auto upload]** in the setup menu.

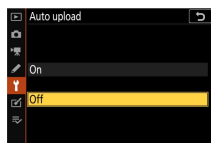

- Upload begins only after the photo has been recorded to the memory card. Be sure a memory card is inserted in the camera.
- Videos and photos taken during video mode are not uploaded automatically when recording is complete. They must instead be uploaded from the playback display.

■ ■ The transfer icon

Upload status is indicated by the transfer icon.



📷 (white): Send

The picture has been selected for automatic upload but upload has not yet begun.

📷 (green): Sending

Upload in progress.

📷 (blue): Sent

Upload complete.

■ The status display

The [Connect to computer] display shows the following:

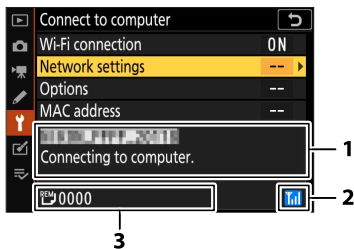

- 1 Status:** The status of the connection to the host. The host name is displayed in green when a connection is established. While files are being transferred, the status display shows "Now sending" preceded by the name of the file being sent. Errors are also displayed here.

- 2 Signal strength:** Wireless signal strength.
- 3 Pictures/time remaining:** The number of pictures remaining and the time needed to send them. The time remaining is an estimate only.

✓ Loss of signal

Wireless transmission may be interrupted if the signal is lost. Upload of pictures with "send" marking can be resumed by turning the camera off and then on again once the signal has been re-established.

Disconnecting and reconnecting

■ ■ Disconnecting

You can end the connection by:

- turning the camera off,
- selecting [**Disable**] for [**Connect to computer**] > [**Wi-Fi connection**] in the setup menu,
- selecting [**Enable**] for [**Airplane mode**] in the setup menu,
- selecting [**Wi-Fi connection**] > [**Close Wi-Fi connection**] in the photo-mode **i** menu, or
- connecting to a smart device via Wi-Fi or Bluetooth.

✓ Access-point mode

An error will occur if the computer's wireless connection is disabled before the camera's. Disable camera Wi-Fi first.

■ ■ Reconnecting

To reconnect to an existing network:

- select [**Enable**] for [**Connect to computer**] > [**Wi-Fi connection**] in the setup menu, or
- select [**Wi-Fi connection**] > [**Establish Wi-Fi connection with computer**] in the photo-mode **i** menu.



✔ **Access-point mode**

Enable camera Wi-Fi before connecting.

✔ **Multiple network profiles**

If the camera has profiles for more than one network, it will reconnect to the last network used. Other networks can be selected using the [**Connect to computer**] > [**Network settings**] option in the setup menu.

Connecting to smart devices

The SnapBridge app

Use the SnapBridge app for wireless connections between the camera and your smartphone or tablet (“smart device”).



- SnapBridge apps can be downloaded from the Apple App Store® or on Google Play™.



- Visit the Nikon website for the latest SnapBridge news.
- Carefully read any license agreements or the like displayed when SnapBridge is launched and only proceed if you are willing to accept them.

What SnapBridge can do for you

The tasks that can be performed using the SnapBridge app are outlined below. For details, see the SnapBridge app online help: <https://nikonimglib.com/snbr/onlinehelp/en/index.html>

■■ Downloading pictures from the camera

Download existing pictures to your smart device. Pictures can be uploaded as they are taken.

■ ■ Remote photography

Control the camera and take pictures from the smart device.

Wireless connections

Use the SnapBridge app for wireless connections between the camera and your smart device. You can connect via either Bluetooth (□480) or Wi-Fi (□483). Connecting using Bluetooth allows pictures to be uploaded automatically as they are taken.

Connecting via Bluetooth (pairing)

Before connecting via Bluetooth for the first time, you will need to pair the camera and smart device.

✓ Before pairing

- Enable Bluetooth on the smart device. For details, see the documentation provided with the device.
 - Ensure that the batteries in the camera and smart device are fully charged to prevent the devices turning off unexpectedly.
 - Check that there is space available on the camera memory card.
-

■ ■ Pairing

Pair the camera and smart device as described below.

- Some operations are performed using the camera, others on the smart device.

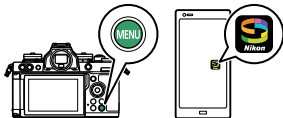

- Additional instructions are available via SnapBridge online help.

-
- 1 Camera: Select [Connect to smart device] > [Pairing (Bluetooth)] in the setup menu, then highlight [Start pairing] and press .**

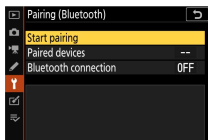

The camera name will be displayed in the monitor.



-
- 2 Smart device: Launch the SnapBridge app and tap [Connect to camera] in the  tab.**

- If this is the first time you have launched the app, you should instead tap **[Connect to camera]** in the welcome display.

-
- 3 Smart device: Follow the on-screen instructions.**

- When prompted, tap the category for your camera and then tap the “pairing” option when prompted to choose the connection type.
- Tap the camera name when prompted.

4 Camera/smart device: After confirming that the camera and smart device display the same authentication code, follow the on-screen instructions on both devices to complete pairing.

- Tap the pairing button on the smart device and press the  button on the camera.
- The camera and smart device will each display a message when pairing is complete. The camera will then automatically exit to the menus.

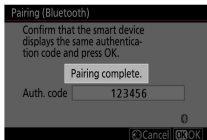

The camera and smart device are now paired.

For information on using the SnapBridge app, see online help.

✔ Pairing error

If you wait too long between pressing the button on the camera and tapping the button on the smart device in Step 4, the device will display an error message and pairing will fail.

- If you are using an Android device, tap **[OK]** and return to Step 1.
- If you are using an iOS device, dismiss the SnapBridge app and check that it is not running in the background, then request iOS to “forget” the camera before returning to Step 1. The request to “forget” the camera is made via the iOS “Settings” app.

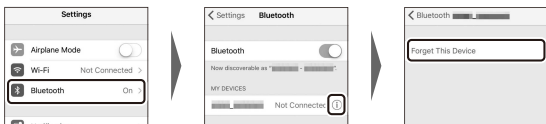

✔ Disabling Bluetooth

To disable Bluetooth, select **[Disable]** for **[Connect to smart device]** > **[Pairing (Bluetooth)]** > **[Bluetooth connection]** in the camera setup menu.

■ ■ Connecting to a previously-paired smart device

Once the smart device has been paired with the camera, you will be able to connect simply by enabling Bluetooth on both the smart device and camera and launching the SnapBridge app.

Connecting via Wi-Fi (Wi-Fi mode)

In Wi-Fi mode, the camera connects directly to the smart device via Wi-Fi, no Bluetooth pairing required.

✔ Before connecting (Wi-Fi mode)

- Enable Wi-Fi on the smart device. For details, see the documentation provided with the device.
 - Ensure that the batteries in the camera and smart device are fully charged to prevent the devices turning off unexpectedly.
 - Check that there is space available on the camera memory card.
-

■ ■ Connecting

Follow the steps below to establish a connection between the camera and smart device in Wi-Fi mode.

- Some operations are performed using the camera, others on the smart device.

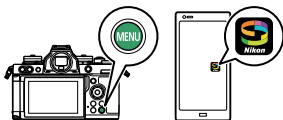

- Additional instructions are available via SnapBridge online help.

1 Smart device: Launch the SnapBridge app, open the tab, tap , and select [Wi-Fi mode].

- If this is the first time you have launched the app, you should instead tap [**Connect to camera**] in the welcome display. When prompted, tap the category for your camera and then tap the “Wi-Fi” option when prompted to choose the connection type.

2 Camera/smart device: Turn the camera on when prompted.

Do not use any of the controls in the app at this point.

- 3** Camera: Select [Connect to smart device] > [Wi-Fi connection] in the setup menu, then highlight [Establish Wi-Fi connection] and press .



The camera SSID and password will be displayed.



Enabling Wi-Fi

You can also enable Wi-Fi by selecting [Wi-Fi connection] > [Establish Wi-Fi conn. with smart device] in the **i** menu for shooting mode.



4 Smart device: Follow the on-screen instructions to establish a Wi-Fi connection.

- On iOS devices, the “Settings” app will launch. Tap [**< Settings**] to open [**Settings**], then scroll up and tap [**Wi-Fi**] (which you’ll find near the top of the settings list) to display Wi-Fi settings.



- In the Wi-Fi settings display, select the camera SSID and enter the password displayed by the camera in Step 3.

5 Smart device: After adjusting device settings as described in Step 4, return to the SnapBridge app.

- After establishing a Wi-Fi connection to the camera, the smart device will display Wi-Fi mode options.
- The camera will display a message stating that the connection is complete.

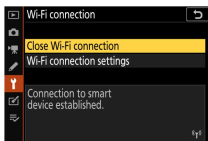

**The camera and smart device are now connected via Wi-Fi.
For information on using the SnapBridge app, see online help.**

✔ Terminating Wi-Fi mode

To end the Wi-Fi connection, tap  in the SnapBridge  tab. When the icon changes to , tap  and select **[Exit Wi-Fi mode.]**

Troubleshooting

Solutions to some common issues are listed below.

- Troubleshooting information for the SnapBridge app can be found in the app's online help, which can be viewed at:
<https://nikonimglib.com/snbr/onlinehelp/en/index.html>
- For information on the Wireless Transmitter Utility, see the utility's online help.

Problem	Solution
The camera displays a TCP/IP error.	Connection settings require adjustment. Check settings for the host computer or wireless router and adjust camera settings appropriately (□411).
The camera displays a "no memory card" error.	The memory card is inserted incorrectly or not at all. Confirm that the memory card is correctly inserted (□75).
Upload is interrupted and fails to resume.	Upload will resume if the camera is turned off and then on again (□473).
The connection is unreliable.	If [Auto] is selected for [Channel] when you are connecting to a smart device, choose [Manual] and select the channel manually (□410).
	If the camera is connected to a computer in infrastructure mode, check that the router is set to a channel between 1 and 8 (□411).

Cabled connections to computers and HDMI devices

Connecting to computers via USB

The camera can be connected to computers featuring USB connectors. To connect, the optional USB cable (□563) is required. This item must be purchased separately. You can then use Nikon NX Studio software to copy pictures to the computer for viewing and editing. For information on establishing wireless connections to computers, see “Connecting to computers via Wi-Fi” in “Establishing wireless connections to computers or smart devices” (□457).

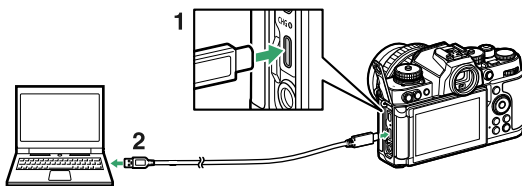

- 1 USB Type-C connector for connection to camera
- 2 USB connector* for connection to computer

* Choose a cable with a connector that matches the connector on the computer.

Installing NX Studio

You will need an Internet connection when installing NX Studio. Visit the Nikon website for system requirements and other information.

- Download the latest NX Studio installer from the website below and follow the on-screen instructions to complete installation.
<https://downloadcenter.nikonimglib.com/>
- Note that you may be unable to download pictures from the camera using earlier versions of NX Studio.

Copying pictures to a computer using NX Studio

See online help for detailed instructions.

1 Connect the camera to the computer.

After turning the camera off and ensuring that a memory card is inserted, connect the USB cable as shown. You also have the option of inserting the camera memory card into the computer's card slot (if available) or a third-party card reader. Before doing so, check that the card is compatible with the reader or card slot.

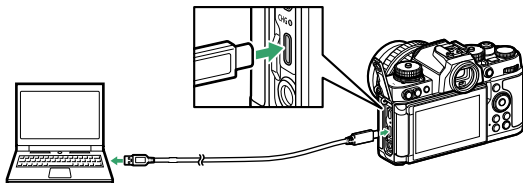

2 Turn the camera on.

- The Nikon Transfer 2 component of NX Studio will start. Nikon Transfer 2 is image transfer software that is installed when you install NX Studio.
- If a message is displayed prompting you to choose a program, select Nikon Transfer 2.
- If Nikon Transfer 2 does not start automatically, launch NX Studio and click the “Import” icon.

3 Click [Start Transfer].

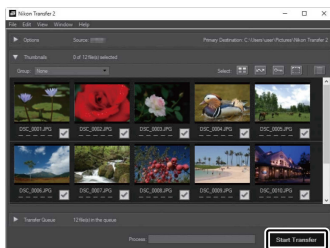

Pictures on the memory card will be copied to the computer.

4 Turn the camera off.

Disconnect the USB cable when transfer is complete.

✔ Windows 10 and Windows 8.1

Windows 10 and Windows 8.1 may display an AutoPlay prompt when the camera is connected.



Click the dialog and then click **[Nikon Transfer 2]** to select Nikon Transfer 2.

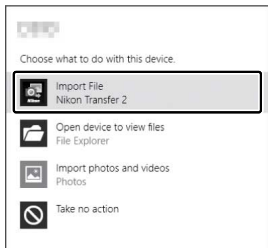

✔ macOS

If Nikon Transfer 2 does not start automatically, confirm that the camera is connected and then launch Image Capture (an application that comes with macOS) and select Nikon Transfer 2 as the application that opens when the camera is detected.

✔ Transferring videos

Do not attempt to transfer videos from the memory card while it is inserted in a camera of a different make or model. Doing so could result in the videos being deleted without being transferred.

✔ Connecting to computers

- Do not turn the camera off or disconnect the USB cable while transfer is in progress.
- Do not use force or attempt to insert the connectors at an angle. Be sure also to keep the connectors straight when disconnecting the cable.
- Always turn the camera off before connecting or disconnecting a cable.

- To ensure that data transfer is not interrupted, be sure the camera battery is fully charged.

USB hubs

Connect the camera directly to the computer; do not connect the cable via a USB hub or keyboard.

Connecting to HDMI devices

The camera can be connected to TVs, recorders, and other devices featuring HDMI connectors. Use a third-party HDMI cable (Type D). These items must be purchased separately. Always turn the camera off before connecting or disconnecting an HDMI cable.

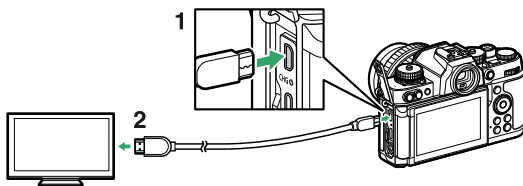

1 HDMI connector for connection to camera

2 HDMI connector for connection to external device*

* Choose a cable with a connector that matches the connector on the HDMI device.

TVs

- After tuning the TV to the HDMI input channel, turn the camera on and press the  button to view pictures on the television screen.
- Audio playback volume can be adjusted using the controls on the TV. Camera controls cannot be used.
- If the camera is paired with a smart device running the SnapBridge app, the device can be used to control playback remotely while the camera is connected to a TV. See the SnapBridge app online help for details.

Recorders

The camera can record video directly to connected HDMI recorders. Use the **[HDMI]** item in the setup menu to adjust settings for HDMI output.

Some recorders will start and stop recording in response to camera controls.



■ ■ Output resolution

Choose the format for images output to the HDMI device. If [**Auto**] is selected, the camera will automatically choose the appropriate format.

■ ■ Advanced

Adjust settings for connection to the HDMI device.

Option	Description
[Output range]	<p>The RGB video signal input range varies with the HDMI device. [Auto], which matches the output range to the HDMI device, is recommended in most situations. If the camera is unable to determine the correct RGB video signal output range for the HDMI device, you can choose from the following options:</p> <ul style="list-style-type: none">• [Limited range]: For devices with an RGB video signal input range of 16 to 235. Choose this option if you notice a loss of detail in shadows.• [Full range]: For devices with an RGB video signal input range of 0 to 255. Choose this option if you notice that shadows are “washed out” or too bright.

Option	Description
<p>[External recording control]</p>	<p>Choosing [On] allows camera controls to be used to start and stop recording when the camera is connected via HDMI to a third-party recorder that supports the Atomos Open Protocol.</p> <ul style="list-style-type: none"> • External recording control is available with Atomos SHOGUN, NINJA, and SUMO-series Monitor recorders. For more information on device features and operation, contact the manufacturer or refer to the documentation provided with the recorder. • The camera display will turn off automatically when the time selected for Custom Setting c3 [Power off delay] > [Standby timer] expires, ending HDMI output. When recording videos to an external device, select [Standby timer] and choose [No limit] or a time longer than the anticipated recording time. • An icon will be displayed in the camera monitor when [On] is selected: STBY is displayed during standby, REC during video recording. During recording, check the recorder and recorder display to ensure that footage is being saved to the device. • Note that selecting [On] may disrupt the footage output to the device.

✔ No HDMI output

If the video frame size and rate is set to 1920×1080 120p, 1920×1080 100p, or 1920×1080 slow-motion, HDMI output is not available.

✔ Zoom

If you zoom in on the display during video recording, the video being recorded will be displayed at 1:1 (100%) on HDMI devices. During video recording standby, if you set the frame size to 3840 × 2160 and zoom in on the display, the display on the HDMI devices will be at a frame size of 1920 × 1080.

On-Camera flash photography

“On-camera” versus “remote”

You can take pictures using an optional flash unit mounted on the camera accessory shoe or one or more remote flash units.

- When using a flash, select **[Off]** for **[Silent photography]** in the photo shooting menu.

Camera-mounted flash units

Take pictures using a flash unit mounted on the camera. See the following pages for more information.

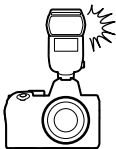

Remote flash photography

Take pictures with one or more remote flash units using wireless flash control (Advanced Wireless Lighting, or AWL). For more information, see “Remote flash photography” (□508).

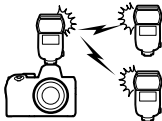

Using an on-camera flash

- 1 Mount a flash unit on the camera accessory shoe.**

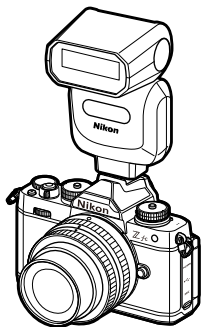

See the documentation provided with the unit for details.

- 2 Turn on the camera and flash unit.**

The flash will begin charging; the flash-ready indicator (⚡) will appear in the shooting display when charging is complete.

- 3 Choose the flash control mode (□501) and flash mode (□502).**

- 4 Adjust shutter speed and aperture.**

- 5 Take pictures.**

✔ Shutter speed

Shutter speed can be set as follows when an optional flash unit is used:

Mode	Shutter speed
	Set automatically by camera (1/200 s–1/60 s)
P, A	Set automatically by camera (1/200 s–1/60 s)*
S	1/200 s–30 s
M	1/200 s–30 s, Bulb, Time

* Shutter speed may be set as slow as 30 s if slow sync, rear-curtain sync, or slow sync with red-eye reduction is selected for flash mode.

✔ Third-party flash units

The camera cannot be used with flash units that would apply voltages over 250 V to the camera's X contacts or short-circuit contacts on the accessory shoe. Use of such flash units could not only interfere with normal operation of the camera but also damage the flash sync circuits of the camera and/or flash.

✔ i-TTL flash control

When an optional flash unit that supports the Nikon Creative Lighting System is attached and set to TTL, the camera uses monitor pre-flashes for balanced or standard "i-TTL fill-flash" flash control. i-TTL flash control is not available with flash units that do not support the Nikon Creative Lighting System. The camera supports the following types of i-TTL flash control:

Flash control	Description
i-TTL balanced fill-flash	The camera uses "i-TTL balanced fill-flash" flash control for a natural balance between the main subject and ambient background lighting. After the shutter-release button is pressed and immediately before the main flash, the flash unit emits a series of monitor pre-flashes which the camera

Flash control	Description
i-TTL balanced fill-flash	uses to optimize flash output for a balance between the main subject and ambient background lighting.
Standard i-TTL fill-flash	Flash output is adjusted to bring lighting in the frame to a standard level; the brightness of the background is not taken into account. Recommended for shots in which the main subject is emphasized at the expense of background details, or when exposure compensation is used.

- Standard i-TTL fill-flash is activated automatically when [**Spot metering**] is selected.

Flash control mode

When a flash unit (an SB-500, SB-400, or SB-300) is mounted on the camera, the flash control mode, flash level, and other flash settings can be adjusted using the **[Flash control]** > **[Flash control mode]** item in the photo shooting menu.

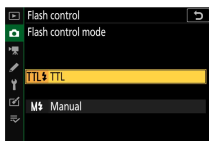









- Settings for flash units other than the SB-500, SB-400, and SB-300 can only be adjusted using flash unit controls.

Option	Description
[TTL]	<ul style="list-style-type: none">• Flash output is adjusted automatically in response to shooting conditions.• Flash compensation can be adjusted using [Flash compensation] in the photo shooting menu.
[Manual]	<ul style="list-style-type: none">• Choose the flash level manually.• Flash output is selected using [Manual output amount].

Flash modes

Use the **[Flash mode]** item in the photo shooting menu to choose the effect produced by the flash. The options available vary with the shooting mode.

	Option	Description	Available in
	[Fill flash] (front-curtain sync)	This mode is recommended in most situations. In modes P and A , shutter speed will automatically be set to values between 1/200 s (or 1/4000 s with auto FP high-speed sync) and 1/60 s.	<small>AUTO</small>  , P, S, A, M
	[Red-eye reduction]	Use for portraits. The red-eye reduction lamp on the camera or flash unit lights before the flash fires, reducing “red-eye”. <ul style="list-style-type: none"> • A flash unit with red-eye reduction is required. • The desired results may not be achieved if the subject or camera moves before the shutter is released (this setting is not recommended with moving subjects or in other situations requiring a quick shutter response). 	<small>AUTO</small>  , P, S, A, M
	[Slow sync] (Slow sync)	As for “fill flash”, except that shutter speed slows automatically to capture background lighting at night or under low light. <ul style="list-style-type: none"> • Note that photos may be prone to blurring due to camera shake at slow shutter speeds. • Use of a tripod is recommended. 	P, A

Option	Description	Available in
 [Slow sync + red-eye] (red-eye reduction with slow sync)	Use to include background lighting in portraits. Red-eye reduction is combined with slow shutter speeds to capture background lighting at night or under low light. <ul style="list-style-type: none"> • Note that photos may be prone to blurring due to camera shake at slow shutter speeds. • Use of a tripod is recommended. 	P, A
 [Rear-curtain sync]	The flash fires just before the shutter closes, creating the effect of a stream of light behind moving light sources. <ul style="list-style-type: none"> • Selecting P or A after choosing this option sets the flash mode to slow sync. • Note that photos may be prone to blurring due to camera shake at slow shutter speeds. • Use of a tripod is recommended. 	P, S, A, M
 [Flash off]	The flash does not fire.	 P, S, A, M

✔ Studio strobe lighting

Rear-curtain sync cannot be used with studio flash systems, as the correct synchronization cannot be obtained.

Flash compensation

Flash compensation is used to deliberately alter flash output, for example in order to change the brightness of the subject relative to the background. Via the **[Flash compensation]** item in the photo shooting menu, flash output can be increased to make the main subject appear brighter, reduced to prevent glare, or otherwise fine-tuned to produce the desired result.

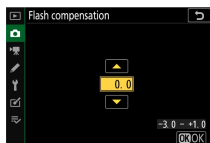

- Choose from values of from -3 to $+1$ in steps of $1/3$.
- Higher values make the subject brighter, lower values darker.
- At values other than ± 0.0 , a  icon will appear in the shooting display.
- Normal flash output can be restored by setting flash compensation to ± 0.0 . Flash compensation is not reset when the camera is turned off.

FV lock

This feature is used to lock flash output for CLS-compatible flash units, letting you take multiple photos or recompose shots without changing the flash level. Your subject need not be in the center of the frame, giving you more freedom when composing shots.

- Flash output is adjusted automatically for any changes in ISO sensitivity and aperture.
- FV lock is not available in  mode.

1 Assign [FV lock] to a control using Custom Setting f2 [Custom controls (shooting)].

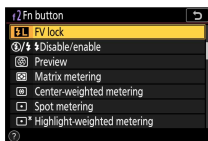

2 Mount a CLS-compatible flash unit on the camera accessory shoe.

3 Turn the flash unit on and choose a flash control mode of monitor pre-flash or A.

- If you are using an SB-500, SB-400, or SB-300 mounted on the camera accessory shoe, choose [TTL] for [Flash control] > [Flash control mode] in the photo shooting menu.
- For information on other flash units, see the documentation provided with the unit.

4 Focus.

Position the subject in the center of the frame and press the shutter-release button halfway to focus.



5 Lock flash level.

- After confirming that the flash-ready indicator (⚡) appears in the shooting display, press the **[FV lock]** control; the flash unit will emit a monitor pre-flash to determine the appropriate flash level.
- Flash output will lock and an FV lock icon (🔒) will appear in the shooting display.



6 Recompose the shot.



7 Press the shutter-release button the rest of the way down to shoot.

If desired, additional pictures can be taken without releasing FV lock. Repeat Steps 6 to 7 to take additional shots.



8 Release FV lock.

Press the [**FV lock**] control to release FV lock and confirm that the FV lock icon () is no longer displayed in the shooting display.

Remote flash photography

What is remote flash photography?

Take pictures with one or more remote flash units using wireless flash control (Advanced Wireless Lighting, or AWL). For information on using a flash unit mounted on the camera accessory shoe, see “On-Camera flash photography” (□497).

Throughout this chapter, operations involving the camera and accessories connected to the camera are indicated by , operations involving remote flash units by . For more information on using remote flash units (), see the documentation provided with the flash unit.

Controlling remote flash units

Remote flash units can be controlled via optical signals from an optional flash unit mounted on the camera accessory shoe and functioning as a master flash (optical AWL). For information on compatible flash units, see “Features available with CLS-compatible flash units” (□543).

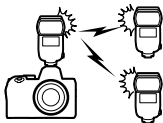

- If the flash unit in question is an SB-500, settings can be adjusted from the camera. For more information, see “Using optical AWL with the SB-500” (□509). See the documentation provided with the flash units for more information.
- Settings for other flash units must be adjusted using flash unit controls. For more information, see the documentation provided with the flash unit in question.

Using optical AWL with the SB-500

When an optional flash unit SB-500 is mounted on the accessory shoe of the camera, **[Wireless flash options]** is displayed in **[Flash control]** in the photo shooting menu. Group flash can be performed by selecting **[Optical AWL]** in **[Wireless flash options]**.

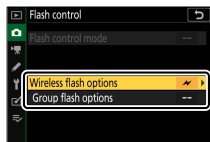

- 1 : Highlight [Group flash options] in the [Flash control] display and press .

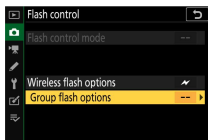

2 Adjust flash output and choose the channel and flash control mode.

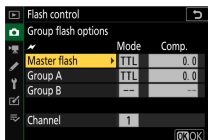

- Choose the flash control mode and flash level for the master flash and the remote flash units in each group.
- The following options are available:

Option	Description
TTL	i-TTL flash control.
 A	Auto aperture. Available only with compatible flash units.
M	Choose the flash level manually.
-- (off)	The remote units do not fire. [Comp.] cannot be adjusted.

- Select **[3]** for [**Channel**].

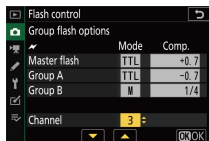

3 Set the channel of the remote flash units to [3].

4 : Group the remote flash units.

- Choose a group (A or B).
- There is no limit on the number of remote flash units that may be used. The practical maximum, however, is three per group, as the light emitted by the remote flash units will interfere with performance if more flash units are used.

5 : Compose the shot and arrange the flash units.

- See the documentation provided with the flash units for more information.
- Test-fire the units and confirm that they are functioning normally. To test-fire the units, press the test button on the master flash.

6 : Take the photograph after confirming that the flash-ready lights for all flash units are lit.

Remote flash photography

- Position the sensor windows on the remote flash units to pick up the light from the master flash. Particular care is required if the master flash is mounted on a hand-held camera.
 - Be sure that direct light or strong reflections from the remote flash units do not enter the camera lens (in [TTL] mode) or the photocells on the remote flash units ([A] mode). Otherwise light from the flash units may interfere with exposure.
 - Even if [---] is selected for [Master flash] > [Mode], the master flash may emit low-intensity timing flashes. These flashes may appear in photographs taken at short range. This can be prevented by choosing low ISO sensitivities or small apertures (high f-numbers).
 - After positioning the remote flash units, take a test shot and view the results in the camera display.
-

Troubleshooting

Before contacting customer support

You may be able to resolve any issues with the camera by following the steps below. Check this list before consulting your retailer or Nikon-authorized service representative.

STEP 1

Check the list of common problems.

Common problems and solutions are listed in the following sections:

- "Problems and solutions" (□515)
- "Alerts and error messages" (□524)

STEP 2

Turn the camera off and remove the battery, then wait about a minute, re-insert the battery and turn the camera on.

✔ The camera may continue to write data to the memory card after shooting. Wait at least a minute before removing the battery.

STEP 3

Search Nikon websites.

- For support information and answers to frequently asked questions, visit the website for your country or region (□35).
- To download the latest firmware for your camera, visit: <https://downloadcenter.nikonimglib.com/>

STEP 4 | Consult a Nikon-authorized service representative.

✓ Restoring default settings

- Depending on current settings, some menu items and other features may be unavailable. To access menu items that are grayed out or features that are otherwise unavailable, try restoring default settings using the [**Reset all settings**] item in the setup menu.
 - Note, however, that wireless network profiles, copyright information, and other user-generated entries will also be reset. Once reset, settings cannot be restored.
-

Problems and solutions

Solutions to some common issues are listed below.

Battery/display

● The camera is on but does not respond:

- Wait for recording and other operations to end.
 - If the problem persists, turn the camera off.
 - If the camera does not turn off, remove and reinsert the battery.
 - Any data currently being recorded will be lost.
 - Data that have already been recorded are not affected by removing the battery.
-

● The viewfinder or monitor does not turn on:

- Have you changed the monitor mode? Choose a different monitor mode using the **[M]** button.
 - Have you limited the choice of monitor modes available using the **[Limit monitor mode selection]** item in the setup menu? Adjust settings as required.
 - Dust, lint, or other foreign matter on the eye sensor may prevent it functioning normally. Clean the eye sensor with a blower.
-

● The viewfinder is out of focus:

- Rotate the diopter adjustment control to adjust viewfinder focus.
 - If adjusting viewfinder focus does not correct the problem, set the focus mode to **AF-S** and the AF-area mode to single-point AF. Next, select the center focus point, choose a high-contrast subject, and focus using autofocus. With the camera in focus, use the diopter adjustment control to bring the subject into clear focus in the viewfinder.
-

● The display in the viewfinder, monitor, or control panel turns off without warning:

Choose longer delays for Custom Setting c3 **[Power off delay]**.

Shooting

- **The camera takes time to turn on:**

More time will be needed to find files if the memory card contains large numbers of files or folders.

- **The shutter cannot be released:**

- Is a memory card inserted, and if so, does it have space available?
 - Is the memory card write-protected?
 - If you selected mode **S** after selecting a shutter speed of “**Bulb**” or “**Time**” in mode **M**, choose a different shutter speed.
 - Is [**Release locked**] selected for [**Slot empty release lock**] in the setup menu?
-

- **The camera is slow to respond to the shutter-release button:**

Select [**Off**] for Custom Setting d3 [**Exposure delay mode**].

- **Burst shooting is unavailable:**

Burst shooting cannot be used in conjunction with HDR.

- **Photos are out of focus:**

- Is the camera in manual focus mode? To enable autofocus, select **AF-A**, **AF-S**, **AF-C**, or **AF-F** for focus mode.
 - Autofocus does not perform well under the following conditions. In these cases, use manual focus or focus lock. Autofocus does not perform well if: there is little or no contrast between the subject and the background, the focus point contains objects at different distances from the camera, the subject is dominated by regular geometric patterns, the focus point contains areas of sharply contrasting brightness, background objects appear larger than the subject, or the subject contains many fine details.
-

- **The beep does not sound:**

- Is [**On**] selected for [**Silent photography**] in the photo shooting menu?
- If **AF-C** is selected for focus mode or if **AF-A** is selected and you are shooting in **AF-C**, a beep will not sound when the camera focuses.

- Select an option other than **[Off]** for **[Beep options]** > **[Beep on/off]** in the setup menu.
 - The beep does not sound in video mode.
-

● **The full range of shutter speeds is not available:**

Using a flash restricts the range of shutter speeds available. Flash sync speed can be set to values of 1/200–1/60 s using Custom Setting e1 **[Flash sync speed]**. When using flash units that support auto FP high-speed sync, choose **[1/200 s (Auto FP)]** for a full range of shutter speeds.

● **Focus does not lock when the shutter-release button is pressed halfway:**

If **AF-C** is selected for focus mode or if **AF-A** is selected and you are shooting in **AF-C**, press the **AF-L (On)** button to lock the focus.

● **Focus-point selection is not available:**

Not available when **[Auto-area AF]**, **[Auto-area AF (people)]**, or **[Auto-area AF (animals)]** is selected for AF-area mode.

● **The camera is slow to record photos:**

Is **[On]** selected for **[Long exposure NR]** in the photo shooting menu?

● **Photographs and videos do not appear to have the same exposure as the preview shown in the display:**

- The effects of changes to settings that affect exposure and color are not visible in the display when **[Off]** is selected for Custom Setting d7 **[Apply settings to live view]**.
 - Note that changes to **[Monitor brightness]** and **[Viewfinder brightness]** have no effect on images recorded with the camera.
-

● **Flicker or banding appears in video mode:**

Select **[Flicker reduction]** in the video recording menu and choose an option that matches the frequency of the local AC power supply.

● **Bright regions or bands appear:**

Bright regions or bands may occur if the subject is lit by a flashing sign, flash, or other light source with brief duration.

- **Smudges appear in photographs:**

- Are there smudges on the front or rear (mount-side) lens elements?
 - Is there foreign matter on the image sensor? See “Manual cleaning” (□575), or consult a Nikon-authorized service representative.
-

- ***Bokeh* is irregular:**

With fast shutter speeds and/or fast lenses, you may notice irregularities in how *Bokeh* is shaped. The effect can be mitigated by choosing slower shutter speeds and/or higher f-numbers.

- **Pictures are affected by noticeable ghosting or flare:**

You may notice ghosting or flare in shots that include the sun or other bright light sources. These effects can be mitigated by attaching a lens hood or by composing shots with bright light sources well out of the frame. You can also try such techniques as removing lens filters, choosing a different shutter speed, or using silent photography.

- **Shooting ends unexpectedly or does not start:**

- Shooting may end automatically to prevent the camera overheating, for example if:
 - The ambient temperature is high
 - The camera has been used for extended periods to record videos
 - The camera has been used in continuous release modes for extended periods
 - If photographs cannot be taken because the camera is running hot, turn the camera off and wait for it to cool before trying to take photographs again. Note that the camera may feel warm to the touch, but this does not indicate a malfunction.
-

- **Image artifacts appear in the display during shooting:**

- To reduce noise, adjust settings such as ISO sensitivity, shutter speed, or Active D-Lighting.
- At high ISO sensitivities, noise may become more noticeable in long exposures or in pictures recorded when the camera temperature is elevated.

- Randomly-spaced bright pixels, fog, or bright spots may arise as a result of increases in the temperature of the camera's internal circuits. Turn the camera off when it is not in use.
 - Randomly-spaced bright pixels, fog, lines or unexpected colors may appear if you press the **Q** button to zoom in on the view through the lens during shooting.
 - Note that the distribution of noise in the display may differ from that in the final picture.
-

● **The camera cannot measure a value for preset manual white balance:**

The subject is too dark or too bright.

● **Certain pictures cannot be selected as sources for preset manual white balance:**

Pictures created with cameras of other types cannot serve as sources for preset manual white balance.

● **White balance (WB) bracketing is unavailable:**

- White balance bracketing is not available when a RAW or RAW + JPEG option is selected for image quality.
 - White balance bracketing cannot be used in multiple exposure and HDR modes.
-

● **The effects of [Set Picture Control] differ from image to image:**

[Auto] is selected for [Set Picture Control] or as the basis for a custom Picture Control created using [Manage Picture Control], or [A] (auto) is selected for [Quick sharp], [Contrast], or [Saturation]. For consistent results over a series of photographs, choose a setting other than [A] (auto).

● **The option selected for metering cannot be changed:**

The option selected for metering cannot be changed during exposure lock.

● **Exposure compensation is not available:**

Changes to exposure compensation in mode **M** apply only to the exposure indicator and have no effect on shutter speed or aperture.

● **Uneven shading may appear in long exposures:**

Uneven shading may appear in long exposures shot at shutter speeds of “**Bulb**” or “**Time**”. The effect can be mitigated by selecting [**On**] for [**Long exposure NR**] in the photo shooting menu.

● **The AF-assist illuminator does not light:**

- Is [**Off**] selected for Custom Setting a11 [**Built-in AF-assist illuminator**]?
 - The illuminator does not light in video mode.
 - If **AF-C** is selected for focus mode, if **AF-A** is selected and you are shooting in **AF-C**, or if **MF** is selected, the illuminator does not light.
-

● **Sound is not recorded with videos:**

- Is [**Microphone off**] selected for [**Microphone sensitivity**] in the video recording menu?
 - Was the video recorded with [**Manual**] chosen for [**Microphone sensitivity**] in the video recording menu and a low sensitivity selected?
-

Playback

● **RAW pictures are not visible during playback:**

The camera displays only the JPEG copies of pictures taken with [**RAW + JPEG fine**], [**RAW + JPEG normal**], or [**RAW + JPEG basic**] selected for [**Image quality**].

● **Pictures taken with other cameras are not displayed:**

Pictures recorded with other types of camera may not display correctly.

● **Not all photos are visible during playback:**

Select [**All**] for [**Playback folder**] in the playback menu.

● **“Tall” (portrait) orientation photos are displayed in “wide” (landscape) orientation:**

- Is [**Off**] selected for [**Rotate tall**] in the playback menu?
- Auto image rotation is not available during picture review.
- Camera orientation may not be correctly recorded in photos taken with the camera pointing up or down.

● **Pictures cannot be deleted:**

- Is the memory card write-protected?
 - Are the pictures protected?
-

● **Pictures cannot be retouched:**

- The pictures cannot be further edited with this camera.
 - There is insufficient space on the memory card to record the retouched copy.
-

● **The camera displays the message, [Folder contains no pictures.]:**

Select **[All]** for **[Playback folder]** in the playback menu.

● **RAW pictures cannot be printed:**

- Print JPEG copies of the pictures created using a tool such as the **[RAW processing]** item in the retouch menu.
 - Copy the pictures to a computer and print them using NX Studio or other software that supports the RAW format.
-

● **Pictures are not displayed on HDMI devices:**

Confirm that an HDMI cable is correctly connected.

● **Output to HDMI devices does not function as expected:**

- Confirm that an HDMI cable is correctly connected.
 - Is **[On]** selected for **[HDMI] > [Advanced] > [External recording control]** in the setup menu?
 - Pictures may display correctly if default settings are restored using the **[Reset all settings]** item in the setup menu.
-

● **The effects of [Set Picture Control], [Active D-Lighting], or [Vignette control] are not visible:**

In the case of RAW images, the effects can only be viewed using Nikon software. View RAW images using NX Studio.

● **Pictures cannot be copied to a computer:**

Depending on the operating system, you may be unable to upload pictures when the camera is connected to a computer. Copy pictures from the memory card to a computer using a card reader or other device.

Bluetooth and Wi-Fi (wireless networks)

- **Smart devices do not display the camera SSID (network name):**

- Navigate to the setup menu and confirm both that [**Disable**] is selected for [**Airplane mode**] and that [**Enable**] is selected for [**Connect to smart device**] > [**Pairing (Bluetooth)**] > [**Bluetooth connection**].
 - Confirm that [**Connect to smart device**] > [**Wi-Fi connection**] is enabled in the setup menu.
 - Try disabling and re-enabling wireless network features on the smart device.
-

- **The camera cannot connect to printers and other wireless devices:**

The camera cannot establish wireless connections with devices other than smartphones, tablets, computers, and the ML-L7 Remote Control.

- **Pictures cannot be uploaded to smart devices via auto upload:**

- If [**Foreground**] is selected for [**Auto link**] > [**Link mode**] in the SnapBridge  tab, pictures will not be uploaded to the smart device automatically while the SnapBridge app is running in the background. Pictures will only be uploaded when the SnapBridge app is displayed (running in the foreground) on the smart device.
 - Check that the camera is paired with the smart device.
 - Check that the camera and smart device are configured for connection via Bluetooth.
-

- **The camera cannot download location data from the smart device:**

- The camera may be unable to download or display location data from smart devices depending on the version of the operating system and/or SnapBridge app used.
 - If [**Foreground**] is selected for [**Auto link**] > [**Link mode**] in the SnapBridge  tab, location data will not be downloaded to the camera. Instead, they will be embedded in photographs after they are uploaded to the smart device.
-

Miscellaneous

- **The date of recording is not correct:**

Is the camera clock set correctly? The clock is less accurate than most watches and household clocks; check it regularly against more accurate timepieces and reset as necessary.

- **Menu items cannot be selected:**

Some items are not available at certain combinations of settings.

- **[Wireless remote (ML-L7) options] cannot be selected, or the camera cannot be paired with the ML-L7 Remote Control using [Save wireless remote controller] in [Wireless remote (ML-L7) options]:**

- Use a fully-charged battery.
 - Confirm that **[Airplane mode]** in the setup menu is set to **[Disable]**.
 - The remote control cannot be used when the camera and computer are connected via USB and are communicating. End the USB connection.
-

- **The camera does not respond even when the ML-L7 Remote Control is used:**

- The camera and ML-L7 Remote Control (optional) are not connected. Press the power button on the remote control to connect them. If  is not displayed on the shooting screen, pair again and connect (□570).
 - Confirm that **[Wireless remote (ML-L7) options] > [Wireless remote connection]** in the setup menu is set to **[Enable]**.
 - Confirm that **[Airplane mode]** in the setup menu is set to **[Disable]**.
 - The remote control cannot be used when the camera and computer are connected via USB and are communicating. End the USB connection.
-

Alerts and error messages

This section lists the alerts and error messages that appear in the camera display.

Alerts

The following alerts appear in the camera display:

Alert	Problem	Solution
	Low battery.	Ready spare battery.
F -- ([--] is also displayed flashing in the control panel)	Lens is not correctly attached.	<ul style="list-style-type: none">• Ensure that the lens is correctly attached.• Ensure that retractable lenses are extended.• This indicator is also displayed when a non-CPU lens is attached via a mount adapter, but in this case no action need be taken.
Bulb (flashes)	" Bulb " selected in mode S .	<ul style="list-style-type: none">• Change shutter speed.• Select mode M.
Time (flashes)	" Time " selected in mode S .	<ul style="list-style-type: none">• Change shutter speed.• Select mode M.

Alert	Problem	Solution
(Exposure indicators and shutter speed or aperture display flash)	Subject too bright; limits of camera exposure metering system exceeded.	<ul style="list-style-type: none"> • Lower ISO sensitivity. • Shooting mode P: Use third-party ND (neutral density) filter (filter can also be used if alert is still displayed after following settings are adjusted in mode S or A). • Shooting mode S: Choose faster shutter speed. • Shooting mode A: Choose smaller aperture (higher f-number).
	Subject too dark; limits of camera exposure metering system exceeded.	<ul style="list-style-type: none"> • Increase ISO sensitivity. • Shooting mode P: Use optional flash unit (flash can also be used if alert is still displayed after following settings are adjusted in mode S or A). • Shooting mode S: Choose slower shutter speed. • Shooting mode A: Choose wider aperture (lower f-number).
 (flashes)	Flash has fired at full power.	Photo may be underexposed. Check distance to subject and settings such as aperture, flash range, and ISO sensitivity.
	Subjects appear dark and underexposed.	Use optional flash unit.

Alert	Problem	Solution
Full (flashes)	<ul style="list-style-type: none"> • Memory insufficient to record further photos. • Camera has run out of file numbers. 	<ul style="list-style-type: none"> • Delete pictures from memory card until there is room for additional pictures to be recorded. Copy pictures you wish to keep to computer or other device before proceeding. • Insert new memory card.
Err (flashes)	Camera malfunction.	Press shutter-release button again. If error persists or appears frequently, consult Nikon-authorized service representative.
Card (flashes)	The memory card is write-protected ("locked").	Slide the lock switch to the "write" position (□□598).

Error messages

The following error messages may appear in the camera display:

● **Shutter release disabled. Recharge battery.**

Battery exhausted.

- Replace with spare battery.
- Charge battery.

● **This battery cannot be used. It does not communicate properly with this camera. To use the camera safely, choose a battery designated for use in this camera.**

- Battery info not available.
 - Battery cannot be used. Contact Nikon-authorized service representative.
 - Battery level is extremely low; charge battery.
- Battery cannot supply data to camera.
 - Replace third-party batteries with genuine Nikon batteries.

● **No memory card.**

Memory card not inserted or inserted incorrectly.

- Check that card is inserted correctly.
-

● **Cannot access this memory card. Insert another card.**

Error accessing memory card.

- Check that camera supports memory card.
 - If error persists after card has been repeatedly ejected and reinserted, card may be damaged. Contact retailer or Nikon-authorized service representative.
-

● **Memory card is locked. Slide lock to "write" position.**

The memory card is write-protected ("locked").

- Slide the lock switch to the "write" position (□598).
-

● **This card is not formatted. Format the card.**

Memory card is not correctly formatted.

- Format memory card.
 - Replace with correctly-formatted memory card.
-

● **FTZ mount adapter firmware version not supported. Upgrade FTZ firmware.**

The firmware of the mount adapter is not the latest version.

- Update the firmware of the mount adapter to the latest version. For information on firmware updates, see the Nikon website for your area.
-

● **Recording interrupted. Please wait.**

Memory card does not support required video write speed.

- Use card that supports required write speed or change option selected for [**Frame size/frame rate**] in video recording menu.
-

● **The camera is too hot. It cannot be used until it cools. Please wait. Camera will turn itself off.**

- Camera's internal temperature is elevated.
 - Suspend shooting until camera has cooled.
- High battery temperature.
 - Remove battery and wait for it to cool.

● **Folder contains no pictures.**

- Folder contains no images.
 - Insert memory card that contains pictures.
 - No pictures in folder selected for playback.
 - Use [**Playback folder**] item in playback menu to select folder that contains pictures.
-

● **Cannot display this file.**

- File has been modified using computer application or does not conform to DCF file standard.
 - File is corrupt.
 - Do not overwrite images using computer applications.
-

● **Cannot select this file.**

Selected picture cannot be retouched.

- Retouch options are available only with pictures taken with or previously retouched on camera.
-

● **This video cannot be edited.**

Selected video cannot be edited.

- Videos created with other devices cannot be edited.
 - Videos under two seconds long cannot be edited.
-

Technical notes

Compatible lenses and accessories

The camera can be used with all Z mount lenses.

NIKKOR Z DX 16–50mm f/3.5–6.3 VR

Confirm that the lens name includes “NIKKOR Z”.

Compatible F mount lenses

F mount lenses can be mounted on Z mount cameras using an FTZ mount adapter.

- Some features may not be available depending on the lens used.

Information on the F mount lenses that can be used with Z mount cameras and on any restrictions that may apply can be found in *Compatible F Mount Lenses*, available from the Nikon Download Center:

<https://downloadcenter.nikonimglib.com/en/products/491/FTZ.html>

Camera displays

For illustrative purposes, the displays are shown with all indicators lit.

Monitor

Photo mode

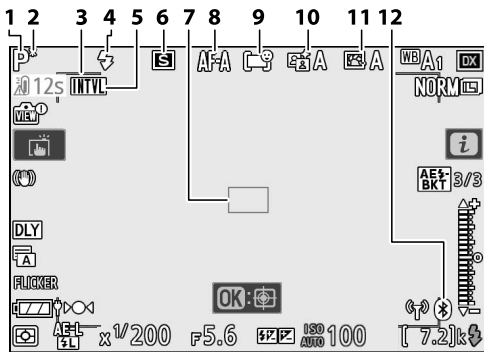

- | | | | |
|---|---|----|---|
| 1 | Shooting mode (□127) | 7 | Focus point (□85, □102) |
| 2 | Flexible program indicator (□128) | 8 | Focus mode (□100) |
| 3 | AF-area brackets (□102) | 9 | AF-area mode (□102) |
| 4 | Flash mode (□502) | 10 | Active D-Lighting (□164) |
| 5 | Interval timer indicator (□296)
⊙ icon (□84)
“No memory card” indicator (□75, □533) | 11 | Picture Control (□147) |
| 6 | Release mode (□166) | 12 | Bluetooth connection indicator (□408)
Airplane mode (□408) |

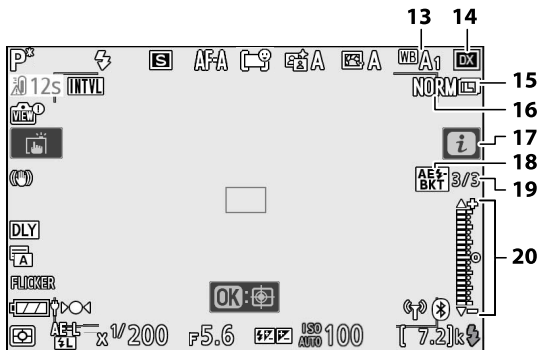

- | | | | |
|----|--|----|--|
| 13 | White balance (☐116, ☐153, ☐248) | 19 | Number of shots in exposure and flash bracketing sequence (☐271) |
| 14 | Image area (☐243) | | Number of shots in WB bracketing sequence (☐276) |
| 15 | Image size (☐161) | | Number of shots in ADL bracketing sequence (☐279) |
| 16 | Image quality (☐160) | | HDR exposure differential (☐290) |
| 17 | <i>i</i> icon (☐145) | | Number of multiple exposure (☐283) |
| 18 | Exposure and flash bracketing indicator (☐271) | 20 | Exposure indicator |
| | WB bracketing indicator (☐276) | | Exposure (☐133) |
| | ADL bracketing indicator (☐279) | | Exposure compensation (☐139) |
| | HDR indicator (☐290) | | Auto bracketing (☐270) |
| | Multiple exposure indicator (☐283) | | |

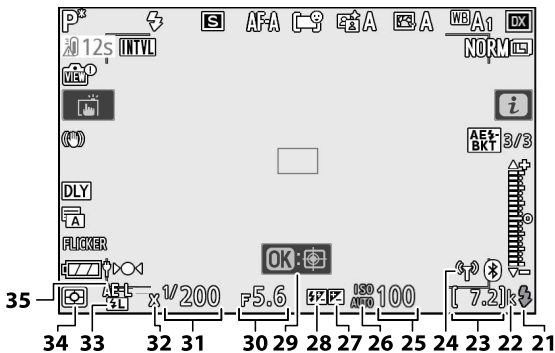

21	Flash-ready indicator (□498)	27	Exposure compensation indicator (□139)
22	"k" (appears when memory remains for over 1000 exposures; □77)	28	Flash compensation indicator (□504)
23	Number of exposures remaining (□77, □600)	29	Subject-tracking AF (□109)
24	Wi-Fi connection indicator (□164) Remote-control connection indicator (□570)	30	Aperture (□130, □131)
25	ISO sensitivity (□137)	31	Shutter speed (□128, □131)
26	ISO sensitivity indicator (□137) Auto ISO sensitivity indicator (□245)	32	Flash sync indicator (□361)
33	FV lock indicator (□505)	33	FV lock indicator (□505)
34	Metering (□162)	34	Metering (□162)
35	Autoexposure (AE) lock (□142)	35	Autoexposure (AE) lock (□142)

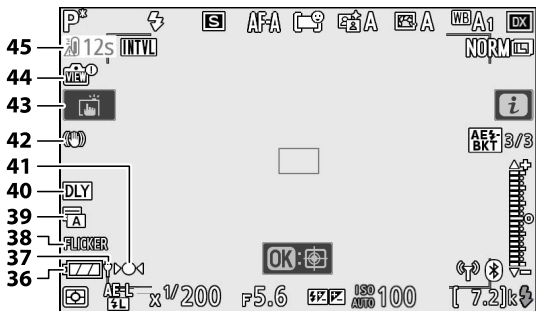

36	Battery indicator (□76)	41	Focus indicator (□112)
37	USB power delivery (□415)	42	Vibration reduction (□171)
38	Flicker detection (□265)	43	Touch shooting (□54, □110)
39	Shutter type (□357)	44	Live view preview indicator (□359)
40	Exposure delay mode (□356)	45	Temperature warning

✓ Temperature warnings

- If the camera temperature becomes elevated, a temperature warning and count-down timer will be displayed. When the timer reaches zero, the shooting display will turn off.
- The timer turns red when the thirty second mark is reached. In some cases, the timer may be displayed immediately after the camera is turned on.

✓ No memory card inserted

If no memory card is inserted, a “no memory card” indicator and [-E-] will appear in the shooting display.

● The information display

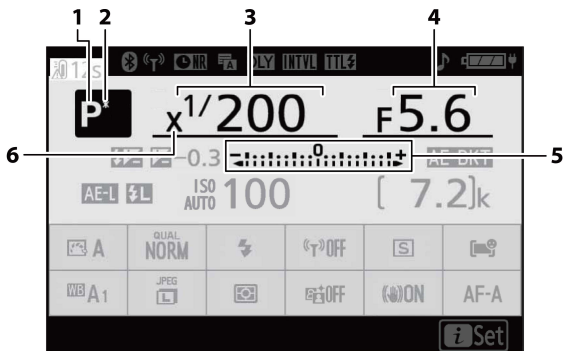

- 1 Shooting mode (□□127)
- 2 Flexible program indicator (□□128)
- 3 Shutter speed (□□128, □□131)
- 4 Aperture (□□130, □□131)

- 5 Exposure indicator
 - Exposure (□□133)
 - Exposure compensation (□□139)
 - Exposure and flash bracketing (□□271)
 - WB bracketing (□□276)
 - ADL bracketing (□□279)
- 6 Flash sync indicator (□□361)

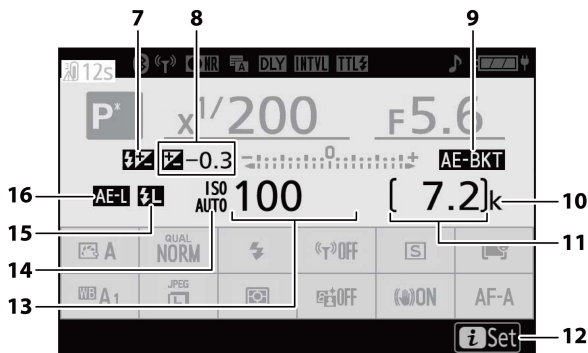

- | | | | |
|---|---|----|---|
| 7 | Flash compensation indicator (□504) | 10 | "k" (appears when memory remains for over 1000 exposures; □77) |
| 8 | Exposure compensation indicator (□139)
Exposure compensation value (□139) | 11 | Number of exposures remaining (□77, □600) |
| 9 | Exposure and flash bracketing indicator (□271)
WB bracketing indicator (□276)
ADL bracketing indicator (□279)
HDR indicator (□290)
Multiple exposure indicator (□283) | 12 | i icon (□145) |
| | | 13 | ISO sensitivity (□137) |
| | | 14 | ISO sensitivity indicator (□137)
Auto ISO sensitivity indicator (□245) |
| | | 15 | FV lock indicator (□505) |
| | | 16 | Autoexposure (AE) lock (□142) |

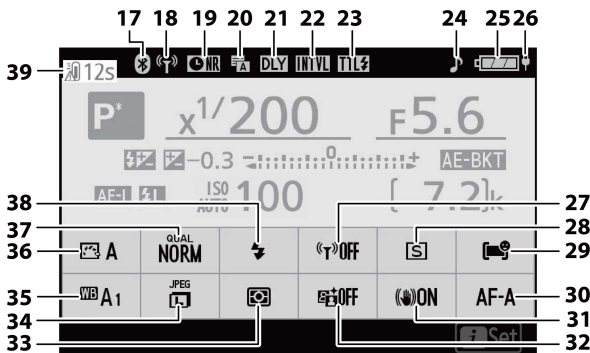

- | | |
|--|--|
| <p>17 Bluetooth connection indicator (□408)
Airplane mode (□408)</p> <p>18 Wi-Fi connection indicator (□164)
Remote-control connection indicator (□570)</p> <p>19 Long exposure noise reduction indicator (□262)</p> <p>20 Shutter type (□357)
Silent photography (□121)</p> <p>21 Exposure delay mode (□356)</p> <p>22 Interval timer indicator (□296)
⌚ icon (□84)</p> <p>23 Flash control mode (□501)</p> <p>24 “Beep” indicator (□406)</p> <p>25 Battery indicator (□76)</p> <p>26 USB power delivery (□415)</p> | <p>27 Wi-Fi connection (□164)</p> <p>28 Release mode (□166)</p> <p>29 AF-area mode (□102)</p> <p>30 Focus mode (□100)</p> <p>31 Vibration reduction (□171)</p> <p>32 Active D-Lighting (□164)</p> <p>33 Metering (□162)</p> <p>34 Image size (□161)</p> <p>35 White balance (□116, □153, □248)</p> <p>36 Set Picture Control (□147)</p> <p>37 Image quality (□160)</p> <p>38 Flash mode (□502)</p> <p>39 Temperature warning</p> |
|--|--|

Video mode

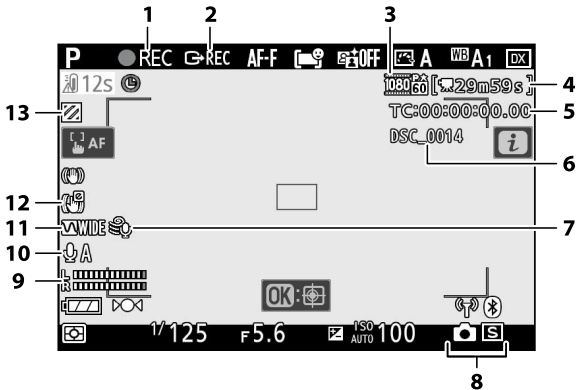

- | | | | |
|---|---|----|--|
| 1 | Recording indicator (□90)
“No video” indicator (□92) | 6 | File name (□242) |
| 2 | External recording control (□494) | 7 | Wind noise reduction (□179) |
| 3 | Frame size and rate/Video quality (□175) | 8 | Release mode (still photography; □335) |
| 4 | Time remaining (□90) | 9 | Sound level (□178) |
| 5 | Timecode (□339) | 10 | Microphone sensitivity (□178) |
| | | 11 | Frequency response (□338) |
| | | 12 | Electronic VR indicator (□181) |
| | | 13 | Highlight display (□389) |

Viewfinder

Photo mode

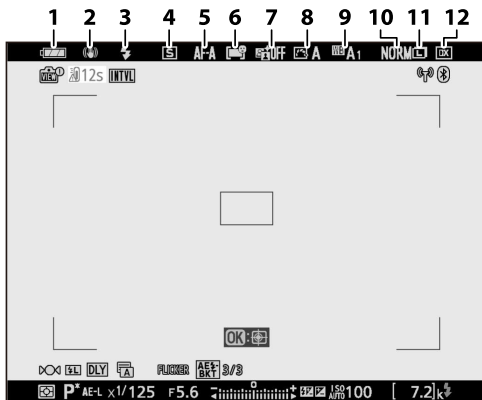

1 Battery indicator (☐76)

2 Vibration reduction (☐171)

3 Flash mode (☐502)

4 Release mode (☐166)

5 Focus mode (☐100)

6 AF-area mode (☐102)

7 Active D-Lighting (☐164)

8 Picture Control (☐147)

9 White balance (☐116, ☐153,
☐248)

10 Image quality (☐160)

11 Image size (☐161)

12 Image area (☐243)

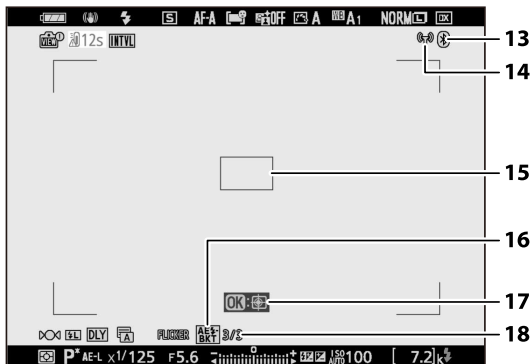

13 Bluetooth connection indicator
(☐408)

Airplane mode (☐408)

14 Wi-Fi connection indicator
(☐164)

Remote-control connection
indicator (☐570)

15 Focus point (☐85, ☐102)

16 Exposure and flash bracketing
indicator (☐271)

WB bracketing indicator

(☐276)

ADL bracketing indicator

(☐279)

HDR indicator (☐290)

Multiple exposure indicator

(☐283)

17 Subject-tracking AF (☐109)

18 Number of shots in exposure
and flash bracketing sequence

(☐271)

Number of shots in WB

bracketing sequence (☐276)

Number of shots in ADL

bracketing sequence (☐279)

HDR exposure differential

(☐290)

Number of multiple exposure

(☐283)

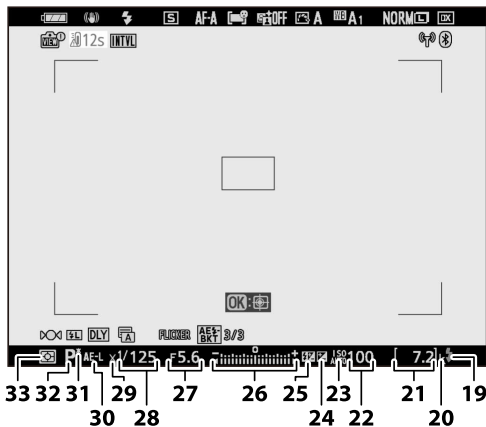

19	Flash-ready indicator (□498)	26	Exposure indicator Exposure (□133) Exposure compensation (□139) Auto bracketing (□270)
20	"k" (appears when memory remains for over 1000 exposures; □77)	27	Aperture (□130, □131)
21	Number of exposures remaining (□77, □600)	28	Shutter speed (□128, □131)
22	ISO sensitivity (□137)	29	Flash sync indicator (□361)
23	ISO sensitivity indicator (□137) Auto ISO sensitivity indicator (□245)	30	Autoexposure (AE) lock (□142)
24	Exposure compensation indicator (□139)	31	Flexible program indicator (□128)
25	Flash compensation indicator (□504)	32	Shooting mode (□127)
		33	Metering (□162)

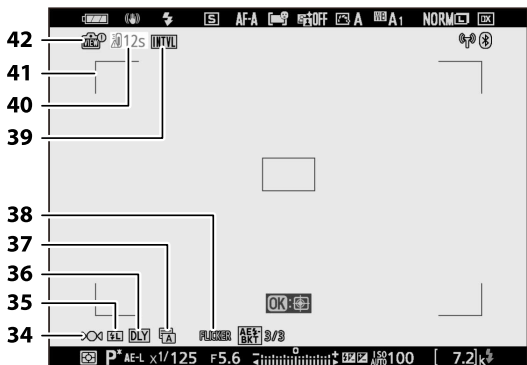

- | | | | |
|----|----------------------------|----|--|
| 34 | Focus indicator (□112) | 39 | Interval timer indicator (□296) |
| 35 | FV lock indicator (□505) | | ⊙ icon (□84) |
| 36 | Exposure delay mode (□356) | | “No memory card” indicator (□75, □533) |
| 37 | Shutter type (□357) | 40 | Temperature warning |
| | Silent photography (□121) | 41 | AF-area brackets (□102) |
| 38 | Flicker detection (□265) | 42 | Live view preview indicator (□359) |

Video mode

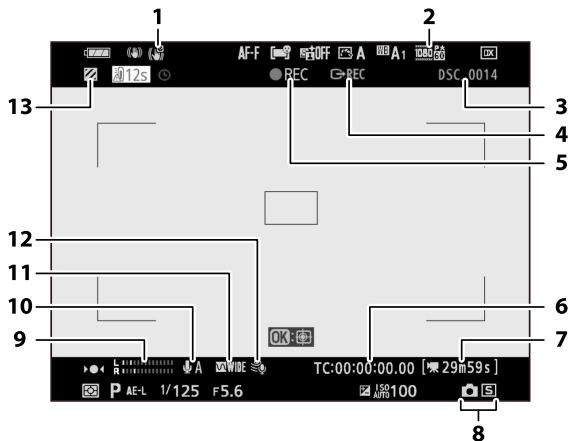

1 Electronic VR indicator (□181)

2 Frame size and rate/Video quality (□175)

3 File name (□242)

4 External recording control (□494)

5 Recording indicator (□90)
"No video" indicator (□92)

6 Timecode (□339)

7 Time remaining (□90)

8 Release mode (still photography; □335)

9 Sound level (□178)

10 Microphone sensitivity (□178)

11 Frequency response (□338)

12 Wind noise reduction (□179)

13 Highlight display (□389)

Compatible flash units

The Nikon Creative Lighting System (CLS)

Nikon's advanced Creative Lighting System (CLS) supports a variety of features thanks to improved communication between the camera and compatible flash units.

Features available with CLS-compatible flash units



Flash unit	📖	Flash unit	📖
SB-5000	543	SB-R200	552
SB-910/SB-900/SB-800	545	SB-400	554
SB-700	547	SB-300	555
SB-600	549	SU-800	557
SB-500	550		

■ ■ SB-5000

Supported features



Single flash

i-TTL	i-TTL balanced fill-flash	✓1
	Standard i-TTL fill-flash	✓2
⊗A	Auto aperture	✓
A	Non-TTL auto	-
GN	Distance-priority manual	✓

Supported features			
	M	Manual	✓
	RPT	Repeating flash	✓
Optical Advanced Wireless Lighting			
Master			
		Remote flash control	✓
	i-TTL	i-TTL	✓
	[A : B]	Quick wireless flash control	✓
	 A	Auto aperture	✓
	A	Non-TTL auto	-
	M	Manual	✓
	RPT	Repeating flash	✓
Remote			
	i-TTL	i-TTL	✓
	[A : B]	Quick wireless flash control	✓
	 A/A	Auto aperture/non-TTL auto	✓ ³
	M	Manual	✓
	RPT	Repeating flash	✓
Radio-controlled Advanced Wireless Lighting			-
Color Information Communication (flash)			✓
Color Information Communication (LED light)			-
Auto FP high-speed sync			✓ ⁴
FV lock			✓ ⁵

Supported features

Red-eye reduction	✓
Camera modeling illumination	-
Unified flash control	-
Camera flash unit firmware update	✓

- 1 Not available with spot metering.
- 2 Can also be selected via the flash unit.
- 3 Choice of  **A** and **A** depends on the option selected with the master flash.
- 4 Available only in **i-TTL**,  **A**, **A**, **GN** and **M** flash control modes.
- 5 Available only in **i-TTL** flash control mode or when the flash is configured to emit monitor pre-flashes in  **A** or **A** flash control mode.

SB-910/SB-900/SB-800

Supported features



Single flash

i-TTL	i-TTL balanced fill-flash	✓1
	Standard i-TTL fill-flash	✓2
 A	Auto aperture	✓3
A	Non-TTL auto	✓3
GN	Distance-priority manual	✓
M	Manual	✓
RPT	Repeating flash	✓

Optical Advanced Wireless Lighting

Master

Supported features

	Remote flash control		✓
	i-TTL	i-TTL	✓
	[A : B]	Quick wireless flash control	-
	 A	Auto aperture	✓
	A	Non-TTL auto	-
	M	Manual	✓
	RPT	Repeating flash	✓
Remote			
	i-TTL	i-TTL	✓
	[A : B]	Quick wireless flash control	✓
	 A/A	Auto aperture/non-TTL auto	✓ ⁴
	M	Manual	✓
	RPT	Repeating flash	✓
Radio-controlled Advanced Wireless Lighting			-
Color Information Communication (flash)			✓
Color Information Communication (LED light)			-
Auto FP high-speed sync			✓ ⁵
FV lock			✓ ⁶
Red-eye reduction			✓
Camera modeling illumination			-
Unified flash control			-
Camera flash unit firmware update			✓ ⁷

- 1 Not available with spot metering.
- 2 Can also be selected via the flash unit.
- 3 **A/A** mode selection is performed on the flash unit using custom settings.
- 4 Choice of **A** and **A** depends on the option selected with the master flash.
- 5 Available only in **i-TTL**, **A**, **A**, **GN**, and **M** flash control modes.
- 6 Available only in **i-TTL** flash control mode or when the flash is configured to emit monitor pre-flashes in **A** or **A** flash control mode.
- 7 Firmware updates for the SB-910 and SB-900 can be performed from the camera.

SB-700

Supported features



Single flash

i-TTL	i-TTL balanced fill-flash	✓1
	Standard i-TTL fill-flash	✓
A	Auto aperture	-
A	Non-TTL auto	-
GN	Distance-priority manual	✓
M	Manual	✓
RPT	Repeating flash	-

Optical Advanced Wireless Lighting

Master		
	Remote flash control	✓
i-TTL	i-TTL	✓
[A : B]	Quick wireless flash control	✓

Supported features

	 A	Auto aperture	-
	A	Non-TTL auto	-
	M	Manual	✓
	RPT	Repeating flash	-
Remote			
	i-TTL	i-TTL	✓
	[A : B]	Quick wireless flash control	✓
	 A/A	Auto aperture/non-TTL auto	-
	M	Manual	✓
	RPT	Repeating flash	✓
Radio-controlled Advanced Wireless Lighting			-
Color Information Communication (flash)			✓
Color Information Communication (LED light)			-
Auto FP high-speed sync			✓ ²
FV lock			✓ ³
Red-eye reduction			✓
Camera modeling illumination			-
Unified flash control			-
Camera flash unit firmware update			✓

- 1 Not available with spot metering.
- 2 Available only in **i-TTL**, **GN**, and **M** flash control modes.
- 3 Available only in **i-TTL** flash control mode.

Supported features

Single flash

i-TTL	i-TTL balanced fill-flash	✓1
	Standard i-TTL fill-flash	✓2
A	Auto aperture	-
A	Non-TTL auto	-
GN	Distance-priority manual	-
M	Manual	✓
RPT	Repeating flash	-

Optical Advanced Wireless Lighting

Master		
	Remote flash control	-
i-TTL	i-TTL	-
[A : B]	Quick wireless flash control	-
A	Auto aperture	-
A	Non-TTL auto	-
M	Manual	-
RPT	Repeating flash	-
Remote		
	i-TTL i-TTL	✓
	[A : B] Quick wireless flash control	✓

Supported features

	 A/A	Auto aperture/non-TTL auto	-
	M	Manual	✓
	RPT	Repeating flash	✓
Radio-controlled Advanced Wireless Lighting			-
Color Information Communication (flash)			✓
Color Information Communication (LED light)			-
Auto FP high-speed sync			✓ ³
FV lock			✓ ⁴
Red-eye reduction			✓
Camera modeling illumination			-
Unified flash control			-
Camera flash unit firmware update			-

- 1 Not available with spot metering.
- 2 Can also be selected via the flash unit.
- 3 Available only in **i-TTL** and **M** flash control modes.
- 4 Available only in **i-TTL** flash control mode.

SB-500

Supported features

Single flash

i-TTL	i-TTL balanced fill-flash	✓ ¹
	Standard i-TTL fill-flash	✓
 A	Auto aperture	-

Supported features

A	Non-TTL auto	-
GN	Distance-priority manual	-
M	Manual	✓2
RPT	Repeating flash	-

Optical Advanced Wireless Lighting

Master

	Remote flash control	✓2
i-TTL	i-TTL	✓2
[A : B]	Quick wireless flash control	-
 A	Auto aperture	-
A	Non-TTL auto	-
M	Manual	✓2
RPT	Repeating flash	-

Remote

	i-TTL	✓
[A : B]	Quick wireless flash control	✓
 A/A	Auto aperture/non-TTL auto	-
M	Manual	✓
RPT	Repeating flash	✓

Radio-controlled Advanced Wireless Lighting	-
Color Information Communication (flash)	✓
Color Information Communication (LED light)	✓

Supported features

Auto FP high-speed sync	✓ ³
FV lock	✓ ⁴
Red-eye reduction	✓
Camera modeling illumination	-
Unified flash control	-
Camera flash unit firmware update	✓

- 1 Not available with spot metering.
- 2 Can be selected using the **[Flash control]** item in the camera menus.
- 3 Available only in **i-TTL** and **M** flash control modes.
- 4 Available only in **i-TTL** flash control mode.

SB-R200

Supported features



Single flash

i-TTL	i-TTL balanced fill-flash	-
	Standard i-TTL fill-flash	-
 A	Auto aperture	-
A	Non-TTL auto	-
GN	Distance-priority manual	-
M	Manual	-
RPT	Repeating flash	-

Optical Advanced Wireless Lighting

Master

Supported features

	Remote flash control		-
	i-TTL	i-TTL	-
	[A : B]	Quick wireless flash control	-
	 A	Auto aperture	-
	A	Non-TTL auto	-
	M	Manual	-
	RPT	Repeating flash	-
Remote			
	i-TTL	i-TTL	✓
	[A : B]	Quick wireless flash control	✓
	 A/A	Auto aperture/non-TTL auto	-
	M	Manual	✓
	RPT	Repeating flash	-
Radio-controlled Advanced Wireless Lighting			-
Color Information Communication (flash)			-
Color Information Communication (LED light)			-
Auto FP high-speed sync			✓1
FV lock			✓2
Red-eye reduction			-
Camera modeling illumination			-
Unified flash control			-
Camera flash unit firmware update			-

- 1 Available only in **i-TTL** and **M** flash control modes.
- 2 Available only in **i-TTL** flash control mode.

SB-400

Supported features

Single flash

i-TTL	i-TTL balanced fill-flash	✓ ¹
	Standard i-TTL fill-flash	✓
 A	Auto aperture	-
A	Non-TTL auto	-
GN	Distance-priority manual	-
M	Manual	✓ ²
RPT	Repeating flash	-

Optical Advanced Wireless Lighting

Master		
	Remote flash control	-
i-TTL	i-TTL	-
[A : B]	Quick wireless flash control	-
 A	Auto aperture	-
A	Non-TTL auto	-
M	Manual	-
RPT	Repeating flash	-
Remote		
i-TTL	i-TTL	-

Supported features

	[A : B]	Quick wireless flash control	-
	 A/A	Auto aperture/non-TTL auto	-
	M	Manual	-
	RPT	Repeating flash	-
Radio-controlled Advanced Wireless Lighting			-
Color Information Communication (flash)			✓
Color Information Communication (LED light)			-
Auto FP high-speed sync			-
FV lock			✓ ³
Red-eye reduction			✓
Camera modeling illumination			-
Unified flash control			-
Camera flash unit firmware update			-

- 1 Not available with spot metering.
- 2 Can be selected using the **[Flash control]** item in the camera menus.
- 3 Available only in **i-TTL** flash control mode.

SB-300

Supported features



Single flash

i-TTL	i-TTL balanced fill-flash	✓ ¹
	Standard i-TTL fill-flash	✓
 A/A	Auto aperture	-

Supported features

A	Non-TTL auto	-
GN	Distance-priority manual	-
M	Manual	✓ ²
RPT	Repeating flash	-

Optical Advanced Wireless Lighting

Master		
	Remote flash control	-
i-TTL	i-TTL	-
[A : B]	Quick wireless flash control	-
 A	Auto aperture	-
A	Non-TTL auto	-
M	Manual	-
RPT	Repeating flash	-
Remote		
	i-TTL	-
i-TTL	i-TTL	-
[A : B]	Quick wireless flash control	-
 A/A	Auto aperture/non-TTL auto	-
M	Manual	-
RPT	Repeating flash	-
Radio-controlled Advanced Wireless Lighting		-
Color Information Communication (flash)		✓
Color Information Communication (LED light)		-

Supported features	
Auto FP high-speed sync	-
FV lock	✓ ³
Red-eye reduction	-
Camera modeling illumination	-
Unified flash control	-
Camera flash unit firmware update	✓

- 1 Not available with spot metering.
- 2 Can be selected using the **[Flash control]** item in the camera menus.
- 3 Available only in **i-TTL** flash control mode.



■ The SU-800 Wireless Speedlight Commander

When mounted on a CLS-compatible camera, the SU-800 can be used as a commander for SB-5000, SB-910, SB-900, SB-800, SB-700, SB-600, SB-500, or SB-R200 flash units. Group flash control is supported for up to three groups. The SU-800 itself is not equipped with a flash.

Supported features		
Single flash		
i-TTL	i-TTL balanced fill-flash	-
	Standard i-TTL fill-flash	-
 A	Auto aperture	-
A	Non-TTL auto	-
GN	Distance-priority manual	-
M	Manual	-
RPT	Repeating flash	-

Supported features

Optical Advanced Wireless Lighting

Master			
	Remote flash control		✓
	i-TTL	i-TTL	-
	[A : B]	Quick wireless flash control	✓1
	 A	Auto aperture	-
	A	Non-TTL auto	-
	M	Manual	-
	RPT	Repeating flash	-
Remote			
	i-TTL	i-TTL	-
	[A : B]	Quick wireless flash control	-
	 A/A	Auto aperture/non-TTL auto	-
	M	Manual	-
	RPT	Repeating flash	-
Radio-controlled Advanced Wireless Lighting			-
Color Information Communication (flash)			-
Color Information Communication (LED light)			-
Auto FP high-speed sync			✓2
FV lock			✓3
Red-eye reduction			-
Camera modeling illumination			-

Supported features

Unified flash control	-
Camera flash unit firmware update	-

- 1 Available during close-up photography only.
- 2 Disabled when **RPT** is selected for flash control mode.
- 3 Available only in **i-TTL** flash control mode or when the flash is configured to emit monitor pre-flashes in **Ⓐ** flash control mode.

Notes and tips for optional flash units

When using an optional flash unit, be sure also to read the documentation supplied with the unit.

- If the unit supports CLS, refer to the section on CLS-compatible digital SLR cameras. This camera is not included in the “digital SLR” category in the documentation for the SB-80DX, SB-28DX, and SB-50DX.
- If the flash-ready indicator (⚡) flashes for about three seconds after a photograph is taken in i-TTL or non-TTL auto mode, the flash has fired at full power and the photograph may be underexposed (CLS-compatible flash units only).
- i-TTL flash control can be used at ISO sensitivities between 100 and 12800.
- At ISO sensitivities over 12800, the desired results may not be achieved at some ranges or aperture settings.
- In mode **P**, the maximum aperture (minimum f-number) is limited according to ISO sensitivity, as shown below:

Maximum aperture (f-number) at ISO equivalent of:							
100	200	400	800	1600	3200	6400	12800
4	5	5.6	7.1	8	10	11	13

- * If the maximum aperture of the lens is smaller than given above, the maximum value for aperture will be the maximum aperture of the lens.
- The SB-5000, SB-910, SB-900, SB-800, SB-700, SB-600, SB-500, and SB-400 provide red-eye reduction in red-eye reduction and slow-sync with red-eye reduction flash modes.
- “Noise” in the form of lines may appear in flash photographs taken with an SD-9 or SD-8A high-performance battery pack attached directly to the camera. Reduce ISO sensitivity or increase the distance between the camera and the battery pack.
- The camera provides AF-assist illumination as required. AF-assist illuminators on optional flash units will not light.
- When an SC-series 17, 28, or 29 sync cable is used for off-camera flash photography, correct exposure may not be achieved in i-TTL mode. We recommend that you select standard i-TTL fill-flash. Take a test shot and view the results in the camera display.
- In i-TTL, do not use any form of flash panel (diffusion panel) other than the flash unit’s built-in flash panel or supplied bounce adapter. Using other panels may produce incorrect exposure.

✔ Flash photography

Flash photography cannot be combined with some camera features, including:

- silent photography,
- video recording, and
- HDR (high dynamic range)

✔ Using FV lock with optional flash units

- FV lock is available with optional flash units in TTL and (where supported) monitor pre-flash **⊗A** and monitor pre-flash **A** flash control modes (see the documentation provided with the flash unit for more information).
- Note that when Advanced Wireless Lighting is used to control remote flash units, you will need to set the flash control mode for the master or at least one remote group to **TTL**, **⊗A**, or **A**.

✔ Other flash units

The following flash units can be used in non-TTL auto (**A**) and manual modes. The options available do not vary with the lens used.

Flash unit	Supported features
SB-80DX, SB-28DX, SB-28, SB-26, SB-25, SB-24	Non-TTL auto, Manual, Repeating flash, Rear-curtain sync ¹
SB-50DX, SB-23, SB-29, SB-21B, SB-29S	Manual, Rear-curtain sync ¹
SB-30, SB-272, SB-22S, SB-22, SB-20, SB-16B, SB-15	Non-TTL auto, Manual, Rear-curtain sync ¹

- 1 Available when the camera is used to select the flash mode.
- 2 Mounting an SB-27 on the camera automatically sets the flash mode to **TTL**, but setting the flash mode to **TTL** disables the shutter release. Set the SB-27 to **A**.

✔ Metering areas for FV lock

The areas metered when FV lock is used with optional flash units are as follows:

- Stand-alone flash unit

Flash control mode	Metered area
i-TTL	6-mm circle in center of frame
Auto aperture (⊕A)	Area metered by flash exposure meter

- Remote flash units

Flash control mode	Metered area
i-TTL	Entire frame
Auto aperture (⊕A)	Area metered by flash exposure meter
Non-TTL auto (A)	

✔ Flash compensation for optional flash units

In i-TTL and auto aperture (⊕A) flash control modes, the flash compensation selected with the optional flash unit or the camera [**Flash control**] item is added to the flash compensation selected with the [**Flash compensation**] item in the photo shooting menu.

✔ Studio strobe lighting

To adjust the color and brightness of the view through the lens so that shots are easier to frame, select [**Off**] for Custom Setting d7 [**Apply settings to live view**].

Other compatible accessories

A variety of accessories are available for your Nikon camera.

✔ Compatible accessories

- Availability may vary with country or region.
- See our website or brochures for the latest information.

● Power sources

- **EN-EL25 Rechargeable Li-ion Battery:** Can be used with Nikon Z fc digital cameras.
- **MH-32 Battery Charger:** Can be used to recharge EN-EL25 batteries.
- **EH-7P Charging AC Adapter:** The EH-7P can be used to charge batteries inserted in the camera.
 - The battery will not charge while the camera is on.
 - The charging AC adapter can be used to power the camera; to do so, select **[Enable]** for **[USB power delivery]** in the setup menu. For more information, see “USB power delivery” (□415).

● Filters

- Neutral Color (NC) filters can be used to protect the lens.
- Filters may cause ghosting when the subject is framed against a bright light, or when a bright light source is in the frame. Filters can be removed if ghosting occurs.
- Matrix metering may not produce the desired results with filters with exposure factors (filter factors) over 1× (Y44, Y48, Y52, O56, R60, X0, X1, C-PL, ND2S, ND4, ND4S, ND8, ND8S, ND400, A2, A12, B2, B8, B12). We suggest that **[Center-weighted metering]** be selected instead. See the filter documentation for details.
- Filters intended for special-effects photography may interfere with autofocus or the in-focus indicator (●).

● USB cables

- **UC-E24 USB Cable:** A USB cable with a type C connector for connection to the camera and a type A connector for connection to the USB device.

- **UC-E25 USB Cable:** A USB cable with two type C connectors.

- **Hot shoe adapters**

AS-15 Sync Terminal Adapter: Mount the AS-15 on the camera hot shoe to connect studio strobe lights or other flash equipment via a sync terminal.

- **Accessory shoe covers**

BS-1 Accessory Shoe Cover: A cover protecting the accessory shoe when no flash unit is attached.

- **Body caps**

BF-N1 Body Cap: The body cap prevents dust entering the camera when no lens is in place.

- **Viewfinder eyepiece accessories**

DK-32 Rubber Eyecup: A rubber eyecup that can be fitted to the camera viewfinder. The DK-29 makes the image in the viewfinder easier to see, preventing eye fatigue.

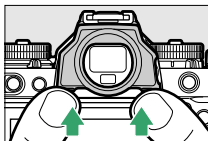

Remove

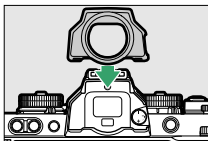

Replace

- **Mount adapters**

FTZ Mount Adapter: An adapter that allows NIKKOR F mount lenses to be used with digital cameras that support interchangeable Z mount lenses.

- For information on attaching, removing, maintaining, and using FTZ mount adapters, refer to the documentation supplied with the device.

- * If a warning message prompting you to update is displayed on the camera when a mount adapter is mounted on the camera, update to the latest version. For information on firmware updates, see the Nikon website for your area.

● Microphones

- **ME-1 Stereo Microphone:** Connect the ME-1 to the camera microphone jack to record stereo sound. Using an external microphone also reduces the chance of picking up equipment noise, such as the sounds produced during video recording when focus is achieved using autofocus.
- **ME-W1 Wireless Microphone:** A wireless Bluetooth microphone. Use the ME-W1 for off-camera recording.

● Remote controls

ML-L7 Remote Control: Pair it with the camera and shoot videos and photos remotely.

✔ Attaching and removing the accessory shoe cover

The cover slides into the shoe as shown. To remove the cover, hold the camera firmly, press the cover down with a thumb and slide it in the direction shown.

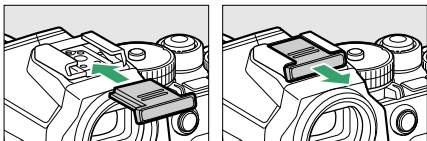

Charging the camera with the charging AC adapter

When a battery is inserted in the camera, the optional EH-7P Charging AC Adapter can be used to charge the battery.

- After confirming that the camera is off, connect the charging AC adapter (①) and plug the adapter in. The battery charges while the camera is off. Keep the plug straight during insertion and removal.

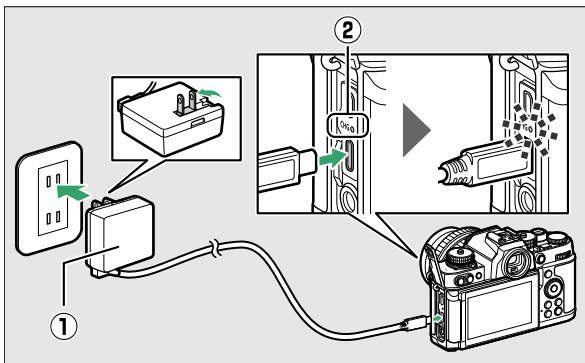

- The camera charge lamp (②) lights amber while charging is in progress. The lamp turns off when charging is complete.
- An exhausted battery will fully charge in about 1 hour and 40 minutes.
- Unplug the charging AC adapter and remove the cable from the camera when charging is complete.

✔ The charging AC adapter

If the battery cannot be charged using the charging AC adapter, for example because the battery is not compatible or the temperature of the camera is elevated, the charge lamp will flash rapidly for about 30 seconds and then turn off. If the charge lamp is off and you did not observe the battery charging, turn the camera on and check the battery level.

✔ **Powering the camera with the charging AC adapter**

- If [**Enable**] is selected for [**USB power delivery**] in the setup menu, the charging AC adapter will power the camera when the camera is turned on. For more information, see “Power delivery” versus “charging” (□417).
- The battery will not charge while the camera is powered by an outside source.

✔ **Computer USB power delivery and battery charging**

- Computers will supply current to power the camera or charge the battery only when connected via a UC-E25 USB cable (available separately). The optional UC-E24 USB cable cannot be used for this purpose.
 - Depending on the model and product specifications, some computers will not supply current to power the camera or charge the battery.
-

ML-L7 Remote Control

You can operate the camera from the remote control by pairing* (□570) the optional ML-L7 Remote Control with the camera. With this camera, you can perform the operation in “Remote control part names and functions (for Z fc)” (□568).

- * Connecting the camera and remote control via Bluetooth is called “pairing” here.
- Only one remote control can be paired per camera. When pairing another remote control, only the last paired remote control is enabled.
- Also see the documentation supplied with the ML-L7 Remote Control.

✔ **Notes when using the remote control**

The remote control cannot be used in the following cases.

- When [**Airplane mode**] in the camera setup menu is set to [**Enable**]
 - While the camera is connected to and exchanging data with a computer via USB
-

Remote control part names and functions (for Z fc)

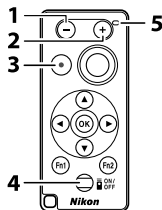

Part	Function
1 - button	Same operation as the (?) button on the camera.
2 + button	Same operation as the button on the camera.
3 Video-record button	Press to start recording, and press again to end recording.
4 Power button	When pressed, the remote control turns on and starts searching for a paired camera. If you press and hold it for 3 seconds or longer, the remote control will start searching for unpaired cameras. Pressing the power button while the remote control is on will turn it off.
5 Status lamp	The remote control status and shooting operation status are indicated by the color and behavior of the lamp (570).

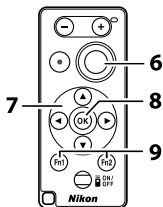

	Part	Function
6	Shutter-release button	<p>Corresponds to the shutter-release button on the camera.</p> <ul style="list-style-type: none"> There is no halfway press or press and hold function. You cannot use the continuous shooting function, which requires press and hold. Bulb shooting works the same way as Time shooting.
7	Multi selector	Same operation as the multi selector on the camera.
8	Ⓞ (select) button	Same operation as the Ⓞ button on the camera.
9	Fn1 (function 1)/Fn2 (function 2) button	<p>Use functions registered beforehand (□414).</p> <ul style="list-style-type: none"> By default, pressing the Fn1 button on the remote control is the same operation as the  button on the camera, while the Fn2 button is the same operation as the MENU button.

✔ Standby timer when using the remote control

When the standby timer of the camera expires and the monitor and viewfinder are off, turn on the remote control and then press and hold the shutter-release button or video-record button on the remote control to return to the original state.

✔ Remote control status lamp (for Z fc)

Color	Status	Description
Green	Flashing about every second	Detecting paired camera
Green	Flashing quickly (about every 0.5 seconds)	Pairing
Green	Flashing about every 3 seconds	Connected to the camera
Orange	Flashes once	Start shooting photo
Orange	Flashes twice	End shooting photo
Red	Flashes once	Start recording video
Red	Flashes twice	End recording video

■■ Connecting for the first time: Pairing

When using the remote control for the first time, you must pair it with the camera.

1 Select [Wireless remote (ML-L7) options] > [Save wireless remote controller] in the camera setup menu and press .



- The camera will standby for pairing.
- If the camera is connected to a smartphone or computer, connection to those devices will be terminated.

2 Press and hold the power button on the remote control (3 seconds or longer).

- The camera and remote control will start pairing. In the meantime, the remote control status lamp flashes at about 0.5 second intervals.
- When pairing is complete, the camera and remote control will be connected.  is displayed in the shooting display.



- If a message indicating that pairing failed is displayed, start over from Step 1.

■ ■ To connect with a paired remote control

- 1 Select [Wireless remote (ML-L7) options] > [Wireless remote connection] > [Enable] in the camera setup menu and press .

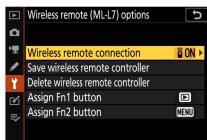

- 2 Press the power button on the remote control.

- The camera and remote control are automatically connected.

Software

The following Nikon software can be used with the camera:

● Computer software

Nikon computer software is available from the Nikon Download Center. Check the version and system requirements and be sure to download the latest version.

<https://downloadcenter.nikonimglib.com/>

- **NX Studio***: View and edit photos and videos shot with Nikon digital cameras. Use NX Studio software to fine-tune photos shot in Nikon's unique NEF/NRW (RAW) formats or convert them to JPEG or TIFF (RAW processing). NX Studio can be used not only with RAW pictures but also with JPEG and TIFF photos shot with Nikon digital cameras for such tasks as editing tone curves and enhancing brightness and contrast.

* Existing users should be sure to download the latest version, as earlier versions may be unable to download pictures from the camera.

- **Wireless Transmitter Utility**: The Wireless Transmitter Utility is required if the camera is to be connected to a network. Pair the camera with the computer and download pictures via Wi-Fi.
- **Webcam Utility**: A module that allows you to connect the camera to a computer with a USB cable and use the camera as a webcam. When you select an external camera in web conferencing software, "Webcam Utility" is displayed. Select it to use it as a webcam. Check the Webcam Utility page on the Nikon Download Center for compatible cameras, usage, operating environment, and precautions during use.

● Smartphone (tablet) apps

SnapBridge: Download photos and videos from the camera to your smart device via a wireless connection.

- SnapBridge apps can be downloaded from the Apple App Store® or on Google Play™.
- Visit the Nikon website for the latest SnapBridge apps information.

Caring for the camera

Storage

When the camera will not be used for an extended period, remove the battery. Before removing the battery, confirm that the camera is off. Do not store the camera in locations that:

- are poorly ventilated or subject to humidities of over 60%
- are next to equipment that produces strong electromagnetic fields, such as televisions or radios
- are exposed to temperatures above 50 °C (122 °F) or below –10 °C (14 °F)

Cleaning

The procedure varies with the part that requires cleaning. The procedures are detailed below.

- Do not use alcohol, thinner, or other volatile chemicals.

■ ■ Camera body

Use a blower to remove dust and lint, then wipe gently with a soft, dry cloth. After using the camera at the beach or seaside, wipe off sand or salt with a cloth lightly dampened in distilled water and dry the camera thoroughly.

Important: *The following are not covered under warranty:*

- *damage caused by the entry of dust, sand, or other foreign matter into the camera, and*
- *damage caused by using an aerosol blower too close to the camera.*

■ ■ Lens and viewfinder

These glass elements are easily damaged: remove dust and lint with a blower. If using an aerosol blower, keep the can vertical to prevent the

discharge of liquid that could damage glass elements. To remove fingerprints and other stains, apply a small amount of lens cleaner to a soft cloth and clean with care.

■ ■ Monitor

Remove dust and lint with a blower. When removing fingerprints and other stains, wipe the surface lightly with a soft cloth or chamois leather. Do not apply pressure, as this could result in damage or malfunction.

Manual cleaning

Dirt or dust entering the camera when lenses are exchanged or the body cap is removed may adhere to the surface of the image sensor and affect your photographs. The sensor can be cleaned manually as described below. Note, however, that the sensor is extremely delicate and easily damaged; we recommend that manual cleaning be performed only by a Nikon-authorized service representative.

1 Turn the camera off and remove the lens.

2 Holding the camera so that light can enter the camera, examine the image sensor for dust or lint.

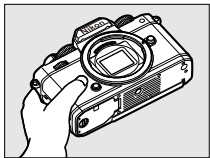

If no foreign objects are present, proceed to Step 4.

3 Remove any dust and lint from the sensor with a blower.

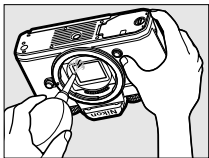

- Do not use a blower-brush. The bristles could damage the sensor.
- Dirt that cannot be removed with a blower can only be removed by Nikon-authorized service personnel. Under no circumstances should you touch or wipe the sensor.

4 Replace the lens or supplied body cap.

✔ Foreign matter on the image sensor

Foreign matter entering the camera when lenses or body caps are removed or exchanged (or in rare circumstances lubricant or fine particles from the camera itself) may adhere to the image sensor, where it may appear in photographs taken under certain conditions. To prevent entry of foreign matter when attaching the body cap or exchanging lenses, avoid dusty environments and be sure to remove all dust and other foreign matter that may be adhering to the camera mount, lens mount, or body cap. To protect the camera when no lens is in place, be sure to replace the supplied body cap. For foreign matter adhering to the image sensor, clean the image sensor as described in “Manual cleaning” (□□575), or have the sensor cleaned by authorized Nikon service personnel. Photographs affected by the presence of foreign matter on the sensor can be retouched using the clean image options available in some imaging applications.

✔ Servicing the camera and accessories

The camera is a precision device and requires regular servicing; Nikon recommends that the camera be inspected once every one to two years, and that it be serviced once every three to five years (note that fees apply to these services).

- Frequent inspection and servicing are particularly recommended if the camera is used professionally.
 - Any accessories regularly used with the camera, such as lenses or optional flash units, should be included when the camera is inspected or serviced.
-

Caring for the camera and battery:

Cautions

Camera care

- **Do not drop**

Do not drop the camera or lens or subject them to blows. The product may malfunction if subjected to strong shocks or vibration.

- **Keep dry**

Keep the camera dry. Rusting of the internal mechanism caused by water inside the camera can not only be expensive to repair but can in fact cause irreparable damage.

- **Avoid sudden changes in temperature**

If you bring the camera from a cold place to a warm place, or from a warm place to a cold place, water droplets may form inside and outside the camera and cause damage. When you bring the camera to a place with a temperature difference, place the camera in a carrying case or plastic bag and seal it beforehand. When the camera has adapted to the ambient temperature, take it out from the bag and use it.

- **Keep away from strong magnetic fields**

Static charges or the magnetic fields produced by equipment such as radio transmitters could interfere with the monitor, corrupt data stored on the memory card, or affect the product's internal circuitry.

- **Do not leave the lens pointed at the sun**

Do not leave the lens pointed at the sun or other strong light source for extended periods. Intense light may damage the image sensor or cause fading or "burn in". Photographs taken with the camera may exhibit a white blur effect.

- **Lasers and other bright light sources**

Do not direct lasers or other extremely bright light sources toward the lens, as this could damage the camera's image sensor.

- **Cleaning**

When cleaning the camera body, use a blower to gently remove dust and lint, then wipe gently with a soft, dry cloth. After using the camera at the beach or seaside, wipe off any sand or salt using a cloth lightly dampened in fresh water and then dry the camera thoroughly.

- **Cleaning the lens and viewfinder**

These glass elements are easily damaged: remove dust and lint with a blower. If using an aerosol blower, keep the can vertical to prevent the discharge of liquid that could damage glass elements. To remove fingerprints and other stains from the lens, apply a small amount of lens cleaner to a soft cloth and wipe the lens carefully.

- **Do not touch the image sensor**

Under no circumstances should you exert pressure on the image sensor, poke it with cleaning tools, or subject it to powerful air currents from a blower. These actions could scratch or otherwise damage the sensor.

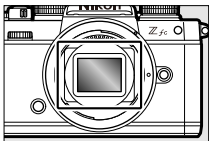

- **Cleaning the image sensor**

For information on cleaning the image sensor, see "Manual cleaning" (□□575).

- **The lens contacts**

Keep the lens contacts clean. Avoid touching them with your fingers.

- **Store in a well-ventilated area**

To prevent mold or mildew, store the camera in a dry, well-ventilated area. Do not store the camera with naphtha or camphor moth balls, next to equipment that produces strong electromagnetic, or where it will be exposed to extremely high temperatures, for example near a heater or in an enclosed vehicle on a hot day. Failure to observe these precautions could result in product malfunction.

- **Long-term storage**

To prevent damage caused by, for example, leaking battery fluid, remove the battery if the product will not be used for an extended period. Store the camera in a plastic bag containing a desiccant. Do not, however, store the leather camera case in a plastic bag, as this may cause the material to deteriorate. Store the battery in a cool, dry place. Note that desiccant gradually loses its capacity to absorb moisture and should be replaced at regular intervals. To prevent mold or mildew, take the camera out of storage at least once a month, insert the battery, and release the shutter a few times.

- **Turn the product off before removing the battery.**

Removing the battery while the camera is on could damage the product. Particular care should be taken not to remove or disconnect the power source while images are being recorded or deleted.

- **Monitor/viewfinder**

- The monitors (including viewfinder) are constructed with extremely high precision; at least 99.99% of pixels are effective, with no more than 0.01% being missing or defective. Hence while these displays may contain pixels that are always lit (white, red, blue, or green) or always off (black), this is not a malfunction. Images recorded with the device are unaffected. Your understanding is requested.
- Images in the monitor may be difficult to see in a bright light.
- Do not apply pressure to the monitor. The monitor could malfunction or suffer damage. Dust or lint on the monitor can be removed with a blower. Stains can be removed by wiping the monitor lightly with a soft cloth or chamois leather. Should the monitor break, care should be taken to avoid

injury from broken glass. Be careful that liquid crystal from the monitor does not touch the skin or enter the eyes or mouth.

- Should you experience any of the following symptoms while framing shots in the viewfinder, discontinue use until your condition improves:
 - nausea, eye pain, eye fatigue,
 - dizziness, headache, stiffness in your neck or shoulders,
 - queasiness or loss of hand-eye coordination, or
 - motion sickness.
- The display may rapidly flicker on and off during burst photography. Watching the flickering display could cause you to feel unwell. Discontinue use until your condition improves.

● **Bright lights and back-lit subjects**

Noise in the form of lines may in rare cases appear in pictures that include bright lights or back-lit subjects.

Battery care

● **Precautions for use**

- If improperly handled, batteries may rupture or leak, causing the product to corrode. Observe the following precautions when handling batteries:
 - Turn the product off before replacing the battery.
 - Batteries may be hot after extended use.
 - Keep the battery terminals clean.
 - Use only batteries approved for use in this equipment.
 - Do not short or disassemble batteries or expose them to flame or excessive heat.
 - When the battery is not inserted in the camera or charger, keep it in a plastic bag or other non-conductive container so that the terminals are insulated.
- If the battery is hot, for example immediately after use, wait for it to cool before charging. Attempting to charge the battery while its internal temperature is elevated will impair battery performance, and the battery may not charge or charge only partially.

- If the battery will not be used for some time, insert it in the camera and run it flat before removing it from the camera for storage. The battery should be stored in a cool, dry location with an ambient temperature of 15 °C to 25 °C (59 °F to 77 °F). Avoid hot or extremely cold locations.
- Batteries should be charged within six months of use. During long periods of disuse, charge the battery and use the camera to run it flat once every six months before returning it to a cool location for storage.
- Remove the battery from the camera or charger when not in use. The camera and charger draw minute amounts of charge even when off and could draw the battery down to the point that it will no longer function.
- Do not use the battery at ambient temperatures below 0 °C (32 °F) or above 40 °C (104 °F). Failure to observe this precaution could damage the battery or impair its performance. Charge the battery indoors at ambient temperatures of 5 °C–35 °C (41 °F–95 °F). The battery will not charge if its temperature is below 0 °C (32 °F) or above 60 °C (140 °F).
- Capacity may be reduced and charging times increase at battery temperatures from 0 °C (32 °F) to 15 °C (59 °F) and from 45 °C (113 °F) to 60 °C (140 °F).
- Batteries in general exhibit a drop in charging capacity at low ambient temperatures.
- Batteries in general exhibit a drop in available capacity at low ambient temperatures. The change in capacity with temperature is reflected in the camera battery-level display. As a result, the battery display may show a drop in capacity as the temperature drops, even if the battery is fully charged.
- Batteries may be hot after use. Observe due caution when removing batteries from the camera.

● **Charge batteries before use**

Charge the battery before use. The supplied battery is not fully charged at shipment.

- **Ready spare batteries**

Before taking photographs, ready a spare battery and keep it fully charged. Depending on your location, it may be difficult to purchase replacement batteries on short notice.

- **Have fully-charged spare batteries ready on cold days**

Partially-charged batteries may not function on cold days. In cold weather, charge one battery before use and keep another in a warm place, ready to be exchanged as necessary. Once warmed, a cold battery may recover some of its charge.

- **Battery level**

- Turning the camera on or off repeatedly when the battery is fully discharged will shorten battery life. Batteries that have been fully discharged must be charged before use.
- A marked drop in the time a fully charged battery retains its charge when used at room temperature indicates that it requires replacement. Purchase a new rechargeable battery.

- **Do not attempt to charge fully-charged batteries**

Continuing to charge the battery after it is fully charged can impair battery performance.

- **Recycling used batteries**

Recycle rechargeable batteries in accord with local regulations, being sure to first insulate the terminals with tape.

Using the charger

- Do not move the charger or touch the battery during charging; failure to observe this precaution could in very rare instances result in the charger showing that charging is complete when the battery is only partially charged. Remove and reinsert the battery to begin charging again.
- Do not short the charger terminals. Failure to observe this precaution could result in overheating and damage to the charger.
- Unplug the charger when it is not in use.

- Use the MH-32 Battery Charger with compatible batteries only.
- Do not use chargers with damage that leaves the interior exposed or that produce unusual sounds when used.
- The symbols on this product represent the following:
 - ~ AC, --- DC,  Class II equipment (the construction of the product is double-insulated)

Using the charging AC adapter

- Do not move the camera or touch the battery during charging. Failure to observe this precaution could in very rare instances result in the camera showing that charging is complete when the battery is only partially charged. Disconnect and reconnect the adapter to begin charging again.
- Do not short the adapter terminals. Failure to observe this precaution could result in overheating and damage to the charger.
- Unplug the adapter when it is not in use.
- Do not use adapters with damage that leaves the interior exposed or that produce unusual sounds when used.
- The symbols on this product represent the following:
 - ~ AC, --- DC,  Class II equipment (the construction of the product is double-insulated)

Specifications

Nikon Z fc digital camera

Type	
Type	Digital camera with support for interchangeable lenses
Lens mount	Nikon Z mount

Lens	
Compatible lenses	<ul style="list-style-type: none">• Z mount NIKKOR lenses• F mount NIKKOR lenses (mount adapter required; restrictions may apply)

Effective pixels	
Effective pixels	20.9 million

Image sensor	
Type	23.5 × 15.7 mm CMOS sensor (Nikon DX format)
Total pixels	21.51 million
Dust-reduction system	Image Dust Off reference data (NX Studio software required)

Storage	
Image size (pixels)	<ul style="list-style-type: none"> • [DX (24×16)] selected for image area: <ul style="list-style-type: none"> - 5568 × 3712 (Large: 20.7 M) - 4176 × 2784 (Medium: 11.6 M) - 2784 × 1856 (Small: 5.2 M) • [1:1 (16×16)] selected for image area: <ul style="list-style-type: none"> - 3712 × 3712 (Large: 13.8 M) - 2784 × 2784 (Medium: 7.8 M) - 1856 × 1856 (Small: 3.4 M) • [16:9 (24×14)] selected for image area: <ul style="list-style-type: none"> - 5568 × 3128 (Large: 17.4 M) - 4176 × 2344 (Medium: 9.8 M) - 2784 × 1560 (Small: 4.3 M) • Photographs taken while recording videos at a frame size of 3840 × 2160: 3840 × 2160 • Photographs taken while recording videos at other frame sizes: 1920 × 1080
File format (image quality)	<ul style="list-style-type: none"> • NEF (RAW): 12 or 14 bit • JPEG: JPEG-Baseline compliant with fine (approx. 1:4), normal (approx. 1:8), or basic (approx. 1:16) compression • NEF (RAW)+JPEG: Single photograph recorded in both NEF (RAW) and JPEG formats
Picture Control System	Auto, Standard, Neutral, Vivid, Monochrome, Portrait, Landscape, Flat, Creative Picture Controls (Dream, Morning, Pop, Sunday, Somber, Dramatic, Silence, Bleached, Melancholic, Pure, Denim, Toy, Sepia, Blue, Red, Pink, Charcoal, Graphite, Binary, Carbon); selected Picture Control can be modified; storage for custom Picture Controls
Media	SD (Secure Digital) and UHS-I compliant SDHC and SDXC memory cards

Storage	
File system	DCF 2.0, Exif 2.31

Viewfinder	
Viewfinder	1.0-cm/0.39-in. approx. 2360k-dot (XGA) OLED electronic viewfinder with color balance and auto and 7-level manual brightness controls
Frame coverage	Approx. 100% horizontal and 100% vertical
Magnification	Approx. 1.02× (50 mm lens at infinity, -1.0 m^{-1})
Eyepoint	19.5 mm (-1.0 m^{-1} ; from back end of viewfinder eyepiece lens)
Diopter adjustment	$-3 - +3 \text{ m}^{-1}$
Eye sensor	Automatically switches between monitor and viewfinder displays

Monitor	
Monitor	7.5-cm/3.0-in., approx. 1040k-dot vari-angle TFT touch-sensitive LCD with 170° viewing angle, approximately 100% frame coverage, and color balance and 11-level manual brightness controls

Shutter	
Type	Electronically-controlled vertical-travel focal-plane mechanical shutter; electronic front-curtain shutter; electronic shutter

Shutter	
Speed	<ul style="list-style-type: none"> • Using the shutter-speed dial: 1/4000 – 4 s (1 step), Bulb, Time, X (Flash sync) • Using the main command dial: 1/4000 – 30 s (1/3 step, can be extended up to 900 s in mode M), Bulb, Time, X (Flash sync)
Flash sync speed	X=1/200 s; synchronizes with shutter at 1/200 s or slower; auto FP high-speed sync supported

Release	
Release mode	Single frame, Continuous L, Continuous H, Continuous H (extended), Self-timer
Approximate frame advance rate	<ul style="list-style-type: none"> • Continuous L: Approx. 1 – 4 fps • Continuous H: Approx. 5 fps • Continuous H (extended): Approx. 11 fps <p>* Maximum frame advance rate as measured by in-house tests.</p>
Self-timer	2 s, 5 s, 10 s, 20 s; 1–9 exposures at intervals of 0.5, 1, 2, or 3 s

Exposure	
Metering system	TTL metering using camera image sensor
Metering mode	<ul style="list-style-type: none"> • Matrix metering • Center-weighted metering: Weight of 75% given to 8 mm circle in center of frame; weighting can instead be based on average of entire frame • Spot metering: Meters 3.5 mm circle (about 2.5% of frame) centered on selected focus point • Highlight-weighted metering

Exposure	
Range	-4 – +17 EV * Figures are for ISO 100 and f/2.0 lens at 20 °C/68 °F
Mode	AUTO : Auto, P : programmed auto with flexible program, S : shutter-priority auto, A : aperture-priority auto, M : manual
Exposure compensation	Range: -3 – +3 EV (-5 – +5 EV when the exposure compensation dial is set to [C]), Increment: 1/3 step
Exposure lock	Luminosity locked at detected value
ISO sensitivity (Recommended Exposure Index)	ISO 100–51200 (step sizes of 1/3 EV); can also be set to approx. 1 EV above ISO 51200 (ISO 102400 equivalent) or to approx. 2 EV above ISO 51200 (ISO 204800 equivalent); auto ISO sensitivity control available
Active D-Lighting	Auto, Extra high, High, Normal, Low, and Off
Multiple exposure	Add, average, lighten, darken
Other options	HDR (high dynamic range), photo mode flicker reduction

Autofocus	
Type	Hybrid phase-detection/contrast AF with AF assist
Detection range	-4.5 – +19 EV * Without low-light AF: -3 – +19 EV * Measured in photo mode at ISO 100 and a temperature of 20 °C/68 °F using single-servo AF (AF-S) and a lens with a maximum aperture of f/1.8

Autofocus	
Lens servo	<ul style="list-style-type: none"> • Autofocus: Single-servo AF (AF-S), continuous-servo AF (AF-C), AF mode auto-switch (AF-A, photo mode only), full-time AF (AF-F, video mode only), predictive focus tracking • Manual focus (M): Electronic rangefinder can be used
Focus points	209 focus points * Number of focus points available in photo mode with single-point AF selected for AF-area mode and DX selected for image area
AF-area mode	Pinpoint AF (photo mode only), single-point AF, dynamic-area AF (photo mode only), wide-area AF (S), wide-area AF (L), wide-area AF (L-people), wide-area AF (L-animals), auto-area AF, auto-area AF (people), auto-area AF (animals)
Focus lock	Press the $\overset{AE-L}{AF-L}$ (On) button or press shutter-release button halfway (single-servo AF/ AF-S)

Flash	
Flash control	TTL: i-TTL flash control; i-TTL balanced fill-flash is used with matrix, center-weighted, and highlight-weighted metering, standard i-TTL fill-flash with spot metering
Flash mode	Front-curtain sync, slow sync, rear-curtain sync, red-eye reduction, red-eye reduction with slow sync, off
Flash compensation	-3 – +1 EV (step size of 1/3 EV) available in modes P , S , A , and M
Flash-ready indicator	Lights when optional flash unit is fully charged; flashes as underexposure warning after flash is fired at full output
Accessory shoe	ISO 518 hot-shoe with sync and data contacts and safety lock

Flash	
Nikon Creative Lighting System (CLS)	i-TTL flash control, optical Advanced Wireless Lighting, FV lock, Color Information Communication, auto FP high-speed sync
White balance	
White balance	Auto (3 types), natural light auto, direct sunlight, cloudy, shade, incandescent, fluorescent (3 types), flash, choose color temperature (2500 K–10,000 K), preset manual (up to 6 values can be stored), all with fine-tuning except choose color temperature
Bracketing	
Bracketing	Exposure and/or flash, white balance, and ADL
Video	
Metering system	TTL metering using camera image sensor
Metering mode	Matrix, center-weighted, or highlight-weighted
Frame size (pixels) and frame rate	<ul style="list-style-type: none"> • 3840 × 2160 (4K UHD): 30p (progressive)/25p/24p • 1920 × 1080: 120p/100p/60p/50p/30p/25p/24p • 1920 × 1080 slow-motion: 30p (×4)/25p (×4)/24p (×5) <p>* Actual frame rates for 120p, 100p, 60p, 50p, 30p, 25p, and 24p are 119.88, 100, 59.94, 50, 29.97, 25, and 23.976 fps respectively</p> <p>* Quality selection (normal/★) available at all sizes except 3840 × 2160, 1920 × 1080 120p/100p, and 1920 × 1080 slow-motion, when quality is fixed at ★</p>
File format	MOV, MP4

Video	
Video compression	H.264/MPEG-4 Advanced Video Coding
Audio recording format	Linear PCM (for videos recorded in MOV format) or AAC (for videos recorded in MP4 format)
Audio recording device	Built-in stereo or external microphone with attenuator option; sensitivity adjustable
Exposure compensation	Range: -3 – +3 EV, Increment: 1/3 step
ISO sensitivity (Recommended Exposure Index)	<ul style="list-style-type: none"> • M: Manual selection (ISO 100–25600; step size of 1/3 EV); auto ISO sensitivity control (ISO 100–25600) available with selectable upper limit • P, S, A: Auto ISO sensitivity control (ISO 100–25600) with selectable upper limit •  AUTO: Auto ISO sensitivity control (ISO 100–25600)
Active D-Lighting	Same as photo settings, Extra high, High, Normal, Low, and Off
Other options	Time-lapse video recording, electronic vibration reduction, time codes
Playback	
Playback	Full-frame and thumbnail (4, 9, or 72 images or calendar) playback with playback zoom, playback zoom cropping, video playback, photo and/or video slide shows, histogram display, highlights, photo information, location data display, auto image rotation, and picture rating

Interface	
USB	Type C USB connector (SuperSpeed USB); connection to built-in USB port is recommended
HDMI output	Type D HDMI connector
Audio input	Stereo mini-pin jack (3.5 mm diameter; plug-in power supported)

Wi-Fi/Bluetooth	
Wi-Fi	<ul style="list-style-type: none"> • Standards: <ul style="list-style-type: none"> - IEEE 802.11b/g/n (Africa, Asia, Bolivia, Europe, and Oceania) - IEEE 802.11b/g/n/a/ac (U.S.A., Canada, Mexico) - IEEE 802.11b/g/n/a (other countries in the Americas) • Operating frequency: <ul style="list-style-type: none"> - 2412–2462 MHz (channel 11; Africa, Asia, Bolivia, Europe, and Oceania) - 2412–2462 MHz (channel 11), 5180–5825 MHz (5180–5580 MHz, 5660–5700 MHz, and 5745–5825 MHz) (U.S.A., Canada, Mexico) - 2412–2462 MHz (channel 11), 5180–5805 MHz (5180–5320 MHz and 5745–5805 MHz) (other countries in the Americas) • Maximum output power (EIRP): <ul style="list-style-type: none"> - 2.4 GHz band: 8.1 dBm - 5 GHz band: 7.9 dBm (countries in the Americas) • Authentication: Open system, WPA2-PSK

Wi-Fi/Bluetooth

Bluetooth

- **Communication protocols:** Bluetooth Specification Version 4.2
- **Operating frequency:**
 - Bluetooth: 2402–2480 MHz
 - Bluetooth Low Energy: 2402–2480 MHz
- **Maximum output power (EIRP):**
 - Bluetooth: 2.6 dBm
 - Bluetooth Low Energy: 1.1 dBm

Power source

Battery

One EN-EL25 rechargeable Li-ion battery

Charging AC adapter

EH-7P charging AC adapter (available separately)

Tripod socket

Tripod socket

0.635 cm (1/4 in., ISO 1222)

Dimensions/weight

Dimensions

Approx. 134.5 × 93.5 × 43.5 mm/5.3 × 3.7 × 1.8 in. (width × height × depth)

Weight

Approx. 445 g (15.7 oz.) with battery and memory card but without body cap; approx. 390 g/13.8 oz. (camera body only)

Operating environment

Temperature

0 °C–40 °C (+32 °F–104 °F)

Humidity

85% or less (no condensation)

- Unless otherwise stated, all measurements are performed in conformity with Camera and Imaging Products Association (CIPA) standards or guidelines.
- All figures are for a camera with a fully-charged battery.
- The sample images displayed on the camera and the images and illustrations in this document are for expository purposes only.
- Nikon reserves the right to change the appearance and specifications of the hardware and software described in this document at any time and without prior notice. Nikon will not be held liable for damages that may result from any mistakes that this document may contain.

■ ■ MH-32 Battery Charger

Rated input	AC 100 to 240 V, 50/60 Hz, 0.21 A
Rated output	DC 8.4 V, 1.12 A (MAX)
Supported batteries	EN-EL25 Rechargeable Li-ion Battery
Charging time	Approx. 2 hours 30 minutes * Time required to charge battery at an ambient temperature of 25 °C (77 °F) when no charge remains
Operating temperature	0 °C–40 °C (+32 °F–104 °F)
Dimensions	Approx. 67 × 94 × 28 mm/2.7 × 3.8 × 1.2 in., excluding plug adapter
Weight	Approx. 99 g (3.5 oz), excluding plug adapter

The symbols on this product represent the following:

~ AC, ≡ DC, □ Class II equipment (the construction of the product is double-insulated)

■■ EN-EL25 Rechargeable Li-ion Battery

Type	Rechargeable lithium-ion battery
Rated capacity	7.6 V/1120 mAh
Operating temperature	0 °C–40 °C (+32 °F–104 °F)
Dimensions	Approx. 34 × 50.5 × 18 mm/1.4 × 2.0 × 0.8 in.
Weight	Approx. 53 g (1.9 oz)

✔ **Disposing of data storage devices**

Please note that deleting images or formatting memory cards or other data storage devices does not completely erase the original image data. Deleted files can sometimes be recovered from discarded storage devices using commercially available software, potentially resulting in the malicious use of personal image data. Ensuring the privacy of such data is the user's responsibility.

Before discarding a data storage device or transferring ownership to another person, erase all data using commercial deletion software, or format the device and then completely refill it with images containing no private information (for example, pictures of empty sky). Care should be taken to avoid injury when physically destroying data storage devices. Before discarding the camera or transferring ownership to another person, you should also use the [**Reset all settings**] item in the camera setup menu to delete network settings and other personal information.

✔ **Supported standards**

- **DCF Version 2.0:** The Design Rule for Camera File System (DCF) is a standard widely used in the digital camera industry to ensure compatibility among different makes of camera.
 - **Exif version 2.31:** The camera supports Exif (Exchangeable Image File Format for Digital Still Cameras) version 2.31, a standard introduced with the goal of improving the interoperability of printers and digital cameras, making it easier to produce high-quality prints. Information stored with photographs is used for optimal color reproduction when the images are output on Exif-compliant printers. See the printer manual for details.
 - **HDMI:** High-Definition Multimedia Interface is a standard for multimedia interfaces used in consumer electronics and AV devices. This standard ensures that audiovisual data and control signals can be transmitted to HDMI-compliant devices via a single cable connection.
-

Approved memory cards

- The camera can be used with SD, SDHC, and SDXC memory cards.
- UHS-I is supported.



- Cards rated UHS Speed Class 3 or better are recommended for video recording and playback. Slower speeds may result in recording or playback being interrupted.
- When choosing cards for use in card readers, be sure they are compatible with the device.
- Contact the manufacturer for information on features, operation, and limitations on use.

✔ The write protect switch

- SD memory cards are equipped with a write-protect switch. Sliding the switch to the “lock” position write-protects the card, protecting the data it contains.

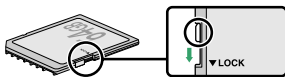

- A “----” indicator and a [**Card**] warning appear in the shooting display when a write-protected card is inserted.
 - If you attempt to release the shutter while a write-protected card is inserted, a warning will be displayed and no picture will be recorded. Unlock the memory card before attempting to take or delete pictures.
-

Portable chargers (power banks)

Portable chargers can be used to power the camera or charge the camera battery. The following table lists the portable chargers that have been tested and approved for use, together with the approximate number of shots that can be taken with, and the approximate number of times the camera battery can be charged using, each device.

Manufacturer	Model number	Number of shots ¹	Number of charges ²
Anker	PowerCore III Elite 25600 87W	2790	8

- 1 Camera and Imaging Products Association (CIPA) standard. [**Viewfinder only**] selected for monitor mode. Measured at 23 °C/73.4 °F (±2 °C/3.6 °F) with a NIKKOR Z DX 16–50mm f/3.5–6.3 VR lens under the following test conditions: one photograph taken at default settings once every 30 s. The “number of shots” is the number of shots that can be taken using a fully-charged portable charger to supply power to a camera with a fully-charged battery (EN-EL25).
- 2 The number of times the camera battery (EN-EL25) can be fully charged using a portable charger at full charge.
 - See the documentation provided with the portable charger for information on use.
 - Use a USB cable with two Type-C connectors supplied with the portable charger when employing the device to power the camera or charge the camera battery.
 - Up-to-date information on portable chargers is available on the website of the manufacturers. Availability may vary with country or region.

Memory card capacity

The following table shows buffer capacity and the approximate number of pictures that can be stored on a 32 GB¹ card at different image qualities and sizes when **[DX (24×16)]** is selected for **[Choose image area]**. Actual capacity varies with shooting conditions and the type of card.

Image quality	Image size	File size	Number of exposures remaining ²	Buffer capacity ^{2, 3}
RAW (12-bit)	Large	Approx. 19.4 MB	873 frames	44 frames
RAW (14-bit)	Large	Approx. 24.4 MB	764 frames	36 frames
JPEG fine	Large	Approx. 9.5 MB	2100 frames	83 frames
	Medium	Approx. 6.6 MB	3400 frames	100 frames
	Small	Approx. 3.7 MB	6400 frames	100 frames
JPEG normal	Large	Approx. 5.7 MB	4100 frames	100 frames
	Medium	Approx. 3.5 MB	6800 frames	100 frames
	Small	Approx. 2.0 MB	12300 frames	100 frames
JPEG basic	Large	Approx. 2.4 MB	8000 frames	100 frames
	Medium	Approx. 1.7 MB	12800 frames	100 frames
	Small	Approx. 1.1 MB	22100 frames	100 frames

- 1 Figures are for a SanDisk SD memory card (SDSDXVE-032G-JNJIP, measured in April 2021).
- 2 Number of pictures that can be saved to memory card or stored in memory buffer varies with scene recorded.

- 3 Maximum number of exposures that can be stored in memory buffer at ISO 100. If [**Auto distortion control**] is set to [**On**], the number of exposures may drop.

Battery endurance

The video footage or number of shots that can be recorded with a fully-charged EN-EL25 rechargeable Li-ion battery is given below. Actual endurance varies with such factors as the condition of the battery, the interval between shots, and the options selected in the camera menus.

Photo mode: Number of shots¹

- **[Viewfinder only]** selected for monitor mode: Approx. 310 shots
- **[Monitor only]** selected for monitor mode: Approx. 360 shots

Video mode: Length of footage²

- **[Viewfinder only]** selected for monitor mode: Approx. 80 minutes
- **[Monitor only]** selected for monitor mode: Approx. 80 minutes

Actions such as the following can reduce battery endurance:

- Keeping the shutter-release button pressed halfway
- Repeated autofocus operations
- Taking RAW photographs
- Slow shutter speeds
- Using camera Wi-Fi (wireless LAN) and Bluetooth features
- Using the camera with optional accessories connected
- Repeatedly zooming in and out
- Taking pictures at low ambient temperatures

To ensure that you get the most from rechargeable Nikon EN-EL25 batteries:

- Keep the battery contacts clean. Soiled contacts can reduce battery performance.
- Use batteries immediately after charging. Batteries will lose their charge if left unused.

1 Camera and Imaging Products Association (CIPA) standard. Measured at 23 °C/73.4 °F (±2 °C/3.6 °F) with a NIKKOR Z DX 16–50mm f/3.5–6.3 VR lens and a SanDisk SDSDXVE-032G-JNJIP memory card under the following test conditions: one photograph taken at default settings once every 30 s.

- 2 Actual battery endurance as measured under conditions specified by CIPA. Measured at 23 °C/73.4 °F (± 2 °C/3.6 °F) with a NIKKOR Z DX 16–50mm f/3.5–6.3 VR lens and a SanDisk SDSDXVE-032G-JNJIP memory card. Measurement performed at default settings.
- Each shot can be up to 29 minutes 59 seconds in length.
 - If camera temperature rises, recording may end before maximum length or size is reached.

AF-assist illumination

The AF-assist illuminator has a range of about 1–3 m (3 ft 4 in.–9 ft 10 in.). Some lenses or lens hoods may block the illuminator at certain focus distances. Remove the lens hood before shooting.

- For information on restrictions when shooting with the camera's illuminator, see the Nikon Download Center.

<https://downloadcenter.nikonimglib.com/>

Trademarks and licenses

- The SD, SDHC, and SDXC logos are trademarks of SD-3C, LLC.
- Windows is either a registered trademark or a trademark of Microsoft Corporation in the United States and/or other countries.
- Apple®, App Store®, the Apple logos, iPhone®, iPad®, Mac, and macOS are trademarks of Apple Inc. registered in the U.S. and/or other countries.
- Android, Google Play and the Google Play logo are trademarks of Google LLC. The Android robot is reproduced or modified from work created and shared by Google and used according to terms described in the Creative Commons 3.0 Attribution License.
- IOS is a trademark or registered trademark of Cisco Systems, Inc., in the United States and/or other countries and is used under license.
- HDMI, the HDMI logo and High-Definition Multimedia Interface are trademarks or registered trademarks of HDMI Licensing, LLC.

HDMI

- The Bluetooth® word mark and logo are registered trademarks owned by Bluetooth SIG, Inc., and any use of such marks by Nikon is under license.
- Wi-Fi and the Wi-Fi logo are trademarks or registered trademarks of the Wi-Fi Alliance.
- All other trade names mentioned in this document or the other documentation provided with your Nikon product are trademarks or registered trademarks of their respective holders.
- Use of the Made for Apple badge means that an accessory has been designed to connect specifically to the Apple products identified in the badge, and has been certified by the developer to meet Apple performance standards. Apple is not responsible for the operation of this device or its compliance with safety and regulatory standards. Please note that the use of this accessory with an Apple product may affect wireless performance.

✔ **FreeType License (FreeType2)**

Portions of this software are copyright © 2012 The FreeType Project (<https://www.freetype.org>). All rights reserved.

✔ **MIT License (HarfBuzz)**

Portions of this software are copyright © 2018 The HarfBuzz Project (<https://www.freedesktop.org/wiki/Software/HarfBuzz>). All rights reserved.

✔ **Unicode® Character Database License (Unicode® Character Database)**

The software for this product uses the Unicode® Character Database License open-source software. The terms of the software license are as follows:

COPYRIGHT AND PERMISSION NOTICE

Copyright © 1991-2019 Unicode, Inc. All rights reserved.

Distributed under the Terms of Use in

<https://www.unicode.org/copyright.html>.

Permission is hereby granted, free of charge, to any person obtaining a copy of the Unicode data files and any associated documentation (the “Data Files”) or Unicode software and any associated documentation (the “Software”) to deal in the Data Files or Software without restriction, including without limitation the rights to use, copy, modify, merge, publish, distribute, and/or sell copies of the Data Files or Software, and to permit persons to whom the Data Files or Software are furnished to do so, provided that either (i) this copyright and permission notice appear with all copies of the Data Files or Software, or (ii) this copyright and permission notice appear in associated Documentation.

THE DATA FILES AND SOFTWARE ARE PROVIDED “AS IS”, WITHOUT WARRANTY OF ANY KIND, EXPRESS OR IMPLIED, INCLUDING BUT NOT LIMITED TO THE WARRANTIES OF MERCHANTABILITY, FITNESS FOR A PARTICULAR PURPOSE AND NONINFRINGEMENT OF THIRD PARTY RIGHTS. IN NO EVENT SHALL THE COPYRIGHT HOLDER OR HOLDERS INCLUDED IN THIS NOTICE BE LIABLE FOR ANY CLAIM, OR ANY SPECIAL INDIRECT OR CONSEQUENTIAL DAMAGES, OR ANY DAMAGES WHATSOEVER RESULTING

FROM LOSS OF USE, DATA OR PROFITS, WHETHER IN AN ACTION OF CONTRACT, NEGLIGENCE OR OTHER TORTIOUS ACTION, ARISING OUT OF OR IN CONNECTION WITH THE USE OR PERFORMANCE OF THE DATA FILES OR SOFTWARE.

Except as contained in this notice, the name of a copyright holder shall not be used in advertising or otherwise to promote the sale, use or other dealings in these Data Files or Software without prior written authorization of the copyright holder.

✔ AVC Patent Portfolio License

THIS PRODUCT IS LICENSED UNDER THE AVC PATENT PORTFOLIO LICENSE FOR THE PERSONAL AND NON-COMMERCIAL USE OF A CONSUMER TO

(i) ENCODE VIDEO IN COMPLIANCE WITH THE AVC STANDARD (“AVC VIDEO”) AND/OR

(ii) DECODE AVC VIDEO THAT WAS ENCODED BY A CONSUMER ENGAGED IN A PERSONAL AND NON-COMMERCIAL ACTIVITY AND/OR WAS OBTAINED FROM A VIDEO PROVIDER LICENSED TO PROVIDE AVC VIDEO.

NO LICENSE IS GRANTED OR SHALL BE IMPLIED FOR ANY OTHER USE.

ADDITIONAL INFORMATION MAY BE OBTAINED FROM MPEG LA, L.L.C.

SEE <https://www.mpegla.com>

Notices

• Notices for customers in the U.S.A.

The battery charger

**IMPORTANT SAFETY INSTRUCTIONS—SAVE THESE INSTRUCTIONS
DANGER—TO REDUCE THE RISK OF FIRE OR ELECTRIC SHOCK,
CAREFULLY FOLLOW THESE INSTRUCTIONS**

For connection to a supply not in the U.S.A., use an attachment plug adapter of the proper configuration for the power outlet if needed. This power unit is intended to be correctly oriented in a vertical or floor mount position.

Federal Communications Commission (FCC) Radio Frequency Interference Statement



This equipment has been tested and found to comply with the limits for a Class B digital device, pursuant to Part 15 of the FCC rules. These limits are designed to provide reasonable protection against harmful interference in a residential installation. This equipment generates, uses, and can radiate radio frequency energy and, if not installed and used in accordance with the instructions, may cause harmful interference to radio communications. However, there is no guarantee that interference will not occur in a particular installation. If this equipment does cause harmful interference to radio or television reception, which can be determined by turning the equipment off and on, the user is encouraged to try to correct the interference by one or more of the following measures:

- Reorient or relocate the receiving antenna.
- Increase the separation between the equipment and receiver.

- Connect the equipment into an outlet on a circuit different from that to which the receiver is connected.
- Consult the dealer or an experienced radio/television technician for help.

CAUTIONS

Modifications

The FCC requires the user to be notified that any changes or modifications made to this device that are not expressly approved by Nikon Corporation may void the user's authority to operate the equipment.

Interface cables

Use the interface cables sold or provided by Nikon for your equipment. Using other interface cables may exceed the limits of Class B Part 15 of the FCC rules.

Nikon Inc., 1300 Walt Whitman Road, Melville, New York 11747-3064, U.S.A.

Tel.: 631-547-4200

● **Power cable**

At voltages over AC 125 V (U.S.A. only): The power cable must be rated for the voltage in use, be at least AWG no. 18 gauge, and have SVG insulation or better with a NEMA 6P-15 plug rated for AC 250 V 15 A.

● **Notice for customers in Canada**

CAN ICES-3 B / NMB-3 B

● **Notices for customers in Europe**

CAUTION: RISK OF EXPLOSION IF BATTERY IS REPLACED BY AN INCORRECT TYPE. DISPOSE OF USED BATTERIES ACCORDING TO THE INSTRUCTIONS.

This symbol indicates that electrical and electronic equipment is to be collected separately.



The following apply only to users in European countries:

- This product is designated for separate collection at an appropriate collection point. Do not dispose of as household waste.
- Separate collection and recycling helps conserve natural resources and prevent negative consequences for human health and the environment that might result from incorrect disposal.
- For more information, contact the retailer or the local authorities in charge of waste management.

This symbol on the battery indicates that the battery is to be collected separately.



The following apply only to users in European countries:

- All batteries, whether marked with this symbol or not, are designated for separate collection at an appropriate collection point. Do not dispose of as household waste.
- For more information, contact the retailer or the local authorities in charge of waste management.

Bluetooth and Wi-Fi (wireless LAN)

This product is controlled by the United States Export Administration Regulations (EAR). The permission of the United States government is not required for export to countries other than the following, which as of this writing are subject to embargo or special controls: Cuba, Iran, North Korea, Sudan, and Syria (list subject to change).

The use of wireless devices may be prohibited in some countries or regions. Contact a Nikon-authorized service representative before using the wireless features of this product outside the country of purchase.

The Bluetooth transmitter in this device operates in the 2.4 GHz band.

● **Notice for customers in the U.S.A. and Canada**

This device complies with part 15 of FCC Rules and Innovation, Science and Economic Development Canada's licence-exempt RSSs. Operation is subject to the following two conditions: (1) this device may not cause harmful interference, and (2) this device must accept any interference received, including interference that may cause undesired operation.

FCC WARNING

The FCC requires the user to be notified that any changes or modifications made to this device that are not expressly approved by Nikon Corporation may void the user's authority to operate the equipment.

Compliance with FCC requirement 15.407(c)

Data transmission is always initiated by software, which is then passed down through the MAC, through the digital and analog baseband, and finally to the RF chip. Several special packets are initiated by the MAC. These are the only ways the digital baseband portion will turn on the RF transmitter, which it then turns off at the end of the packet. Therefore, the transmitter will be on only while one of the aforementioned packets is being transmitted. In other words, this device automatically

discontinue transmission in case of either absence of information to transmit or operational failure.

Frequency Tolerance: ± 20 ppm

There are models that support only 2.4GHz or models that support 2.4GHz / 5GHz. The Guam sales model is only compatible with 2.4GHz.

FCC Radio Frequency Interference Statement

Note: This equipment has been tested and found to comply with the limits for a Class B digital device, pursuant to part 15 of the FCC Rules. These limits are designed to provide reasonable protection against harmful interference in a residential installation. This equipment generates, uses and can radiate radio frequency energy and, if not installed and used in accordance with the instructions, may cause harmful interference to radio communications. However, there is no guarantee that interference will not occur in a particular installation. If this equipment does cause harmful interference to radio or television reception, which can be determined by turning the equipment off and on, the user is encouraged to try to correct the interference by one or more of the following measures:

- Reorient or relocate the receiving antenna.
- Increase the separation between the equipment and receiver.
- Connect the equipment into an outlet on a circuit different from that to which the receiver is connected.
- Consult the dealer or an experienced radio/TV technician for help.

Co-location

This transmitter must not be co-located or operated in conjunction with any other antenna or transmitter.

Nikon Inc., 1300 Walt Whitman Road, Melville, New York 11747-3064, U.S.A.

Tel.: 631-547-4200

FCC/ISED RF Exposure Statement

The available scientific evidence does not show that any health problems are associated with using low power wireless devices. There is

no proof, however, that these low power wireless devices are absolutely safe. Low power Wireless devices emit low levels of radio frequency energy (RF) in the microwave range while being used. Whereas high levels of RF can produce health effects (by heating tissue), exposure of low-level RF that does not produce heating effects causes no known adverse health effects. Many studies of low-level RF exposures have not found any biological effects. Some studies have suggested that some biological effects might occur, but such findings have not been confirmed by additional research. This product has been tested and found to comply with FCC/ISED radiation exposure limits set forth for an uncontrolled environment and meets the FCC radio frequency (RF) Exposure Guidelines and RSS-102 of the ISED radio frequency (RF) Exposure rules. Please refer to the SAR test report that was uploaded to FCC website.

Compliance with RSS-247 Issue 2 §6.4

Data transmission is always initiated by software, which is the passed down through the MAC, through the digital and analog baseband, and finally to the RF chip. Several special packets are initiated by the MAC. These are the only ways the digital baseband portion will turn on the RF transmitter, which it then turns off at the end of the packet. Therefore, the transmitter will be on only while one of the aforementioned packets is being transmitted. In other words, this device automatically discontinues transmission in case of either absence of information to transmit or operational failure.

- **Notice for customers in Canada**

For indoor use only (5150-5350MHz).

- **Notice for customers in Europe and in countries complying with the Radio Equipment Directive**

Hereby, Nikon Corporation declares that the radio equipment type Z fc is in compliance with Directive 2014/53/EU.



The full texts of the EU declarations of conformity are available at the following internet addresses:

https://imaging.nikon.com/support/pdf/DoC_N2016.pdf

Wi-Fi

- **Operating frequency:**

- 2412–2462 MHz (channel 11; Africa, Asia, Bolivia, Europe, and Oceania)
- 2412–2462 MHz (channel 11), 5180–5825 MHz (5180–5580 MHz, 5660–5700 MHz, and 5745–5825 MHz) (U.S.A., Canada, Mexico)
- 2412–2462 MHz (channel 11), 5180–5805 MHz (5180–5320 MHz and 5745–5805 MHz) (other countries in the Americas)

- **Maximum output power (EIRP):**

- 2.4 GHz band: 8.1 dBm
- 5 GHz band: 7.9 dBm (countries in the Americas)

Bluetooth

- **Operating frequency:**

- Bluetooth: 2402–2480 MHz
- Bluetooth Low Energy: 2402–2480 MHz

- **Maximum output power (EIRP):**

- Bluetooth: 2.6 dBm
- Bluetooth Low Energy: 1.1 dBm

- **Notice for customers in Singapore**

Trade Name: Nikon
Model: Z fc

This device complies with radio-frequency regulations. The content of certification labels not affixed to the device is given below.

Complies with
IMDA Standards
DA103423

● Notice for customers in Nigeria

Connection and use of this communications
equipment is permitted by the Nigerian
Communications Commission

● Notice for customers in Thailand

เครื่องโทรคมนาคมและอุปกรณ์นี้ มีความสอดคล้อง ตามมาตรฐานหรือข้อั กำหนดทางเทคนิคของ กสทช.

● Security

Although one of the benefits of this product is that it allows others to freely connect for the wireless exchange of data anywhere within its range, the following may occur if security is not enabled:

- Data theft: Malicious third-parties may intercept wireless transmissions to steal user IDs, passwords, and other personal information.
- Unauthorized access: Unauthorized users may gain access to the network and alter data or perform other malicious actions. Note that due to the design of wireless networks, specialized attacks may allow unauthorized access even when security is enabled.
- Unsecured networks: Connecting to open networks may result in unauthorized access. Use secure networks only.

✔ **Conformity marking**

Some of the information related to standards with which the camera complies can be viewed using the [**Conformity marking**] option in the setup menu.

✔ **Certificates**

• **Maroc/**

المغرب

AGREE PAR L'ANRT MAROC

Numéro d'agrément : MR00027908ANRT2021



• **México**

La operación de este equipo está sujeta a las siguientes dos condiciones:

























- (1) es posible que este equipo o dispositivo no cause interferencia perjudicial y
- (2) este equipo o dispositivo debe aceptar cualquier interferencia, incluyendo la que pueda causar su operación no deseada.









• عُمان

Oman-TRA
D090024
R/11325/21

Index

Symbols

 (Auto)	85, 90
P (Programmed auto)	128
S (Shutter-priority auto)	128
A (Aperture-priority auto)	130
M (Manual)	131
 (Single frame)	166, 335
 L (Continuous L)	166
 H (Continuous H)	166
 H' (Continuous H (extended))	166
 (Self-timer)	166
 (Continuous)	336
 (Silent photography)	121
 (Electronic front-curtain shutter)	357
 (Mechanical shutter)	357
 (Pinpoint AF)	103
 (Single-point AF)	103
 (Dynamic-area AF)	103
 (Wide-area AF (S))	104
 (Wide-area AF (L))	104
 (Wide-area AF (L-people))	104
 (Wide-area AF (L-animals))	104
 (Auto-area AF)	105
 (Auto-area AF (people))	105
 (Auto-area AF (animals))	105
 (Matrix metering)	163
 (Center-weighted metering)	163
 (Spot metering)	163
 (Highlight-weighted metering)	163
 (Monitor mode) button	45

MENU button	64
 button	68, 145
 button	96
 button	99
 (Om) button	63, 142
 button	63
 button	63
 Help	68
i menu	68, 145
 mode exposure comp.	354

A

Access-point mode	457, 459
Active D-Lighting	164
ADL bracketing	279
AE & flash bracketing	271
AE bracketing	271
AE lock	142
AF activation	348
AF fine-tuning options	397
AF speed	388
AF tracking sensitivity	389
AF-A (AF mode auto-switch)	100
AF-area mode	102
AF-C (Continuous AF)	101
AF-C priority selection	344
AF-F (Full-time AF)	101
AF-S (Single AF)	101
AF-S priority selection	344
Airplane mode	408

All pictures	212	Camera-mounted flash units	497
Animal-detection AF	108	Center-weighted area	353
Aperture	130, 132	Center-weighted metering	163
Aperture-priority auto	130	Charger	74
Apply settings to live view	359	Charging AC adapter	565
Attaching a lens	78	Choose color temperature (White balance)	118
Attenuator	338	Choose image area	243
Auto (Set Picture Control)	148	Choose start/end point	204
Auto (White balance)	117	CL mode shooting speed	356
Auto bracketing	270	Clarity (Set Picture Control)	151
Auto bracketing (mode M)	364	Cloudy (White balance)	118
Auto  ISO sensitivity control	363	Color space	262
Auto distortion control	265, 334	Color temperature	120, 155, 251
Auto ISO sensitivity control	245	Command dial	48
Auto upload	475	Compensation	504
Auto-area AF	105	Conformity marking	415
Auto-area AF (animals)	105	Connect to computer	411
Auto-area AF (people)	105	Connect to smart device	408, 479, 481

B

Battery	74, 75
Battery charger	74
Beep options	406
Bluetooth	480
Bracketing order	365
Brightness (Set Picture Control)	152
Built-in AF-assist illuminator	351
Built-in microphone	91
Bulb	134

C

Calendar playback	184
-------------------------	-----

Continuous	336
Continuous AF	101
Continuous H	166
Continuous H (extended)	166
Continuous L	166
Contrast (Set Picture Control)	152
Control panel	40
Control ring	113
Copyright information	405
Creative Picture Control	149
Custom controls	382
Custom controls (playback)	375
Custom controls (shooting)	367
Custom Settings menu	341

Customize command dials	377
Customize i menu	69, 365, 381

D

D-Lighting	436
Delete	98, 211, 232
Detaching lenses	79
Diffraction compensation	264, 334
Diopter adjustment control	44
Direct connection to computer	460
Direct sunlight (White balance)	118
DISP button	61
Distortion control	438
Dynamic-area AF	103

E

Easy Connect	466
Easy exposure compensation	352
Effect level (Set Picture Control)	151
Electronic VR	181, 337
Encryption key	460, 468
Energy saving (photo mode)	417
Error (wireless connection)	488
Exposure comp. for flash	363
Exposure compensation	139
Exposure compensation dial	50, 139
Exposure delay mode	356
Exposure indicators	133
Extended shutter speeds (M)	357
Eye-detection AF	106

F

Face-detection AF	106
File information	187
File naming	242, 330
File number sequence	358
Fill flash	162, 502
Filter effects (Set Picture Control)	152
Fine-tune optimal exposure	353
Firmware version	423
Flange-back distance	114
Flash (White balance)	118
Flash bracketing	271
Flash compensation	269, 504
Flash control	267
Flash control mode	501
Flash mode	162, 502
Flash off	162, 503
Flash shutter speed	362
Flash sync speed	361
Flat (Set Picture Control)	148
Flexible program	128
Flicker reduction	334
Flicker reduction shooting	265
Fluorescent (White balance)	118
Fn button	71, 116
Focal plane mark	114
Focus indicator	113
Focus lock	142
Focus mode	100, 173, 182
Focus peaking	115, 360
Focus point options	350
Focus point wrap-around	349

Focus points used	105, 345
Focus ring	113
Focus shift shooting	319
Focus tracking with lock-on	345
Format memory card	392
Frame size/frame rate	175, 330
Framing grid display	360
Frequency response	338
Full-frame playback	183
Full-time AF	101
FV lock	505

H

HDMI	408, 494
HDR (high dynamic range)	289
Hi (ISO)	138
High ISO NR	263, 334
High sensitivity (Hi)	138
Highlight display	188, 389
Highlight-weighted metering	163
Histogram	61, 62
Hue (Set Picture Control)	152

I

Image comment	404
Image Dust Off ref photo	401
Image quality	160, 244
Image size	161, 244
Incandescent (White balance)	118
Information display	397
Infrastructure mode	458, 465
Interval timer shooting	296

IP address	469
ISO sensitivity	137
ISO sensitivity dial	49, 137
ISO sensitivity dial lock release	49, 137
ISO sensitivity settings	245, 331

L

Landscape (Set Picture Control)	148
Language	393
Limit AF-area mode selection	349
Limit monitor mode selection	397
Location data	196
Long exposure NR	262
Long time-exposures	134
Low-light AF	350

M

MAC address	413
Main command dial	48
Manage Picture Control	257, 333
Manual (Shooting mode)	131
Manual focus	101, 112
Manual focus ring in AF mode	352
Matrix metering	163
Maximum shots per burst	356
Memory buffer	169
Memory card	598
Memory card capacity	600
Metering	162
MF (Manual focus)	101
Microphone sensitivity	178, 337

Mid-range sharpening (Set Picture Control)	151	Playback display options	233
Mode selector	47, 127	Playback folder	233
Monitor	50	Playback menu	232
Monitor brightness	394	Portrait (Set Picture Control)	148
Monitor color balance	394	Power off delay	77, 355
Monochrome	440	Preset manual (White balance)	119, 156, 252
Monochrome (Set Picture Control)	148	Press the shutter-release button all the way down	88
Multiple exposure	281	Press the shutter-release button halfway	87
My Menu	449	Programmed auto	128
N		Protect	125
Natural light auto (White balance)	117	Push-button WPS	466
Network settings	411, 459, 465	Q	
Neutral (Set Picture Control)	148	Quick crop	199
Non-CPU lens data	400	Quick sharp (Set Picture Control)	151
O		R	
Overlay pictures	441	Rating	123, 236
Overview	197	RAW processing	428
P		RAW recording	245
Pairing (Bluetooth)	408	Rear-curtain sync	162, 503
Perspective control	439	Recent settings	455
Photo information	186	Rechargeable Li-ion battery	74
Photo shooting menu	237	Red-eye correction	437
Photo/video selector	85, 90	Red-eye reduction	162, 502
Picture review	234	Release button to use dial	380
Pictures shot on selected dates	213	Release mode	166, 269
PIN-entry WPS	466	Release mode (save frame)	335
Pinpoint AF	103	Remote flash photography	508
Pixel mapping	403		

Remote photography	480	Shutter-release button AE-L	354
Reset all settings	423	Shutter-speed dial	47, 128, 131
Reset custom settings	343	Shutter-speed dial lock release	
Reset photo shooting menu	238	47, 128, 131
Reset video recording menu	330	Silent photography	121, 327
Resize	432	Single AF	101
Retouch menu	424	Single frame	166, 335
Reverse indicators	381	Single-point AF	103
RGB histogram	189	Slide show	234
Rotate tall	234	Slot empty release lock	418

S

Saturation (Set Picture Control)	152	SnapBridge	479
Save current frame	207	Spot metering	163
Save focus position	401	SSID	460, 467
Save/load menu settings	419	Standard (Set Picture Control)	148
Search for Wi-Fi network	466	Standby timer	77
Select for upload	202	Storage folder	238
Select for upload (Bluetooth)	409	Store points by orientation	346
Select for upload to computer	474	Straighten	438
Selected pictures	212	Sub-command dial	48
Self-portrait mode	52, 408	Subject-tracking AF	109
Self-timer	166, 169, 355		
Set Picture Control	147, 255		
Set the clock	81		
Setup menu	391		
Shade (White balance)	118		
Sharpening (Set Picture Control)	151		
Shooting data	192		
Shutter speed	128, 131		
Shutter type	357		
Shutter-priority auto	128		

T

Thumbnail	184
Time	135
Time zone and date	393
Time-lapse video	310
Timecode	339
Toning (Set Picture Control)	152
Touch controls	54, 407
Touch shutter	110

Trim	431
Trim video	448

Wireless Transmitter Utility	457
------------------------------------	-----

U

Upload while off	410
USB power delivery	415

V

Vibration reduction	171
Video file type	331
Video quality	175, 330
Video recording menu	329
Video-record button	91
View all in continuous mode	361
Viewfinder	44
Viewfinder brightness	396
Viewfinder color balance	396
Vignette control	264, 334
Virtual horizon	61, 62
Vivid (Set Picture Control)	148

W

WB bracketing	276
White balance	116, 153, 248
Wi-Fi connection	164, 180, 409, 411
Wi-Fi mode	483
Wide-area AF (L)	104
Wide-area AF (L-animals)	104
Wide-area AF (L-people)	104
Wide-area AF (S)	104
Wind noise reduction	339
Wireless remote (ML-L7) options	413

Z

Zoom	209
------------	-----

No reproduction in any form of this manual, in whole or in part (except for brief quotation in critical articles or reviews), may be made without written authorization from NIKON CORPORATION.

NIKON CORPORATION

© 2021 Nikon Corporation

CT1G01(11)
6MO00211-01