

# **Nikon**

DIGITAL CAMERA

**Z 7**

**Z 6**

User's Manual

This manual is for camera firmware versions 3.00 and later. The latest version of the camera firmware is available for download from the Nikon Download Center.

- Read this manual thoroughly before using the camera.
- To ensure proper use of the camera, be sure to read "For Your Safety" (page ix).
- After reading this manual, keep it in a readily accessible place for future reference.

## Choose from 3 different manuals.

### **The *User's Manual* (this manual)**

Master basic camera operations as well as features specific to this camera.

- Table of Contents.....iv
- Getting to Know the Camera..... 1
- First Steps .....27
- Basic Photography and Playback.....41
- Basic Settings .....52
- Shooting Controls.....72
- The **i** Menu.....95
- Menu List .....125
- Troubleshooting.....159



### **The *Network Guide* (pdf)**

The *Network Guide* covers such topics as connecting the camera via Wi-Fi or Bluetooth to a computer or to a smart device such as a smartphone or tablet, and the tasks that can be performed using a WT-7 wireless transmitter.



**The Network Guide is available from the Nikon Download Center.**

nikon download center Z 7



Z 6



**Z 7:** [https://downloadcenter.nikonimglib.com/en/products/492/Z\\_7.html](https://downloadcenter.nikonimglib.com/en/products/492/Z_7.html)

**Z 6:** [https://downloadcenter.nikonimglib.com/en/products/493/Z\\_6.html](https://downloadcenter.nikonimglib.com/en/products/493/Z_6.html)

**Z 7 Model Name: N1710**

**Z 6 Model Name: N1711**

## ✓ **The Reference Manual (pdf)**

In addition to the material covered in the *User's Manual* (this manual), the *Reference Manual* details the options available in the camera menus and covers such topics as connecting the camera to other devices.



### **Among the topics covered in the Reference Manual are:**

- Basic shooting and playback operations
- Advanced shooting options
- The camera menus
- Connecting to computers, printers, and HDMI devices
- Flash photography using optional flash units



For information on wireless networks, see the *Network Guide*.

### **The Reference Manual is available from the Nikon Download Center in pdf format.**

nikon download center Z 7  Z 6

**Z 7:** [https://downloadcenter.nikonimglib.com/en/products/492/Z\\_7.html](https://downloadcenter.nikonimglib.com/en/products/492/Z_7.html)



**Z 6:** [https://downloadcenter.nikonimglib.com/en/products/493/Z\\_6.html](https://downloadcenter.nikonimglib.com/en/products/493/Z_6.html)



### **The Reference Manual can also be viewed online in html format.**

nikon online manual Z 7  Z 6

[https://onlinemanual.nikonimglib.com/z7\\_z6/en/](https://onlinemanual.nikonimglib.com/z7_z6/en/)



## Package Contents

Be sure all items listed here were included with your camera.



*BF-N1 body cap*



*DK-29 rubber eyecup  
(comes attached to  
camera,  188)*

*Camera*

*EN-EL15b rechargeable Li-ion  
battery with terminal cover*

*MH-25a battery charger (comes  
with either an AC wall adapter or  
power cable of a type and shape  
that varies with the country or  
region of sale)*

*AN-DC19 strap ( 27)*

*Warranty*

*User's Manual*

*EH-7P charging AC adapter (Z 7  
only; supplied with a plug  
adapter attached in countries or  
regions where required; shape  
depends on country of sale—  
 29)*

*HDMI/USB cable clip ( 190)*

*UC-E24 USB cable*

*BS-1 accessory shoe cover  
( 189)*

*Memory cards are sold separately. Purchasers of lens or mount adapter kits should confirm that the package contains a lens or mount adapter (manuals for the lens or adapter may also be provided).*

### The Nikon Download Center

In addition to the *Reference Manual*, you can also visit the Nikon download center to download product manuals, firmware updates, and software such as ViewNX-i.  
<https://downloadcenter.nikonimglib.com/>



## About This Manual

This manual is for use with both the Z 7 and Z 6. The illustrations show the Z 7.

### Symbols and Conventions

To make it easier to find the information you need, the following symbols and conventions are used:



This icon marks notes, information that should be read before using this product.



This icon marks tips, additional information you may find helpful when using this product.



This icon marks references to other sections in this manual.

Menu items, options, and messages that appear in the camera displays are shown in **bold**. Throughout this manual, the display in camera monitor and viewfinder during shooting is referred to as the “shooting display”; in most cases, the illustrations show the monitor.

This camera can be used with XQD and CFexpress Type B memory cards. In contexts where no distinction need be made between the two, both types are referred to throughout this manual as “memory cards”.

Throughout this manual, smartphones and tablets are referred to as “smart devices”.

### Camera Settings



The explanations in this manual assume that default settings are used.

#### **For Your Safety**

Before using the camera for the first time, read the safety instructions in “For Your Safety” (□ ix).

# Table of Contents

Package Contents.....	ii
For Your Safety.....	ix
Notices.....	xiii
<b>Getting to Know the Camera</b>	<b>1</b>
<hr/>	
Parts of the Camera.....	1
Camera Body.....	1
The Control Panel.....	5
The Monitor and Viewfinder .....	6
<b>Camera Controls</b> .....	<b>8</b>
The Viewfinder .....	8
The Monitor Mode Button .....	8
Touch Controls.....	10
The <b>DISP</b> Button .....	15
The Sub-Selector .....	17
The <b>AF-ON</b> Button.....	17
The Command Dials.....	17
The <b>MENU</b> Button .....	18
The <b>i</b> Button ( <b>Fn</b> Icon) .....	21
The Function Buttons ( <b>Fn1</b> and <b>Fn2</b> ) .....	24
<b>First Steps</b>	<b>27</b>
<hr/>	
<b>Attach the Camera Strap</b> .....	<b>27</b>
<b>Charge the Battery</b> .....	<b>28</b>
The Battery Charger .....	28
Charging AC Adapters.....	29
<b>Insert the Battery and a Memory Card</b> .....	<b>32</b>
<b>Attach a Lens</b> .....	<b>36</b>
<b>Choose a Language and Set the Clock</b> .....	<b>38</b>

<b>Basic Photography and Playback</b>	<b>41</b>
<hr/>	
Taking Photographs (AUTO Mode) .....	41
Shooting Movies (AUTO Mode) .....	45
Basic Playback.....	49
Viewing Movies .....	49
Deleting Unwanted Pictures .....	51
<b>Basic Settings</b>	<b>52</b>
<hr/>	
Focus.....	52
Choosing a Focus Mode .....	52
AF-Area Mode .....	54
The Touch Shutter .....	60
Manual Focus .....	62
White Balance .....	64
Silent Photography.....	68
Rating Pictures.....	70
Protecting Pictures from Deletion .....	71
<b>Shooting Controls</b>	<b>72</b>
<hr/>	
The Mode Dial .....	72
P: Programmed Auto .....	73
S: Shutter-Priority Auto .....	73
A: Aperture-Priority Auto.....	74
M: Manual.....	75
User Settings: <b>U1</b> , <b>U2</b> , and <b>U3</b> Modes.....	77
Long Time-Exposures (Mode <b>M</b> ) .....	80
The ISO (ISO Sensitivity) Button .....	82
Auto ISO Sensitivity Control .....	84
The  (Exposure Compensation) Button .....	85
The  (Release Mode/Self-Timer) Button.....	87
The Self-Timer .....	90

<b>The Sub-Selector.....</b>	<b>92</b>
Focus-Point Selection .....	92
Autoexposure (AE) Lock .....	92
Focus Lock .....	92
<b>The <i>i</i> Menu</b>	<b>95</b>
<hr/>	
<b>Using the <i>i</i> Menu .....</b>	<b>95</b>
<b>The Photo-Mode <i>i</i> Menu .....</b>	<b>96</b>
Set Picture Control.....	97
White Balance.....	101
Image Quality .....	107
Image Size.....	109
Flash Mode .....	110
Metering.....	111
Wi-Fi Connection.....	112
Active D-Lighting .....	113
Release Mode.....	114
Vibration Reduction .....	115
AF-Area Mode.....	116
Focus Mode .....	116
<b>The Movie-Mode <i>i</i> Menu .....</b>	<b>117</b>
Set Picture Control.....	118
White Balance.....	118
Frame Size, Frame Rate, and Movie Quality .....	119
Microphone Sensitivity .....	121
Choose Image Area .....	122
Metering.....	123
Wi-Fi Connection.....	123
Active D-Lighting .....	123
Electronic VR .....	123
Vibration Reduction .....	124
AF-Area Mode.....	124
Focus Mode .....	124



**Camera Menu**

More information on camera menus is available in a *Reference Manual*, available for download from:

**Z7:** [https://downloadcenter.nikonimglib.com/en/products/492/Z\\_7.html](https://downloadcenter.nikonimglib.com/en/products/492/Z_7.html)



**Z6:** [https://downloadcenter.nikonimglib.com/en/products/493/Z\\_6.html](https://downloadcenter.nikonimglib.com/en/products/493/Z_6.html)



You can also consult the online manual, located at:  
[https://onlinemanual.nikonimglib.com/z7\\_z6/en/](https://onlinemanual.nikonimglib.com/z7_z6/en/)



The Playback Menu: Managing Images.....	125
The Photo Shooting Menu: Shooting Options.....	127
The Movie Shooting Menu: Movie Shooting Options ...	135
Custom Settings: Fine-Tuning Camera Settings .....	141
The Setup Menu: Camera Setup.....	150
The Retouch Menu: Creating Retouched Copies .....	156
My Menu/ Recent Settings.....	158

**Troubleshooting****159**

<b>Problems and Solutions .....</b>	<b>160</b>
Battery/Display .....	160
Shooting .....	161
Playback .....	163
Bluetooth and Wi-Fi (Wireless Networks) .....	165
Miscellaneous .....	165
<b>Indicators and Error Messages .....</b>	<b>166</b>
Indicators .....	166
Error Messages.....	168

<b>The Camera Display and Control Panel</b> .....	<b>171</b>
The Monitor: Photo Mode.....	171
The Monitor: Movie Mode.....	176
The Viewfinder: Photo Mode .....	177
The Viewfinder: Movie Mode .....	179
The Control Panel.....	180
<b>The Nikon Creative Lighting System</b> .....	<b>181</b>
<b>Other Accessories</b> .....	<b>186</b>
Attaching a Power Connector and AC Adapter .....	191
<b>Caring for the Camera</b> .....	<b>193</b>
Storage.....	193
Cleaning.....	193
Image Sensor Cleaning .....	194
Manual Cleaning.....	197
<b>Caring for the Camera and Battery: Cautions</b> .....	<b>199</b>
<b>Specifications</b> .....	<b>204</b>
<b>NIKKOR Z 24–70mm f/4 S Lens User’s Manual</b> .....	<b>219</b>
<b>FTZ Mount Adapter User’s Manual</b> .....	<b>228</b>
<b>Approved Memory Cards</b> .....	<b>235</b>
<b>Memory Card Capacity</b> .....	<b>236</b>
<b>Battery Endurance</b> .....	<b>238</b>
<b>Notices</b> .....	<b>239</b>
<b>Bluetooth and Wi-Fi (Wireless LAN)</b> .....	<b>240</b>
<b>Index</b> .....	<b>244</b>

## For Your Safety

To prevent damage to property or injury to yourself or to others, read “For Your Safety” in its entirety before using this product.

Keep these safety instructions where all those who use this product will read them.

**⚠ DANGER:** Failure to observe the precautions marked with this icon carries a high risk of death or severe injury.

**⚠ WARNING:** Failure to observe the precautions marked with this icon could result in death or severe injury.

**⚠ CAUTION:** Failure to observe the precautions marked with this icon could result in injury or property damage.



### WARNING

- **Do not use while walking or operating a vehicle.**

Failure to observe this precaution could result in accidents or other injury.

- **Do not disassemble or modify this product. Do not touch internal parts that become exposed as the result of a fall or other accident.**

Failure to observe these precautions could result in electric shock or other injury.

- **Should you notice any abnormalities such as the product producing smoke, heat, or unusual odors, immediately disconnect the battery or power source.**

Continued operation could result in fire, burns or other injury.

- **Keep dry. Do not handle with wet hands. Do not handle the plug with wet hands.**

Failure to observe these precautions could result in fire or electric shock.

- **Do not let your skin remain in prolonged contact with this product while it is on or plugged in.**

Failure to observe this precaution could result in low-temperature burns.

- **Do not use this product in the presence of flammable dust or gas such as propane, gasoline or aerosols.**

Failure to observe this precaution could result in explosion or fire.

- **Do not directly view the sun or other bright light source through the lens.**

Failure to observe this precaution could result in visual impairment.

---

- **Do not aim the flash or AF-assist illuminator at the operator of a motor vehicle.**

Failure to observe this precaution could result in accidents.

---

- **Keep this product out of reach of children.**

Failure to observe this precaution could result in injury or product malfunction. In addition, note that small parts constitute a choking hazard. Should a child swallow any part of this product, seek immediate medical attention.

---

- **Do not entangle, wrap or twist the straps around your neck.**

Failure to observe this precaution could result in accidents.

---

- **Do not use batteries, chargers, or AC adapters not specifically designated for use with this product. When using batteries, chargers, and AC adapters designated for use with this product, do not:**
  - **Damage, modify, forcibly tug or bend the cords or cables, place them under heavy objects, or expose them to heat or flame.**
  - **Use travel converters or adapters designed to convert from one voltage to another or with DC-to-AC inverters.**

Failure to observe these precautions could result in fire or electric shock.

---

- **Do not handle the plug when charging the product or using the AC adapter during thunderstorms.**

Failure to observe this precaution could result in electric shock.

---

- **Do not handle with bare hands in locations exposed to extremely high or low temperatures.**

Failure to observe this precaution could result in burns, or frostbite.

---



## CAUTION

- **Do not leave the lens pointed at the sun or other strong light sources.** Light focused by the lens could cause fire or damage to product's internal parts. When shooting backlit subjects, keep the sun well out of the frame. Sunlight focused into the camera when the sun is close to the frame could cause fire.
-

- **Turn this product off when its use is prohibited. Disable wireless features when the use of wireless equipment is prohibited.**

The radio-frequency emissions produced by this product could interfere with equipment onboard aircraft or in hospitals or other medical facilities.

---

- **Remove the battery and disconnect the AC adapter if this product will not be used for an extended period.**

Failure to observe this precaution could result in fire or product malfunction.

---

- **Do not fire the flash in contact with or in close proximity to the skin or objects.**

Failure to observe this precaution could result in burns or fire.

---

- **Do not leave the product where it will be exposed to extremely high temperatures, for an extended period such as in an enclosed automobile or in direct sunlight.**

Failure to observe this precaution could result in fire or product malfunction.

---

- **Do not look directly at the AF-assist illuminator.**

Failure to observe this precaution could have adverse effects on vision.

---

- **Do not transport cameras or lenses with tripods or similar accessories attached.**

Failure to observe this precaution could result in injury or product malfunction.

---



## **DANGER (Batteries)**

- **Do not mishandle batteries.**

Failure to observe the following precautions could result in the batteries leaking, overheating, rupturing, or catching fire:

- Use only rechargeable batteries approved for use in this product.
  - Do not expose batteries to flame or excessive heat.
  - Do not disassemble.
  - Do not short-circuit the terminals by touching them to necklaces, hairpins, or other metal objects.
  - Do not expose batteries or the products in which they are inserted to powerful physical shocks.
  - Do not step on batteries, pierce them with nails, or strike them with hammers.
-

- **Charge only as indicated.**

Failure to observe this precaution could result in the batteries leaking, overheating, rupturing, or catching fire.

---

- **If battery liquid comes into contact with the eyes, rinse with plenty of clean water and seek immediate medical attention.**

Delaying action could result in eye injuries.

---



## **WARNING (Batteries)**

- **Keep batteries out of reach of children.**

Should a child swallow a battery, seek immediate medical attention.

---

- **Keep batteries out of reach of household pets and other animals.**

The batteries could leak, overheat, rupture, or catch fire if bitten, chewed, or otherwise damaged by animals.

---

- **Do not immerse batteries in water or expose to rain.**

Failure to observe this precaution could result in fire or product malfunction. Immediately dry the product with a towel or similar object should it become wet.

---

- **Discontinue use immediately should you notice any changes in the batteries, such as discoloration or deformation. Cease charging EN-EL15b rechargeable batteries if they do not charge in the specified period of time.**

Failure to observe these precautions could result in the batteries leaking, overheating, rupturing, or catching fire.

---

- **When batteries are no longer needed, insulate the terminals with tape.**

Overheating, rupture, or fire may result should metal objects come into contact with the terminals.

---

- **If battery liquid comes into contact with a person's skin or clothing, immediately rinse the affected area with plenty of clean water.**

Failure to observe this precaution could result in skin irritation.

---

## Notices

- No part of the manuals included with this product may be reproduced, transmitted, transcribed, stored in a retrieval system, or translated into any language in any form, by any means, without Nikon's prior written permission.
- Nikon reserves the right to change the appearance and specifications of the hardware and software described in these manuals at any time and without prior notice.
- Nikon will not be held liable for any damages resulting from the use of this product.
- While every effort has been made to ensure that the information in these manuals is accurate and complete, we would appreciate it were you to bring any errors or omissions to the attention of the Nikon representative in your area (address provided separately).

## **Notice Concerning Prohibition of Copying or Reproduction**

Note that simply being in possession of material that has been digitally copied or reproduced by means of a scanner, digital camera, or other device may be punishable by law.

- **Items prohibited by law from being copied or reproduced**

Do not copy or reproduce paper money, coins, securities, government bonds, or local government bonds, even if such copies or reproductions are stamped "Sample."

The copying or reproduction of paper money, coins, or securities which are circulated in a foreign country is prohibited.

Unless the prior permission of the government has been obtained, the copying or reproduction of unused postage stamps or post cards issued by the government is prohibited.

The copying or reproduction of stamps issued by the government and of certified documents stipulated by law is prohibited.

- **Cautions on certain copies and reproductions**

The government has issued cautions on copies or reproductions of securities issued by private companies (shares, bills, checks, gift certificates, etc.), commuter passes, or coupon tickets, except when a minimum of necessary copies are to be provided for business use by a company. Also, do not copy or reproduce passports issued by the government, licenses issued by public agencies and private groups, ID cards, and tickets, such as passes and meal coupons.

- **Comply with copyright notices**

Under copyright law, photographs or recordings of copyrighted works made with the camera cannot be used without the permission of the copyright holder. Exceptions apply to personal use, but note that even personal use may be restricted in the case of photographs or recordings of exhibits or live performances.



## Use Only Nikon Brand Electronic Accessories

Nikon cameras are designed to the highest standards and include complex electronic circuitry. Only Nikon brand electronic accessories (including chargers, batteries, AC adapters, and flash accessories) certified by Nikon specifically for use with this Nikon digital camera are engineered and proven to operate within the operational and safety requirements of this electronic circuitry.

The use of non-Nikon electronic accessories could damage the camera and may void your Nikon warranty. The use of third-party rechargeable Li-ion batteries not bearing the Nikon holographic seal shown at right could interfere with normal operation of the camera or result in the batteries overheating, igniting, rupturing, or leaking.

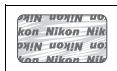

For more information about Nikon brand accessories, contact a local authorized Nikon dealer.

### ✔ Before Taking Important Pictures

Before taking pictures on important occasions (such as at weddings or before taking the camera on a trip), take a test shot to ensure that the camera is functioning normally. Nikon will not be held liable for damages or lost profits that may result from product malfunction.

### ✔ Life-Long Learning

As part of Nikon's "Life-Long Learning" commitment to ongoing product support and education, continually-updated information is available on-line at the following sites:

- **For users in the U.S.A.:** <https://www.nikonusa.com/>
- **For users in Europe and Africa:** <https://www.europe-nikon.com/support/>
- **For users in Asia, Oceania, and the Middle East:** <https://www.nikon-asia.com/>

Visit these sites to keep up-to-date with the latest product information, tips, answers to frequently-asked questions (FAQs), and general advice on digital imaging and photography. Additional information may be available from the Nikon representative in your area. See the following URL for contact information: <https://imaging.nikon.com/>



# Getting to Know the Camera

Take a few minutes to familiarize yourself with the names and functions of camera controls and displays. You may find it helpful to bookmark this section and refer to it as you read through the rest of the manual.

## Parts of the Camera

Refer to this section for the names and locations of camera controls and displays.

### Camera Body

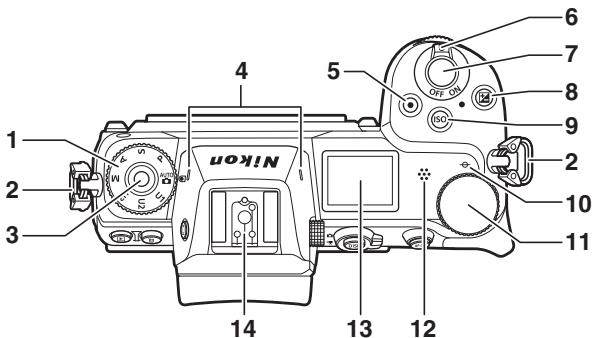

1	Mode dial .....	72	9	ISO button .....	82
2	Eyelet for camera strap .....	27	10	Focal plane mark (—) .....	63
3	Mode dial lock release .....	72	11	Main command dial .....	17
4	Stereo microphone .....	121	12	Speaker	
5	Movie-record button .....	45	13	Control panel .....	5, 151, 171
6	Power switch .....	38, 41	14	Accessory shoe (for optional flash unit) .....	181, 189
7	Shutter-release button .....	41			
8	☑ button .....	85			

## The Camera Body (Continued)

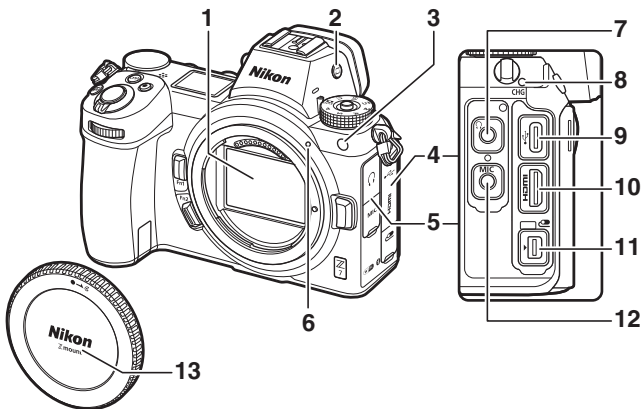

<b>1</b> Image sensor .....	194	<b>6</b> Lens mounting mark .....	36
<b>2</b> Monitor mode button .....	8, 151	<b>7</b> Headphone connector .....	140
<b>3</b> AF-assist illuminator .....	43, 142	<b>8</b> CHARGE lamp .....	29
Red-eye reduction lamp .....	110	<b>9</b> USB connector .....	186, 190
Self-timer lamp .....	90	<b>10</b> HDMI connector .....	186, 190
<b>4</b> Cover for accessory terminal and USB and HDMI connectors		<b>11</b> Accessory terminal .....	186
<b>5</b> Cover for headphone and microphone connectors		<b>12</b> Connector for external microphone .....	186
		<b>13</b> Body cap .....	36, 186

### **✓ Do Not Touch the Image Sensor**

Under no circumstances should you exert pressure on the image sensor, poke it with cleaning tools, or subject it to powerful air currents from a blower. These actions could scratch or otherwise damage the sensor. For information on cleaning the image sensor, see “Image Sensor Cleaning” (📖 194).

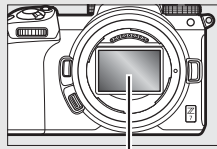

*Image sensor*

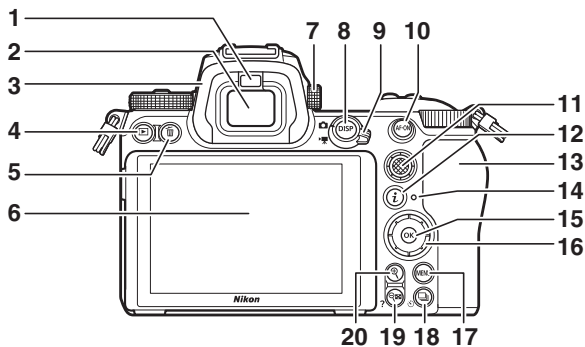

1	Eye sensor .....	8	11	Sub-selector .....	17, 92
2	Viewfinder .....	8	12	i button .....	21, 95
3	Viewfinder eyepiece .....	188	13	Memory card slot cover .....	32
4	▶ button .....	49	14	Memory card access lamp ....	44, 89
5	🗑 button .....	51	15	OK button .....	18
6	Monitor .....	6, 10	16	Multi selector .....	18
7	Diopter adjustment control .....	8	17	MENU button .....	18
8	DISP button .....	15	18	☺ button .....	87
9	Photo/movie selector .....	41, 45	19	? button .....	20
10	AF-ON button .....	17	20	🔍 button .....	62

### The Monitor

The angle of the monitor can be adjusted as shown.

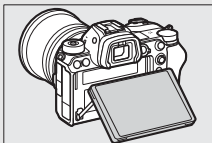
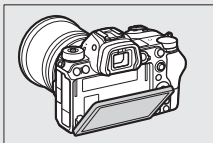

## The Camera Body (Continued)

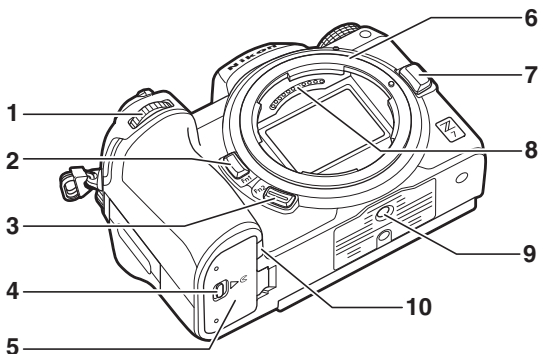

<b>1</b> Sub-command dial .....17	<b>6</b> Lens mount .....36
<b>2</b> Fn1 button .....24, 64	<b>7</b> Lens release button .....37
<b>3</b> Fn2 button .....24, 52	<b>8</b> CPU contacts
<b>4</b> Battery-chamber cover latch .....32	<b>9</b> Tripod socket .....80
<b>5</b> Battery-chamber cover .....32	<b>10</b> Power connector cover ..... 191

### **Product Serial Number**

The serial number for this product can be found by opening the monitor.

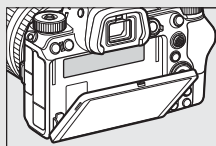

## The Control Panel

The control panel lights when the camera is on. At default settings, the following indicators are displayed; for a full list of the indicators that appear in the control panel, see “The Control Panel” (📖 180).

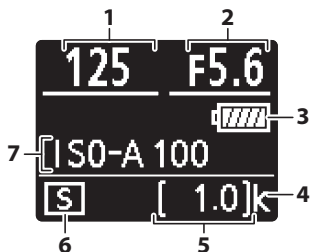

1	Shutter speed .....	73, 75	5	Number of exposures remaining .....	34, 236
2	Aperture.....	74	6	Release mode .....	87
3	Battery indicator .....	34	7	ISO sensitivity .....	82
4	“k” (appears when memory remains for over 1000 exposures) .....	34			

## The Monitor and Viewfinder

At default settings, the following indicators appear in the monitor and viewfinder in photo mode; for a full list of indicators, see “The Camera Display and Control Panel” (p 171).

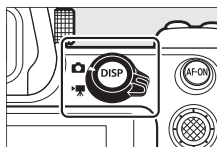

Monitor

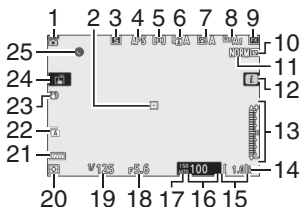

Viewfinder

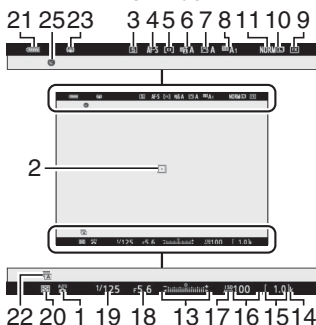

<b>1</b> Shooting mode .....72	<b>13</b> Exposure indicator .....76
<b>2</b> Focus point.....43, 54	Exposure compensation display .....85
<b>3</b> Release mode .....87, 114	<b>14</b> “k” (appears when memory remains for over 1000 exposures) .....34
<b>4</b> Focus mode.....52, 133, 139	<b>15</b> Number of exposures remaining .....34, 236
<b>5</b> AF-area mode .....54, 133, 139	<b>16</b> ISO sensitivity .....82
<b>6</b> Active D-Lighting ..... 113, 131, 138	<b>17</b> ISO sensitivity indicator .....82
<b>7</b> Picture Control .....97, 130, 137	Auto ISO sensitivity indicator .....84
<b>8</b> White balance .....64, 101, 129, 136	
<b>9</b> Image area ..... 122, 127, 135	
<b>10</b> Image size..... 109, 128	
<b>11</b> Image quality ..... 107, 128	
<b>12</b> icon..... 13, 21	



<b>18</b> Aperture..... 74	<b>23</b> Vibration reduction indicator..... 115, 133
<b>19</b> Shutter speed .....73, 75	<b>24</b> Touch shooting ..... 10, 60
<b>20</b> Metering ..... 111, 132, 139	<b>25</b> “Clock not set” indicator ..... 40
<b>21</b> Battery indicator ..... 34	
<b>22</b> Shutter type ..... 144	

The following items appear in movie mode.

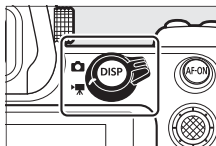

**Monitor**

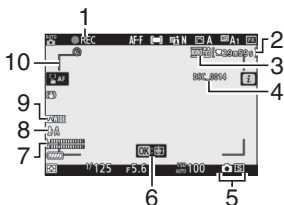

**Viewfinder**

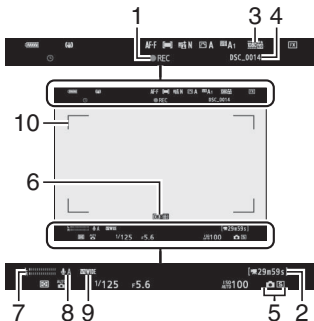

<b>1</b> Recording indicator..... 45	<b>5</b> Release mode (still photography)..... 87
Recording disabled ..... 46	<b>6</b> Subject tracking..... 59
<b>2</b> Time remaining ..... 45	<b>7</b> Sound level ..... 121
<b>3</b> Frame size and rate/ image quality ..... 119, 135, 136	<b>8</b> Microphone sensitivity..... 121, 140
<b>4</b> File name ..... 135	<b>9</b> Frequency response..... 140
	<b>10</b> AF-area brackets ..... 54

## Camera Controls

This section outlines how to use various camera controls and displays.

### The Viewfinder

Placing your eye to the viewfinder activates the eye sensor, switching the display from the monitor to the viewfinder (note that the eye sensor will also respond to other objects, such as your fingers). The viewfinder can be used for menus and playback if desired.

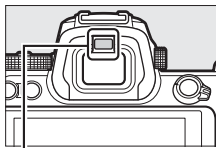

*Eye sensor*

### The Monitor Mode Button

Press the monitor mode button to cycle between viewfinder and monitor displays.



### The Diopter Adjustment Control

To focus the viewfinder, lift and rotate the diopter adjustment control, being careful not to put your fingers or fingernails in your eye. Push the control back in once focus is adjusted to your satisfaction.

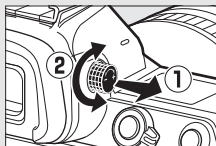

### Extended Use

When using the viewfinder for extended periods, you can adjust viewfinder brightness and hue for ease of viewing by selecting **Off** for Custom Setting d8 (**Apply settings to live view**).

### Monitor Mode

You can limit the choice of monitor modes available using the **Limit monitor mode selection** option in the setup menu.

Press the monitor mode button to cycle through the displays as follows.

---

**Automatic display switch:** The display switches from the monitor to the viewfinder when you place your eye to the viewfinder, and from the viewfinder to the monitor when you take your eye away.

---



▼

**Viewfinder only:** The viewfinder is used for shooting, menus, and playback; the monitor remains blank.

---



▼

**Monitor only:** The monitor is used for shooting, menus, and playback; the viewfinder display will remain blank even if you put your eye to the viewfinder.

---



▼

**Prioritize viewfinder:** The camera functions in a manner similar to existing digital SLR cameras. Placing your eye to the viewfinder turns the viewfinder on and taking your eye away turns the viewfinder off. In photo mode, the monitor remains blank, while in movie mode, during playback, or while menus are displayed, the monitor will turn on when you take your eye away from the viewfinder.

---



## **Touch Controls**

The touch-sensitive monitor can be used to adjust camera settings, focus and release the shutter, view photos and movies, enter text, and navigate the menus. Touch controls are not available while the viewfinder is in use.

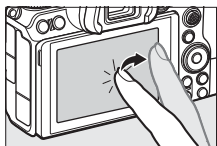

### **■ ■ *Focusing and Releasing the Shutter***

Touch the monitor to focus on the selected point (touch AF). In photo mode, the shutter will be released when you lift your finger from the display (touch shutter).



Touch AF settings can be adjusted by tapping the  icon (□ 60).



## ■ ■ Adjusting Settings

Tap highlighted settings in the display and choose the desired option by tapping icons or sliders. Tap **↩** or press **OK** to select the chosen option and return to the previous display.

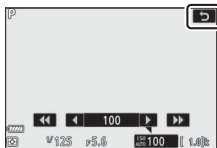

## ■ ■ Playback

Flick left or right to view other pictures during full-frame playback.

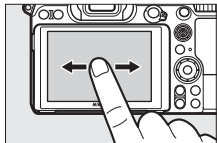

In full-frame view, touching the bottom of the display brings up a frame-advance bar. Slide your finger left or right over the bar to scroll rapidly to other pictures.

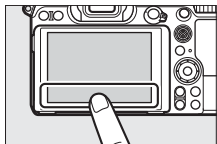

Frame advance bar

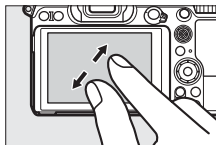

Use stretch and pinch gestures to zoom in and out and slide to scroll. You can also give the display two quick taps to zoom in from full-frame playback or cancel zoom.

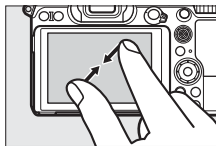

To “zoom out” to a thumbnail view, use a pinch gesture in full-frame playback. Use pinch and stretch to choose the number of images displayed from 4, 9, and 72 frames.



### ■ **Movie Playback**

Tap the on-screen guide to start movie playback (movies are indicated by a  icon). Tap the display to pause or resume, or tap  to exit to full-frame playback.



*Guide*

## ■ ■ The *i* Menu

Tap the  icon to display the *i* menu during shooting (📖 21, 95).



Tap items to view options.

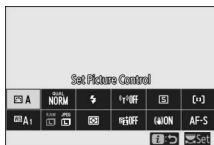

## ■ ■ Text Entry

When a keyboard is displayed, you can enter text by tapping the keys (to cycle through the upper- and lower-case and symbol keyboards, tap the keyboard selection button) or move the cursor by tapping in the text display area.

*Text display area*

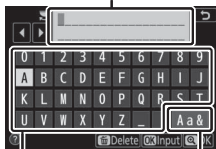

*Keyboard area*

*Keyboard selection*

## ■ Navigating the Menus

Slide up or down to scroll.

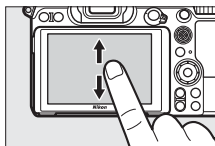

Tap a menu icon to choose a menu.

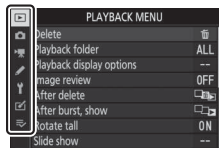

Tap menu items to display options and tap icons or sliders to change.

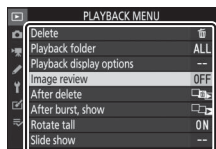

To exit without changing settings, tap .

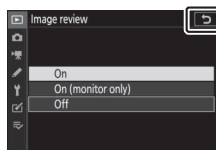

### ✓ The Touch Screen

The touch screen responds to static electricity and may not respond when covered with third-party protective films, when touched with fingernails or gloved hands, or when touched simultaneously in multiple locations. Do not use excessive force or touch the screen with sharp objects.

### ✎ Enabling or Disabling Touch Controls

Touch controls can be enabled or disabled using the **Touch controls** option in the setup menu (📖 152).



## The DISP Button

Use the **DISP** button to view or hide indicators in the monitor or viewfinder.

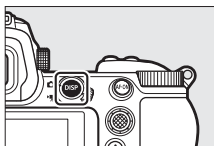

### ■ Photo Mode

In photo mode, pressing the **DISP** button cycles the display as follows:

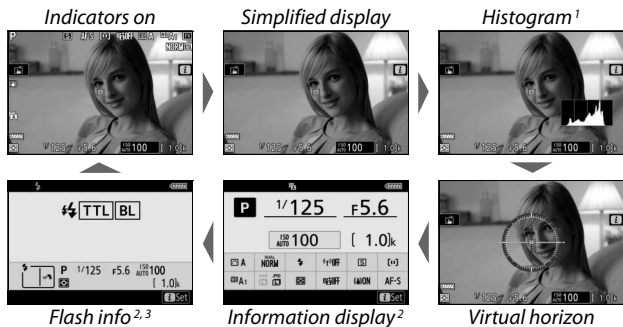

- 1 Not displayed when **Off** is selected for Custom Setting d8 (**Apply settings to live view**) or **On** is selected for **Overlay shooting** in multiple exposure mode.
- 2 Not displayed in the viewfinder.
- 3 Displayed when an optional SB-5000, SB-500, SB-400, or SB-300 flash unit is mounted on the accessory shoe or a WR-R10 wireless remote controller commands a flash unit via radio flash control.

## ■ ■ *Movie Mode*

In movie mode, pressing the **DISP** button cycles the display as follows:

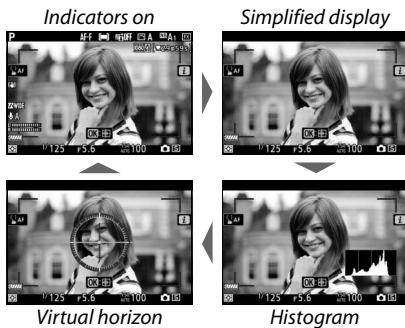

## The Sub-Selector

Use the sub-selector as a joystick to select the focus point, or press the center of the sub-selector to lock focus and exposure (📖 92, 93).

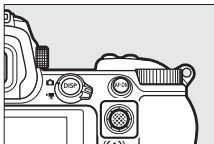

## The AF-ON Button

In autofocus mode, the **AF-ON** button can be used to focus.

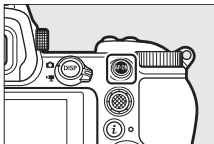

## The Command Dials

Use the command dials to adjust shutter speed or aperture or in combination with other buttons to change camera settings.

*Sub-command dial*

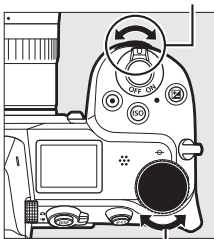

*Main command dial*

## The MENU Button

Press the MENU button to view the menus.

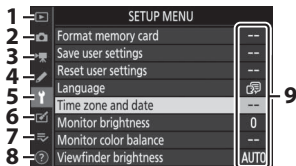
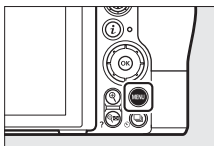

1	▶: Playback menu .....	125
2	📷: Photo shooting menu.....	127
3	🎬: Movie shooting menu .....	135
4	🔧: Custom Settings menu.....	141
5	⚙️: Setup menu .....	150
6	🔍: Retouch menu.....	156
7	🏠/🔄: My Menu or recent settings (defaults to My Menu) .....	158
8	❓: Help icon .....	20
9	Current settings .....	125

## Using the Menus

You can navigate the menus using the multi selector and **OK** button.

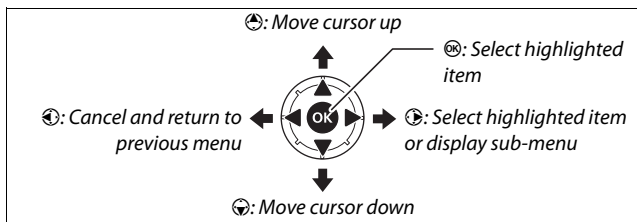

# 1 Highlight the icon for the current menu.

Press  to highlight the icon for the current menu.

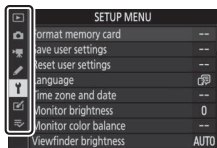

# 2 Select a menu.

Press  or  to select the desired menu.



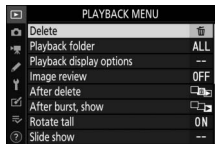

# 3 Position the cursor in the selected menu.

Press  to position the cursor in the selected menu.



# 4 Highlight a menu item.

Press  or  to highlight a menu item (items that are displayed in gray are not currently available and cannot be selected).

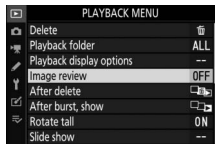

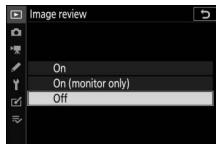

## 5 Display options.

Press  to display options for the selected menu item.



## 6 Highlight an option.

Press  or  to highlight an option (options that are displayed in gray are not currently available and cannot be selected).

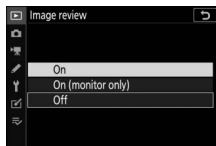





## 7 Select the highlighted item.

Press  to select the highlighted item. To exit without making a selection, press the MENU button. To exit the menus and return to shooting mode, press the shutter-release button halfway.



You can also navigate the menus using touch controls ( 14).

### The (Help) Icon

If a  icon appears at the bottom left corner of the display, you can view a description of the currently selected option or menu by pressing the  (?). Press  or  to scroll the text, or press  (?) again to return to the menus.

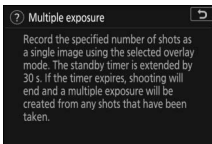
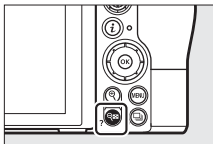

## The **i** Button (**i** Icon)

For quick access to frequently-used settings, press the **i** button or tap the **i** icon in the display.



Tap the desired item or highlight items and press **OK** to view options. You can also adjust settings by highlighting items and rotating the command dials. The items displayed in photo mode (📖 96) differ from those displayed in movie mode (📖 117).

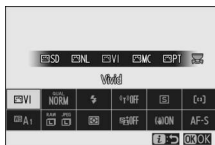
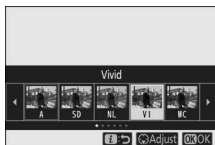

### **i** The Playback **i** Menu

Pressing the **i** button during playback displays a context-sensitive menu of frequently-used playback options.

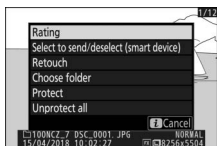

## ■ Customizing the *i* Menu

The items displayed in the photo-mode *i* menu can be chosen using Custom Setting f1 (**Customize *i* menu**).

### 1 Select Custom Setting f1.

In the Custom Settings menu, highlight Custom Setting f1 (**Customize *i* menu**) and press **OK** (for information on using the menus, see “The MENU Button”, [p. 18](#)).



### 2 Choose a position.

Highlight a position in the menu you want to edit and press **OK**.



### 3 Choose an option.

Highlight an option and press **OK** to assign it to the selected position and return to the menu displayed in Step 2. Repeat Steps 2 and 3 as desired.

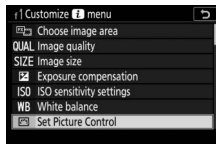

### 4 Exit.

Press the **MENU** button to save changes and exit.



### Options That Can Be Assigned to the **i** Menu

The following options can be assigned to the **i** menu for photo mode:

- Choose image area
- Image quality
- Image size
- Exposure compensation
- ISO sensitivity settings
- White balance
- Set Picture Control
- Color space
- Active D-Lighting
- Long exposure NR
- High ISO NR
- Metering
- Flash mode
- Flash compensation
- Focus mode
- AF-area mode
- Vibration reduction
- Auto bracketing
- Multiple exposure
- HDR (high dynamic range)
- Silent photography
- Release mode
- Custom control assignment
- Exposure delay mode
- Shutter type
- Apply settings to live view
- Split-screen display zoom
- Peaking highlights
- Monitor/viewfinder brightness
- Bluetooth connection
- Wi-Fi connection

The movie-mode **i** menu can be customized using Custom Setting g1 (**Customize  menu**); the options available differ from those for photo mode.

## The Function Buttons (Fn1 and Fn2)

The **Fn1** and **Fn2** buttons can also be used for quick access to selected settings during shooting. The settings assigned to these buttons can be chosen using Custom Setting f2 (**Custom control assignment**) and the selected setting adjusted by pressing the button and rotating the command dials. At default settings, the **Fn1** button is used for white balance and the **Fn2** button to select focus and AF-area modes.

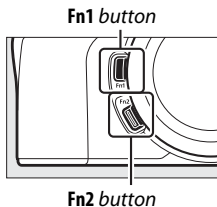

### ■ Customizing the Function Buttons

The function performed by the function buttons in photo mode are chosen using Custom Setting f2 (**Custom control assignment**).

#### 1 Select Custom Setting f2.

In the Custom Settings menu, highlight Custom Setting f2 (**Custom control assignment**) and press **OK** (for information on using the menus, see “The MENU Button”, [p 18](#)).



---

## 2 Choose a button.

Highlight the option for the desired button and press **OK**. Select **Fn1 button** to choose the role played by the **Fn1 button**, **Fn2 button** to choose the role played by the **Fn2 button**.



---

## 3 Choose an option.

Highlight an option and press **OK** to assign it to the selected button and return to the menu displayed in Step 2. Repeat Steps 2 and 3 to choose the role played by the remaining button.

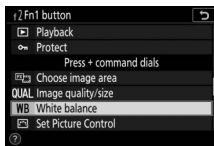

---

## 4 Exit.

Press the **MENU** button to save changes and exit.

### Roles That Can Be Assigned to the Function Buttons

The following roles can be assigned to the function buttons in photo mode:

- AF-ON
- AF lock only
- AE lock (Hold)
- AE lock (Reset on release)
- AE lock only
- AE/AF lock
- FV lock
-  Disable/enable
- Preview
- Matrix metering
- Center-weighted metering
- Spot metering
- Highlight-weighted metering
- Bracketing burst
- Sync. release selection
- + NEF (RAW)
- Subject tracking
- Framing grid display
- Zoom on/off
- MY MENU
- Access top item in MY MENU
- Playback
- Protect
- Choose image area
- Image quality/size
- White balance
- Set Picture Control
- Active D-Lighting
- Metering
- Flash mode/compensation
- Focus mode/AF-area mode
- Auto bracketing
- Multiple exposure
- HDR (high dynamic range)
- Exposure delay mode
- Shutter spd & aperture lock
- Peaking highlights
- Rating
- Choose non-CPU lens number
- None

The roles played by the function buttons in movie mode can be chosen using Custom Setting g2 (**Custom control assignment**); the options available differ from those for photo mode.

# First Steps

Complete the steps in this chapter before taking pictures for the first time.

## Attach the Camera Strap

A strap is supplied with the camera; additional straps are available separately. Attach the strap securely to the camera eyelets.

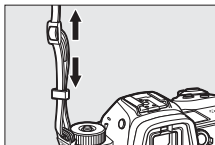
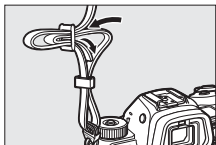
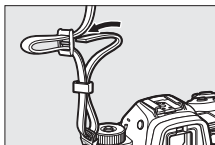
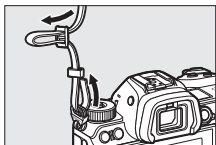

## Charge the Battery

The battery can be charged using the supplied battery charger or an EH-7P charging AC adapter (an EH-7P is supplied with the Z 7, and can be purchased separately for the Z 6).

### ✔ The Battery and Charger

Read and follow the warnings and cautions in "For Your Safety" (ix) and "Caring for the Camera and Battery: Cautions" (199).

## The Battery Charger

Insert the supplied EN-EL15b battery and plug the charger in. Depending on the country or region, the charger comes with either an AC wall adapter or a power cable.

- **AC wall adapter:** Insert the AC wall adapter into the charger AC inlet (1). Slide the AC wall adapter latch as shown (2) and rotate the adapter 90° to fix it in place (3). Insert the battery and plug the charger in.

AC wall adapter latch

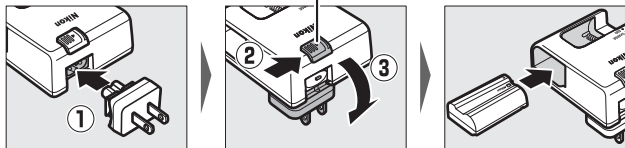

- **Power cable:** After connecting the power cable with the plug in the orientation shown, insert the battery and plug the cable in.

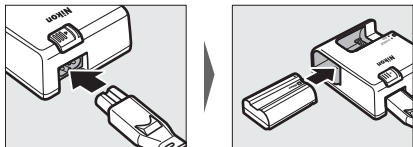

The **CHARGE** lamp will flash while the battery charges. An exhausted battery will fully charge in about two hours and 35 minutes.

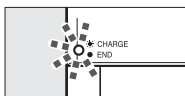

*Battery charging*

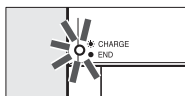

*Charging complete*

## **Charging AC Adapters**

When inserted in the camera, EN-EL15b rechargeable Li-ion batteries will charge while the camera is connected to an EH-7P charging AC adapter (the EH-7P cannot be used to charge EN-EL15a and EN-EL15 batteries; use the supplied MH-25a battery charger instead). An exhausted battery will fully charge in about two hours and 35 minutes. Note that in countries or regions where required, charging AC adapters are supplied with a plug adapter attached; the shape of the plug adapter varies with the country of sale.

- 1** Insert the EN-EL15b into the camera (📖 32).

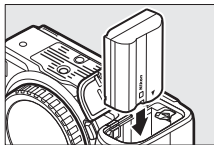

- 
- 2** After confirming that the camera is off, connect the charging AC adapter and plug the adapter in. Insert the plug or plug adapter straight into the socket rather than at an angle, and observe the same precaution when unplugging the charging AC adapter.

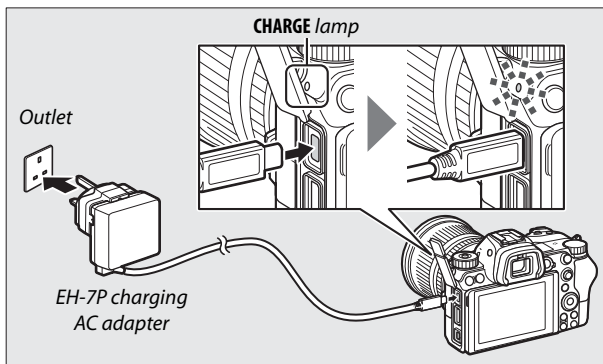

The camera **CHARGE** lamp lights amber while charging is in progress and turns off when charging is complete. Note that although the camera can be used while connected, the battery will not charge and the camera will not draw power from the charging AC adapter while the camera is on.

- 
- 3** Unplug and disconnect the charging AC adapter when charging is complete.



### **The CHARGE Lamp**

If the battery cannot be charged using the charging AC adapter, for example because the battery is not compatible or the temperature of the camera is elevated, the **CHARGE** lamp will flash rapidly for about 30 seconds and then turn off. If the **CHARGE** lamp is off and you did not observe the battery charging, turn the camera on and check the battery level.

## Insert the Battery and a Memory Card

Before inserting or removing the battery or memory cards, confirm that the camera power switch is in the **OFF** position. Insert the battery in the orientation shown, using the battery to keep the orange battery latch pressed to one side. The latch locks the battery in place when the battery is fully inserted.

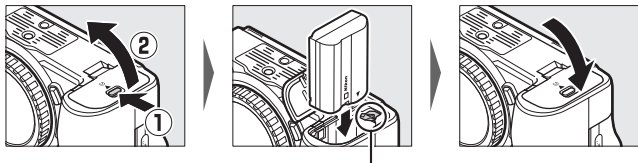

*Battery latch*

Holding the memory card in the orientation shown, slide it straight into the slot until it clicks into place.

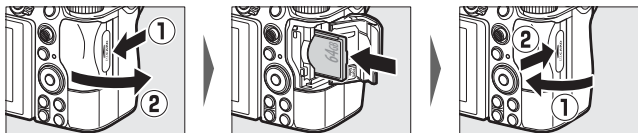

### ✔ Removing the Battery

To remove the battery, turn the camera off and open the battery-chamber cover. Press the battery latch in the direction shown by the arrow to release the battery and then remove the battery by hand.

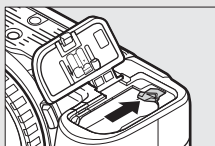

### ✔ Removing Memory Cards

After confirming that the memory card access lamp is off, turn the camera off, open the memory card slot cover, and press the card in to eject it (①). The card can then be removed by hand (②).

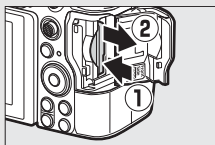

## Battery Level

The battery level is shown in the shooting display and control panel while the camera is on.

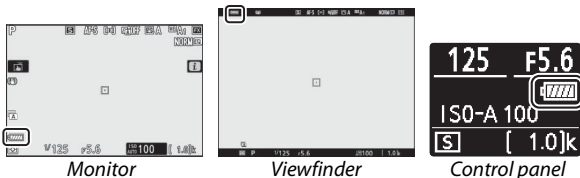

The battery level display changes as the battery level diminishes, from through , , and finally, . When the battery level falls to , suspend shooting and charge the battery or ready a spare battery. When the battery is exhausted, the icon will flash; charge the battery or insert a fully-charged spare battery.

## Number of Exposures Remaining

When the camera is on, the shooting display and control panel show the number of photographs that can be taken at current settings (values over 1000 are rounded down to the nearest hundred; e.g., values between 1400 and 1499 are shown as 1.4 k).

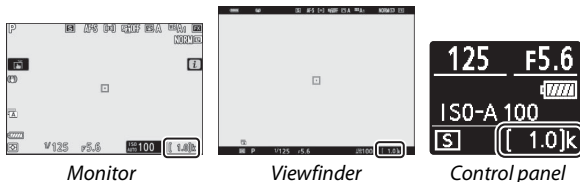

### **✔ Memory Cards**

- Memory cards may be hot after use. Observe due caution when removing memory cards from the camera.
- Turn the power off before inserting or removing memory cards. Do not remove memory cards from the camera, turn the camera off, or remove or disconnect the power source during formatting or while data are being recorded, deleted, or copied to a computer or other device. Failure to observe these precautions could result in loss of data or in damage to the camera or card.
- Do not touch the card terminals with your fingers or metal objects.
- Do not bend, drop, or subject to strong physical shocks.
- Do not apply force to the card casing. Failure to observe this precaution could damage the card.
- Do not expose to water, heat, high levels of humidity, or direct sunlight.
- Do not format memory cards in a computer.

### **✔ No Memory Card**

If no memory card is inserted, a “no memory card” indicator will appear in the shooting display and [-E-] will appear in both the control panel and the shooting display.

## Attach a Lens

The camera can be used with Z mount lenses. Before attaching or removing lenses, confirm that the camera power switch is in the **OFF** position. Be careful to prevent dust from entering the camera when the lens or body cap is removed, and be sure to remove the lens cap before taking pictures. The lens generally used in this manual for illustrative purposes is a NIKKOR Z 24–70mm f/4 S.

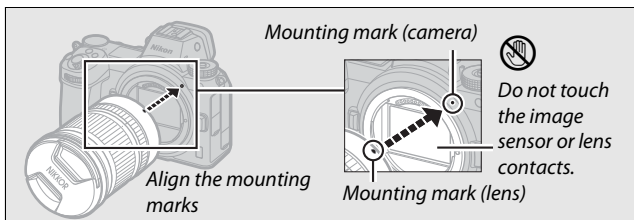
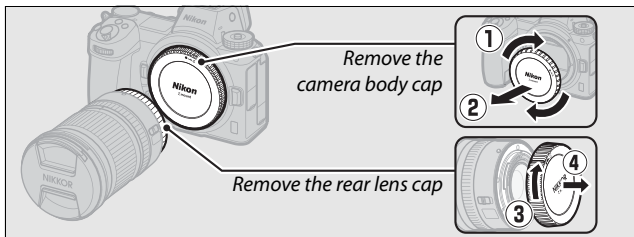

### ✓ F Mount Lenses

Be sure to attach the FTZ mount adapter (supplied or available separately, □ 228) before using F mount lenses. Attempting to attach F mount lenses directly to the camera could damage the lens or image sensor.

### ✓ Detaching Lenses

Be sure the camera is off when removing or exchanging lenses. To remove the lens, press and hold the lens release button (①) while turning the lens clockwise (②). After removing the lens, replace the lens caps and camera body cap.

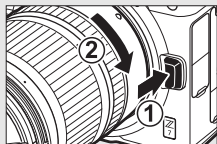

## Choose a Language and Set the Clock

The language option in the setup menu is automatically highlighted the first time menus are displayed. Choose a language and set the camera clock.

### 1 Turn the camera on.

Rotate the power switch to **ON**.

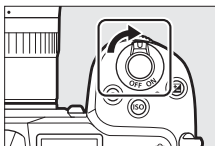

### 2 Select Language in the setup menu.

Press the **MENU** button to display the camera menus, then highlight **Language** in the setup menu and press **OK** (for information on using menus, see “The MENU Button”, [book 18](#)).

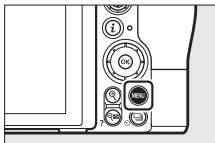

### 3 Select a language.

Press **▲** or **▼** to highlight the desired language and press **OK** (the languages available vary with the country or region in which the camera was originally purchased).



## 4 Select Time zone and date.

Highlight **Time zone and date** and press .



## 5 Choose a time zone.

Select **Time zone** and choose your current time zone (the display shows selected cities in the chosen zone and the difference between the time in the chosen zone and UTC). Press  to save changes and return to the time zone and date menu.

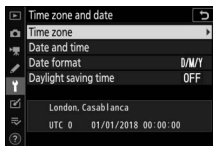

## 6 Turn daylight saving time on or off.

Select **Daylight saving time**, then highlight **On** or **Off** and press . Selecting **On** advances the clock by one hour.

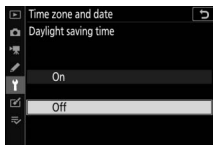

## 7 Set the clock.

Select **Date and time** and use the multi selector to set the clock. Press  when the clock is set to the current date and time (note that the camera uses a 24-hour clock).

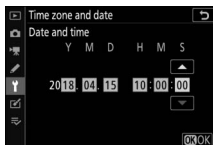

## 8 Choose a date format.

To choose the order in which the year, month, and day are displayed, select

**Date format**, then highlight the desired option and press **OK**.

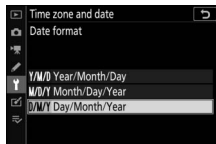

## 9 Exit to shooting mode.

Press the shutter-release button halfway to exit to shooting mode.



### **The ☹ (“Clock Not Set”) Icon**

The camera clock is powered by an independent, rechargeable power source, which is charged as necessary when the main battery is installed. Two days of charging will power the clock for about a month. If a ☹ icon flashes in the display, the clock has been reset and the date and time recorded with new photographs will not be correct. Use the **Time zone and date > Date and time** option in the setup menu to set the clock to the correct time and date (☞ 151).

### **SnapBridge**

Use the SnapBridge app to synchronize the camera clock with the clock on a smartphone or tablet (smart device). See SnapBridge online help for details.

# Basic Photography and Playback

This chapter explains the basics of taking and viewing photos.

## Taking Photographs (AUTO Mode)

Follow the steps below to take photographs in <sup>AUTO</sup> (auto) mode, an automatic “point-and-shoot” mode in which the majority of settings are controlled by the camera in response to shooting conditions.

### 1 Turn the camera on.

The monitor and control panel will light.



### 2 Select photo mode.

Rotate the photo/movie selector to .

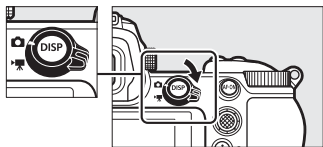

### Lenses with Retractable Barrels

Lenses with retractable barrels must be extended before use. Rotate the lens zoom ring as shown until the lens clicks into the extended position.

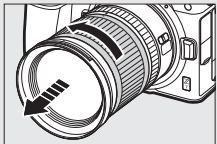

### 3 Select mode.

Pressing the mode dial lock release on top of the camera, rotate the mode dial to .

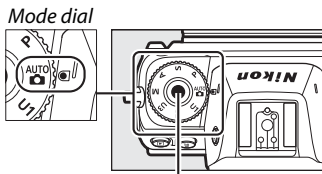

*Mode dial lock release*

### 4 Ready the camera.

Hold the handgrip in your right hand and cradle the camera body or lens with your left. Bring your elbows in against the sides of your chest.

*Framing photos in the viewfinder*



*Landscape (wide) orientation*



*Portrait (tall) orientation*

*Framing photos in the monitor*



*Landscape (wide) orientation*



*Portrait (tall) orientation*



## 7 Shoot.

Smoothly press the shutter-release button the rest of the way down to take the photograph (you can also take a photograph by touching the monitor: touch your subject to focus and lift your finger to release the shutter). The memory card access lamp will light while the photo is recorded to the memory card. *Do not eject the memory card or remove or disconnect the power source until the lamp has gone out and recording is complete.*

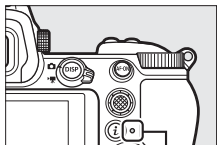

Memory card  
access lamp

### **✓ The Standby Timer**

If no operations are performed for about 30 seconds, the display will dim for a few seconds before the monitor, viewfinder, and control panel turn off to reduce the drain on the battery. Press the shutter-release button halfway to reactivate the display. The length of time before the standby timer expires automatically can be selected using Custom Setting c3 (**Power off delay**) > **Standby timer**.

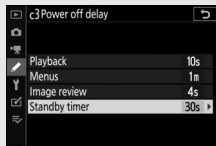

## Shooting Movies (AUTO Mode)

**AUTO** (auto) mode can also be used for simple, “point-and-shoot” movie recording.

### 1 Turn the camera on.

The monitor and control panel will light.

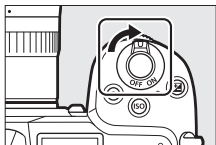

### 2 Select movie mode.

Rotate the photo/movie selector to . Note that optional flash units cannot be used when the camera is in movie mode.

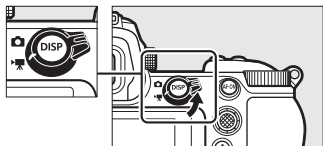

### 3 Select **AUTO** mode.

Pressing the mode dial lock release on top of the camera, rotate the mode dial to **AUTO**.

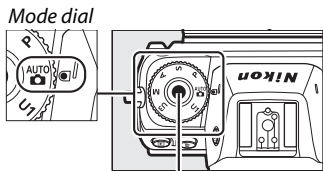

*Mode dial lock release*

## 4 Start recording.

Press the movie-record button to start recording. While recording is in progress, the camera will display a recording indicator and the time remaining. The camera can be refocused at any time during recording by pressing the **AF-ON** button or tapping your subject in the display. Sound is recorded via the built-in microphone; do not cover the microphone during recording.

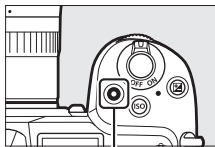

Movie-record button

Recording indicator



Time remaining

## 5 End recording.

Press the movie-record button again to end recording. The memory card access lamp will light while the camera finishes saving the movie to the memory card. *Do not eject the memory card or remove or disconnect the power source until the lamp has gone out and recording is complete.*

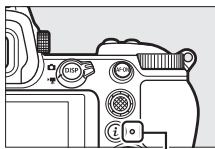
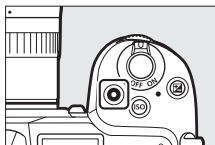

Memory card  
access lamp

### ✓ The Icon

A  icon indicates that movies cannot be recorded.



In movie mode, photos can be taken without interrupting recording by pressing the shutter-release button all the way down. A  icon will flash in the display when a photo is taken.



### Taking Photos in Movie Mode

Note that photos can be taken even when the subject is not in focus. Photos are recorded in fine★-quality JPEG format at the dimensions currently selected for movie frame size. In continuous release modes, the frame advance rate while recording is paused varies with the option selected for **Frame size/frame rate**, but only one photo will be taken each time the shutter-release button is pressed while recording is in progress. Up to 50 photographs can be taken with each movie.

### During Shooting

Flicker, banding, or distortion may be visible in the display and in photos and movies shot under fluorescent, mercury vapor, or sodium lamps or with subjects that are in motion, particularly if the camera is panned horizontally or an object moves horizontally at high speed through the frame. Jagged edges, color fringing, *moiré*, and bright spots may also appear. Bright regions or bands may appear in some areas of the frame with flashing signs and other intermittent light sources or if the subject is briefly illuminated by a strobe or other bright, momentary light source, while noise (randomly-spaced bright pixels, fog, or lines) and unexpected colors may appear if you zoom in on the view through the lens. Flicker may occur when power aperture is used during movie recording.

Avoid pointing the camera at the sun or other strong light sources. Failure to observe this precaution could result in damage to the camera's internal circuitry.

### **Recording Movies**

Recording ends automatically when the maximum length is reached or the memory card fills or if the lens is removed, another mode is selected, or the photo/movie selector is rotated to . Note that the built-in microphone may record sounds made by the camera or lens during vibration reduction, autofocus, or changes to aperture.

## Basic Playback



Photographs and movies can be viewed on the camera.

### 1 Press the button.

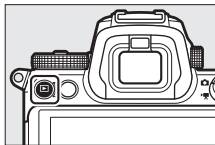
A picture will appear in the display.





### 2 View additional pictures.

Press  or  to view additional pictures. When pictures are displayed in the monitor, you can view other pictures by flicking a finger left or right over the display. To end playback and return to shooting mode, press the shutter-release button halfway.



## Viewing Movies



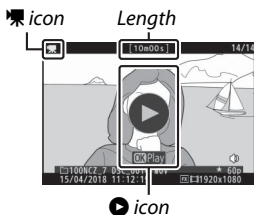



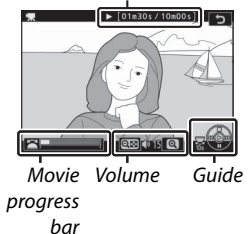





Movies are indicated by a  icon. Tap the  icon in the display or press  to start playback; your current position is shown on the movie progress bar.



Current position/total length



The following operations can be performed:

Operation	Description
Pause	Press  to pause playback.
Play	Press  to resume playback when playback is paused or during rewind/advance.
Rewind/advance	Press  to rewind,  to advance. Speed increases with each press, from 2x to 4x to 8x to 16x; keep the control pressed to skip to the beginning or end of the movie (the first frame is indicated by a  in the top right corner of the display, the last frame by a  ). If playback is paused, the movie rewinds or advances one frame at a time; keep the control pressed for continuous rewind or advance.
Start slow-motion playback	Press  while the movie is paused to start slow-motion playback.
Skip 10 s	Rotate the main command dial one stop to skip ahead or back 10 s.
Skip to last or first frame	Rotate the sub-command dial to skip to the last or first frame.
Adjust volume	Press  to increase volume,  (?) to decrease.
Trim movie	To view movie editing options, pause playback and press the  button.
Exit	Press  or  to exit to full-frame playback.
Return to shooting mode	Press the shutter-release button halfway to exit to shooting mode.

## Deleting Unwanted Pictures



Press the  button to delete the current picture. *Note that pictures cannot be recovered once deleted.*

### 1 Display a picture you wish to delete.

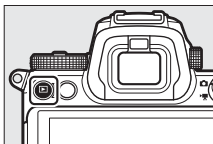
Display a photo or movie you wish to delete as described in “Basic Playback” (📖 49).



### 2 Delete the picture.

Press the  button. A confirmation dialog will be displayed; press the  button again to delete the picture and return to playback. To exit without deleting the picture, press .

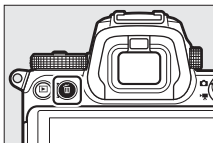

#### Delete

To delete selected pictures, all pictures taken on selected dates, or all pictures in a chosen location on the memory card, use the **Delete** option in the playback menu.

# Basic Settings

This chapter covers basic shooting and playback settings.

## Focus

Focus can be adjusted automatically, manually, or using touch controls. How the camera focuses is governed by your choice of focus mode and AF-area mode.

### Choosing a Focus Mode

The focus mode controls how the camera focuses. The focus mode can be selected using the **Focus mode** items in the **i** menu and the photo and movie shooting menus (☞ 116, 133, 139).



At default settings, the focus mode can also be selected by holding the **Fn2** button and rotating the main command dial (☞ 24).

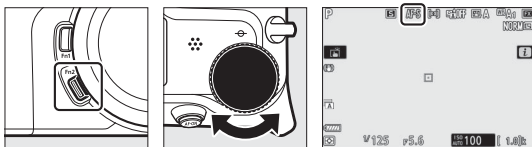

Option	Description
<b>AF-S Single AF</b>	For stationary subjects. Press the shutter-release button halfway to focus. If the camera is able to focus, the focus point will turn from red to green; focus will lock while the shutter-release button is pressed halfway. If the camera fails to focus, the focus point will flash red. At default settings, the shutter can only be released if the camera is able to focus (focus priority).

Option	Description
<b>AF-C</b> Continuous AF	For moving subjects. The camera focuses continuously while the shutter-release button is pressed halfway; if the subject moves, the camera will predict the final distance to the subject and adjust focus as necessary. At default settings, the shutter can be released whether or not the subject is in focus (release priority).
<b>AF-F</b> Full-time AF	The camera adjusts focus continuously in response to subject movement or changes in composition. When the shutter-release button is pressed halfway, the focus point will turn from red to green and focus will lock. This option is only available in movie mode.
<b>MF</b> Manual focus	Focus manually (□ 62). The shutter can be released whether or not the subject is in focus.

### Autofocus

The display may brighten or darken while the camera focuses and the focus point may sometimes be displayed in green when the camera is unable to focus. The camera may be unable to focus using autofocus in the following situations:

- The subject contains lines parallel to the long edge of the frame
- The subject lacks contrast
- The subject in the focus point contains areas of sharply contrasting brightness, or includes spot lighting or a neon sign or other light source that changes in brightness
- Flicker or banding appears under fluorescent, mercury-vapor, sodium-vapor, or similar lighting
- A cross (star) filter or other special filter is used
- The subject appears smaller than the focus point
- The subject is dominated by regular geometric patterns (e.g., blinds or a row of windows in a skyscraper)

### Turning the Camera Off

The focus position may change if you turn the camera off and then on again after focusing.

### Low-Light AF

For improved focus when lighting is poor, select **AF-S** and choose **On** for Custom Setting a11 (**Low-light AF**).



## AF-Area Mode

The focus point can be positioned using the sub-selector ( 92) or multi selector. AF-area mode controls how the camera selects the focus-point for autofocus.

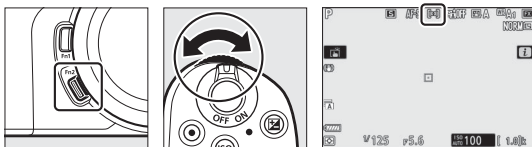

The default setting is **Single-point AF**, but other options can be selected using the **AF-area mode** items in the **i** menu and the photo and movie shooting menus ( 116, 133, 139).





At default settings, AF-area mode can also be selected by holding the **Fn2** button and rotating the sub-command dial ( 24).



Option	Description
 <b>Pinpoint AF</b>	Recommended for shots involving static subjects, such as buildings, in-studio product photography, or close-ups. Pinpoint AF is used for pinpoint focus on a selected spot in the frame. This option is only available when photo mode is selected and <b>Single AF</b> is chosen for <b>Focus mode</b> . Focusing may be slower than with single-point AF.
 <b>Single-point AF</b>	The camera focuses on a point selected by the user. Use with stationary subjects.



Option	Description
 <b>Dynamic-area AF</b>	<p>The camera focuses on a point selected by the user. If the subject briefly leaves the selected point, the camera will focus based on information from surrounding focus points. Use for photographs of athletes and other active subjects that are hard to frame using single-point AF. This option is only available when photo mode is selected and <b>Continuous AF</b> is chosen for <b>Focus mode</b>.</p>
 <b>Wide-area AF (S)</b>	<p>As for <b>Single-point AF</b>, except the camera focuses on a wider area, the focus areas for <b>Wide-area AF (L)</b> being larger than those for <b>Wide-area AF (S)</b>. Use for snapshots or photos of moving subjects that are hard to frame using single-point AF, or in movie mode for smooth focus during panning and tilting shots or when filming moving subjects. If the selected focus area contains subjects at different distances from the camera, the camera will assign priority to the closest subject.</p>
 <b>Wide-area AF (L)</b>	<p>As for <b>Single-point AF</b>, except the camera focuses on a wider area, the focus areas for <b>Wide-area AF (L)</b> being larger than those for <b>Wide-area AF (S)</b>. Use for snapshots or photos of moving subjects that are hard to frame using single-point AF, or in movie mode for smooth focus during panning and tilting shots or when filming moving subjects. If the selected focus area contains subjects at different distances from the camera, the camera will assign priority to the closest subject.</p>

Option	Description
 <b>Auto-area AF</b>	<p>The camera automatically detects the subject and selects the focus area. Use on occasions when you don't have time to select the focus point yourself, for portraits, or for snapshots and other spur-of-the-moment photos. The camera gives priority to portrait subjects; if a portrait subject is detected, an amber border indicating the focus point will appear around the subject's face or, if the camera detects the subject's eyes, one or the other of their eyes (face/eye-detection AF;  57). You can also configure the camera to detect the faces and eyes of dogs and cats by selecting <b>Animal detection</b> for Custom Setting a4 (<b>Auto-area AF face/eye detection</b>; for more information, see "Animal Face/Eye-Detection",  58). Face- and eye-detection free you to concentrate on composition and your subject's expression when photographing active human and animal portrait subjects. Subject tracking ( 59) can be activated by pressing the  button or by pressing a button to which subject-tracking AF has been assigned using Custom Setting f2 or g2 (<b>Custom control assignment</b>). Subject-tracking AF can be assigned to the <b>Fn1</b> and <b>Fn2</b> buttons on the camera or lens.</p>

 : **The Center Focus Point**

In all AF-area modes except **Auto-area AF**, a dot appears in the focus point when it is in the center of the frame.

 **Quick Focus-Point Selection**

For quicker focus-point selection, choose **Every other point** for Custom Setting a5 (**Focus points used**) to use only a quarter of the available focus points (the number of points available for **Wide-area AF (L)** does not change). If you prefer to use the sub-selector for focus-point selection, you can choose **Select center focus point** for Custom Setting f2 (**Custom control assignment**) > **Sub-selector center** to allow the center of the sub-selector to be used to quickly select the center focus point.

## ■ Face/Eye-Detection AF

When photographing portrait subjects with **Auto-area AF**, use Custom Setting a4 (**Auto-area AF face/eye detection**) to choose whether the camera detects both faces and eyes (face/eye-detection AF) or only faces (face-detection AF). If **Face and eye detection on** is selected and a portrait subject is detected, an amber border indicating the focus point will appear around the subject's face or, if the camera detects the subject's eyes, one or the other of their eyes (face/eye-detection AF). Faces detected when **Face detection on** is selected are similarly indicated by an amber focus point. If **AF-C** is selected for focus mode, the focus point will light amber when faces or eyes are detected, while if **AF-S** is selected, the focus point will turn green when the camera focuses.

If more than one portrait subject or more than one eye is detected, ◀ and ▶ icons will appear on the focus point, and you will be able to position the focus point over a different face or eye by pressing ◀ or ▶. If the subject looks away after their face is detected, the focus point will move to track their motion.

During playback, you can zoom in on the face or eye used for focus by pressing OK.

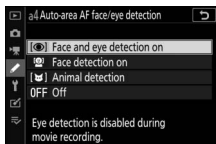

*Focus point*

### ☑ Face/Eye-Detection AF

Eye detection is not available in movie mode. Eye and face detection may not perform as expected if:

- the subject's face occupies a very large or very small proportion of the frame,
- the subject's face is lit too brightly or too poorly,
- the subject is wearing glasses or sunglasses,
- the subject's face or eyes are obscured by hair or other objects, or
- the subject moves excessively during shooting.

## ■ Animal Face/Eye-Detection AF

If **Animal detection** is selected for Custom Setting a4 (**Auto-area AF face/eye detection**) and the camera detects a dog or cat, an amber border indicating the focus point will appear around the subject's face or, if the camera detects the subject's eyes, one or the other of their eyes. If **AF-C** is selected for focus mode, the focus point will light amber when faces or eyes are detected, while if **AF-S** is selected, the focus point will turn green when the camera focuses.

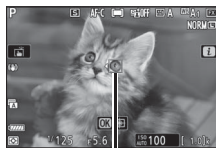
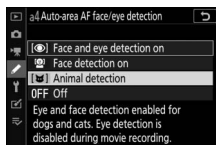

*Focus point*

If more than one animal or more than one eye is detected, ◀ and ▶ icons will appear on the focus point, and you will be able to position the focus point over a different face or eye by pressing ⌚ or ⌚.

During playback, you can zoom in on the face or eye used for focus by pressing Ⓞ.

### ■ Animal Detection AF

Animal eye-detection is not available in movie mode. Animal face- and eye-detection may fail to detect the faces or eyes of some breeds and may not perform as expected if:

- the subject's face occupies a very large or very small proportion of the frame,
- the subject's face is lit too brightly or too poorly,
- the subject's face or eyes are obscured by fur or other objects,
- the subject's eyes are similar in color to the rest of their face, or
- the subject moves excessively during shooting.

The light from the AF-assist illuminator may adversely affect the eyes of some animals; we recommend that you select **Off** for Custom Setting a12 (**Built-in AF-assist illuminator**).

## ■ ■ Subject Tracking

When **Auto-area AF** is selected for **AF-area mode**, pressing **OK** enables focus tracking. The focus point will change to a targeting reticle; position the reticle over the target and either press **OK** again or press the **AF-ON** button to start tracking.



The focus point will track the selected subject as it moves through the frame (in the case of portrait subjects, focus will track the subject's face). To tracking and select the center focus point, press **OK** a third time. To exit subject-tracking mode, press the **Q** (?) button.

If **AF-C** is selected for focus mode during still photography and tracking is started using the **AF-ON** button or by pressing the shutter-release button halfway, the camera will track the subject only while the control is pressed. Releasing the control restores the focus point selected before tracking started.

### ☑ Subject Tracking

The camera may be unable to track subjects if they move quickly, leave the frame or are obscured by other objects, change visibly in size, color, or brightness, or are too small, too large, too bright, too dark, or similar in color or brightness to the background.



## The Touch Shutter

Touch controls can be used to focus and release the shutter. Touch the display to focus and lift your finger to release the shutter.



Tap the icon shown in the illustration to choose the operation performed by tapping the display in shooting mode.

Choose from the following options:

-  **AF**: Touch the display to position the focus point and focus (if a face is detected, the camera will focus on the face closest to the selected point). Focus locks while your finger remains on the display; lift your finger to release the shutter. Available only in photo mode.
-  **AF**: As above, except that lifting your finger from the display does not release the shutter. If auto-area AF is selected for AF-area mode, the camera will track the selected subject as it moves through the frame; to switch to a different subject, tap it in the display.
-  **OFF**: Touch shutter disabled.

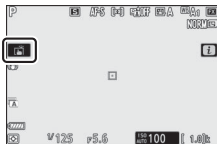

### Taking Pictures Using Touch Shooting Options

The shutter-release button can be used to focus and take pictures even when the  icon is displayed to show that touch shooting options are active. Touch shooting options can only be used to take pictures one at a time and cannot be used for manual focus or to take photographs during movie recording; for burst photography or to take photos during movie recording, use the shutter-release button.

In cases in which the camera has detected an eye using eye detection or animal eye-detection, the camera may fail to focus on the eye selected using touch controls, in which case it may be necessary to use the multi selector.

In self-timer mode, focus locks on the selected subject when you touch the monitor and the number of shots currently selected in self-timer mode will be taken starting about 10 seconds after you lift your finger from the display.

## Manual Focus

Manual focus can be used when autofocus does not produce the desired results. Position the focus point over your subject and rotate the focus or control ring until the subject is in focus.

For greater precision, press the  button to zoom in on the view through the lens.

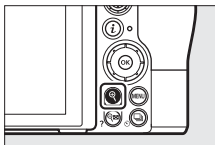
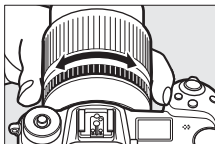

When the subject is in focus, the focus point will light green and the in-focus indicator (●) will appear in the display.

In-focus indicator	Description
●	Subject in focus.
▶	Focus point is between camera and subject.
◀	Focus point is behind subject.
▶ ◀ (flashes)	Camera unable to determine whether subject is in focus.

*Focus distance indicator*

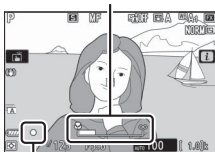

*In-focus indicator*

When using manual focus with subjects not suited to autofocus, note that the in-focus indicator (●) may be displayed when the subject is not in focus. Zoom in on the view through the lens and check focus. Use of a tripod is recommended when the camera is having trouble focusing.



### ✔ Lenses with Focus-Mode Selection

Manual focus can be selected using the controls on the lens.

### ✔ Focal Plane Position

To determine the distance between your subject and the camera, measure from the focal plane mark (⊕) on the camera body. The distance between the lens mounting flange and the focal plane is 16 mm (0.63 in.).

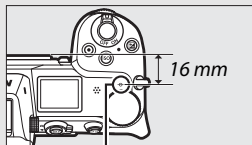

*Focal plane mark*

### ✔ Focus Peaking

If focus peaking is enabled using Custom Setting d10 (**Peaking highlights**), objects that are in focus will be indicated by colored outlines in manual focus mode. Note that peaking highlights may not be displayed if the camera is unable to detect outlines, in which case focus can be checked using the view through the lens in the display.

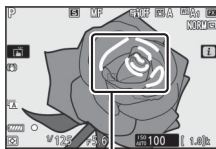

*Area in focus*

## White Balance

White balance ensures that white objects appear white, regardless of the color of the light source. The default setting (**WB A1**) is recommended with most light sources. If the desired results cannot be achieved with auto white balance, choose another option as described below.

White balance can be selected using the **White balance** items in the **i** menu and the photo and movie shooting menus (📖 101, 129, 136).

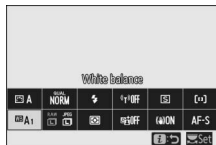



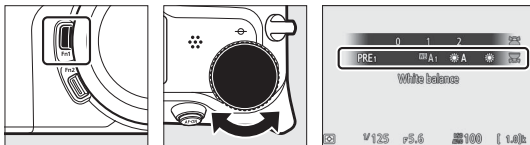



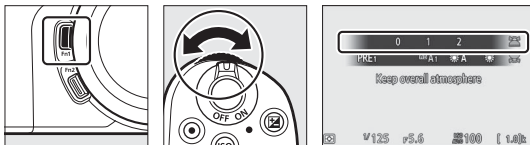

At default settings, white balance can also be selected by holding the **Fn1** button and rotating the main command dial (📖 24).





When **WB A (Auto)**, **☀ (Fluorescent)**, **📷 (Choose color temperature)**, or **PRE (Preset manual)** is selected, you can choose a sub-option by holding the **Fn1** button and rotating the sub-command dial.



Option	K*	Description
 <b>A Auto</b>		White balance is adjusted automatically for optimal results with most light sources. When an optional flash unit is used, white balance will be adjusted according to the lighting produced by the flash.
<b>Keep white (reduce warm colors)</b>	3500–8000	Eliminate warm color cast produced by incandescent lighting.
<b>Keep overall atmosphere</b>		Partially preserve warm color cast produced by incandescent lighting.
<b>Keep warm lighting colors</b>		Preserve warm color cast produced by incandescent lighting.
 <b>A Natural light auto</b>	4500–8000	When used under natural light, this option produces colors closer to those seen by the naked eye.
 <b>Direct sunlight</b>	5200	Use with subjects lit by direct sunlight.
 <b>Cloudy</b>	6000	Use in daylight under overcast skies.
 <b>Shade</b>	8000	Use in daylight with subjects in shade.
 <b>Incandescent</b>	3000	Use under incandescent lighting.
 <b>Fluorescent</b>		Use under fluorescent lighting; choose bulb type according to light source.
<b>Sodium-vapor lamps</b>	2700	
<b>Warm-white fluorescent</b>	3000	
<b>White fluorescent</b>	3700	
<b>Cool-white fluorescent</b>	4200	
<b>Day white fluorescent</b>	5000	
<b>Daylight fluorescent</b>	6500	
<b>High temp. mercury-vapor</b>	7200	
  <b>Flash</b>	5400	Use with studio strobe lighting and other large flash units.

\* Color temperature. All values are approximate and do not reflect fine-tuning (if applicable).

Option	K*	Description
 <b>Choose color temperature</b>	2500–10,000	Choose color temperature from list of values or by holding <b>Fn1</b> button and rotating sub-command dial.
<b>PRE Preset manual</b>	—	Measure white balance for subject or light source (press and hold <b>Fn1</b> button to enter direct measurement mode,  104), copy white balance from existing photograph, or choose existing value by holding <b>Fn1</b> button and rotating sub-command dial.

\* Color temperature. All values are approximate and do not reflect fine-tuning (if applicable).

### **WB A (“Auto”)**

The photo info for pictures shot using auto white balance lists the color temperature selected by the camera at the time the picture was taken. You can use this as reference when choosing a value for **Choose color temperature**. To view shooting data during playback, go to **Playback display options** in the playback menu and select **Shooting data**.

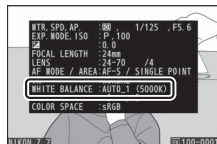

☑ **☀A ("Natural Light Auto")**

☀A (**Natural light auto**) may not produce the desired results under artificial light. Choose **WB A (Auto)** or an option that matches the light source.

☑ **Studio Flash Lighting**

**WB A (Auto)** may not produce the desired results with large studio flash units. Use preset white balance or set white balance to **WB ⚡ (Flash)** and use fine-tuning to adjust white balance.

☑ **White Balance Fine-Tuning**

At settings other than **Choose color temperature**, white balance can be fine-tuned using the **White balance** items in the **i** menu and the photo and movie shooting menus (☐ 102).

🔍 **Color Temperature**

The perceived color of a light source varies with the viewer and other conditions. Color temperature is an objective measure of the color of a light source, defined with reference to the temperature to which an object would have to be heated to radiate light in the same wavelengths. While light sources with a color temperature in the neighborhood of 5000–5500 K appear white, light sources with a lower color temperature, such as incandescent light bulbs, appear slightly yellow or red. Light sources with a higher color temperature appear tinged with blue.

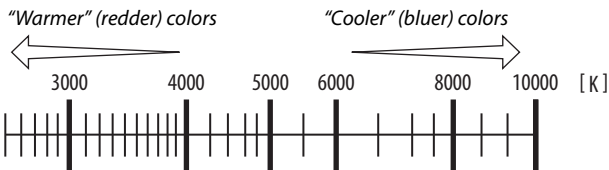

In general, choose lower values if your pictures have a red cast or to intentionally make colors colder, higher values if your pictures are tinged blue or to intentionally make colors warmer.

## Silent Photography

To enable the electronic shutter and eliminate the noise and vibration caused by operation of the mechanical shutter, select **On** for **Silent photography** in the photo shooting menu. Regardless of the setting chosen for **Beep options** in the setup menu, no beep will sound when the camera focuses or while the self-timer is counting down. Note that the electronic shutter will be used regardless of the option selected for Custom Setting d5 (**Shutter type**).

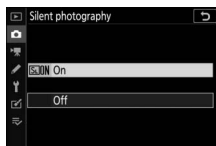

An icon is displayed while silent photography is in effect. In release modes other than **Continuous H (extended)**, the display will briefly go dark when the shutter is released to signal that a photo has been taken.



Enabling silent photography changes the frame advance rates for continuous release modes (88) and disables some features, including the flash, long exposure noise reduction, and flicker reduction.

### **Silent Photography**

Selecting **On** for **Silent photography** mutes the shutter, but this does not absolve photographers of the need to respect their subjects' privacy and image rights. Although the noise of the mechanical shutter is muted, other sounds may still be audible, for example during autofocus or aperture adjustment or if the **MENU** or  button is pressed when an option other than **Off** is selected for **Vibration reduction**.

During silent photography, flicker, banding, or distortion may be visible in the display and in the final picture under fluorescent, mercury vapor, or sodium lamps or if the camera or subject moves during shooting. Jagged edges, color fringing, *moiré*, and bright spots may also appear. Bright regions or bands may appear in some areas of the frame with flashing signs and other intermittent light sources or if the subject is briefly illuminated by a strobe or other bright, momentary light source.

## Rating Pictures

Selected pictures can be rated or marked as candidates for later deletion. Ratings can also be viewed in Capture NX-D and ViewNX-i. Protected pictures cannot be rated.

### 1 Select an image.

Press the  button to start playback and display a picture you want to rate.

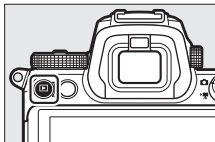

### 2 Display the *i* menu.

Press the *i* button to view the *i* menu.

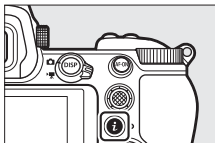

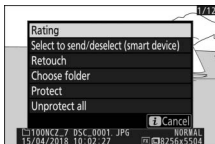

### 3 Select Rating.

Highlight **Rating** and press .



### 4 Choose a rating.

Rotate the main command dial to choose a rating of from zero to five stars, or select  to mark the picture as a candidate for later deletion. Press  to complete the operation.





## Protecting Pictures from Deletion

Use the **Protect** option in the **i** menu to protect pictures from accidental deletion. Note that this does NOT prevent pictures being deleted when the memory card is formatted.

### 1 Select an image.

Press the  button to start playback and display a picture you want to protect.

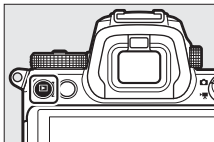

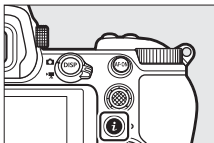

### 2 Display the **i** menu.

Press the **i** button to view the **i** menu.



### 3 Select **Protect**.

Highlight **Protect** and press .  
Protected pictures are indicated by a  icon; to remove protection, display the picture and repeat Steps 2–3.



#### Removing Protection from All Pictures

To remove protection from all pictures in the folder or folders currently selected for **Playback folder** in the playback menu, select **Unprotect all** in the **i** menu.

# Shooting Controls

This chapter describes controls that can be used during shooting.

## The Mode Dial

Press the mode dial lock release and rotate the mode dial to choose from the following modes:

- **<sup>AUTO</sup> Auto:** A “point-and-shoot” mode in which the camera sets exposure and hue (📖 41, 45).
- **P Programmed auto:** The camera sets shutter speed and aperture for optimal exposure. Recommended for snapshots and in other situations in which there is little time to adjust camera settings.
- **S Shutter-priority auto:** You choose the shutter speed; the camera selects the aperture for best results. Use to freeze or blur motion.
- **A Aperture-priority auto:** You choose the aperture; the camera selects the shutter speed for best results. Use to blur backgrounds or bring both foreground and background into focus.
- **M Manual:** You control both shutter speed and aperture. Set shutter speed to “bulb” or “time” for long time-exposures.
- **U1, U2, U3 User settings modes:** Assign frequently-used settings to these positions for quick recall.

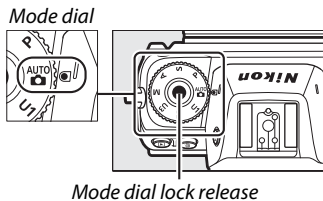

## **P: Programmed Auto**

In this mode, the camera automatically adjusts shutter speed and aperture according to a built-in program to ensure optimal exposure in most situations. Different combinations of shutter speed and aperture that

produce the same exposure can be selected by rotating the main command dial (“flexible program”). While flexible program is in effect, a flexible program indicator (\*) is displayed. To restore default shutter speed and aperture settings, rotate the main command dial until the indicator is no longer displayed, choose another mode, or turn the camera off.



## **S: Shutter-Priority Auto**

In shutter-priority auto, you choose the shutter speed while the camera automatically selects the aperture that will produce the optimal exposure. To choose a shutter speed, rotate the main command dial. Shutter speed can be set to “x200” or to values between 30 s and  $\frac{1}{8000}$  s and can be locked at the selected setting (148).



*Monitor*



*Control panel*

## A: Aperture-Priority Auto

In aperture-priority auto, you choose the aperture while the camera automatically selects the shutter speed that will produce the optimal exposure. To choose an aperture between the minimum and maximum values for the lens, rotate the sub-command dial.

Aperture can be locked at the selected setting (📖 148).



Monitor

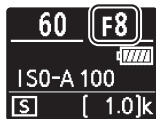

Control panel

### 📌 Movie Mode Exposure Settings

The following exposure settings can be adjusted in movie mode:

	Aperture	Shutter speed	ISO sensitivity
P, S <sup>1</sup>	—	—	— <sup>2,3</sup>
A	✓	—	— <sup>2,3</sup>
M	✓	✓	✓ <sup>3,4</sup>

- 1 Exposure for mode **S** is equivalent to mode **P**.
- 2 The upper limit for ISO sensitivity can be selected using the **ISO sensitivity settings > Maximum sensitivity** option in the movie shooting menu.
- 3 Regardless of the option chosen for **ISO sensitivity settings > Maximum sensitivity** or for **ISO sensitivity (mode M)**, the upper limit when **On** is selected for **Electronic VR** in the movie shooting menu is ISO 25600 (Z 7) or 51200 (Z 6).
- 4 If **On** is selected for **ISO sensitivity settings > Auto ISO control (mode M)** in the movie shooting menu, the upper limit for ISO sensitivity can be selected using the **Maximum sensitivity** option.

## **M: Manual**

In manual exposure mode, you control both shutter speed and aperture. Rotate the main command dial to choose a shutter speed, and the sub-command dial to set aperture. Shutter speed can be set to “×200” or to values between 30 s and  $\frac{1}{8000}$  s, or the shutter can be held open indefinitely for a long time-exposure (80). Aperture can be set to values between the minimum and maximum values for the lens. Use the exposure indicators to check exposure.

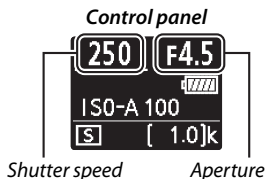
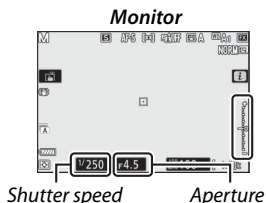

Shutter speed and aperture can be locked at the selected settings.

## ✔ Exposure Indicators

The exposure indicators show whether the photograph would be under- or over-exposed at current settings. Depending on the option chosen for Custom Setting b1 (**EV steps for exposure cntrl**), the amount of under- or overexposure is shown in increments of  $\frac{1}{3}$  or  $\frac{1}{2}$  EV. If the limits of the exposure metering system are exceeded, the displays will flash.

	Custom Setting b1 set to "1/3 step"		
	Optimal exposure	Underexposed by $\frac{1}{3}$ EV	Overexposed by over 3 EV
Monitor			
Viewfinder			

## ✔ Auto ISO Sensitivity Control (Mode M)

If auto ISO sensitivity control (☐ 84) is enabled, ISO sensitivity will automatically be adjusted for optimal exposure at the selected shutter speed and aperture.

## User Settings: U1, U2, and U3 Modes

Assign frequently-used settings to the **U1**, **U2**, and **U3** positions on the mode dial.

### ■ **Saving User Settings**

Follow the steps below to save settings:

#### **1** Select a mode.

Rotate the mode dial to the desired mode.

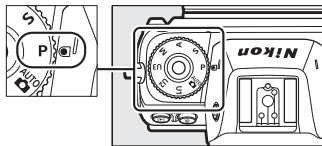

#### **2** Adjust settings.

Make the desired adjustments to camera settings, including:

- photo shooting menu options,
- movie shooting menu options,
- Custom Settings, and
- shooting mode, shutter speed (modes **S** and **M**), aperture (modes **A** and **M**), flexible program (mode **P**), exposure compensation, and flash compensation.

#### **3** Select **Save user settings**.

Highlight **Save user settings** in the setup menu and press .

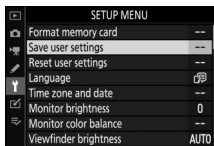

#### **4** Select a position.

Highlight **Save to U1**, **Save to U2**, or **Save to U3** and press .

---

## 5 Save user settings.

Highlight **Save settings** and press **OK** to assign the settings selected in Steps 1 and 2 to the mode dial position selected in Step 4.

### ■ Recalling User Settings

Rotating the mode dial to **U1**, **U2**, or **U3** recalls the settings last saved to that position.

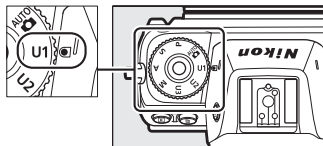

### ■ Resetting User Settings

To reset settings for **U1**, **U2**, or **U3** to default values:

---

## 1 Select Reset user settings.

Highlight **Reset user settings** in the setup menu and press **OK**.

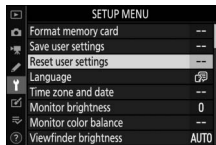

---

## 2 Select a position.

Highlight **Reset U1**, **Reset U2**, or **Reset U3** and press **OK**.

---

## 3 Reset user settings.

Highlight **Reset** and press **OK** to restore default settings for the selected position. The camera will function in mode **P**.



## User Settings

The following cannot be saved to **U1**, **U2**, or **U3**.

### **Photo shooting menu:**

- Storage folder
- Choose image area
- Manage Picture Control
- Multiple exposure
- Interval timer shooting
- Time-lapse movie
- Focus shift shooting

### **Movie shooting menu:**

- Choose image area
- Manage Picture Control

## **Long Time-Exposures (Mode M)**

Select the following shutter speeds for long time-exposures of moving lights, the stars, night scenery, or fireworks.

- **Bulb:** The shutter remains open while the shutter-release button is held down.
- **Time:** The exposure starts when the shutter-release button is pressed and ends when the button is pressed a second time.



- **Shutter speed:** Bulb (35-second exposure)
- **Aperture:** f/25

To prevent blur, mount the camera on a tripod or use an optional wireless remote controller, remote cord, or other remote release device. Nikon also recommends using a fully-charged battery or an optional AC adapter and power connector to prevent loss of power while the shutter is open. Note that noise (bright spots, randomly-spaced bright pixels, or fog) may be present in long exposures. Bright spots and fog can be reduced by choosing **On** for **Long exposure NR** in the photo shooting menu.

### **1 Ready the camera.**

Mount the camera on a tripod or place it on a stable, level surface.

### **2 Select mode M.**

Rotate the mode dial to **M**.

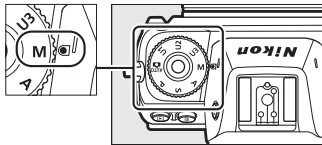

---

### 3 Choose a shutter speed.

Rotate the main command dial to choose a shutter speed of **Bulb** or **Time**.

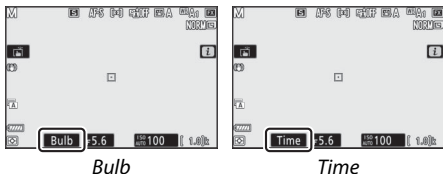

---

### 4 Open the shutter.

**Bulb:** After focusing, press the shutter-release button all the way down. Keep the shutter-release button pressed until the exposure is complete.

**Time:** Press the shutter-release button all the way down.

---

### 5 Close the shutter.

**Bulb:** Take your finger off the shutter-release button.

**Time:** Press the shutter-release button all the way down.

## The ISO (ISO Sensitivity) Button

Hold the **ISO** button and rotate the main command dial to adjust the camera's sensitivity to light according to the amount of light available. The current setting is shown in the shooting display and control panel. Choose from settings of from ISO 64 to ISO 25600 (or in the case of the Z 6, of from ISO 100 to ISO 51200); settings of from about 0.3 to 1 EV below the lowest of these values and 0.3 to 2 EV above the highest are also available for special situations. **AUTO** mode offers an additional **ISO-A** (auto) option.

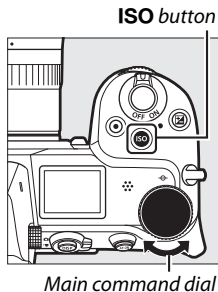

### ✓ ISO Sensitivity

The higher the ISO sensitivity, the less light needed to make an exposure, allowing faster shutter speeds or smaller apertures, but the more likely the image is to be affected by noise (randomly-spaced bright pixels, fog, or lines). Noise is particularly likely at settings between **Hi 0.3** and **Hi 2**.

### ✓ Hi 0.3–Hi 2

**Hi 0.3** through **Hi 2** correspond to ISO sensitivities 0.3–2 EV over the highest numerical value. **Hi 0.3** is equivalent to ISO 32000 (Z 7) or 64000 (Z 6), **Hi 2** to ISO 102400 (Z 7) or 204800 (Z 6).

**☑ Lo 0.3–Lo 1**

**Lo 0.3** through **Lo 1** correspond to ISO sensitivities 0.3–1 EV below the lowest numerical value. **Lo 0.3** is equivalent to ISO 50 (Z 7) or 80 (Z 6), **Lo 1** to ISO 32 (Z 7) or 50 (Z 6). Use for larger apertures or slow shutter speeds when lighting is bright. Highlights may lose some detail; in most cases, ISO sensitivities at or above the lowest numerical value are recommended.



## The (Exposure Compensation) Button

In modes other than **AUTO**, exposure compensation can be used to alter exposure from the value suggested by the camera, making pictures brighter or darker. Choose from values between  $-5$  EV (underexposure) and  $+5$  EV (overexposure) in increments of  $\frac{1}{3}$  EV (photographs only; the range for movies is  $-3$  to  $+3$  EV). In general, positive values make the subject brighter while negative values make it darker.



$-1$  EV







No exposure  
compensation

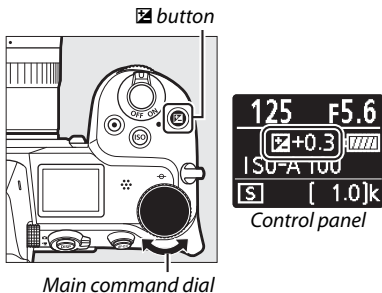

$+1$  EV

To choose a value for exposure compensation, press the  button and rotate the main command dial until the desired value is displayed.



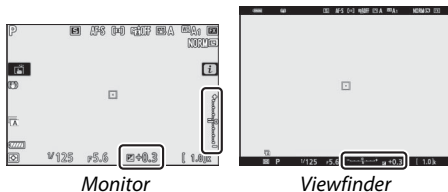

At values other than  $\pm 0.0$ , the camera displays a  icon (movie mode) or a  icon and the exposure indicator (photo mode) after you release the  button. The current value for exposure compensation can be confirmed by pressing the  button.



Normal exposure can be restored by setting exposure compensation to  $\pm 0$ . Exposure compensation is not reset when the camera is turned off.

#### Mode M



In mode **M**, exposure compensation affects only the exposure indicator; shutter speed and aperture do not change (ISO sensitivity will, however, automatically be adjusted according to the exposure compensation value selected when auto ISO sensitivity control is enabled;  84). The exposure indicator and the current value for exposure compensation can be displayed by pressing the  button.

#### Flash Photography

When an optional flash unit is used, exposure compensation affects both flash level and exposure, altering the brightness of both the main subject and the background. Custom Setting e3 (**Exposure comp. for flash**) can be used to restrict the effects of exposure compensation to the background only.



## The /☺ (Release Mode/Self-Timer) Button

The “release mode” determines what happens when the shutter-release button is pressed. To choose a release mode, hold the  (☺) button and rotate the main command dial. Press  when the desired option is highlighted; the selected option is indicated by icons in the shooting display and control panel.

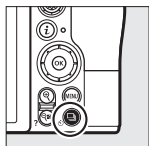



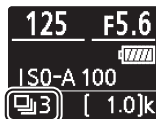

Monitor



Control panel

The following options are available in photo mode.

Option	Description
 <b>Single frame</b>	The camera takes one photograph each time the shutter-release button is pressed.
 <b>Continuous L</b>	While the shutter-release button is held down, the camera records 1–5 frames per second. The frame rate can be chosen by rotating the sub-command dial when <b>Continuous L</b> is highlighted in the release-mode menu.
 <b>Continuous H</b>	While the shutter-release button is held down, the camera records up to about 5.5 frames per second.

Option	Description
 <b>Continuous H (extended)</b>	While the shutter-release button is held down, the camera records up to about 9 frames per second (Z 7) or 12 frames per second (Z 6). Optional flash units cannot be used. Flicker reduction has no effect.
 <b>Self-timer</b>	Take pictures with the self-timer (☐ 90).

### The Shooting Display

In continuous low-speed and continuous high-speed modes, the display is updated in real time even while shooting is in progress.

### Frame Advance Rate

Frame advance rate varies with camera settings. The approximate maximum rates at different settings are given in the table below.

Release mode	Image quality	Bit depth	Silent photography	
			Off	On
<b>Continuous L</b>	JPEG/TIFF	—	5 fps	Z 7: 4 fps
	NEF (RAW)/ NEF (RAW) + JPEG	12		Z 6: 4.5 fps
		14		Z 7: 3.5 fps Z 6: 4 fps
<b>Continuous H</b>	JPEG/TIFF	—	5.5 fps	Z 7: 4 fps
	NEF (RAW)/ NEF (RAW) + JPEG	12		Z 6: 4.5 fps
		14	Z 7: 5 fps Z 6: 5.5 fps	Z 7: 3.5 fps Z 6: 4 fps
<b>Continuous H (extended)</b>	JPEG/TIFF	—	Z 7: 9 fps	Z 7: 8 fps
	NEF (RAW)/ NEF (RAW) + JPEG	12	Z 6: 12 fps	Z 6: 12 fps
		14	Z 7: 8 fps Z 6: 9 fps	Z 7: 6.5 fps Z 6: 8 fps

### ✔ Continuous H (Extended)

Depending on camera settings, exposure may vary erratically during each burst. This can be prevented by locking exposure (☞ 93).

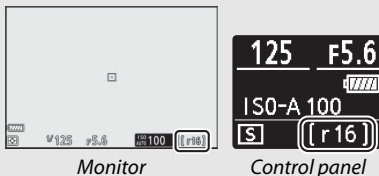

### ✔ The Memory Buffer

The camera is equipped with a memory buffer for temporary storage, allowing shooting to continue while photographs are being saved to the memory card. The approximate number of images that can be stored in the buffer at current settings is shown in the exposure-count displays while the shutter-release button is pressed halfway.



While photographs are being recorded to the memory card, the memory card access lamp will light. Depending on shooting conditions and memory card performance, recording may take from a few seconds to a few minutes. *Do not remove the memory card or remove or disconnect the power source until the access lamp has gone out.* If the camera is switched off while data remain in the buffer, the power will not turn off until all images in the buffer have been recorded. If the battery is exhausted while images remain in the buffer, the shutter release will be disabled and the images transferred to the memory card.



In movie mode, you can choose the operation performed when the shutter-release button is pressed (☞ 45).

Option	Description
 <b>Single frame</b>	The camera takes one photograph each time the shutter-release button is pressed. Regardless of the option selected, a maximum of 50 photos can be taken with each movie.
 <b>Continuous</b>	The camera takes photographs for up to 3 (Z 7) or 2 (Z 6) seconds at a time while the shutter-release button is held down. The frame rate varies with the option selected for <b>Frame size/frame rate</b> in the movie shooting menu. Only one photograph can be taken at a time while movie recording is in progress.

## The Self-Timer

In self-timer mode, pressing the shutter-release button starts a timer, and a photo is taken when the timer expires.

### 1 Select self-timer mode.

Keeping the  button pressed, rotate the main command dial to highlight  (self-timer).



### 2 Choose the shutter-release delay.

Rotate the sub-command dial to select the shutter-release delay and press .



---

### 3 Frame the photograph and focus.

If **AF-S** is selected for focus mode, the timer will not start unless the camera is able to focus.



---

### 4 Start the timer.

Press the shutter-release button all the way down to start the timer. A  icon will appear in the display and the self-timer lamp will start to flash, stopping two seconds before the photograph is taken.



#### Taking Multiple Shots

Use Custom Setting c2 (**Self-timer**) to choose the number of shots taken, and the interval between the shots taken, when the self-timer finishes counting down.

## The Sub-Selector

Use the sub-selector as a joystick to select the focus point, or press the center to lock focus and/or exposure.

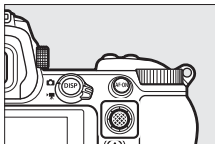

### Focus-Point Selection

Use the sub-selector to select the focus point in the shooting display. Focus-point selection is not available when auto-area AF is selected for AF-area mode (📖 54).

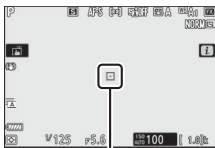

*Focus point*

### Autoexposure (AE) Lock

Pressing the center of the sub-selector locks exposure at the current setting. AE lock can be used to recompose shots after metering a subject that will not be in the selected focus area in the final composition, and is particularly effective with spot or center-weighted metering.

### Focus Lock

Press the center of the sub-selector to lock focus on the current subject when **AF-C** is selected for focus mode. When using focus lock, choose an AF-area mode other than auto-area AF.

## ■ ■ Locking Focus and Exposure

Follow the steps below to use focus and exposure lock.

### 1 Set focus and exposure.

Position the subject in the selected focus point and press the shutter-release button halfway to set focus and exposure.

### 2 Lock focus and exposure.

With the shutter-release button pressed halfway, press the center of the sub-selector to lock both focus and exposure (an **AE-L** icon will be displayed).

Shutter-release button



Sub-selector



### 3 Recompose the photograph and shoot.

Focus will remain locked between shots if you keep the shutter-release button pressed halfway (**AF-S**) or keep the center of the sub-selector pressed, allowing several photographs in succession to be taken at the same focus setting.

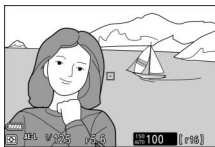

Do not change the distance between the camera and the subject while focus lock is in effect. If the subject moves, focus again at the new distance.

#### **AF-S**

When **AF-S** is selected for focus mode, focus will lock while the shutter-release button is pressed halfway (focus will also lock while the center of the sub-selector is pressed).

#### **Using the Shutter-Release Button for Exposure Lock**

If **On (half press)** is selected for Custom Setting c1 (**Shutter-release button AE-L**), exposure will lock while the shutter-release button is pressed halfway.



# The *i* Menu

Pressing the *i* button displays the *i* menu: a menu of frequently-used settings for the current mode.

## Using the *i* Menu

Press the *i* button to display the *i* menu.

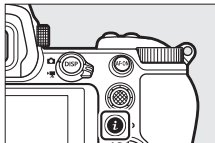

Highlight items using the multi selector and press **OK** to view options, then highlight an option and press **OK** to select it and return to the *i* menu (to exit to the previous display without changing settings, press the *i* button).

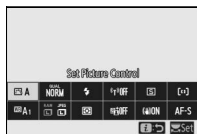

### The Command Dials

You can also adjust settings for highlighted items by rotating the main command dial to choose an option and then pressing **OK** (sub-options, if available, can be selected by rotating the sub-command dial; in some cases, the same options can be selected using either dial). The current option will also be selected if you highlight another item with the multi selector or press the shutter-release button halfway.



## The Photo-Mode *i* Menu



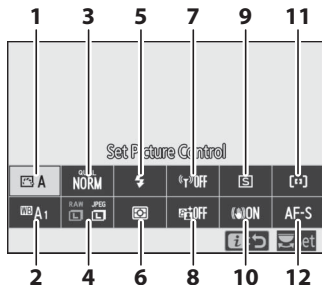







At default settings, the following items appear in the *i* menu for photo mode.





<b>1</b> Set Picture Control .....	97	<b>7</b> Wi-Fi connection .....	112
<b>2</b> White balance .....	101	<b>8</b> Active D-Lighting .....	113
<b>3</b> Image quality .....	107	<b>9</b> Release mode.....	114
<b>4</b> Image size.....	109	<b>10</b> Vibration reduction.....	115
<b>5</b> Flash mode.....	110	<b>11</b> AF-area mode.....	116
<b>6</b> Metering .....	111	<b>12</b> Focus mode .....	116

## Set Picture Control

Choose a Picture Control according to the subject or type of scene.

Option	Description
 <b>A Auto</b>	The camera automatically adjusts hues and tones based on the <b>Standard</b> Picture Control. The complexions of portrait subjects will appear softer, and such elements as the foliage and sky in outdoor shots more vivid, than in pictures taken with the <b>Standard</b> Picture Control.
 <b>SD Standard</b>	Standard processing for balanced results. Recommended for most situations.
 <b>NL Neutral</b>	Minimal processing for natural results. Choose for photographs that will later be processed or retouched.
 <b>VI Vivid</b>	Pictures are enhanced for a vivid, photoprint effect. Choose for photographs that emphasize primary colors.
 <b>MC Monochrome</b>	Take monochrome photographs.
 <b>PT Portrait</b>	Process portraits for skin with natural texture and a rounded feel.
 <b>LS Landscape</b>	Produces vibrant landscapes and cityscapes.
 <b>FL Flat</b>	Details are preserved over a wide tone range, from highlights to shadows. Choose for photographs that will later be extensively processed or retouched.
 <b>01– Creative Picture Control</b>  <b>20 Control</b>	Choose from the following Picture Controls, each a unique combination of hue, tone, saturation, and other settings tuned for a particular effect: <b>Dream, Morning, Pop, Sunday, Somber, Dramatic, Silence, Bleached, Melancholic, Pure, Denim, Toy, Sepia, Blue, Red, Pink, Charcoal, Graphite, Binary, and Carbon.</b>

To view Picture Control settings, highlight a Picture Control and press . Changes to settings can be previewed in the display ( 99).



The current Picture Control is indicated by an icon in the display during shooting.



## ■ ■ Modifying Picture Controls

Picture Controls can be modified to suit the scene or the photographer's creative intent. Highlight **Set Picture Control** in the **i** menu and press **OK** to display the Picture Control list, then highlight a Picture Control and press **Down** to display Picture Control settings. Press **Up** or **Down** to highlight the desired setting and press **Left** or **Right** to choose a value in increments of 1, or rotate the sub-command dial to choose a value in increments of 0.25 (the options available vary with the Picture Control selected). Default settings can be restored by pressing the **Reset** button.

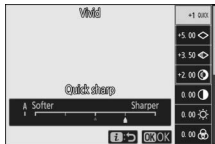

After adjusting settings to your satisfaction, press **OK** to put the changes into effect and return to the **i** menu. Picture Controls that have been modified from default settings are indicated by an asterisk ("**\***").



### ☑ Previous Settings

The **Δ** indicator under the value display in the Picture Control setting menu indicates the previous value for the setting.



### ☑ "A" (Auto)

Selecting the **A** (auto) option available for some settings lets the camera adjust the setting automatically. Results vary with exposure and the position of the subject in the frame.

### ☑ The "A Auto" Picture Control

If **A Auto** is selected for Set Picture Control, settings can be adjusted in the range **A-2** to **A+2**.



The following settings are available:

Option	Description
<b>Effect level</b>	Mute or heighten the effect of Creative Picture Control.
<b>Quick sharp</b>	Quickly adjust levels for balanced <b>Sharpening</b> , <b>Mid-range sharpening</b> , and <b>Clarity</b> . You can also make individual adjustments to the following parameters:
<b>Sharpening</b>	<ul style="list-style-type: none"> <li>• <b>Sharpening</b>: Control the sharpness of details and outlines.</li> </ul>
<b>Mid-range sharpening</b>	<ul style="list-style-type: none"> <li>• <b>Mid-range sharpening</b>: Adjust sharpness according to the fineness of the patterns and lines in mid-tones affected by <b>Sharpening</b> and <b>Clarity</b>.</li> </ul>
<b>Clarity</b>	<ul style="list-style-type: none"> <li>• <b>Clarity</b>: Adjust overall sharpness and the sharpness of thicker outlines without affecting brightness or dynamic range.</li> </ul>
<b>Contrast</b>	Adjust contrast.
<b>Brightness</b>	Raise or lower brightness without loss of detail in highlights or shadows.
<b>Saturation</b>	Control the vividness of colors.
<b>Hue</b>	Adjust hue.
<b>Filter effects</b>	Simulate the effect of color filters on monochrome pictures.
<b>Toning</b>	Choose the tint used in monochrome pictures. Pressing  when an option other than <b>B&amp;W</b> (black-and-white) is selected displays saturation options.
<b>Toning</b> (Creative Picture Control)	Adjust the shade of color used for Creative Picture Controls.









#### Filter Effects

Choose from the following:

Mode	Setting
<b>Y</b> (yellow)	These options enhance contrast and can be used to tone down the brightness of the sky in landscape photographs. Orange produces more contrast than yellow, red more contrast than orange.
<b>O</b> (orange)	
<b>R</b> (red)	
<b>G</b> (green)	Green softens skin tones and can be used for portraits.

## White Balance

Adjust white balance (for more information, see “White Balance,” p. 64).

Option	Option
<b>WB A</b> Auto	 <b>Fluorescent</b>
Keep white (reduce warm colors)	Sodium-vapor lamps
Keep overall atmosphere	Warm-white fluorescent
Keep warm lighting colors	White fluorescent
 <b>A</b> Natural light auto	Cool-white fluorescent
 Direct sunlight	Day white fluorescent
 Cloudy	Daylight fluorescent
 Shade	High temp. mercury-vapor
 Incandescent	<b>WB</b>  Flash
	 Choose color temperature
	<b>PRE</b> Preset manual

Pressing  when **Auto** or **Fluorescent** is highlighted displays sub-options for the highlighted item.





The current white balance option is indicated by an icon in the display during shooting.

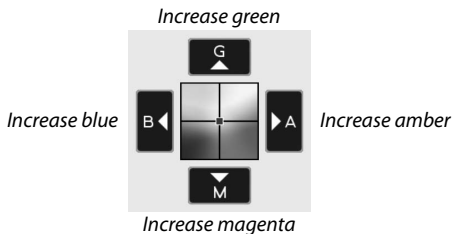
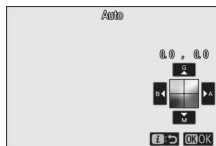

## ■ Fine-Tuning White Balance

Selecting **White balance** in the **i** menu displays a list of white balance options. If an option other than **Choose color temperature** is highlighted, fine-tuning options can be displayed by pressing . Any changes to fine-tuning options can be previewed in the display.



Tap the arrows in the display or use the multi selector to fine-tune white balance. Press  to save settings and return to the **i** menu.

An asterisk ("**\***") next to the white balance icon in the shooting display indicates that fine-tuning is in effect.





## ■ Choosing a Color Temperature





Selecting **White balance** in the **i** menu displays a list of white balance options. When **Choose color temperature** is highlighted, color temperature options can be viewed by pressing .



Value for  
Amber-Blue axis



Value for  
Green-Magenta axis

Press  or  to highlight digits on the **Amber-Blue** or **Green-Magenta** axis and press  or  to change. Press  to save settings and return to the **i** menu. If a value other than zero is selected for the **Green-Magenta** axis, an asterisk (“\*”) will be displayed next to the white balance icon.

### ☑ Choose Color Temperature

Note that the desired results will not be obtained with fluorescent lighting. Choose  (**Fluorescent**) for fluorescent light sources. With other light sources, take a test shot to determine if the selected value is appropriate.

## ■ Preset Manual

Preset manual is used to record and recall up to six custom white balance settings for shooting under mixed lighting or to compensate for light sources with a strong color cast. Follow the steps below to measure a value for preset manual white balance.

- 1 Display white balance presets.**  
Highlight **Preset manual** in the **i** menu white balance display and press **↶** to display a list of white balance presets.



- 2 Select a preset.**  
Highlight the desired white balance preset (d-1 to d-6) and press **OK** to select the highlighted preset and return to the **i** menu.

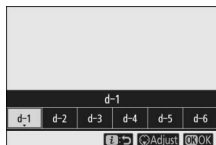

### ☑ Protected Presets

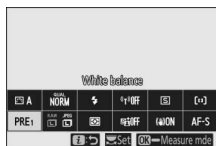

Presets indicated by a **🔒** icon are protected and cannot be changed.

- 3 Select direct measurement mode.**  
Highlight **White balance** in the **i** menu and press and hold **OK** until the **PRE** icons in the shooting display and control panel start to flash and white balance target (**□**) is displayed at the selected focus point.



---

## 4 Measure white balance.

To measure white balance, tap a white or gray object, or use the multi-selector to position the  over a white or gray area of the display and either press  or press the shutter-release button all the way down (note that the  cannot be repositioned when an optional flash unit is attached, in which case you will need to measure white balance with a white or gray object positioned in the center of the frame).



If the camera is unable to measure white balance, a message will be displayed. Try measuring white balance again with a different target.



---

## 5 Exit direct measurement mode.

Press the  button to exit direct measurement mode.

### ✔ Measuring Preset Manual White Balance

Preset manual white balance cannot be measured while HDR or multiple exposure shooting is in progress.

### ✔ Direct Measurement Mode

Direct measurement mode will end if no operations are performed in the time selected for Custom Setting c3 (**Power off delay**) > **Standby timer**.

### ✔ Managing Presets

The **White balance** > **Preset manual** option in the photo shooting menu can be used to copy white balance from an existing photograph to a selected preset, add comments, or protect presets.

### ✔ Preset Manual: Selecting a Preset

To choose a preset, select **White balance** > **Preset manual** in the photo shooting menu, then highlight a preset and press **OK**. If no value currently exists for the selected preset, white balance will be set to 5200 K, the same as **Direct sunlight**.



## Image Quality

Choose a file format for photographs.

Option	Description
NEF (RAW) + JPEG fine★	Record two copies of each photo: an NEF (RAW) image and a JPEG copy. Only the JPEG copy is displayed during playback, but deleting the JPEG copy also deletes the NEF (RAW) image. The NEF (RAW) image can only be viewed using a computer.
NEF (RAW) + JPEG fine	
NEF (RAW) + JPEG normal★	
NEF (RAW) + JPEG normal	
NEF (RAW) + JPEG basic★	
NEF (RAW) + JPEG basic	
NEF (RAW)	Record photos in NEF (RAW) format.
JPEG fine★	Record photos in JPEG format. Compression increases and file size decreases as quality progresses from “fine” through “normal” to “basic”. Choose options with ★ to maximize quality, options without ★ to ensure that all images have more or less the same file size.
JPEG fine	
JPEG normal★	
JPEG normal	
JPEG basic★	
JPEG basic	
TIFF (RGB)	Record photos in uncompressed TIFF-RGB format at a bit depth of 8 bits per channel (24-bit color).

The option currently selected is shown in the display during shooting.



### **NEF (RAW)**

NEF (RAW) image files (extension “\*.nef”) contain the raw data output from the image sensor. Using Nikon’s ViewNX-i or Capture NX-D software, you can adjust and re-adjust settings such as exposure compensation and white balance as often as you please without degrading image quality, making this format ideal for photos that will be processed in multiple different ways. ViewNX-i and Capture NX-D are available free-of-charge from the Nikon Download Center.

The process of converting NEF (RAW) images to other formats such as JPEG is referred to as “NEF (RAW) processing”. You can save NEF (RAW) images in other formats using the ViewNX-i and Capture NX-D computer applications or the **NEF (RAW) processing** option in the camera retouch menu.

## Image Size

Choose the size at which photographs are recorded.

Option		Description
NEF (RAW)	Large	Choose the size for photos recorded in NEF (RAW) format. <b>NEF (RAW)</b> is available only when an NEF (RAW) option is selected for image quality.
	Medium	
	Small	
JPEG/TIFF	Large	Choose the size for photos recorded in JPEG or TIFF format.
	Medium	
	Small	

The option currently selected is shown in the display during shooting.

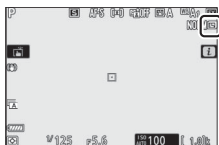

The physical dimensions of the photos in pixels varies with the option selected for **Choose image area**.

Z7:







		Image size		
		Large	Medium	Small
Image area	FX (36 × 24)	8256 × 5504	6192 × 4128	4128 × 2752
	DX (24 × 16)	5408 × 3600	4048 × 2696	2704 × 1800
	5 : 4 (30 × 24)	6880 × 5504	5152 × 4120	3440 × 2752
	1 : 1 (24 × 24)	5504 × 5504	4128 × 4128	2752 × 2752
	16 : 9 (36 × 20)	8256 × 4640	6192 × 3480	4128 × 2320

Z6:

		Image size		
		Large	Medium	Small
Image area	FX (36 × 24)	6048 × 4024	4528 × 3016	3024 × 2016
	DX (24 × 16)	3936 × 2624	2944 × 1968	1968 × 1312
	1 : 1 (24 × 24)	4016 × 4016	3008 × 3008	2000 × 2000
	16 : 9 (36 × 20)	6048 × 3400	4528 × 2544	3024 × 1696

## Flash Mode

Choose a flash mode for optional flash units. The options available depend on the mode selected with the mode dial.

Option	Available in	Option	Available in
 <b>Fill flash</b>	AUTO, P, S, A, M	 REAR <b>Rear-curtain sync</b>	P, S, A, M
 <b>Red-eye reduction</b>		 <b>Flash off</b>	AUTO, P, S, A, M
 SLOW <b>Slow sync + red-eye</b>	P, A		
 SLOW <b>Slow sync</b>			





The option currently selected is indicated by an icon in the display during shooting.





## Metering

Metering determines how the camera sets exposure. The following options are available:

Option	Description
 <b>Matrix metering</b>	The camera meters a wide area of the frame and sets exposure according to tone distribution, color, composition, and distance for results close to those seen by the naked eye.
 <b>Center-weighted metering</b>	The camera meters the entire frame but assigns the greatest weight to an area in the center of the frame, the size of which can be chosen using Custom Setting b3 ( <b>Center-weighted area</b> ). This is the classic meter for portraits and is also recommended when using filters with an exposure factor (filter factor) over 1 $\times$ .
 <b>Spot metering</b>	The camera meters a $\phi$ 4 mm circle (equivalent to approximately 1.5% of the frame) centered on the current focus point, making it possible to meter off-center subjects (if auto-area AF is in effect, the camera will instead meter the center focus point). Spot metering ensures that the subject will be correctly exposed, even when the background is much brighter or darker.
 * <b>Highlight-weighted metering</b>	The camera assigns the greatest weight to highlights. Use this option to reduce loss of detail in highlights, for example when photographing spotlight performers on-stage.

The option currently selected is indicated by an icon in the display during shooting.



## Wi-Fi Connection

Enable or disable Wi-Fi. Enable Wi-Fi to establish wireless connections to computers or between the camera and smartphones or tablets (smart devices) running the SnapBridge app.

The camera displays a Wi-Fi icon when Wi-Fi is enabled.



To turn Wi-Fi off, highlight **Wi-Fi connection** in the **i** menu and press **OK**. If Wi-Fi is currently enabled, a **Close Wi-Fi connection** prompt will be displayed; press **OK** to end the connection.

### Wireless Connections

For information on establishing wireless connections to computers or smart devices, see the *Network Guide*, available from the Nikon Download Center:

**Z7:** [https://downloadcenter.nikonimglib.com/en/products/492/Z\\_7.html](https://downloadcenter.nikonimglib.com/en/products/492/Z_7.html)



**Z6:** [https://downloadcenter.nikonimglib.com/en/products/493/Z\\_6.html](https://downloadcenter.nikonimglib.com/en/products/493/Z_6.html)









More information on using SnapBridge is available via the app's online help.



## Release Mode

Choose the operation performed when the shutter-release button is pressed all the way down. For more information, see “The  (Release Mode/Self-Timer) Button” (87).

Option	Option
 <b>Single frame</b>	 <b>Continuous H (extended)</b>
 <b>Continuous L</b>	 <b>Self-timer</b>
 <b>Continuous H</b>	

When **Continuous L** or **Self-timer** is highlighted, additional options can be displayed by pressing .

Pressing  when **Continuous L** is highlighted displays frame advance rate options.



Pressing  when **Self-timer** is highlighted displays options for the shutter-release delay and the number of shots taken when the timer expires.

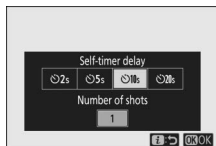





The current release mode is shown by icons in the shooting display and control panel.





## AF-Area Mode

AF-area mode controls how the camera selects the focus-point for autofocus. For more information, see “AF-Area Mode” (□ 54).

Option	Option
 <b>Pinpoint AF</b>	 <b>Wide-area AF (S)</b>
 <b>Single-point AF</b>	 <b>Wide-area AF (L)</b>
 <b>Dynamic-area AF</b>	 <b>Auto-area AF</b>

The option currently selected is shown by an icon in the display during shooting.



## Focus Mode

The focus mode controls how the camera focuses. For more information, see “Choosing a Focus Mode” (□ 52).

Option	Option
<b>AF-S Single AF</b>	<b>MF Manual focus</b>
<b>AF-C Continuous AF</b>	

The option currently selected is shown by an icon in the display during shooting.



## The Movie-Mode *i* Menu

At default settings, the following items appear in the *i* menu for movie mode.

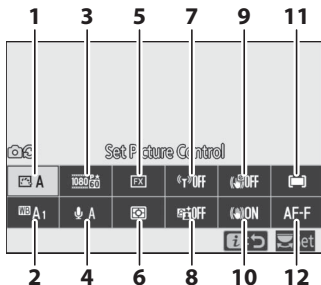

1 Set Picture Control.....	118	7 Wi-Fi connection.....	123
2 White balance.....	118	8 Active D-Lighting .....	123
3 Frame size and rate/ image quality .....	119	9 Electronic VR.....	123
4 Microphone sensitivity.....	121	10 Vibration reduction .....	124
5 Choose image area.....	122	11 AF-area mode .....	124
6 Metering .....	123	12 Focus mode.....	124

### "Same as Photo Settings"

If **Same as photo settings** is selected for **Set Picture Control, White balance, Active D-Lighting, or Vibration reduction** in the movie shooting menu, a  icon will appear at the top left corner of the *i* menu, indicating that the options selected for these settings in photo mode also apply in movie mode and vice versa.

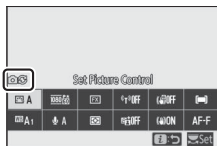

## **Set Picture Control**

Choose a Picture Control for movie recording. For more information, see “Set Picture Control” (📖 97).

## **White Balance**

Adjust white balance for movie recording. For more information, see “White Balance” (📖 64, 101).



## Frame Size, Frame Rate, and Movie Quality

Select the movie frame size (in pixels) and frame rate. You can also choose from two **Movie quality** options: **High quality** (indicated by frame size/rate icons with “★”) and **Normal**. Together, these options determine the maximum bit rate, as shown in the following table.

Frame size/frame rate <sup>1</sup>	Max. bit rate (Mbps)		Max. recording time
	High quality	Normal	
3840 × 2160 (4K UHD); 30p	144	— <sup>2</sup>	29 min. 59 s <sup>4</sup>
3840 × 2160 (4K UHD); 25p			
3840 × 2160 (4K UHD); 24p			
1920 × 1080; 120p <sup>3</sup>			
1920 × 1080; 100p <sup>3</sup>			
1920 × 1080; 60p	56	28	
1920 × 1080; 50p			
1920 × 1080; 30p	28	14	
1920 × 1080; 25p			
1920 × 1080; 24p			
1920 × 1080; 30p ×4 (slow-motion) <sup>3</sup>	36	— <sup>2</sup>	3 min.
1920 × 1080; 25p ×4 (slow-motion) <sup>3</sup>			
1920 × 1080; 24p ×5 (slow-motion) <sup>3</sup>			

1 Actual frame rates for values listed as 120p, 60p, 30p, and 24p are respectively 119.88 fps, 59.94 fps, 29.97 fps, and 23.976 fps.

2 **Movie quality** fixed at **High quality**.

3 Image area fixed at **DX** (Z 7) or **FX** (Z 6); face detection not enabled in auto-area AF AF-area mode.

4 Each movie may be recorded across up to 8 files of up to 4 GB each. The number of files and the length of each file vary with the options selected for **Frame size/frame rate** and **Movie quality**. Movies recorded to memory cards formatted in the camera will however be recorded as a single file regardless of size if the card has a capacity over 32 GB.

The option currently selected is shown by an icon in the display.

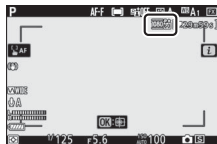

## ■ Slow-Motion Movies

To record silent slow-motion movies, select a “slow-motion” option for **Frame size/frame rate**. Slow-motion movies are recorded at 4 or 5 times the rated speed and play back at the rated speed. Movies shot at **1920 × 1080; 30p ×4 (slow-motion)**, for example, are recorded at a frame rate of roughly 120 fps and play back at around 30 fps, meaning that 10 seconds recording produces about 40 seconds of footage.

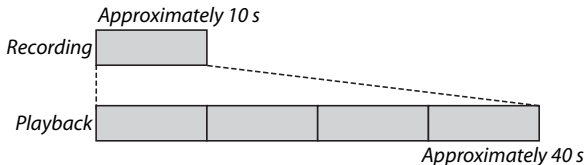

Recording and playback speeds are shown below.

	Frame size/frame rate	Recording speed	Normal
	1920 × 1080; 30p ×4 (slow-motion)	120p (119.88 fps)	30p (29.97 fps)
	1920 × 1080; 25p ×4 (slow-motion)	100p (100 fps)	25p (25 fps)
	1920 × 1080; 24p ×5 (slow-motion)	120p (119.88 fps)	24p (23.976 fps)

### Slow-Motion Movies

Features such as flicker reduction, electronic vibration reduction, and time code output cannot be used when a “slow-motion” option is selected.

## Microphone Sensitivity

Turn the built-in or external microphones on or off or adjust microphone sensitivity. Choose to adjust sensitivity automatically or **Microphone off** to turn sound recording off or adjust microphone sensitivity manually by choosing a value between and (the higher the value, the higher the sensitivity).

At settings other than , the option currently selected is shown by an icon in the display.

If the sound level is displayed in red, the volume is too high. Reduce microphone sensitivity.

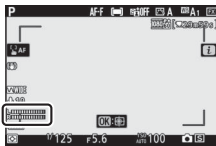
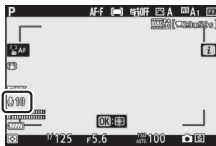

### The Icon

Movies recorded with the microphone off are indicated by a icon in full-frame and movie playback.



## Choose Image Area

Choose the size of the area on the image sensor used to record movies. Select **FX** to shoot movies in what is referred to as “FX-based movie format”, **DX** to shoot in “DX-based movie format”. The differences between the two formats are shown in the illustration.

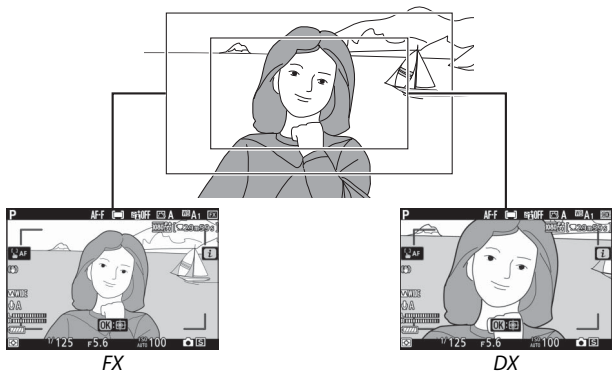

The dimensions of the area recorded vary with the frame size:

Format	Frame size	Area recorded (approximate)	
		Z7	Z6
FX-based movie format	3840 × 2160	35.9 × 20.2 mm	
	1920 × 1080	35.8 × 20.1 mm	35.9 × 20.1 mm
DX-based movie format	3840 × 2160	23.5 × 13.2 mm	23.4 × 13.2 mm
	1920 × 1080		23.4 × 13.1 mm

The option currently selected is shown by an icon in the display.



## Metering

Choose how the camera sets exposure in movie mode. For more information, see “Metering” (☞ 111), but note that spot metering is not available.

## Wi-Fi Connection

Enable or disable Wi-Fi. For more information, see “Wi-Fi Connection” (☞ 112).

## Active D-Lighting

Choose an Active D-Lighting option for movie mode. For more information, see “Active D-Lighting” (☞ 113). Note that if **Same as photo settings** is selected for **Active D-Lighting** in the movie shooting menu and **Auto** is selected in the photo shooting menu, movies will be shot at a setting equivalent to **Normal**.

## Electronic VR

Select **On** to enable electronic vibration reduction in movie mode. Electronic vibration reduction is not available at frame sizes of **1920 × 1080; 120p**, **1920 × 1080; 100p**, or 1920 × 1080 (slow-motion). Note that when electronic vibration reduction is on, the angle of view will be reduced, slightly increasing the apparent focal length, and the maximum sensitivity for movie recording is fixed at ISO 25600 (Z 7) or 51200 (Z 6).

An icon appears in the display while **On** is selected.

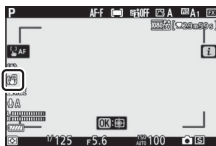





## **Vibration Reduction**

Choose vibration reduction option for movie mode. For more information, see “Vibration Reduction” (📖 115).

## **AF-Area Mode**

Choose how the camera selects the focus point when autofocus is enabled in movie mode. For more information, see “AF-Area Mode” (📖 54).

Option	Option
 <b>Single-point AF</b>	 <b>Wide-area AF (L)</b>
 <b>Wide-area AF (S)</b>	 <b>Auto-area AF</b>

## **Focus Mode**

Choose how the camera focuses in movie mode. For more information, see “Choosing a Focus Mode” (📖 52).

Option	Option
<b>AF-S</b> Single AF	<b>AF-F</b> Full-time AF
<b>AF-C</b> Continuous AF	<b>MF</b> Manual focus

# Menu List

This section lists the options available in the camera menus.

## Camera Menu

More information on camera menu is available in a *Reference Manual*, available for download from:

**Z7:** [https://downloadcenter.nikonimglib.com/en/products/492/Z\\_7.html](https://downloadcenter.nikonimglib.com/en/products/492/Z_7.html)



**Z6:** [https://downloadcenter.nikonimglib.com/en/products/493/Z\\_6.html](https://downloadcenter.nikonimglib.com/en/products/493/Z_6.html)



You can also consult the online manual, located at:  
[https://onlinemanual.nikonimglib.com/z7\\_z6/en/](https://onlinemanual.nikonimglib.com/z7_z6/en/)



## The Playback Menu: *Managing Images*

### Delete

Selected  Delete multiple images.

Select date

All

### Playback folder

(defaults to **All**)

(Folder name)  Choose a folder for playback.

All

Current

**Playback display options**

Add info	Choose the information available in the playback photo information display.
Focus point	
Additional photo info	
Exposure info	
Highlights	
RGB histogram	
Shooting data	
Overview	
None (image only)	

**Image review** (defaults to **Off**)

On	Choose whether pictures are displayed automatically immediately after shooting.
On (monitor only)	
Off	

**After delete** (defaults to **Show next**)

Show next	Choose the picture displayed after an image is deleted.
Show previous	
Continue as before	

**After burst, show** (defaults to **Last image in burst**)

First image in burst	Choose whether the camera displays the first or the last photo in the burst after photos are taken in continuous release mode.
Last image in burst	

**Rotate tall** (defaults to **On**)

On	Choose whether to rotate “tall” (portrait-orientation) pictures for display during playback.
Off	

**Slide show**

Start	View a slide show of the pictures in the current playback folder.
Image type	
Frame interval	

**Rating**

Rate selected images.



## The Photo Shooting Menu: *Shooting Options*

### Reset photo shooting menu

Yes	Select <b>Yes</b> to reset photo shooting menu options to their default values.
No	

### Storage folder

Rename	Select the folder in which subsequent pictures will be stored.
Select folder by number	
Select folder from list	

### File naming

File naming	Choose the three-letter prefix used in naming the image files in which photographs are stored. The default prefix is "DSC".
-------------	---

### Choose image area

(defaults to **FX (36 × 24)**)

FX (36 × 24)	Choose the image area (crop) for photos. <b>5 : 4 (30 × 24)</b> is available with the Z 7 only.
DX (24 × 16)	
5 : 4 (30 × 24)	
1 : 1 (24 × 24)	
16 : 9 (36 × 20)	

<b>Image quality</b>		(defaults to <b>JPEG normal</b> )
NEF (RAW) + JPEG fine ★	Choose a file format and compression ratio (image quality). The compression for options indicated by a star ("★") prioritizes quality, while that for images without a star gives priority to reducing file size.	
NEF (RAW) + JPEG fine		
NEF (RAW) + JPEG normal ★		
NEF (RAW) + JPEG normal		
NEF (RAW) + JPEG basic ★		
NEF (RAW) + JPEG basic		
NEF (RAW)		
JPEG fine ★		
JPEG fine		
JPEG normal ★		
JPEG normal		
JPEG basic ★		
JPEG basic		
TIFF (RGB)		
<b>Image size</b>		
JPEG/TIFF	Choose the image size, in pixels.	
NEF (RAW)	Separate options are available for JPEG/TIFF and for NEF (RAW) images.	
<b>NEF (RAW) recording</b>		
NEF (RAW) compression	Choose the type of compression and the bit depth for NEF (RAW) images.	
NEF (RAW) bit depth		
<b>ISO sensitivity settings</b>		
ISO sensitivity	Adjust ISO sensitivity settings for photographs.	
Auto ISO sensitivity control		

**White balance**(defaults to **Auto**)

Auto	Match white balance to the light source.
Natural light auto	
Direct sunlight	
Cloudy	
Shade	
Incandescent	
Fluorescent	
Flash	
Choose color temperature	
Preset manual	

**✓ Text Entry**

A keyboard is displayed when text entry is required. Tap letters on the screen (to cycle through the upper- and lower-case and symbol keyboards, tap the keyboard selection button) or use the multi selector to highlight characters and press **OK** to insert them at the current cursor position (note that if a character is entered when the field is full, the last character in the field will be deleted). To delete the character under the cursor, press the **⌫** button. To move the cursor to a new position, tap the display or rotate the main command dial. To complete entry and return to the previous menu, press **⌂**. To exit without completing text entry, press **MENU**.

*Text display area**Keyboard area**Keyboard selection*

**Set Picture Control**(defaults to **Auto**)

Auto	Choose how new photos will be processed. Select according to the type of scene or your creative intent.
Standard	
Neutral	
Vivid	
Monochrome	
Portrait	
Landscape	
Flat	
Dream	
Morning	
Pop	
Sunday	
Somber	
Dramatic	
Silence	
Bleached	
Melancholic	
Pure	
Denim	
Toy	
Sepia	
Blue	
Red	
Pink	
Charcoal	
Graphite	
Binary	
Carbon	

---

**Manage Picture Control**

Save/edit	Create custom Picture Controls.
Rename	
Delete	
Load/save	

**Color space**(defaults to **sRGB**)

sRGB	Choose a color space for photographs.
Adobe RGB	

**Active D-Lighting**(defaults to **Off**)

Auto	Preserve details in highlights and shadows, creating photographs with natural contrast.
Extra high	
High	
Normal	
Low	
Off	

**Long exposure NR**(defaults to **Off**)

On	Reduce “noise” (bright spots or fog) in photos taken at slow shutter speeds.
Off	

**High ISO NR**(defaults to **Normal**)

High	Reduce “noise” (randomly-spaced bright pixels) in photos taken at high ISO sensitivities.
Normal	
Low	
Off	

**Vignette control**(defaults to **Normal**)

High	Reduce the drop in brightness at the edges of photographs. The effect is most noticeable at maximum aperture.
Normal	
Low	
Off	

**Diffraction compensation**(defaults to **On**)

On	Reduce the effects of diffraction in photos taken at small apertures (high f/-numbers).
Off	

<b>Auto distortion control</b> (defaults to <b>On</b> )	
On	Reduce barrel distortion when shooting with wide-angle lenses and reduce pin-cushion distortion when shooting with long lenses (note that <b>On</b> may be selected automatically with some lenses, in which case the <b>Auto distortion control</b> option will be grayed out and unavailable).
Off	
<b>Flicker reduction shooting</b> (defaults to <b>Off</b> )	
On	Reduce the effects of flicker under fluorescent or mercury vapor lighting.
Off	
<b>Metering</b> (defaults to <b>Matrix metering</b> )	
Matrix metering	Choose how the camera meters light levels to set exposure.
Center-weighted metering	
Spot metering	
Highlight-weighted metering	
<b>Flash control</b>	
Flash control mode	Choose a flash control mode for optional flash units and adjust settings for remote wireless flash units. The options available vary with the flash unit or accessory used.
Wireless flash options	
Remote flash control	
Radio remote flash info	
<b>Flash mode</b> (defaults to <b>Fill flash</b> )	
Fill flash	Choose the flash mode.
Red-eye reduction	
Slow sync + red-eye	
Slow sync	
Rear-curtain sync	
Flash off	
<b>Flash compensation</b> (defaults to <b>0.0</b> )	
-3.0 – +1.0	Adjust flash compensation.

<b>Focus mode</b>	(defaults to <b>Single AF</b> )
Single AF	Choose how the camera focuses.
Continuous AF	
Manual focus	
<b>AF-area mode</b>	(defaults to <b>Single-point AF</b> )
Pinpoint AF	Choose how the camera selects the focus point for autofocus.
Single-point AF	
Dynamic-area AF	
Wide-area AF (S)	
Wide-area AF (L)	
Auto-area AF	
<b>Vibration reduction</b>	
On	Reduce blur caused by camera shake.
Normal	The options available vary with the lens.
Sport	
Off	
<b>Auto bracketing</b>	
Auto bracketing set	Adjust auto bracketing settings.
Number of shots	
Increment	
Amount	
<b>Multiple exposure</b>	
Multiple exposure mode	Record from two to ten NEF (RAW) exposures as a single photograph.
Number of shots	
Overlay mode	
Keep all exposures	
Overlay shooting	
Select first exposure (NEF)	
<b>HDR (high dynamic range)</b>	
HDR mode	Preserve details in highlights and shadows when photographing high-contrast scenes.
Exposure differential	
Smoothing	
Save individual images (NEF)	

**Interval timer shooting**

Start	Take photographs at the selected interval until the specified number of shots has been recorded.
Choose start day/time	
Interval	
Intervals×shots/interval	
Exposure smoothing	
Silent photography	
Interval priority	
Starting storage folder	

**Time-lapse movie**

Start	The camera automatically takes photos at selected intervals to create a silent time-lapse movie.
Interval	
Shooting time	
Exposure smoothing	
Silent photography	
Choose image area	
Frame size/frame rate	
Interval priority	

**Focus shift shooting**

Start	Automatically vary focus over a series of photographs.
No. of shots	
Focus step width	
Interval until next shot	
First-frame exposure lock	
Peaking stack image	
Silent photography	
Starting storage folder	

**Silent photography**(defaults to **Off**)

On	Eliminate the sound of the shutter.
Off	



## The Movie Shooting Menu: *Movie Shooting Options*

### Reset movie shooting menu

Yes	Select <b>Yes</b> to reset movie shooting menu options to their default values.
No	

### File naming

Choose the three-letter prefix used in naming the image files in which movies are stored. The default prefix is "DSC".

### Choose image area

(defaults to **FX**)

FX	Choose the image area (crop) for movies.
DX	

### Frame size/frame rate

(defaults to **1920×1080; 60p**)

3840×2160; 30p	Choose movie frame size (measured in pixels) and frame rate.
3840×2160; 25p	
3840×2160; 24p	
1920×1080; 120p	
1920×1080; 100p	
1920×1080; 60p	
1920×1080; 50p	
1920×1080; 30p	
1920×1080; 25p	
1920×1080; 24p	
1920×1080; 30p ×4 (slow-mo)	
1920×1080; 25p ×4 (slow-mo)	
1920×1080; 24p ×5 (slow-mo)	

<b>Movie quality</b>	(defaults to <b>High quality</b> )
High quality	Choose movie quality.
Normal	
<b>Movie file type</b>	(defaults to <b>MOV</b> )
MOV	Choose the movie file type.
MP4	
<b>ISO sensitivity settings</b>	
Maximum sensitivity	Adjust ISO sensitivity settings for movies.
Auto ISO control (mode M)	
ISO sensitivity (mode M)	
<b>White balance</b>	(defaults to <b>Same as photo settings</b> )
Same as photo settings	Choose the white balance for movies.
Auto	Select <b>Same as photo settings</b> to use the option currently selected for photos.
Natural light auto	
Direct sunlight	
Cloudy	
Shade	
Incandescent	
Fluorescent	
Choose color temperature	
Preset manual	

**Set Picture Control**(defaults to **Same as photo settings**)

Same as photo settings

Choose a Picture Control for movies.

Auto

Select **Same as photo settings** to use the option currently selected for photos.

Standard

Neutral

Vivid

Monochrome

Portrait

Landscape

Flat

Dream

Morning

Pop

Sunday

Somber

Dramatic

Silence

Bleached

Melancholic

Pure

Denim

Toy

Sepia

Blue

Red

Pink

Charcoal

Graphite

Binary

Carbon

<b>Manage Picture Control</b>	
Save/edit	Create custom Picture Controls.
Rename	
Delete	
Load/save	
<b>Active D-Lighting</b> (defaults to <b>Off</b> )	
Same as photo settings	Preserve details in highlights and shadows, creating movies with natural contrast. Select <b>Same as photo settings</b> to use the option currently selected for photos.
Extra high	
High	
Normal	
Low	
Off	
<b>High ISO NR</b> (defaults to <b>Normal</b> )	
High	Reduce "noise" (randomly-spaced bright pixels) in movies recorded at high ISO sensitivities.
Normal	
Low	
Off	
<b>Vignette control</b> (defaults to <b>Normal</b> )	
Same as photo settings	Reduce the drop in brightness at the edges of the frame. Select <b>Same as photo settings</b> to use the option currently selected for photos.
High	
Normal	
Low	
Off	
<b>Diffraction compensation</b> (defaults to <b>On</b> )	
On	Reduce the effects of diffraction in movies taken at small apertures (high f/-numbers).
Off	

<b>Auto distortion control</b> (defaults to <b>On</b> )	
On	Reduce barrel distortion when shooting with wide-angle lenses and reduce pin-cushion distortion when shooting with long lenses (note that <b>On</b> may be selected automatically with some lenses, in which case the <b>Auto distortion control</b> option will be grayed out and unavailable).
Off	
<b>Flicker reduction</b> (defaults to <b>Auto</b> )	
Auto	Reduce flicker and banding caused by fluorescent or mercury-vapor lighting during movie recording.
50 Hz	
60 Hz	
<b>Metering</b> (defaults to <b>Matrix metering</b> )	
Matrix metering	Choose how the camera meters light levels to set exposure when filming movies.
Center-weighted metering	
Highlight-weighted metering	
<b>Focus mode</b> (defaults to <b>Full-time AF</b> )	
Single AF	Choose how the camera focuses.
Continuous AF	
Full-time AF	
Manual focus	
<b>AF-area mode</b> (defaults to <b>Auto-area AF</b> )	
Single-point AF	Choose how the camera selects the focus point for autofocus.
Wide-area AF (S)	
Wide-area AF (L)	
Auto-area AF	
<b>Vibration reduction</b> (defaults to <b>Same as photo settings</b> )	
Same as photo settings	Reduce blur caused by camera shake. The options available vary with the lens.
On	
Normal	Select <b>Same as photo settings</b> to use the option currently selected for photos.
Sport	
Off	

<b>Electronic VR</b> (defaults to <b>Off</b> )	
On	Choose whether to enable electronic vibration reduction in movie mode.
Off	
<b>Microphone sensitivity</b> (defaults to <b>Auto</b> )	
Auto	Turn the built-in or external microphones on or off or adjust microphone sensitivity.
Manual	
Microphone off	
<b>Attenuator</b> (defaults to <b>Disable</b> )	
Enable	Reduce microphone gain and prevent audio distortion when recording movies in loud environments.
Disable	
<b>Frequency response</b> (defaults to <b>Wide range</b> )	
Wide range	Choose the frequency response for the built-in and external microphones.
Vocal range	
<b>Wind noise reduction</b> (defaults to <b>Off</b> )	
On	Choose whether to enable the built-in microphone's low-cut filter to reduce wind noise.
Off	
<b>Headphone volume</b> (defaults to <b>15</b> )	
0–30	Adjust volume for third-party headphones.
<b>Timecode</b>	
Record timecodes	Adjust time code settings and choose whether to record time codes with movies.
Count-up method	
Timecode origin	
Drop frame	

## Custom Settings: *Fine-Tuning Camera Settings*

### Reset custom settings

Yes	Select <b>Yes</b> to reset Custom Settings to their default values.
No	

### a Autofocus

#### a1 AF-C priority selection (defaults to **Release**)

Release	Choose whether photos can be taken before the camera has focused in focus mode <b>AF-C</b> .
Focus	

#### a2 AF-S priority selection (defaults to **Focus**)

Release	Choose whether photos can be taken before the camera has focused in focus mode <b>AF-S</b> .
Focus	

#### a3 Focus tracking with lock-on (defaults to **3**)

Blocked shot AF response	Choose how autofocus responds to changes in the distance to the subject in focus mode <b>AF-C</b> .
--------------------------	---

#### a4 Auto-area AF face/eye detection (defaults to **Face and eye detection on**)

Face and eye detection on	Choose whether the camera detects human portrait subjects or dogs and cats and focuses on their faces or on their faces and eyes when auto-area AF is selected for AF-area mode.
Face detection on	
Animal detection	
Off	

#### a5 Focus points used (defaults to **All points**)

All points	Choose the number of focus points available for manual focus-point selection.
Every other point	

#### a6 Store points by orientation (defaults to **No**)

Yes	Choose whether the camera stores the focus points for “tall” and “wide” orientations separately.
No	

<b>a7 AF activation</b> (defaults to <b>Shutter/AF-ON</b> )	
Shutter/AF-ON	Choose whether the camera focuses when the shutter-release button is pressed halfway. If <b>AF-ON only</b> is selected, the camera will not focus when the shutter-release button is pressed halfway.
AF-ON only	
<b>a8 Limit AF-area mode selection</b>	
Pinpoint AF	Choose the options that can be selected by rotating the sub-command dial when AF-area mode is assigned to the <b>i</b> menu or a camera control.
Single-point AF	
Dynamic-area AF	
Wide-area AF (S)	
Wide-area AF (L)	
Auto-area AF	
<b>a9 Focus point wrap-around</b> (defaults to <b>No wrap</b> )	
Wrap	Choose whether focus-point selection “wraps around” from one edge of the display to another.
No wrap	
<b>a10 Focus point options</b>	
Manual focus mode	Adjust settings for the focus-point display.
Dynamic-area AF assist	
<b>a11 Low-light AF</b> (defaults to <b>Off</b> )	
On	Choose <b>On</b> for more accurate (if sometimes slower) focus in low light when <b>AF-S</b> is selected for focus mode.
Off	
<b>a12 Built-in AF-assist illuminator</b> (defaults to <b>On</b> )	
On	Choose whether the AF-assist illuminator lights to assist focus when lighting is poor.
Off	



<b>a13 Manual focus ring in AF mode</b> (defaults to <b>Enable</b> )	
Enable	This option is available with compatible lenses. Select <b>Disable</b> to prevent the focus ring being used for focus in autofocus mode.
Disable	
<b>b Metering/exposure</b>	
<b>b1 EV steps for exposure cntrl</b> (defaults to <b>1/3 step</b> )	
1/3 step	Select the size of the increment for adjustments to shutter speed, aperture, ISO sensitivity, and exposure and flash bracketing and compensation.
1/2 step	
<b>b2 Easy exposure compensation</b> (defaults to <b>Off</b> )	
On (Auto reset)	Choose whether exposure compensation can be adjusted solely by rotating a command dial, without pressing the  button.
On	
Off	
<b>b3 Center-weighted area</b> (defaults to $\phi$ <b>12 mm</b> )	
$\phi$ 12 mm	Choose the size of the area given the most weight in center-weighted metering.
Average	
<b>b4 Fine-tune optimal exposure</b>	
Matrix metering	Fine-tune exposure for each metering method. Higher values produce brighter exposures, lower values darker exposures.
Center-weighted metering	
Spot metering	
Highlight-weighted metering	
<b>c Timers/AE lock</b>	
<b>c1 Shutter-release button AE-L</b> (defaults to <b>Off</b> )	
On (half press)	Choose whether exposure locks when the shutter-release button is pressed.
On (burst mode)	
Off	
<b>c2 Self-timer</b>	
Self-timer delay	Choose the length of the shutter release delay, the number of shots taken, and the interval between shots in self-timer mode.
Number of shots	
Interval between shots	

<b>c3 Power off delay</b>	
Playback	Choose how long the control panel and camera displays remain on when no operations are performed.
Menus	
Image review	
Standby timer	
<b>d Shooting/display</b>	
<b>d1 CL mode shooting speed</b> (defaults to <b>3 fps</b> )	
5 fps–1 fps	Choose the frame advance rate for low-speed continuous release mode.
<b>d2 Max. continuous release</b> (defaults to <b>200</b> )	
1–200	Choose the maximum number of shots that can be taken in a single burst in continuous release modes.
<b>d3 Sync. release mode options</b> (defaults to <b>Sync</b> )	
Sync	Choose whether the shutter releases on remote cameras synchronize with the shutter release on the master camera.
No sync	
<b>d4 Exposure delay mode</b> (defaults to <b>Off</b> )	
3 s–0.2 s, Off	In situations in which the slightest camera movement can blur pictures, shutter release can be delayed until approximately 0.2 to 3 seconds after the shutter-release button is pressed.
<b>d5 Shutter type</b> (defaults to <b>Auto</b> )	
Auto	Choose the type of shutter used for photographs.
Mechanical shutter	
Electronic front-curtain shutter	
<b>d6 Limit selectable image area</b>	
FX (36 × 24)	Choose the options available when image-area selection is assigned to the <b>z</b> menu or to the command dials and a camera control. <b>5 : 4 (30 × 24)</b> is available with the Z 7 only.
DX (24 × 16)	
5 : 4 (30 × 24)	
1 : 1 (24 × 24)	
16 : 9 (36 × 20)	

<b>d7 File number sequence</b>		(defaults to <b>On</b> )
On	Choose how the camera assigns file numbers.	
Off		
Reset		
<b>d8 Apply settings to live view</b>		(defaults to <b>On</b> )
On	When <b>On</b> is selected, the effects of camera settings on color and brightness can be previewed in the viewfinder or monitor shooting display.	
Off		
<b>d9 Framing grid display</b>		(defaults to <b>Off</b> )
On	Choose <b>On</b> to display a grid for reference when framing shots.	
Off		
<b>d10 Peaking highlights</b>		
Peaking level	Adjust settings for the manual focus peaking display, which uses outlines to show objects that are in focus.	
Peaking highlight color		
<b>d11 View all in continuous mode</b>		(defaults to <b>On</b> )
On	If <b>Off</b> is selected, the display will go blank during burst photography.	
Off		
<b>e Bracketing/flash</b>		
<b>e1 Flash sync speed</b>		(defaults to <b>1/200 s</b> )
1/200 s (Auto FP)–1/60 s	Choose a flash sync speed.	
<b>e2 Flash shutter speed</b>		(defaults to <b>1/60 s</b> )
1/60 s–30 s	Choose the slowest shutter available when the flash is used in modes <b>P</b> and <b>A</b> .	
<b>e3 Exposure comp. for flash</b>		(defaults to <b>Entire frame</b> )
Entire frame	Choose how the camera adjusts flash level when exposure compensation is used.	
Background only		

<b>e4 Auto  ISO sensitivity control</b>		(defaults to <b>Subject and background</b> )
Subject and background	Choose whether auto ISO sensitivity control for flash photography is adjusted to correctly expose both the subject and background or the main subject only.	
Subject only		
<b>e5 Modeling flash</b>		(defaults to <b>On</b> )
On	Choose <b>On</b> to preview lighting effects when using optional flash units compatible with the Nikon Creative Lighting System.	
Off		
<b>e6 Auto bracketing (mode M)</b>		(defaults to <b>Flash/speed</b> )
Flash/speed	Choose the settings affected when exposure and/or flash bracketing is enabled in mode <b>M</b> .	
Flash/speed/aperture		
Flash/aperture		
Flash only		
<b>e7 Bracketing order</b>		(defaults to <b>MTR &gt; under &gt; over</b> )
MTR > under > over	Choose the bracketing order for exposure, flash, and white balance bracketing.	
Under > MTR > over		

#### **Fixing Shutter Speed at the Flash Sync Speed Limit**

To fix shutter speed at the sync speed limit in mode **S** or **M**, choose a speed one setting slower than the slowest speed possible (30 s or **Time**). A flash sync indicator (“X”) will appear in the display and control panel together with the flash sync speed.

#### **Auto FP High-Speed Sync**

Auto FP high-speed sync allows the flash to be used at the highest shutter speed supported by the camera, making it possible to choose the maximum aperture for reduced depth of field even in bright sunlight. The flash information display shows “FP” when **1/200 s (Auto FP)** is selected.

## f Controls

### f1 Customize menu

Choose image area

Image quality

Image size

Exposure compensation

ISO sensitivity settings

White balance

Set Picture Control

Color space

Active D-Lighting

Long exposure NR

High ISO NR

Metering

Flash mode

Flash compensation

Focus mode

AF-area mode

Vibration reduction

Auto bracketing

Multiple exposure

HDR (high dynamic range)

Silent photography

Release mode

Custom control assignment

Exposure delay mode

Electronic front-curtain shutter

Apply settings to live view

Split-screen display zoom

Peaking highlights

Monitor/viewfinder brightness

Bluetooth connection

Wi-Fi connection

Choose the options displayed in the  menu for photo mode.

## f2 Custom control assignment

Fn1 button	Choose the functions performed by camera controls in photo mode.
Fn2 button	
AF-ON button	
Sub-selector	
Sub-selector center	
Movie record button	
Lens Fn button	
Lens Fn2 button	
Lens control ring	

## f3 OK button

Shooting mode	Choose the role assigned to the  button during shooting (photo mode) and playback.
Playback mode	

## f4 Shutter spd & aperture lock

Shutter speed lock	Lock shutter speed at the value currently selected in mode <b>S</b> or <b>M</b> , or aperture at the value currently selected in mode <b>A</b> or <b>M</b> .
Aperture lock	



## f5 Customize command dials

Reverse rotation	Customize the operation of the main and sub-command dials.
Change main/sub	
Menus and playback	
Sub-dial frame advance	

## f6 Release button to use dial (defaults to **No**)

Yes	Selecting <b>Yes</b> allows adjustments that are normally made by holding a button and rotating a command dial to be made by rotating the command dial after the button is released.
No	

## f7 Reverse indicators (defaults to )

	Choose whether the exposure indicator is displayed with positive values at the right and negative values at the left or vice-versa.
	

## g Movie

### g1 Customize menu

Choose image area	Choose the options displayed in the <b>i</b> menu for movie mode.
Frame size and rate/Image quality	
Exposure compensation	
ISO sensitivity settings	
White balance	
Set Picture Control	
Active D-Lighting	
Metering	
Focus mode	
AF-area mode	
Vibration reduction	
Electronic VR	
Microphone sensitivity	
Attenuator	
Frequency response	
Wind noise reduction	
Headphone volume	
Peaking highlights	
Highlight display	
Monitor/viewfinder brightness	
Bluetooth connection	
Wi-Fi connection	

### g2 Custom control assignment

Fn1 button	Choose the functions performed by camera controls in movie mode. Note that if <b>Record movies</b> is selected for <b>Shutter-release button</b> , the shutter-release button cannot be used for any operation other than recording movies.
Fn2 button	
AF-ON button	
Sub-selector center	
Shutter-release button	
Lens control ring	

<b>g3 OK button</b> (defaults to <b>Select center focus point</b> )	
Select center focus point	Choose the role assigned to the <b>OK</b> button in movie mode.
Zoom on/off	
Record movies	
None	
<b>g4 AF speed</b>	
-5 - +5	Choose the focus speed for movie mode.
When to apply	
<b>g5 AF tracking sensitivity</b> (defaults to <b>4</b> )	
1 - 7	Choose the speed of the focus response in movie mode.
<b>g6 Highlight display</b>	
Display pattern	Choose how highlights (bright areas of the frame) are shown in movie mode.
Highlight display threshold	

## Y The Setup Menu: *Camera Setup*

<b>Format memory card</b>	
	Select <b>Yes</b> to format the memory card. <i>Note that formatting permanently deletes all pictures and other data on the card. Be sure to make backup copies before formatting.</i>
<b>Save user settings</b>	
Save to U1	Save current settings to the selected mode dial position.
Save to U2	
Save to U3	
<b>Reset user settings</b>	
Reset U1	Reset settings for the selected mode dial position to default values.
Reset U2	
Reset U3	



<b>Language</b>	
	Choose a language for camera menus and messages. The languages available vary with the country or region in which the camera was originally purchased.
<b>Time zone and date</b>	
Time zone	Set the camera clock.
Date and time	
Date format	
Daylight saving time	
<b>Monitor brightness</b> (defaults to <b>0</b> )	
-5 – +5	Adjust monitor brightness.
<b>Monitor color balance</b>	
	Adjust monitor color balance.
<b>Viewfinder brightness</b> (defaults to <b>Auto</b> )	
Auto	Adjust viewfinder brightness.
Manual	
<b>Viewfinder color balance</b>	
	Adjust viewfinder color balance.
<b>Control panel brightness</b> (defaults to <b>Auto</b> )	
Auto	Adjust control panel brightness.
Manual	
Off	
<b>Limit monitor mode selection</b>	
Automatic display switch	Choose the monitor modes that can be selected using the monitor mode button.
Viewfinder only	
Monitor only	
Prioritize viewfinder	
<b>Information display</b> (defaults to <b>Dark on light</b> )	
Dark on light	Adjust the information display for different viewing conditions.
Light on dark	

<b>AF fine-tune</b>	
AF fine-tune (On/Off)	Fine-tune focus for different lens types.
Saved value	Use only when required.
Default	
List saved values	
<b>Non-CPU lens data</b>	
Lens number	Record information on non-CPU lenses attached via a mount adapter.
Focal length (mm)	
Maximum aperture	
<b>Clean image sensor</b>	
Clean now	Vibrate the image sensor to remove dust.
Automatic cleaning	
<b>Image Dust Off ref photo</b>	
Start	Acquire reference data for the Image Dust Off option in Capture NX-D.
Clean sensor and then start	
<b>Image comment</b>	
Attach comment	Add a comment to new pictures as they are taken. Comments can be viewed as metadata in ViewNX-i or Capture NX-D.
Input comment	
<b>Copyright information</b>	
Attach copyright information	Add copyright information to new pictures as they are taken. Copyright information can be viewed as metadata in ViewNX-i or Capture NX-D.
Artist	
Copyright	
<b>Beep options</b>	
Beep on/off	Choose the pitch and volume of beeps made by the camera.
Volume	
Pitch	
<b>Touch controls</b>	
Enable/disable touch controls	Adjust touch control settings.
Full-frame playback flicks	

## HDMI

Output resolution	Adjust settings for connection to HDMI devices.
Advanced	
Output range	
External recording control	
Output data depth	
N-Log setting	
View assist	

## Location data

Standby timer	Adjust location data settings.
Position	
Set clock from satellite	

## Wireless remote (WR) options

LED lamp	Adjust LED lamp and link mode settings for optional wireless remote controllers.
Link mode	

## Assign remote (WR) Fn button

(defaults to **None**)

AF-ON	Choose the role played by the <b>Fn</b> button on optional wireless remote controllers.
AF lock only	
AE lock (Reset on release)	
AE lock only	
AE/AF lock	
FV lock	
 Disable/enable	
Preview	
+ NEF (RAW)	
None	

**Airplane mode** (defaults to **Disable**)

Enable	Select <b>Enable</b> to disable the camera's built-in Bluetooth and Wi-Fi functions. The Bluetooth and Wi-Fi functions of optional peripheral devices connected to the camera can only be disabled by disconnecting the devices.
Disable	

**Connect to smart device**

Pairing (Bluetooth)	Connect to a smart phone or tablet and adjust settings once connected. See SnapBridge online help or the <i>Network Guide</i> .
Select to send (Bluetooth)	
Wi-Fi connection	
Send while off	

**Connect to PC**

Wi-Fi connection	Adjust settings for connection to computers using the camera's built-in Wi-Fi. For more information, see the <i>Network Guide</i> .
Connection type	
Network settings	
Options	
MAC address	

**Wireless Connections**

For information on establishing wireless connections to computers or smart devices, see the *Network Guide*, available from the Nikon Download Center:

**Z7:** [https://downloadcenter.nikonimglib.com/en/products/492/Z\\_7.html](https://downloadcenter.nikonimglib.com/en/products/492/Z_7.html)



**Z6:** [https://downloadcenter.nikonimglib.com/en/products/493/Z\\_6.html](https://downloadcenter.nikonimglib.com/en/products/493/Z_6.html)



## Wireless transmitter (WT-7)

Wireless transmitter	Adjust settings for connection to computers or ftp servers via wireless or Ethernet networks using an optional WT-7 wireless transmitter. This option is available only when a WT-7 is connected.
Choose hardware	
Network settings	
Options	

## Conformity marking

View some of the standards with which the camera complies.

## Battery info

View information on the battery currently inserted in the camera.

## Slot empty release lock

(defaults to **Enable release**)

Release locked	Choose whether the shutter can be released when no memory card is inserted.
Enable release	

## Save/load settings

Save settings	Save camera settings to or load camera settings from a memory card. Settings files can be shared with other cameras of the same model.
Load settings	

## Reset all settings

Reset	Reset all settings except <b>Language</b> and <b>Time zone and date</b> to their default values.
Do not reset	

## Firmware version

View the current camera firmware version.

### "Reset All Settings"

Copyright information and other user-generated entries are also reset. We recommend that you save settings using the **Save/load settings** option in the setup menu before performing a reset.

## **The Retouch Menu:** ***Creating Retouched Copies***

### **NEF (RAW) processing**

Select image(s)	Create JPEG copies of NEF (RAW) photographs.
Select date	
Select all images	

### **Trim**

Create a cropped copy of the selected photograph.

### **Resize**

Select image(s)	Create small copies of selected photographs.
Choose size	

### **D-Lighting**

Brighten shadows.

### **Red-eye correction**

Correct “red-eye” in photos taken with a flash.

### **Straighten**

Create straightened copies. Copies can be straightened by up to 5° in increments of approximately 0.25°.

### **Distortion control**

Auto	Reduce barrel distortion in photos taken with wide-angle lenses or pin-cushion distortion in photos taken with telephoto lenses. Select <b>Auto</b> to let the camera correct distortion automatically.
Manual	

### **Perspective control**

Reduce the effects of perspective in photos taken looking up from the base of a tall object.

### Image overlay

Combine two existing NEF (RAW) photos to create a single picture that is saved separately from the originals. This option is only available in the  tab.

### Trim movie

Trim footage to create edited copies of movies.

### Side-by-side comparison

Compare retouched copies to the original photographs. This option can only be accessed by pressing the  button and selecting **Retouch** when a copy or original is displayed.

## ☰ My Menu/⌚ Recent Settings

### Add items

PLAYBACK MENU	Create a custom menu of up to 20 items selected from the playback, photo shooting, movie shooting, Custom Setting, setup, and retouch menus.
PHOTO SHOOTING MENU	
MOVIE SHOOTING MENU	
CUSTOM SETTING MENU	
SETUP MENU	
RETOUCH MENU	

### Remove items

Delete items from My Menu.

### Rank items

Change the order of the items in My Menu.

### Choose tab

(defaults to **MY MENU**)

MY MENU	Choose the menu displayed in the “My Menu/Recent Settings” tab. Select <b>RECENT SETTINGS</b> to display a menu listing the 20 most recently-used settings.
RECENT SETTINGS	



# Troubleshooting

You may be able to resolve any issues with the camera by following the steps below. Check this list before consulting your retailer or Nikon-authorized service representative.

STEP 1

**Check the common problems listed in the following sections:**

- “Problems and Solutions” (□ 160)
- “Indicators and Error Messages” (□ 166)

STEP 2

**Turn the camera off and remove the battery. After waiting for about a minute, re-insert the battery and turn the camera on.**

- If you have just finished shooting, wait at least a minute before removing the battery, as the camera may still be writing data to the memory card.

STEP 3

**Search Nikon websites.**

For support information and answers to frequently asked questions, visit the website for your country or region (□ xv). To download the latest firmware for your camera, visit:  
<https://downloadcenter.nikonimglib.com>

STEP 4

**Consult a Nikon-authorized service representative.**

## Restoring Default Settings

Depending on current settings, some menu items and other features may be unavailable. To access menu items that are grayed out or features that are otherwise unavailable, try restoring default settings using the **Reset all settings** item in the setup menu (□ 155). Note, however, that wireless network profiles, copyright information, and other user-generated entries will also be reset. We recommend that you save settings using the **Save/load settings** option in the setup menu before performing a reset.

## Problems and Solutions

Solutions to some common issues are listed below.

### Battery/Display

---

**The camera is on but does not respond:** Wait for recording to end. If the problem persists, turn the camera off. If the camera does not turn off, remove and reinsert the battery or, if you are using an AC adapter, disconnect and reconnect the AC adapter. Note that although any data currently being recorded will be lost, data that have already been recorded will not be affected by removing or disconnecting the power source.

---

**The viewfinder or monitor does not turn on:**

- Choose a different monitor mode using the monitor mode button (note that you may first need to enable the desired mode using the **Limit monitor mode selection** option in the setup menu).
  - Dust, lint, or other foreign matter on the eye sensor may prevent it functioning normally. Clean the eye sensor with a blower.
- 

**The viewfinder is out of focus:** Rotate the diopter adjustment control to focus the viewfinder. If this does not correct the problem, select **AF-S**, single-point AF, and the center focus point, and then frame a high-contrast subject in the center focus point and press the shutter-release button halfway to focus the camera. With the camera in focus, use the diopter adjustment control to bring the subject into clear focus in the viewfinder.

---

**The displays turn off without warning:** Choose longer delays for Custom Setting c3 (**Power off delay**).

---

**The control panel is unresponsive and dim:** Control panel response times and brightness vary with temperature.

---

## Shooting

---

**The camera takes time to turn on:** Delete files or folders.

---

**The shutter-release is disabled:**

- The memory card is full.
  - **Release locked** is selected for **Slot empty release lock** in the setup menu and no memory card is inserted.
  - Mode **S** selected with **Bulb** or **Time** chosen for shutter speed.
- 

**The camera is slow to respond to the shutter-release button:** Select **Off** for Custom Setting d4 (**Exposure delay mode**).

---

**Only one shot is taken each time the shutter-release button is pressed in continuous release modes:** Turn HDR off.

---

**Photos are out of focus:** To focus using autofocus, select **AF-S**, **AF-C**, or **AF-F** for focus mode. If the camera is unable to focus using autofocus (□ 53), use manual focus or focus lock.

---

**Beeps do not sound:**

- **Off** is selected for **Beep options > Beep on/off** in the setup menu.
  - **AF-C** is selected for focus mode.
  - **On** is selected for **Silent photography** in the photo shooting menu.
  - The camera is in movie mode.
- 

**The full range of shutter speeds is not available:** A flash in use. Flash sync speed can be selected using Custom Setting e1 (**Flash sync speed**); when using compatible flash units, choose **1/200 s (Auto FP)** to access the full range of shutter speeds.

---

**Focus does not lock when the shutter-release button is pressed halfway:** When **AF-C** is selected for focus mode, focus can be locked by pressing the center of the sub-selector.

---

**The focus point cannot be changed:** Focus-point selection is unavailable in auto-area AF; choose another AF-area mode.

---

**The camera is slow to record photos:** Turn long exposure noise reduction off.

---

---

**Photographs and movies do not appear to have the same exposure as the preview shown in the display:** To preview the effects of changes to settings that affect exposure and color, select **On** for Custom Setting d8 (**Apply settings to live view**). Note that changes to **Monitor brightness** and **Viewfinder brightness** have no effect on images recorded with the camera.

---

**Flicker or banding appears in movie mode:** Select **Flicker reduction** in the movie shooting menu and choose an option that matches the frequency of the local AC power supply.

---

**Bright regions or bands appear in the view through the lens:** The shot is being framed under flashing sign, flash, or other light source with brief duration.

---

**Smudges appear in photographs:** Clean the front and rear lens elements. If the problem persists, perform image sensor cleaning.

---

**Bokeh is irregular:** With fast shutter speeds and/or fast lenses, you may notice irregularities in how *bokeh* is shaped. The effect can be mitigated by choosing slower shutter speeds and/or higher f-numbers.

---

**Shooting ends unexpectedly or does not start:** Shooting may end automatically to prevent damage to the camera's internal circuits if the ambient temperature is high or the camera has been used extensively for burst shooting, movie recording, or the like. If you are unable to shoot because the camera has overheated, wait for the internal circuits to cool and then try again. Note that the camera may feel warm to the touch, but this does not indicate a malfunction.

---

**Image artifacts appear in the display during shooting:** "Noise" (randomly-spaced bright pixels, fog, or lines) and unexpected colors may appear if you zoom in on the view through the lens. Randomly-spaced bright pixels, fog, or bright spots may also arise as a result of increases in the temperature of the camera's internal circuits during shooting; turn the camera off when it is not in use. At high ISO sensitivities, noise may become more noticeable in long exposures or in pictures recorded when the camera temperature is elevated. Note that the distribution of noise in the display may differ from that in the final picture. To reduce noise, adjust settings such as ISO sensitivity, shutter speed, or Active D-Lighting.

---

---

**The camera cannot measure white balance:** The subject is too dark or too bright.

**Images cannot be selected as source for preset white balance:** The images in question were created with a different model of camera.

---

**White balance bracketing is unavailable:**

- An NEF (RAW) or NEF+JPEG image quality option is selected for image quality.
- Multiple exposure or HDR (high dynamic range) photography is on.

---

**The effects of Picture Controls differ from image to image:** **Auto** is selected for **Set Picture Control**, a Picture Control based on **Auto** is selected, or **A** (auto) is selected for **Quick sharp**, contrast, or saturation. For consistent results over a series of photographs, choose another setting.

---

**Metering cannot be changed:** Autoexposure lock is in effect.

---

**Exposure compensation cannot be used:** Choose mode **P**, **S**, or **A**.

---

**Noise (colored splotches or other artifacts) appears in long time-exposures:** Enable long exposure noise reduction.

---

**The AF-assist illuminator does not light:**

- Select **On** for Custom Setting a12 (**Built-in AF-assist illuminator**).
- The illuminator does not light in movie mode or when **AF-C** or **MF** is selected for focus mode.

---

**Sound is not recorded with movies:** **Microphone off** is selected for

**Microphone sensitivity** in the movie shooting menu.

---

## **Playback**

---

**NEF (RAW) images are not played back:** The pictures were taken at image qualities of NEF + JPEG.

---

**The camera does not display pictures recorded with other cameras:** Pictures recorded with other makes of camera may not be displayed correctly.

---

**Some photos are not displayed during playback:** Select **All** for **Playback folder**.

---

**“Tall” (portrait) orientation photos are displayed in “wide” (landscape) orientation:**

- Select **On** for **Rotate tall** in the playback menu.
  - The photos are displayed in image review.
  - The camera was pointed up or down when photo was taken.
-

---

**Pictures cannot be deleted:** The pictures are protected. Remove protection.

**Pictures cannot be retouched:** The picture cannot be edited with this camera.

**The camera displays a message stating that the folder contains no images:** Select **All** for **Playback folder**.

**Pictures cannot be printed:** NEF (RAW) and TIFF photos cannot be printed by direct USB connection. Transfer the photos to a computer and print them using Capture NX-D. NEF (RAW) photos can be saved in JPEG format using the **NEF (RAW) processing** option in the retouch menu.

**Pictures are not displayed on HDMI devices:** Confirm that an HDMI cable (available separately) is connected.

**Output to HDMI devices does not function as expected:**

- Check that the HDMI cable is correctly connected.
- Select **Off** for **HDMI > Advanced > External recording control** in the setup menu.
- Check again after selecting **Reset all settings** in the setup menu.

**The Image Dust Off option in Capture NX-D does not have desired effect:** Image sensor cleaning changes the position of dust on the image sensor. Dust off reference data recorded before image sensor cleaning is performed cannot be used with photographs taken after image sensor cleaning is performed; similarly, dust off reference data recorded after image sensor cleaning is performed cannot be used with photographs taken before image sensor cleaning is performed.

**Computers do not display NEF (RAW) images the same way as the camera does:** Third-party software does not display effects of Picture Controls, Active D-Lighting, vignette control, or the like. Use Capture NX-D or ViewNX-i.

**Pictures cannot be transferred to a computer:** The computer operating system is not compatible with the camera or image transfer software. Use a card reader or card slot to copy the pictures to a computer.

---

## **Bluetooth and Wi-Fi (Wireless Networks)**

---

**Smart devices do not display the camera SSID (network name):**

- Confirm that **Disable** is selected for **Airplane mode** in the camera setup menu.
  - Confirm that **Enable** is selected for **Connect to smart device > Pairing (Bluetooth) > Bluetooth connection** in the camera setup menu.
  - Try turning the smart device Wi-Fi off and then on again.
- 

**The camera cannot connect to wireless printers and other wireless devices:** This camera can connect only to computers and smart devices.

---

## **Miscellaneous**

---

**The date of recording is not correct:** The camera clock is less accurate than most watches and household clocks. Check the clock regularly against more accurate timepieces and reset as necessary.

---

**Some menu items cannot be selected:** Some options are not available at certain combinations of settings or when no memory card is inserted.



---

## Indicators and Error Messages

This section lists the indicators and error messages that appear in the control panel and camera display.

### Indicators

The following indicators appear in the control panel and/or camera display:

Indicator		Problem	Solution
Camera display	Control panel		
		Low battery.	Ready a fully-charged spare battery.
	 (flashes)	Battery exhausted.	Recharge or replace battery.
		Battery info unavailable.	Battery cannot be used. Contact Nikon-authorized service representative.
		Battery not supported.	Replace with Nikon battery.
		Battery temperature high.	Remove battery and wait for it to cool.
	F---	Lens is not correctly attached.	Ensure that the lens is correctly attached and that retractable lenses are extended. This indicator is also displayed when a non-CPU lens is attached via a mount adapter, but in this case no action need be taken.
	<b>Bulb</b> (flashes)	<b>Bulb</b> selected in mode <b>S</b> .	Change shutter speed or select mode <b>M</b> .
	<b>Time</b> (flashes)	<b>Time</b> selected in mode <b>S</b> .	
	<b>Busy</b> (flashes)	Processing in progress.	Wait until processing is complete.



Indicator		Problem	Solution
Camera display	Control panel		
⚡ (flashes)	—	Flash has fired at full power; photo may be underexposed.	Check photo in display; if underexposed, adjust settings and try again.
(Exposure indicators and shutter speed or aperture display flash)		Subject too bright; photo will be overexposed.	<ul style="list-style-type: none"> <li>• Decrease ISO sensitivity.</li> <li>• Use optional ND filter. In mode: <b>S</b> Increase shutter speed <b>A</b> Choose a smaller aperture (higher f-number)</li> </ul>
		Subject too dark; photo will be underexposed.	<ul style="list-style-type: none"> <li>• Increase ISO sensitivity.</li> <li>• Use optional flash. In mode: <b>S</b> Lower shutter speed <b>A</b> Choose larger aperture (lower f-number)</li> </ul>
<b>Full</b> (flashes)		Memory insufficient to record further pictures at current settings, or camera has run out of file or folder numbers.	<ul style="list-style-type: none"> <li>• Reduce quality or size.</li> <li>• Delete pictures after copying important images to computer or other device.</li> <li>• Insert new memory card.</li> </ul>
<b>Err</b> (flashes)		Camera malfunction.	Release shutter. If error persists or appears frequently, consult Nikon-authorized service representative.

## Error Messages

Error messages in the camera display are sometimes accompanied by indicators in the control panel.

Message	Control panel	Problem	Solution
No memory card.	[–E–]	Camera cannot detect memory card.	Turn camera off and confirm that card is correctly inserted.
Cannot access this memory card. Insert another card.	Card, Err (flashes)	Error accessing memory card.	<ul style="list-style-type: none"><li>• Use Nikon-approved card.</li><li>• If error persists after card has been repeatedly ejected and reinserted, card may be damaged. Contact retailer or Nikon-authorized service representative.</li></ul>
		Unable to create new folder.	Delete files or insert new memory card after copying important pictures to computer or other device.
This card is not formatted. Format the card.	For (flashes)	Memory card has not been formatted for use in camera.	Format memory card or insert new memory card.
Unable to start live view. Please wait.	—	The internal temperature of the camera is high.	Wait for the internal circuits to cool before resuming shooting.
Folder contains no images.	—	No viewable pictures on memory card.	Insert memory card containing viewable pictures.
		No viewable pictures in folder(s) selected for playback.	Use <b>Playback folder</b> item in playback menu to select folder containing viewable pictures.

Message	Control panel	Problem	Solution
<b>Cannot display this file.</b>	—	File was edited on computer or does not comply with DCF standards, or file is corrupt.	File cannot be viewed on camera.
<b>Cannot select this file.</b>	—	Selected picture cannot be retouched.	Pictures created with other devices cannot be retouched.
<b>This movie cannot be edited.</b>	—	Selected movie cannot be edited.	<ul style="list-style-type: none"> <li>• Movies created with other devices cannot be edited.</li> <li>• Movies must be at least two seconds long.</li> </ul>
<b>Check printer.</b>	—	Printer error.	Check printer. To resume, select <b>Continue</b> (if available)*.
<b>Check paper.</b>	—	Paper in printer is not of selected size.	Insert paper of correct size and select <b>Continue</b> *.
<b>Paper jam.</b>	—	Paper is jammed in printer.	Clear jam and select <b>Continue</b> *.
<b>Out of paper.</b>	—	Printer is out of paper.	Insert paper of selected size and select <b>Continue</b> *.
<b>Check ink supply.</b>	—	Ink error.	Check ink. To resume, select <b>Continue</b> *.
<b>Out of ink.</b>	—	Printer is out of ink.	Replace ink and select <b>Continue</b> *.

\* See printer manual for more information.



# Technical Notes

Read this chapter for information on the camera display, compatible accessories, cleaning and storing the camera, and device specifications.

## The Camera Display and Control Panel

Refer to this section for information on the indicators in the camera display (monitor and viewfinder) and control panel. For illustrative purposes, the displays are shown with all indicators lit.

### The Monitor: Photo Mode

The following indicators appear in the monitor in photo mode.

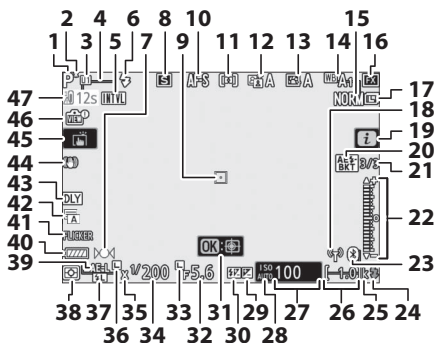

1	Shooting mode .....	72	6	Flash mode.....	110
2	Flexible program indicator .....	73	7	Focus indicator .....	62
3	User setting mode .....	77	8	Release mode .....	87, 114
4	AF-area brackets .....	54	9	Focus point.....	43, 54
5	Interval timer indicator .....	134	10	Focus mode.....	52, 133, 139
	"Clock not set" indicator .....	40			
	"No memory card" indicator .....	32, 35			

<b>11</b>	AF-area mode .....	54, 133, 139	<b>25</b>	“k” (appears when memory remains for over 1000 exposures) .....	34
<b>12</b>	Active D-Lighting .....	113, 131, 138	<b>26</b>	Number of exposures remaining .....	34, 236
<b>13</b>	Picture Control .....	97, 130, 137	<b>27</b>	ISO sensitivity .....	82
<b>14</b>	White balance .....	64, 101, 129, 136	<b>28</b>	ISO sensitivity indicator .....	82
<b>15</b>	Image quality .....	107, 128		Auto ISO sensitivity indicator .....	84
<b>16</b>	Image area .....	122, 127, 135	<b>29</b>	Exposure compensation indicator .....	85
<b>17</b>	Image size.....	109, 128	<b>30</b>	Flash compensation indicator....	132
<b>18</b>	Wi-Fi connection indicator .....	112	<b>31</b>	Subject tracking.....	59
<b>19</b>	 icon.....	13, 21	<b>32</b>	Aperture .....	74
<b>20</b>	Exposure and flash bracketing indicator .....	133	<b>33</b>	Aperture lock icon.....	148
	WB bracketing indicator .....	133	<b>34</b>	Shutter speed.....	73, 75
	ADL bracketing indicator.....	133	<b>35</b>	Flash sync indicator .....	146
	HDR indicator .....	133	<b>36</b>	Shutter speed lock icon .....	148
	Multiple exposure indicator.....	133	<b>37</b>	FV lock indicator .....	184
<b>21</b>	Number of shots remaining in exposure and flash bracketing sequence.....	133	<b>38</b>	Metering.....	111, 132, 139
	Number of shots remaining in white balance bracketing sequence.....	133	<b>39</b>	Autoexposure (AE) lock.....	92
	Number of shots remaining in ADL bracketing sequence.....	133	<b>40</b>	Battery indicator.....	34
	HDR exposure differential .....	133	<b>41</b>	Flicker detection .....	132
	Number of exposures (multiple exposure) .....	133	<b>42</b>	Shutter type.....	144
<b>22</b>	Exposure indicator .....	76		Silent photography .....	68
	Exposure compensation display .....	85	<b>43</b>	Exposure delay mode.....	144
	Bracketing progress indicator: Exposure and flash bracketing.....	133	<b>44</b>	Vibration reduction indicator.....	115, 133
<b>23</b>	Bluetooth connection indicator .....	154	<b>45</b>	Touch shooting .....	10, 60
	Airplane mode .....	154	<b>46</b>	Live view preview indicator.....	145
<b>24</b>	Flash-ready indicator .....	185	<b>47</b>	Temperature warning .....	173

### **Temperature Warnings**

If the camera temperature becomes elevated, a temperature warning will be displayed together with a count-down timer (the timer turns red when the thirty second mark is reached). In some cases, the timer may be displayed immediately after the camera is turned on. When the timer reaches zero, the shooting display will turn off automatically to protect the camera's internal circuits.

## ■ The Information Display

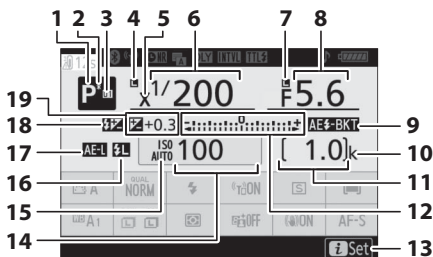

<b>1</b> Shooting mode .....72	<b>12</b> Exposure indicator .....76
<b>2</b> Flexible program indicator .....73	Exposure compensation display .....85
<b>3</b> User setting mode .....77	Bracketing progress indicator: Exposure and flash bracketing ..... 133
<b>4</b> Shutter speed lock icon ..... 148	WB bracketing..... 133
<b>5</b> Flash sync indicator..... 146	ADL bracketing ..... 133
<b>6</b> Shutter speed .....73, 75	<b>13</b> <b>i</b> icon ..... 13, 21
<b>7</b> Aperture lock icon ..... 148	<b>14</b> ISO sensitivity .....82
<b>8</b> Aperture.....74	<b>15</b> ISO sensitivity indicator .....82
<b>9</b> Exposure and flash bracketing indicator ..... 133	Auto ISO sensitivity indicator ....84
WB bracketing indicator ..... 133	<b>16</b> FV lock indicator ..... 184
ADL bracketing indicator ..... 133	<b>17</b> Autoexposure (AE) lock.....92
HDR indicator ..... 133	<b>18</b> Flash compensation indicator.... 132
Multiple exposure indicator..... 133	<b>19</b> Exposure compensation indicator .....85
<b>10</b> “k” (appears when memory remains for over 1000 exposures) .....34	Exposure compensation value .....85
<b>11</b> Number of exposures remaining .....34, 236	



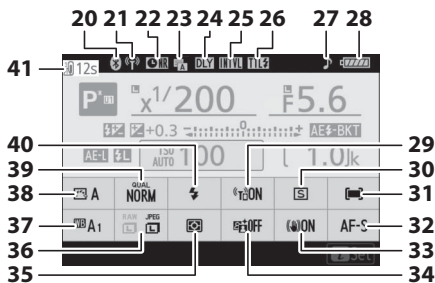

<b>20</b>	Bluetooth connection indicator ..... 154	<b>29</b>	Built-in Wi-Fi ..... 112, 154
<b>21</b>	Wi-Fi connection indicator ..... 112	<b>30</b>	Release mode ..... 87, 114
<b>22</b>	Long exposure noise reduction indicator ..... 131	<b>31</b>	AF-area mode ..... 54, 133, 139
<b>23</b>	Shutter type ..... 144	<b>32</b>	Focus mode ..... 52, 133, 139
	Silent photography ..... 68	<b>33</b>	Vibration reduction ..... 115, 133
<b>24</b>	Exposure delay mode ..... 144	<b>34</b>	Active D-Lighting ..... 113, 131, 138
<b>25</b>	Interval timer indicator ..... 134	<b>35</b>	Metering ..... 111, 132, 139
	“Clock not set” indicator ..... 40	<b>36</b>	Image size ..... 109, 128
<b>26</b>	Flash control mode ..... 132	<b>37</b>	White balance ..... 64, 101, 129, 136
<b>27</b>	“Beep” indicator ..... 152	<b>38</b>	Picture Control ..... 97, 130, 137
<b>28</b>	Battery indicator ..... 34	<b>39</b>	Image quality ..... 107, 128
		<b>40</b>	Flash mode ..... 110
		<b>41</b>	Temperature warning ..... 173

## The Monitor: Movie Mode

The following indicators appear in the monitor in movie mode.

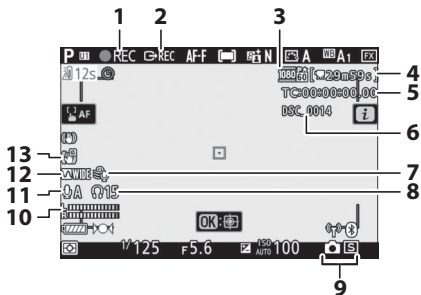

1	Recording indicator .....	45	7	Wind noise reduction .....	140
	"No movie" indicator .....	46	8	Headphone volume .....	140
2	External recording control .....	153	9	Release mode (still photography) .....	87
3	Frame size and rate/image quality .....	119, 135, 136	10	Sound level .....	121
4	Time remaining .....	45	11	Microphone sensitivity ....	121, 140
5	Time code .....	140	12	Frequency response .....	140
6	File name .....	135	13	Electronic VR indicator .....	123, 140

## The Viewfinder: Photo Mode

The following indicators appear in the viewfinder in photo mode.

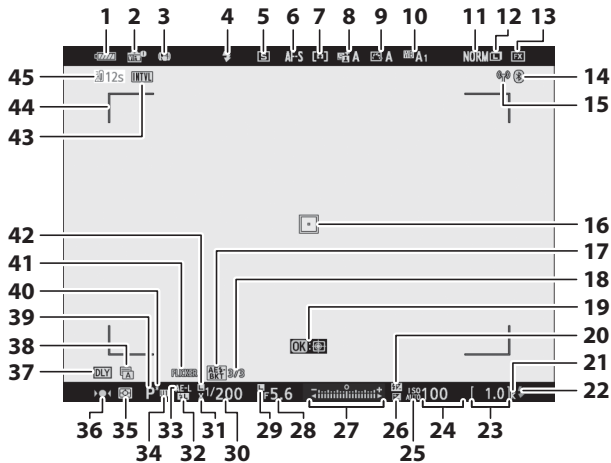

<b>1</b> Battery indicator .....	34	<b>12</b> Image size.....	109, 128
<b>2</b> Live view preview indicator .....	145	<b>13</b> Image area .....	122, 127, 135
<b>3</b> Vibration reduction indicator .....	115, 133	<b>14</b> Bluetooth connection indicator.....	154
<b>4</b> Flash mode .....	110	Airplane mode .....	154
<b>5</b> Release mode .....	87, 114	<b>15</b> Wi-Fi connection indicator.....	112
<b>6</b> Focus mode .....	52, 133, 139	<b>16</b> Focus point.....	43, 54
<b>7</b> AF-area mode .....	54, 133, 139	<b>17</b> Exposure and flash bracketing indicator.....	133
<b>8</b> Active D-Lighting indicator .....	113, 131, 138	WB bracketing indicator .....	133
<b>9</b> Picture Control indicator .....	97, 130, 137	ADL bracketing indicator.....	133
<b>10</b> White balance.....	64, 101, 129, 136	HDR indicator .....	133
<b>11</b> Image quality.....	107, 128	Multiple exposure indicator.....	133

18	Number of shots remaining in exposure and flash bracketing sequence.....	133	28	Aperture .....	74
	Number of shots remaining in white balance bracketing sequence.....	133	29	Aperture lock icon.....	148
	Number of shots remaining in ADL bracketing sequence.....	133	30	Shutter speed.....	73, 75
	HDR exposure differential .....	133	31	Flash sync indicator .....	146
	Number of exposures (multiple exposure) .....	133	32	FV lock indicator .....	184
19	Subject tracking.....	59	33	Autoexposure (AE) lock.....	92
20	Flash compensation indicator ...	132	34	User setting mode.....	77
21	"k" (appears when memory remains for over 1000 exposures).....	34	35	Metering.....	111, 132, 139
22	Flash-ready indicator .....	185	36	Focus indicator.....	62
23	Number of exposures remaining .....	34, 236	37	Exposure delay mode.....	144
24	ISO sensitivity .....	82	38	Shutter type.....	144
25	ISO sensitivity indicator .....	82		Silent photography .....	68
	Auto ISO sensitivity indicator .....	84	39	Shooting mode .....	72
26	Exposure compensation indicator .....	85	40	Flexible program indicator.....	73
27	Exposure indicator .....	76	41	Flicker detection .....	132
	Exposure compensation display .....	85	42	Shutter speed lock icon .....	148
	Bracketing progress indicator: Exposure and flash bracketing.....	133	43	Interval timer indicator .....	134
				"Clock not set" indicator .....	40
				"No memory card" indicator.....	32, 35
			44	AF-area brackets.....	54
			45	Temperature warning .....	173

## The Viewfinder: Movie Mode

The following indicators appear in the viewfinder in movie mode.

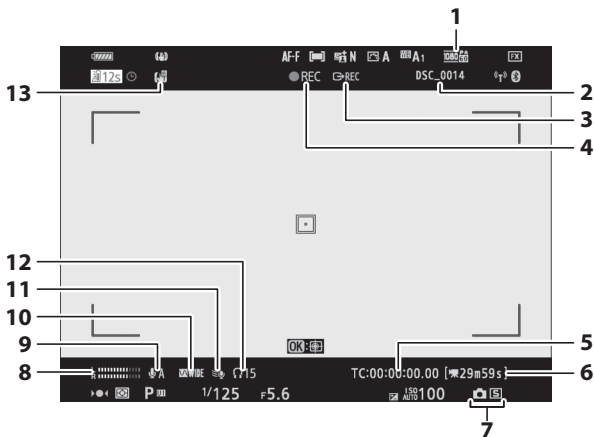

1	Frame size and rate/image quality..... 119, 135, 136	7	Release mode (still photography)..... 87
2	File name ..... 135	8	Sound level ..... 121
3	External recording control..... 153	9	Microphone sensitivity..... 121, 140
4	Recording indicator..... 45	10	Frequency response..... 140
	"No movie" indicator..... 46	11	Wind noise reduction ..... 140
5	Time code ..... 140	12	Headphone volume ..... 140
6	Time remaining ..... 45	13	Electronic VR indicator ..... 123, 140

## The Control Panel

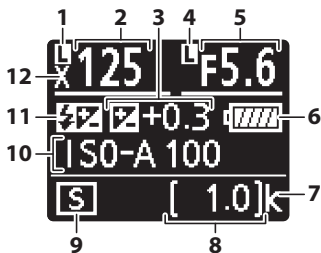

<table border="0"> <tr> <td style="background-color: #444; color: white; padding: 2px;">1</td> <td>Shutter-speed lock icon ..... 148</td> </tr> <tr> <td style="background-color: #444; color: white; padding: 2px;">2</td> <td>Shutter speed .....73, 75</td> </tr> <tr> <td style="background-color: #444; color: white; padding: 2px;">3</td> <td>Exposure compensation indicator .....85</td> </tr> <tr> <td></td> <td>Exposure compensation value .....85</td> </tr> <tr> <td style="background-color: #444; color: white; padding: 2px;">4</td> <td>Aperture lock icon ..... 148</td> </tr> <tr> <td style="background-color: #444; color: white; padding: 2px;">5</td> <td>Aperture.....74</td> </tr> <tr> <td style="background-color: #444; color: white; padding: 2px;">6</td> <td>Battery indicator .....34</td> </tr> <tr> <td style="background-color: #444; color: white; padding: 2px;">7</td> <td>"k" (appears when memory remains for over 1000 exposures) .....34</td> </tr> </table>	1	Shutter-speed lock icon ..... 148	2	Shutter speed .....73, 75	3	Exposure compensation indicator .....85		Exposure compensation value .....85	4	Aperture lock icon ..... 148	5	Aperture.....74	6	Battery indicator .....34	7	"k" (appears when memory remains for over 1000 exposures) .....34	<table border="0"> <tr> <td style="background-color: #444; color: white; padding: 2px;">8</td> <td>Number of exposures remaining .....34, 236</td> </tr> <tr> <td style="background-color: #444; color: white; padding: 2px;">9</td> <td>Release mode.....87</td> </tr> <tr> <td style="background-color: #444; color: white; padding: 2px;">10</td> <td>ISO sensitivity .....82</td> </tr> <tr> <td style="background-color: #444; color: white; padding: 2px;">11</td> <td>Flash compensation indicator.... 132</td> </tr> <tr> <td></td> <td>"Flash off" icon..... 110</td> </tr> <tr> <td style="background-color: #444; color: white; padding: 2px;">12</td> <td>Flash sync indicator ..... 146</td> </tr> </table>	8	Number of exposures remaining .....34, 236	9	Release mode.....87	10	ISO sensitivity .....82	11	Flash compensation indicator.... 132		"Flash off" icon..... 110	12	Flash sync indicator ..... 146
1	Shutter-speed lock icon ..... 148																												
2	Shutter speed .....73, 75																												
3	Exposure compensation indicator .....85																												
	Exposure compensation value .....85																												
4	Aperture lock icon ..... 148																												
5	Aperture.....74																												
6	Battery indicator .....34																												
7	"k" (appears when memory remains for over 1000 exposures) .....34																												
8	Number of exposures remaining .....34, 236																												
9	Release mode.....87																												
10	ISO sensitivity .....82																												
11	Flash compensation indicator.... 132																												
	"Flash off" icon..... 110																												
12	Flash sync indicator ..... 146																												

## The Nikon Creative Lighting System

Nikon's advanced Creative Lighting System (CLS) offers improved communication between the camera and compatible flash units for improved flash photography.

### CLS-Compatible Flash Units



The following features are available with CLS-compatible flash units:

		SB-5000	SB-800	SB-900	SB-910	SB-700	SB-600	SB-500	SU-800	SB-R200	SB-400	SB-300
Single flash	i-TTL	i-TTL balanced fill flash <sup>1</sup>	✓	✓	✓	✓	✓	✓	—	—	✓	✓
		Standard i-TTL fill flash	✓ <sup>2</sup>	✓ <sup>2</sup>	✓	✓ <sup>2</sup>	✓	—	—	✓	✓	
	 A	Auto aperture	✓	✓ <sup>3</sup>	—	—	—	—	—	—	—	—
	A	Non-TTL auto	—	✓ <sup>3</sup>	—	—	—	—	—	—	—	—
	GN	Distance-priority manual	✓	✓	✓	—	—	—	—	—	—	—
	M	Manual	✓	✓	✓	✓	✓ <sup>4</sup>	—	—	✓ <sup>4</sup>	✓ <sup>4</sup>	
	RPT	Repeating flash	✓	✓	—	—	—	—	—	—	—	





#### Flash Photography

Flash photography cannot be combined with some camera features, including:

- Silent photography
- Movie recording
- HDR (high dynamic range)
- High-speed continuous (extended)

		SB-5000	SB-800	SB-900	SB-910	SB-700	SB-600	SB-500	SU-800	SB-R200	SB-400	SB-300
Optical Advanced Wireless Lighting	Master	Remote flash control	✓	✓	✓	—	✓ <sup>4</sup>	✓	—	—	—	—
		<b>i-TTL</b> i-TTL	✓	✓	✓	—	✓ <sup>4</sup>	—	—	—	—	—
		<b>[A:B]</b> Quick wireless flash control	✓	—	✓	—	—	—	✓ <sup>5</sup>	—	—	—
		 <b>A</b> Auto aperture	✓	✓	—	—	—	—	—	—	—	—
		<b>A</b> Non-TTL auto	—	—	—	—	—	—	—	—	—	—
		<b>M</b> Manual	✓	✓	✓	—	✓ <sup>4</sup>	—	—	—	—	—
		<b>RPT</b> Repeating flash	✓	✓	—	—	—	—	—	—	—	—
	Remote	<b>i-TTL</b> i-TTL	✓	✓	✓	✓	✓	—	✓	—	—	—
		<b>[A:B]</b> Quick wireless flash control	✓	✓	✓	✓	✓	—	✓	—	—	
		 <b>A/A</b> Auto aperture/ Non-TTL auto	✓ <sup>6</sup>	✓ <sup>6</sup>	—	—	—	—	—	—	—	—
		<b>M</b> Manual	✓	✓	✓	✓	✓	—	✓	—	—	
		<b>RPT</b> Repeating flash	✓	✓	✓	✓	✓	—	—	—	—	
	Radio-controlled Advanced Wireless Lighting		✓ <sup>7</sup>	—	—	—	—	—	—	—	—	—
	Color information communication (flash)		✓	✓	✓	✓	✓	—	—	—	✓	✓
Color information communication (LED light)		—	—	—	—	—	✓	—	—	—	—	
Auto FP High-Speed Sync <sup>8</sup>		✓	✓	✓	✓	✓	✓	✓	✓	—	—	
FV lock <sup>9</sup>		✓	✓	✓	✓	✓	✓	✓	✓	✓	✓	
Red-eye reduction		✓	✓	✓	✓	✓	✓	—	—	✓	—	
Camera modeling illumination		✓	✓	✓	✓	✓	✓	✓	✓	—	—	
Unified flash control		✓	—	—	—	—	—	✓	—	—	✓	
Camera flash unit firmware update		✓	✓ <sup>10</sup>	—	✓	—	—	✓	—	—	—	✓



- 1 Not available with spot metering.
- 2 Can also be selected with flash unit.
- 3  **A/A** mode selection performed on flash unit using custom settings.
- 4 Can only be selected using the camera **Flash control** option.
- 5 Available only during close-up photography.
- 6 Choice of  **A** and **A** depends on the option selected with the master flash.
- 7 Supports the same features as remote flash units with optical AWL.
- 8 Available only in **i-TTL**, , **A**, **GN**, and **M** flash-control modes.
- 9 Available only in i-TTL flash control mode or when the flash is set to emit monitor pre-flashes in  **A** or **A** flash control mode.
- 10 Firmware updates for the SB-910 and SB-900 can be performed from the camera.

## **The SU-800 Wireless Speedlight Commander**

When mounted on a CLS-compatible camera, the SU-800 can be used as a commander for SB-5000, SB-910, SB-900, SB-800, SB-700, SB-600, SB-500, or SB-R200 flash units in up to three groups. The SU-800 itself is not equipped with a flash.

### **Modeling Illumination**

Pressing the control to which **Preview** has been assigned using Custom Setting f2 (**Custom control assignment**) causes CLS-compatible flash units to emit a modeling flash. This feature can be used with Advanced Wireless Lighting to preview the total lighting effect achieved with multiple flash units; the effect is best viewed by looking directly at the subject rather than at the camera display. Modeling illumination can be turned off using Custom Setting e5 (**Modeling flash**).

### **Studio Strobe Lighting**

To adjust the color and brightness of the view through the lens so that shots are easier to frame, select **Off** for Custom Setting d8 (**Apply settings to live view**).

### ✓ Flash Compensation

In i-TTL and auto aperture (⊗A) flash control modes, the flash compensation selected with the optional flash unit or the camera **Flash control** option is added to the flash compensation selected with the **Flash compensation** option in the photo shooting menu.

### ✓ Other Flash Units

The following flash units can be used in non-TTL auto and manual modes.

Flash unit		SB-80DX, SB-28DX, SB-28, SB-26, SB-25, SB-24	SB-50DX, SB-23, SB-29, SB-21B, SB-29S	SB-30, SB-27 <sup>1</sup> , SB-22S, SB-22, SB-20, SB-16B, SB-15
Flash mode				
<b>A</b>	Non-TTL auto	✓	—	✓
<b>M</b>	Manual	✓	✓	✓
	Repeating flash	✓	—	—
<b>REAR</b>	Rear-curtain sync <sup>2</sup>	✓	✓	✓

1 Flash mode is automatically set to TTL and shutter-release is disabled. Set flash unit to **A** (non-TTL auto flash).

2 Available when camera is used to select flash mode.

### ✓ Using FV Lock with Optional Flash Units

FV lock is available with optional flash units in TTL and (where supported) monitor pre-flash ⊗A and monitor pre-flash **A** flash control modes (see the manual provided with the flash unit for more information). Note that when Advanced Wireless Lighting is used to control remote flash units, you will need to set the flash control mode for the master or at least one remote group to **TTL**, ⊗A, or **A**. The area metered for FV lock is as follows:

Flash unit	Flash mode	Metered area
Stand-alone flash unit	i-TTL	6-mm circle in center of frame
	⊗A	Area metered by flash exposure meter
Used with other flash units (Advanced Wireless Lighting)	i-TTL	Entire frame
	⊗A	Area metered by flash exposure meter
	<b>A</b>	

### ✔ Notes on Optional Flash Units

Refer to the flash unit manual for detailed instructions. If the unit supports CLS, refer to the section on CLS-compatible digital SLR cameras. Note that this camera is not included in the “digital SLR” category in the SB-80DX, SB-28DX, and SB-50DX manuals.

i-TTL flash control can be used at ISO sensitivities between 64 and 12800 (Z 7) or between 100 and 12800 (Z 6). At values over 12800, the desired results may not be achieved at some ranges or aperture settings. If the flash-ready indicator (⚡) flashes for about three seconds after a photograph is taken in i-TTL or non-TTL auto mode, the flash has fired at full power and the photograph may be underexposed (CLS-compatible flash units only).

When an SC-series 17, 28, or 29 sync cable is used for off-camera flash photography, correct exposure may not be achieved in i-TTL mode. We recommend that you select standard i-TTL fill-flash. Take a test shot and view the results in the camera display.

In i-TTL, use the flash panel or bounce adapter provided with the flash unit. Do not use other panels such as diffusion panels, as this may produce incorrect exposure.

In mode P, the maximum aperture (minimum f-number) is limited according to ISO sensitivity, as shown below:

Maximum aperture at ISO equivalent of:								
64	100	200	400	800	1600	3200	6400	12800
3.5	4	5	5.6	7.1	8	10	11	13

If the maximum aperture of the lens is smaller than given above, the maximum value for aperture will be the maximum aperture of the lens.

AF-assist illumination is provided by the camera, not the flash unit; the SB-5000, SB-910, SB-900, SB-800, SB-700, SB-600, SB-500, and SB-400 do, however, provide red-eye reduction.

Noise in the form of lines may appear in flash photographs taken with an SD-9 or SD-8A high-performance battery pack attached directly to the camera. Reduce ISO sensitivity or increase the distance between the camera and the power pack.

## Other Accessories

A variety of accessories are available for your Nikon camera.

<b>Power sources</b>	<ul style="list-style-type: none"><li>• <b>EN-EL15b Rechargeable Li-ion Battery:</b> Additional EN-EL15b batteries are available from local retailers and Nikon service representatives. EN-EL15a/EN-EL15 batteries can also be used, but note that you may not be able to take as many pictures on a single charge (□ 238).</li><li>• <b>MH-25a Battery Charger:</b> The MH-25a can be used to recharge EN-EL15b batteries. MH-25 battery chargers can also be used.</li><li>• <b>MB-N10 Battery Pack:</b> A battery pack for Nikon mirrorless cameras. Attached to the camera, it allows the use of two EN-EL15b rechargeable Li-ion batteries as a power source.</li><li>• <b>EH-7P Charging AC Adapter:</b> The EH-7P can be used to charge EN-EL15b batteries inserted in the camera (the battery only charges when the camera is off). It cannot be used to charge EN-EL15a/EN-EL15 batteries.</li><li>• <b>EP-5B Power Connector, EH-5c and EH-5b AC Adapters:</b> These accessories can be used to power the camera for extended periods. The EP-5B is required to connect the camera to the EH-5c/EH-5b; see “Attaching a Power Connector and AC Adapter” (□ 191) for details.</li></ul>
<b>Filters</b>	<ul style="list-style-type: none"><li>• Neutral Color (NC) filters can be used to protect the lens.</li><li>• To prevent ghosting, avoid using filters when the subject is framed against a bright light, or when a bright light source is in the frame.</li><li>• Center-weighted metering is recommended if matrix metering fails to produce the desired results for filters with exposure factors (filter factors) over 1× (Y44, Y48, Y52, O56, R60, X0, X1, C-PL, ND2S, ND4, ND4S, ND8, ND8S, ND400, A2, A12, B2, B8, B12). See the filter manual for details.</li><li>• Filters intended for special-effects photography may interfere with autofocus or the in-focus indicator (●).</li></ul>
<b>Mount adapters</b>	<b>FTZ Mount Adapter</b> (□ 228)

<b>Remote cords</b>	<b>MC-DC2 Remote Cord</b> (length 1 m/3 ft 4 in.): When connected to the camera accessory terminal, the MC-DC2 can be used to release the shutter remotely.
<b>GPS units</b>	<b>GP-1/GP-1A GPS Unit:</b> When connected to the camera accessory terminal, existing GP-1/GP-1A units can be used to record the current latitude, longitude, altitude, and UTC (Universal Coordinated Time) with pictures taken with the camera. Note that production of GP-1/GP-1A units has ended.
<b>USB cables</b>	<ul style="list-style-type: none"> <li>• <b>UC-E24 USB cable:</b> A USB cable with a type C connector for connection to the camera and a type A connector for connection to the USB device.</li> <li>• <b>UC-E25 USB cable:</b> A USB cable with two type C connectors.</li> </ul>
<b>HDMI cables</b>	<b>HC-E1 HDMI Cable:</b> An HDMI cable with a type C connector for connection to the camera and a type A connector for connection to HDMI devices.
<b>Hot shoe adapters</b>	<b>AS-15 Sync Terminal Adapter:</b> Mount the AS-15 on the camera hot shoe to connect studio strobe lights or other flash equipment via a sync terminal.
<b>Accessory shoe covers</b>	<b>BS-1 Accessory Shoe Cover:</b> A cover protecting the accessory shoe when no flash unit is attached.
<b>Body caps</b>	<b>BF-N1 Body Cap:</b> The body cap prevents dust entering the camera when a lens is not in place.
<b>Wireless transmitters</b>	<p><b>WT-7 Wireless Transmitter:</b> Use the WT-7 to upload pictures over a wireless network, to control the camera from a computer running Camera Control Pro 2 (available separately), or to take and browse pictures remotely from a computer or smart device.</p> <p><b>Note:</b> A wireless network and some basic network knowledge is required when using a wireless transmitter. Be sure to update the wireless transmitter software to the latest version.</p>

**Wireless remote controllers**

- **WR-R10 Wireless Remote Controller/WR-T10 Wireless Remote Controller:** When a WR-R10 wireless remote controller is attached to the accessory terminal, the camera can be controlled wirelessly using a WR-T10 wireless remote controller (when connecting the WR-R10, be sure the cover for the accessory terminal and the USB and HDMI connectors is fully open). The WR-R10 can also be used to control radio-controlled flash units. For synchronized release involving more than one camera, ready multiple cameras with paired WR-R10 units attached.
- **WR-1 Wireless Remote Controller:** WR-1 units are used with WR-R10 or WR-T10 wireless remote controllers or with other WR-1 remote controllers, with the WR-1 units functioning as either transmitters or receivers. As a transmitter, the WR-1 can be used to control the camera and take pictures via signals transmitted to a receiver (a WR-R10 or a second WR-1) connected to the camera accessory terminal, while as a receiver it receives remote commands from a WR-T10 or a separate WR-1 transmitter.

**Note:** Be sure the firmware for the WR-R10 and WR-1 has been updated to the latest version (WR-R10 firmware version 3.0 or later and WR-1 firmware version 1.0.1 or later). For information on firmware updates, see the Nikon website for your area. Consult a Nikon-authorized service representative when updating the firmware for the WR-R10 from versions prior to version 2.0 to version 3.0 or later.

**Viewfinder eyepiece accessories**

**DK-29 Rubber Eyecup:** The DK-29 makes the image in the viewfinder easier to see, preventing eye fatigue.

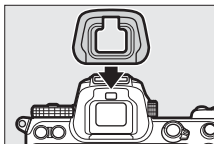
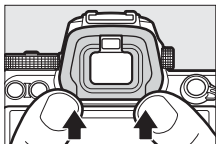

<b>Microphones</b>	<ul style="list-style-type: none"> <li>• <b>ME-1 Stereo Microphone:</b> Connect the ME-1 to the camera microphone jack to record stereo sound and reduce the chance of picking up equipment noise (such as the sounds produced by the lens during autofocus).</li> <li>• <b>ME-W1 Wireless Microphone:</b> Use this wireless Bluetooth microphone for off-camera recording.</li> </ul>
<b>Software</b>	<p><b>Camera Control Pro 2:</b> Control the camera remotely from a computer and save photographs directly to the computer hard disk. When Camera Control Pro 2 is used to capture photographs directly to the computer, a PC connection indicator (<b>PC</b>) will appear in the control panel.</p> <p><b>Note:</b> Use the latest versions of Nikon software; see the Nikon website for your region for the latest information on supported operating systems. At default settings, Nikon Message Center 2 will periodically check for updates to Nikon software and firmware while you are logged in to an account on the computer and the computer is connected to the Internet. A message is automatically displayed when an update is found.</p>

Availability may vary with country or region. See our website or brochures for the latest information.

#### **✓ Attaching and Removing the Accessory Shoe Cover**

The BS-1 accessory shoe cover slides into the accessory shoe as shown. To remove the cover, hold the camera firmly, press the cover down with a thumb and slide it in the direction shown.

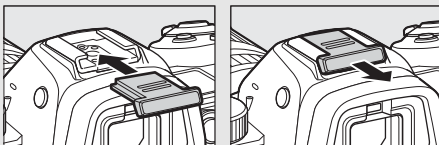

### ✔ The HDMI/USB Cable Clip

To prevent accidental disconnection, attach the supplied clip to HDMI cables or to the supplied USB cable as shown (the illustration shows the USB cable; note that the clip may not fit all third-party HDMI cables). Keep the monitor in the storage position when using the cable clip.

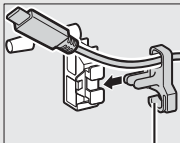
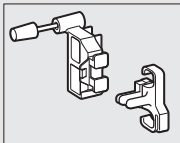

*HDMI cable goes here*

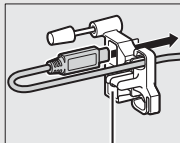

*HDMI cable goes here*

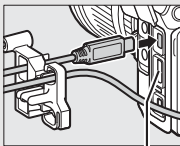

*HDMI cable goes here*

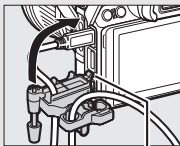

*Insert tab into matching slot on camera and attach cable clip*

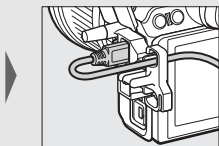
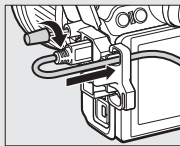

*USB cable*

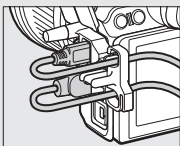

*HDMI cable and USB cable used simultaneously*



## **Attaching a Power Connector and AC Adapter**

Turn the camera off before attaching an optional power connector and AC adapter.

### **1 Ready the camera.**

Open the battery-chamber cover (1) and power connector cover (2) covers.

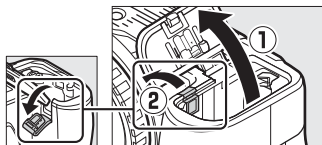

### **2 Insert the EP-5B power connector.**

Be sure to insert the connector in the orientation shown, using the connector to keep the orange battery latch pressed to one side. The latch locks the connector in place when the connector is fully inserted.

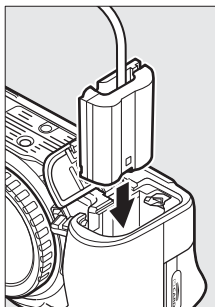

### **3 Close the battery-chamber cover.**

Position the power connector cable so that it passes through the power connector slot and close the battery-chamber cover.

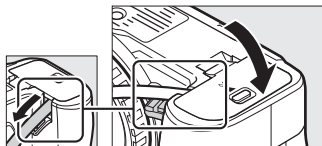

---

## 4 Connect the EH-5c/EH-5b AC adapter.

Connect the AC adapter power cable to the AC socket on the AC adapter (③) and the power cable to the DC socket (④). A  icon is displayed when the camera is powered by the AC adapter and power connector.

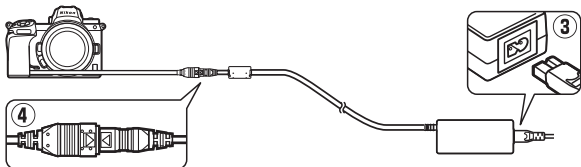

## Caring for the Camera

Learn how to store, clean, and care for your camera.

### Storage

When the camera will not be used for an extended period, remove the battery and store it in a cool, dry area with the terminal cover in place. To prevent mold or mildew, store the camera in a dry, well-ventilated area. Do not store your camera with naphtha or camphor moth balls or in locations that:

- are poorly ventilated or subject to humidities of over 60%,
- are next to equipment that produces strong electromagnetic fields, such as televisions or radios, or
- are exposed to temperatures above 50 °C (122 °F) or below -10 °C (14 °F)

### Cleaning

*Do not use alcohol, thinner, or other volatile chemicals.*

- **Camera body:** Use a blower to remove dust and lint, then wipe gently with a soft, dry cloth. After using the camera at the beach or seaside, wipe off sand or salt with a cloth lightly dampened in distilled water and dry thoroughly. **Important:** *Dust or other foreign matter inside the camera may cause damage not covered under warranty.*
- **Lenses, viewfinder:** Glass surfaces are easily damaged. Remove dust and lint with a blower. If using an aerosol blower, keep the can vertical to prevent the discharge of liquid. To remove fingerprints and other stains, apply a small amount of lens cleaner to a soft cloth and clean with care.
- **Monitor:** Remove dust and lint with a blower. When removing fingerprints and other stains, wipe the surface lightly with a soft cloth or chamois leather. Do not apply pressure, as this could result in damage or malfunction.

## Image Sensor Cleaning

If you suspect that dirt or dust on the image sensor is appearing in photographs, you can clean the sensor using the **Clean image sensor** option in the setup menu. The sensor can be cleaned at any time using the **Clean now** option, or cleaning can be performed automatically when the camera is turned off. If image sensor cleaning fails to resolve the problem, contact a Nikon-authorized service representative.

### ■ ■ “Clean Now”

Holding the camera base down, select **Clean image sensor** in the setup menu, then highlight **Clean now** and press **OK**. The camera will check and clean the image sensor. No other operations can be performed until cleaning is complete; do not remove or disconnect the power source until cleaning ends and the setup menu is displayed.

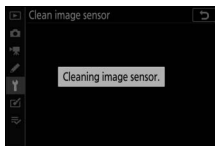
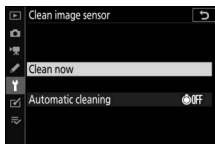
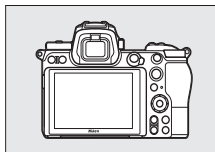

### **✔ Image Sensor Cleaning**

Using camera controls during shutdown interrupts image sensor cleaning.

If image sensor cleaning is performed several times in succession, image sensor cleaning may be temporarily disabled to protect the camera's internal circuitry. Cleaning can be performed again after a short wait.

## ■ “Automatic Cleaning”

Choose from the following options:

 <b>Clean at shutdown</b>	The image sensor is automatically cleaned during shutdown each time the camera is turned off.
<b>Cleaning off</b>	Automatic image sensor cleaning off.

- 1 Select Automatic Cleaning.**  
Display the **Clean image sensor** menu as described in “Clean Now” (194). Highlight **Automatic Cleaning** and press .

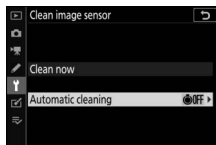

- 2 Select an option.**  
Highlight an option and press .

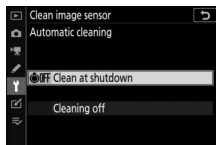

## **Manual Cleaning**

If foreign matter cannot be removed from the image sensor using image sensor cleaning, the sensor can be cleaned manually as described below. Note, however, that the sensor is extremely delicate and easily damaged; we recommend that manual cleaning be performed only by a Nikon-authorized service representative.

---

### **1 Remove the lens.**

Turn the camera off and remove the lens or body cap.

---

### **2 Examine the image sensor.**

Holding the camera so that light falls on the image sensor, examine the sensor for dust or lint. If no foreign objects are present, proceed to Step 4.

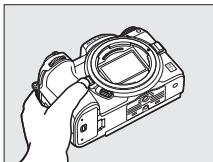

### **3 Clean the sensor.**

Remove any dust and lint from the sensor with a blower. Do not use a blower-brush, as the bristles could damage the sensor. Dirt that cannot be removed with a blower can only be removed by Nikon-authorized service personnel. Under no circumstances should you touch or wipe the sensor.

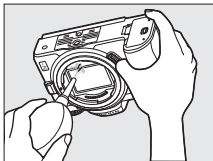

### **4 Replace the lens or body cap.**

### **✔ Foreign Matter on the Image Sensor**

Foreign matter entering the camera when lenses or body caps are removed or exchanged (or in rare circumstances lubricant or fine particles from the camera itself) may adhere to the image sensor, where it may appear in photographs taken under certain conditions. To protect the camera when no lens is in place, be sure to replace the body cap provided with the camera, being careful to first remove all dust and other foreign matter that may be adhering to the camera mount, lens mount, and body cap. Avoid attaching the body cap or exchanging lenses in dusty environments.

Should foreign matter find its way onto the image sensor, use the image sensor cleaning option as described in “Image Sensor Cleaning” (□ 194). If the problem persists, clean the sensor manually (□ 197) or have the sensor cleaned by authorized Nikon service personnel. Photographs affected by the presence of foreign matter on the sensor can be retouched using the clean image options available in some imaging applications.

### **✔ Servicing the Camera and Accessories**

The camera is a precision device and requires regular servicing. Nikon recommends that the camera be inspected by the original retailer or a Nikon-authorized service representative once every one to two years, and that it be serviced once every three to five years (note that fees apply to these services). Frequent inspection and servicing are particularly recommended if the camera is used professionally. Any accessories regularly used with the camera, such as lenses or optional flash units, should be included when the camera is inspected or serviced.



## Caring for the Camera and Battery: Cautions

**Do not drop:** The product may malfunction if subjected to strong shocks or vibration.

**Keep dry:** This product is not waterproof, and may malfunction if immersed in water or exposed to high levels of humidity. Rusting of the internal mechanism can cause irreparable damage.

**Avoid sudden changes in temperature:** Sudden changes in temperature, such as those that occur when entering or leaving a heated building on a cold day, can cause condensation inside the device. To prevent condensation, place the device in a carrying case or plastic bag before exposing it to sudden changes in temperature.

**Keep away from strong magnetic fields:** Do not use or store this device in the vicinity of equipment that generates strong electromagnetic radiation or magnetic fields. Static charges or the magnetic fields produced by equipment such as radio transmitters could interfere with the display, damage data stored on the memory card, or affect the product's internal circuitry.

**Do not leave the lens pointed at the sun:** Do not leave the lens pointed at the sun or other strong light source for an extended period. Intense light may cause the image sensor to deteriorate or produce a white blur effect in photographs.

**Lasers and other bright light sources:** Do not direct lasers or other extremely bright light sources toward the lens, as this could damage the camera's image sensor.

**Turn the product off before removing or disconnecting the power source:** Do not unplug the product or remove the battery while the product is on or while images are being recorded or deleted. Forcibly cutting power in these circumstances could result in loss of data or in damage to product memory or internal circuitry. To prevent an accidental interruption of power, avoid carrying the product from one location to another while an AC adapter is connected.

**Cleaning:** When cleaning the camera body, use a blower to gently remove dust and lint, then wipe gently with a soft, dry cloth. After using the camera at the beach or seaside, wipe off any sand or salt using a cloth lightly dampened in pure water and then dry the camera thoroughly. In rare instances, static electricity may cause the LCD displays to light up or go dark. This does not indicate a malfunction, and the display will soon return to normal.

Lenses, viewfinders, and other glass elements are easily damaged. Dust and lint should be gently removed with a blower. When using an aerosol blower, keep the can vertical to prevent discharge of liquid. To remove fingerprints and other stains from glass surfaces, apply a small amount of lens cleaner to a soft cloth and wipe the glass carefully.

**Do not touch the image sensor:** Under no circumstances should you exert pressure on the image sensor, poke it with cleaning tools, or subject it to powerful air currents from a blower. These actions could scratch or otherwise damage the sensor. For information on cleaning the image sensor, see “Image Sensor Cleaning” (□ 194).

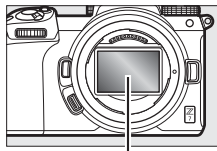

*Image sensor*

**Lens contacts:** Keep the lens contacts clean and be careful not to touch them with your fingers or with tools or other objects.

**Storage:** To prevent mold or mildew, store the camera in a dry, well-ventilated area. If you are using an AC adapter, unplug the adapter to prevent fire. If the product will not be used for an extended period, remove the battery to prevent leakage and store the camera in a plastic bag containing a desiccant. Do not, however, store the camera case in a plastic bag, as this may cause the material to deteriorate. Note that desiccant gradually loses its capacity to absorb moisture and should be replaced at regular intervals.

To prevent mold or mildew, take the camera out of storage at least once a month. Turn the camera on and release the shutter a few times before putting it away.

Store the battery in a cool, dry place. Replace the terminal cover before putting the battery away.

**Notes on the monitor and viewfinder:** These displays are constructed with extremely high precision; at least 99.99% of pixels are effective, with no more than 0.01% being missing or defective. Hence while these displays may contain pixels that are always lit (white, red, blue, or green) or always off (black), this is not a malfunction and has no effect on images recorded with the device.

Images in the monitor may be difficult to see in a bright light. Do not apply pressure to the monitor, as this could cause damage or malfunction. Dust or lint can be removed with a blower. Stains can be removed by wiping lightly with a soft cloth or chamois leather. Should the monitor break, care should be taken to avoid injury from broken glass and to prevent liquid crystal from the monitor touching the skin or entering the eyes and mouth.

Should you feel unwell or experience any of the following symptoms while framing shots in the viewfinder, discontinue use until your condition improves: nausea, eye pain, eye fatigue, dizziness, headache, stiffness in your neck or shoulders, carsickness, or loss of hand-eye coordination. The same applies should you start to feel unwell when watching the shooting display flicker rapidly on and off during burst photography.

Noise in the form of lines may in rare cases appear in pictures that include bright lights or back-lit subjects.

**The battery and charger:** Batteries may leak or explode if improperly handled. Observe the following precautions when handling batteries and chargers:

- Use only batteries approved for use in this equipment.
- Do not expose the battery to flame or excessive heat.
- Keep the battery terminals clean.
- Turn the product off before replacing the battery.
- The battery may become hot while in use. Observe caution when handling the battery immediately after use.

- Remove the battery from the camera or charger when not in use and replace the terminal cover. These devices draw minute amounts of charge even when off and could draw the battery down to the point that it will no longer function. If the battery will not be used for some time, insert it in the camera and run it flat before removing it from the camera for storage. The battery should be stored in a cool location with an ambient temperature of 15 °C to 25 °C (59 °F to 77 °F; avoid hot or extremely cold locations). Repeat this process at least once every six months.
- Turning the camera on or off repeatedly when the battery is fully discharged will shorten battery life. Batteries that have been fully discharged must be charged before use.
- The internal temperature of the battery may rise while the battery is in use. Attempting to charge the battery while the internal temperature is elevated will impair battery performance, and the battery may not charge or charge only partially. Wait for the battery to cool before charging.
- Charge the battery indoors at ambient temperatures of 5 °C to 35 °C (41 °F to 95 °F). Do not use the battery at ambient temperatures below 0 °C (32 °F) or above 40 °C (104 °F); failure to observe this precaution could damage the battery or impair its performance. Capacity may be reduced and charging times increase at battery temperatures from 0 °C (32 °F) to 15 °C (59 °F) and from 45 °C (113 °F) to 60 °C (140 °F). The battery will not charge if its temperature is below 0 °C (32 °F) or above 60 °C (140 °F).
- If the **CHARGE** lamp flashes quickly (about eight times a second) during charging, confirm that the temperature is in the correct range and then unplug the charger and remove and reinsert the battery. If the problem persists, cease use immediately and take battery and charger to your retailer or a Nikon-authorized service representative.
- Do not move the charger or touch the battery during charging. Failure to observe this precaution could in very rare instances result in the charger showing that charging is complete when the battery is only partially charged. Remove and reinsert the battery to begin charging again.

- Battery capacity may temporarily drop if the battery is charged at low temperatures or used at a temperature below the temperature at which it was charged. If the battery is charged at a temperature below 5 °C (41 °F), the battery life indicator in the **Battery info** display may show a temporary decrease.
- Continuing to charge the battery after it is fully charged can impair battery performance.
- A marked drop in the time a fully charged battery retains its charge when used at room temperature indicates that it requires replacement. Purchase a new EN-EL15b battery.
- The supplied power cable and AC wall adapter are for use with the MH-25a only. Use the charger with compatible batteries only. Unplug when not in use.
- Do not short the charger terminals. Failure to observe this precaution could result in overheating and damage to the charger.
- Charge the battery before use. When taking photographs on important occasions, ready a spare battery and keep it fully charged. Depending on your location, it may be difficult to purchase replacement batteries on short notice. Note that on cold days, the capacity of batteries tends to decrease. Be sure the battery is fully charged before taking photographs outside in cold weather. Keep a spare battery in a warm place and exchange the two as necessary. Once warmed, a cold battery may recover some of its charge.
- Recycle rechargeable batteries in accord with local regulations, being sure to first insulate the terminals with tape.

**The charging AC adapter:** Observe the precautions below when using the charging AC adapter.

- Do not move the camera during charging. Failure to observe this precaution could in very rare instances result in the camera showing that charging is complete when the battery is only partially charged. Disconnect and reconnect the adapter to begin charging again.
- Do not short the adapter terminals. Failure to observe this precaution could result in overheating and damage to the adapter.
- Unplug the adapter when it is not in use.

# Specifications

## Nikon Z 7/Z 6 Digital Camera

Type	
Type	Digital camera with support for interchangeable lenses
Lens mount	Nikon Z mount
Lens	
Compatible lenses	<ul style="list-style-type: none"><li>• Z mount NIKKOR lenses</li><li>• F mount NIKKOR lenses with mount adapter; restrictions may apply</li></ul>
Effective pixels	
Effective pixels	<ul style="list-style-type: none"><li>• <b>Z7</b>: 45.7 million</li><li>• <b>Z6</b>: 24.5 million</li></ul>
Image sensor	
Image sensor	35.9 × 23.9 mm CMOS sensor (Nikon FX format)
Total pixels	<ul style="list-style-type: none"><li>• <b>Z7</b>: 46.89 million</li><li>• <b>Z6</b>: 25.28 million</li></ul>
Dust-Reduction System	Image Dust Off reference data (requires Capture NX-D); image sensor cleaning
Storage	
Image size (pixels)	<ul style="list-style-type: none"><li>• <b>Z7</b>:<ul style="list-style-type: none"><li>- <b>FX (36×24) image area</b><ul style="list-style-type: none"><li>8256 × 5504 (Large: 45.4 M)</li><li>6192 × 4128 (Medium: 25.6 M)</li><li>4128 × 2752 (Small: 11.4 M)</li></ul></li><li>- <b>DX (24×16) image area</b><ul style="list-style-type: none"><li>5408 × 3600 (Large: 19.5 M)</li><li>4048 × 2696 (Medium: 10.9 M)</li><li>2704 × 1800 (Small: 4.9 M)</li></ul></li><li>- <b>5 : 4 (30×24) image area</b><ul style="list-style-type: none"><li>6880 × 5504 (Large: 37.9 M)</li><li>5152 × 4120 (Medium: 21.2 M)</li><li>3440 × 2752 (Small: 9.5 M)</li></ul></li></ul></li></ul>

## Storage

### Image size (pixels)

#### - **1 : 1 (24×24) image area**

5504 × 5504 (Large: 30.3 M)

4128 × 4128 (Medium: 17.0 M)

2752 × 2752 (Small: 7.6 M)

#### - **16 : 9 (36×20) image area**

8256 × 4640 (Large: 38.3 M)

6192 × 3480 (Medium: 21.5 M)

4128 × 2320 (Small: 9.6 M)

#### - **Photographs taken during movie recording at a frame size of 3840 × 2160:** 3840 × 2160

#### - **Photographs taken during movie recording at other frame sizes:** 1920 × 1080

#### • **Z 6:**

#### - **FX (36×24) image area**

6048 × 4024 (Large: 24.3 M)

4528 × 3016 (Medium: 13.7 M)

3024 × 2016 (Small: 6.1 M)

#### - **DX (24×16) image area**

3936 × 2624 (Large: 10.3 M)

2944 × 1968 (Medium: 5.8 M)

1968 × 1312 (Small: 2.6 M)

#### - **1 : 1 (24×24) image area**

4016 × 4016 (Large: 16.1 M)

3008 × 3008 (Medium: 9.0 M)

2000 × 2000 (Small: 4.0 M)

#### - **16 : 9 (36×20) image area**

6048 × 3400 (Large: 20.6 M)

4528 × 2544 (Medium: 11.5 M)

3024 × 1696 (Small: 5.1 M)

#### - **Photographs taken during movie recording at a frame size of 3840 × 2160:** 3840 × 2160

#### - **Photographs taken during movie recording at other frame sizes:** 1920 × 1080

Storage	
<b>File format</b>	<ul style="list-style-type: none"> <li>• <b>NEF (RAW)</b>: 12 or 14 bit (lossless compressed, compressed, or uncompressed); large, medium, and small available (medium and small images are recorded at a bit depth of 12 bits using lossless compression)</li> <li>• <b>TIFF (RGB)</b></li> <li>• <b>JPEG</b>: JPEG-Baseline compliant with fine (approx. 1 : 4), normal (approx. 1 : 8), or basic (approx. 1 : 16) compression; optimal quality compression available</li> <li>• <b>NEF (RAW)+JPEG</b>: Single photograph recorded in both NEF (RAW) and JPEG formats</li> </ul>
<b>Picture Control System</b>	Auto, Standard, Neutral, Vivid, Monochrome, Portrait, Landscape, Flat, Creative Picture Controls (Dream, Morning, Pop, Sunday, Somber, Dramatic, Silence, Bleached, Melancholic, Pure, Denim, Toy, Sepia, Blue, Red, Pink, Charcoal, Graphite, Binary, Carbon); selected Picture Control can be modified; storage for custom Picture Controls
<b>Media</b>	XQD and CFexpress (Type B) memory cards
<b>File system</b>	DCF 2.0, Exif 2.31, PictBridge
Viewfinder	
<b>Viewfinder</b>	1.27-cm/0.5-in. approx. 3690k-dot (Quad VGA) OLED electronic viewfinder with color balance and auto and 11-level manual brightness controls
<b>Frame coverage</b>	Approx. 100% horizontal and 100% vertical
<b>Magnification</b>	Approx. 0.8× (50 mm lens at infinity, $-1.0 \text{ m}^{-1}$ )
<b>Eyepoint</b>	21 mm ( $-1.0 \text{ m}^{-1}$ ; from center surface of viewfinder eyepiece lens)
<b>Diopter adjustment</b>	$-4 - +2 \text{ m}^{-1}$
<b>Eye sensor</b>	Automatically switches between monitor and viewfinder displays





<b>Monitor</b>	
<b>Monitor</b>	8-cm/3.2-in., approx. 2100k-dot tilting TFT touch-sensitive LCD with 170° viewing angle, approximately 100% frame coverage, and color balance and 11-level manual brightness controls
<b>Shutter</b>	
<b>Type</b>	Electronically-controlled vertical-travel focal-plane mechanical shutter; electronic front-curtain shutter; electronic shutter
<b>Speed</b>	$\frac{1}{8000}$ – 30 s in steps of $\frac{1}{3}$ or $\frac{1}{2}$ EV, bulb, time, X200
<b>Flash sync speed</b>	X = $\frac{1}{200}$ s; synchronizes with shutter at $\frac{1}{200}$ s or slower; Auto FP High-Speed sync supported
<b>Release</b>	
<b>Release mode</b>	Single frame, low-speed continuous, high-speed continuous, high-speed continuous (extended), self-timer
<b>Approximate maximum frame advance rate (measured under Nikon-specified test conditions)</b>	<ul style="list-style-type: none"> <li>• <b>Z7:</b> <ul style="list-style-type: none"> <li>- <b>Low-speed continuous:</b> 1–5 fps</li> <li>- <b>High-speed continuous:</b> 5.5 fps (14-bit NEF/RAW: 5 fps)</li> <li>- <b>High-speed continuous (extended):</b> 9 fps (14-bit NEF/RAW: 8 fps)</li> </ul> </li> <li>• <b>Z6:</b> <ul style="list-style-type: none"> <li>- <b>Low-speed continuous:</b> 1–5 fps</li> <li>- <b>High-speed continuous:</b> 5.5 fps</li> <li>- <b>High-speed continuous (extended):</b> 12 fps (14-bit NEF/RAW: 9 fps)</li> </ul> </li> </ul>
<b>Self-timer</b>	2 s, 5 s, 10 s, 20 s; 1–9 exposures at intervals of 0.5, 1, 2, or 3 s

Exposure	
<b>Metering system</b>	TTL metering using camera image sensor
<b>Metering mode</b>	<ul style="list-style-type: none"> <li>• <b>Matrix metering</b></li> <li>• <b>Center-weighted metering:</b> Weight of 75% given to 12 mm circle in center of frame; weighting can instead be based on average of entire frame</li> <li>• <b>Spot metering:</b> Meters 4 mm circle (about 1.5% of frame) centered on selected focus point</li> <li>• <b>Highlight-weighted metering</b></li> </ul>
<b>Range (ISO 100, f/2.0 lens, 20 °C/68 °F)</b>	<ul style="list-style-type: none"> <li>• <b>Z7:</b> -3 – +17 EV</li> <li>• <b>Z6:</b> -4 – +17 EV</li> </ul>
<b>Mode</b>	Auto (AUTO); programmed auto with flexible program ( <b>P</b> ); shutter-priority auto ( <b>S</b> ); aperture-priority auto ( <b>A</b> ); manual ( <b>M</b> ); user settings ( <b>U1, U2, U3</b> )
<b>Exposure compensation</b>	-5 – +5 EV in increments of 1/3 or 1/2 EV available in modes <b>P, S, A, and M</b>
<b>Exposure lock</b>	Luminosity locked at detected value
<b>ISO sensitivity (Recommended Exposure Index)</b>	<ul style="list-style-type: none"> <li>• <b>Z7:</b> ISO 64 – 25600 in steps of 1/3 or 1/2 EV. Can also be set to approx. 0.3, 0.5, 0.7, or 1 EV (ISO 32 equivalent) below ISO 64 or to approx. 0.3, 0.5, 0.7, 1, or 2 EV (ISO 102400 equivalent) above ISO 25600; auto ISO sensitivity control available</li> <li>• <b>Z6:</b> ISO 100 – 51200 in steps of 1/3 or 1/2 EV. Can also be set to approx. 0.3, 0.5, 0.7, or 1 EV (ISO 50 equivalent) below ISO 100 or to approx. 0.3, 0.5, 0.7, 1, or 2 EV (ISO 204800 equivalent) above ISO 51200; auto ISO sensitivity control available</li> </ul>
<b>Active D-Lighting</b>	Can be selected from <b>Auto, Extra high, High, Normal, Low, or Off</b>
<b>Multiple exposure</b>	Add, average, lighten, darken
<b>Other options</b>	HDR (high dynamic range), photo mode flicker reduction

Focus	
<b>Autofocus</b>	Hybrid phase-detection/contrast AF with AF assist
<b>Detection range (single-servo AF, photo shooting mode, ISO 100, f/2.0 lens, 20 °C/68 °F)</b>	<ul style="list-style-type: none"> <li>• <b>Z7:</b> -2 – +19 EV (with low-light AF: -4 – +19 EV)</li> <li>• <b>Z6:</b> -3.5 – +19 EV (with low-light AF: -6 – +19 EV)</li> </ul>
<b>Lens servo</b>	<ul style="list-style-type: none"> <li>• <b>Autofocus (AF):</b> Single-servo AF (AF-S); continuous-servo AF (AF-C); full-time AF (AF-F; available only in movie mode); predictive focus tracking</li> <li>• <b>Manual focus (M):</b> Electronic rangefinder can be used</li> </ul>
<b>Focus points (single-point AF, photo shooting mode, FX image area)</b>	<ul style="list-style-type: none"> <li>• <b>Z7:</b> 493</li> <li>• <b>Z6:</b> 273</li> </ul>
<b>AF-area mode</b>	Pinpoint, single-point, and dynamic-area AF (pinpoint and dynamic-area AF available in photo mode only); wide-area AF (S); wide-area AF (L); auto-area AF
<b>Focus lock</b>	Focus can be locked by pressing shutter-release button halfway (single-servo AF) or by pressing center of sub-selector
Vibration reduction (VR)	
<b>Camera VR</b>	5-axis image sensor shift
<b>Lens VR</b>	Lens shift (available with VR lenses)
Flash	
<b>Flash control</b>	<b>TTL:</b> i-TTL flash control; i-TTL balanced fill-flash is used with matrix, center-weighted, and highlight-weighted metering, standard i-TTL fill-flash with spot metering
<b>Flash mode</b>	Front-curtain sync, slow sync, rear-curtain sync, red-eye reduction, red-eye reduction with slow sync, off
<b>Flash compensation</b>	-3 – +1 EV in increments of 1/3 or 1/2 EV available in modes <b>P, S, A,</b> and <b>M</b>

Flash	
<b>Flash-ready indicator</b>	Lights when optional flash unit is fully charged; flashes as underexposure warning after flash is fired at full output
<b>Accessory shoe</b>	ISO 518 hot-shoe with sync and data contacts and safety lock
<b>Nikon Creative Lighting System (CLS)</b>	i-TTL flash control, radio-controlled Advanced Wireless Lighting, optical Advanced Wireless Lighting, modeling illumination, FV lock, Color Information Communication, Auto FP High-Speed Sync, unified flash control
White balance	
<b>White balance</b>	Auto (3 types), natural light auto, direct sunlight, cloudy, shade, incandescent, fluorescent (7 types), flash, choose color temperature (2500 K–10,000 K), preset manual (up to 6 values can be stored), all except choose color temperature with fine-tuning
Bracketing	
<b>Bracketing types</b>	Exposure, flash, white balance, and ADL
Movie	
<b>Metering system</b>	TTL metering using camera image sensor
<b>Metering mode</b>	Matrix, center-weighted, or highlight-weighted
<b>Frame size (pixels) and frame rate</b>	<ul style="list-style-type: none"> <li>• 3840 × 2160 (4K UHD); 30p (progressive), 25p, 24p</li> <li>• 1920 × 1080; 120p, 100p, 60p, 50p, 30p, 25p, 24p</li> <li>• 1920 × 1080 (slow-motion); 30p × 4, 25p × 4, 24p × 5</li> </ul> <p>Actual frame rates for 120p, 100p, 60p, 50p, 30p, 25p, and 24p are 119.88, 100, 59.94, 50, 29.97, 25, and 23.976 fps respectively; quality selection available at all sizes except 3840 × 2160, 1920 × 1080 120p/100p, and 1920 × 1080 slow-motion, when quality is fixed at ★ (high)</p>

Movie	
File format	MOV, MP4
Video compression	H.264/MPEG-4 Advanced Video Coding
Audio recording format	Linear PCM, AAC
Audio recording device	Built-in stereo or external microphone with attenuator option; sensitivity adjustable
Exposure compensation	-3 – +3 EV in increments of $\frac{1}{3}$ or $\frac{1}{2}$ EV available in modes <b>P</b> , <b>S</b> , <b>A</b> , and <b>M</b>
ISO sensitivity (Recommended Exposure Index)	<ul style="list-style-type: none"> <li>• <b>Z7:</b> <ul style="list-style-type: none"> <li>- : Auto ISO sensitivity control (ISO 64 to 25600)</li> <li>- <b>P, S, A:</b> Auto ISO sensitivity control (ISO 64 to Hi 2) with selectable upper limit</li> <li>- <b>M:</b> Auto ISO sensitivity control (ISO 64 to Hi 2) available with selectable upper limit; manual selection (ISO 64 to 25600 in steps of <math>\frac{1}{3}</math> or <math>\frac{1}{2}</math> EV) with additional options available equivalent to approximately 0.3, 0.5, 0.7, 1, or 2 EV (ISO 102400 equivalent) above ISO 25600</li> </ul> </li> <li>• <b>Z6:</b> <ul style="list-style-type: none"> <li>- : Auto ISO sensitivity control (ISO 100 to 51200)</li> <li>- <b>P, S, A:</b> Auto ISO sensitivity control (ISO 100 to Hi 2) with selectable upper limit</li> <li>- <b>M:</b> Auto ISO sensitivity control (ISO 100 to Hi 2) available with selectable upper limit; manual selection (ISO 100 to 51200 in steps of <math>\frac{1}{3}</math> or <math>\frac{1}{2}</math> EV) with additional options available equivalent to approximately 0.3, 0.5, 0.7, 1, or 2 EV (ISO 204800 equivalent) above ISO 51200</li> </ul> </li> </ul>
Active D-Lighting	Can be selected from <b>Same as photo settings</b> , <b>Extra high</b> , <b>High</b> , <b>Normal</b> , <b>Low</b> , or <b>Off</b>
Other options	Time-lapse movies, electronic vibration reduction, time codes, movie log output (N-Log)

Playback	
<b>Playback</b>	Full-frame and thumbnail (4, 9, or 72 images) playback with playback zoom, playback zoom cropping, movie playback, photo and/or movie slide shows, histogram display, highlights, photo information, location data display, picture rating, and auto image rotation
Interface	
<b>USB</b>	Type C connector (SuperSpeed USB); connection to built-in USB port is recommended
<b>HDMI output</b>	Type C HDMI connector
<b>Accessory terminal</b>	Can be used with MC-DC2 and other optional accessories
<b>Audio input</b>	Stereo mini-pin jack (3.5 mm diameter; plug-in power supported)
<b>Audio output</b>	Stereo mini-pin jack (3.5 mm diameter)
Wi-Fi/Bluetooth	
<b>Wi-Fi</b>	<ul style="list-style-type: none"> <li>• <b>Standards:</b> <ul style="list-style-type: none"> <li>- IEEE 802.11b/g/n/a/ac (U.S.A., Canada, Mexico)</li> <li>- IEEE 802.11b/g/n/a (other countries in the Americas)</li> </ul> </li> <li>• <b>Operating frequency:</b> <ul style="list-style-type: none"> <li>- 2412–2462 MHz (channel 11) and 5180–5825 MHz (U.S.A., Canada, Mexico)</li> <li>- 2412–2462 MHz (channel 11) and 5180–5805 MHz (other countries in the Americas)</li> </ul> </li> <li>• <b>Maximum output power (EIRP):</b> <ul style="list-style-type: none"> <li>- <b>Z7:</b> 2.4 GHz band: 7.0 dBm 5 GHz band: 12.1 dBm</li> <li>- <b>Z6:</b> 2.4 GHz band: 7.4 dBm 5 GHz band: 12.2 dBm</li> </ul> </li> <li>• <b>Authentication:</b> Open system, WPA2-PSK</li> </ul>

Wi-Fi/Bluetooth	
<b>Bluetooth</b>	<ul style="list-style-type: none"> <li>• <b>Communication protocols:</b> Bluetooth Specification Version 4.2</li> <li>• <b>Operating frequency:</b> Bluetooth: 2402–2480 MHz Bluetooth Low Energy: 2402–2480 MHz</li> <li>• <b>Maximum output power (EIRP):</b> <ul style="list-style-type: none"> <li>- <b>Z7:</b> Bluetooth: 1.5 dBm Bluetooth Low Energy: 0 dBm</li> <li>- <b>Z6:</b> Bluetooth: 1.9 dBm Bluetooth Low Energy: 0.4 dBm</li> </ul> </li> </ul>
<b>Range (line of sight)</b>	Approximately 10 m (32 ft) without interference; range may vary with signal strength and presence or absence of obstacles
Power source	
<b>Battery</b>	One EN-EL15b rechargeable Li-ion battery; EN-EL15a/EN-EL15 can also be used, but note that you may not be able to take as many pictures on a single charge and that charging AC adapter can be used to charge EN-EL15b batteries only
<b>Battery pack</b>	MB-N10 battery pack (available separately); takes two EN-EL15b * batteries * EN-EL15a/EN-EL15 batteries can be used in place of the EN-EL15b. The number of pictures that can be taken on a single charge (i.e., battery endurance) may however drop compared to the EN-EL15b.
<b>Charging AC adapter</b>	EH-7P charging AC adapter (supplied with the Z7 only)
<b>AC adapter</b>	EH-5c/EH-5b AC adapter (requires EP-5B power connector, which is available separately)
Tripod socket	
<b>Tripod socket</b>	¼ in. (ISO 1222)

Dimensions/weight	
<b>Dimensions (W × H × D)</b>	Approx. 134 × 100.5 × 67.5 mm (5.3 × 4 × 2.7 in.)
<b>Weight</b>	Approx. 675 g (1 lb. 7.9 oz.) with battery and memory card but without body cap; approx. 585 g/1 lb. 4.7 oz. (camera body only)
Operating environment	
<b>Temperature</b>	0 °C–40 °C (+32 °F–104 °F)
<b>Humidity</b>	85% or less (no condensation)

- Unless otherwise stated, all measurements are performed in conformity with Camera and Imaging Products Association (CIPA) standards or guidelines.
- All figures are for a camera with a fully-charged battery.
- The sample images displayed on the camera and the images and illustrations in the manuals are for expository purposes only.
- Nikon reserves the right to change the appearance and specifications of the hardware and software described in this manual at any time and without prior notice. Nikon will not be held liable for damages that may result from any mistakes that this manual may contain.

## ■ ■ MH-25a Battery Charger

<b>Rated input</b>	AC 100–240 V, 50/60 Hz, 0.23–0.12 A
<b>Rated output</b>	DC 8.4 V/1.2 A
<b>Supported batteries</b>	Nikon EN-EL15b rechargeable Li-ion batteries
<b>Charging time</b>	Approx. 2 hours and 35 minutes at an ambient temperature of 25 °C (77 °F) when no charge remains
<b>Operating temperature</b>	0 °C–40 °C (+32 °F–104 °F)
<b>Dimensions (W × H × D)</b>	Approx. 95 × 33.5 × 71 mm (3.7 × 1.3 × 2.8 in.), excluding projections
<b>Length of power cable</b>	Approx. 1.5 m (4.9 ft), if supplied
<b>Weight</b>	Approx. 115 g (4.1 oz), excluding supplied power connector (power cable or AC wall adapter)

The symbols on this product represent the following:

~ AC, --- DC, □ Class II equipment (The construction of the product is double-insulated.)



## ■ ■ EH-7P Charging AC Adapter (Supplied with the Z7 Only)

Rated input	AC 100–240 V, 50/60 Hz, MAX 0.5 A
Rated output	DC 5.0 V/3.0 A, 15.0 W
Supported batteries	Nikon EN-EL15b rechargeable Li-ion batteries
Operating temperature	0 °C–40 °C (+32 °F–104 °F)
Average active efficiency	81.80%
Efficiency at low load (10%)	72.50%
No-load power consumption	0.075 W
Dimensions (W × H × D)	Approx. 65.5 × 26.5 × 58.5 mm (2.6 × 1.1 × 2.4 in.), excluding plug adapter
Weight	Approx. 125 g (4.5 oz), excluding plug adapter

The EH-7P comes with a plug adapter attached in countries or regions where required; the shape of the plug adapter varies with the country of sale. Do not attempt to remove the plug adapter, as this could damage the product.

The symbols on this product represent the following:

~ AC, --- DC,  Class II equipment (The construction of the product is double-insulated.)

### ■ Notice for Customers in Europe Distributor (Importer for EU Countries) Nikon Europe B.V.

Tripolis 100, Burgerweeshuispad 101, 1076 ER Amsterdam, The Netherlands  
+31-20-7099-000

Commercial registration number: 34036589



## ■ ■ EN-EL15b Rechargeable Li-ion Battery

Type	Rechargeable lithium-ion battery
Rated capacity	7.0 V/1900 mAh
Operating temperature	0 °C–40 °C (+32 °F–104 °F)
Dimensions (W × H × D)	Approx. 40 × 56 × 20.5 mm (1.6 × 2.2 × 0.8 in.)
Weight	Approx. 80 g (2.9 oz), excluding terminal cover

Nikon reserves the right to change the appearance and specifications of the hardware and software described in this manual at any time and without prior notice. Nikon will not be held liable for damages that may result from any mistakes that this manual may contain.

## ✍ Disposing of Data Storage Devices

Please note that deleting images or formatting memory cards or other data storage devices does not completely erase the original image data. Deleted files can sometimes be recovered from discarded storage devices using commercially available software, potentially resulting in the malicious use of personal image data. Ensuring the privacy of such data is the user's responsibility.

Before discarding a data storage device or transferring ownership to another person, erase all data using commercial deletion software, or format the device and then completely refill it with images containing no private information (for example, pictures of empty sky). Care should be taken to avoid injury when physically destroying data storage devices.

Before discarding the camera or transferring ownership to another person, you should also use the **Reset all settings** option in the camera setup menu to delete network settings and other personal information.

## ✍ Supported Standards

- **DCF Version 2.0:** The Design Rule for Camera File System (DCF) is a standard widely used in the digital camera industry to ensure compatibility among different makes of camera.
- **Exif version 2.31:** The camera supports Exif (Exchangeable Image File Format for Digital Still Cameras) version 2.31, a standard in which information stored with photographs is used for optimal color reproduction when the images are output on Exif-compliant printers.
- **PictBridge:** A standard developed through cooperation with the digital camera and printer industries, allowing photographs to be output directly to a printer without first transferring them to a computer.
- **HDMI:** High-Definition Multimedia Interface is a standard for multimedia interfaces used in consumer electronics and AV devices capable of transmitting audiovisual data and control signals to HDMI-compliant devices via a single cable connection.

## Trademark Information

CFexpress is a trademark of the CompactFlash Association in the United States and other countries. NVM Express is a trademark of NVM Express Inc. in the United States and other countries. IOS is a trademark or registered trademark of Cisco Systems, Inc., in the United States and/or other countries and is used under license. Windows is either a registered trademark or a trademark of Microsoft Corporation in the United States and/or other countries. Mac, macOS, OS X, Apple®, App Store®, the Apple logos, iPhone®, iPad®, and iPod touch® are trademarks of Apple Inc. registered in the U.S. and/or other countries. Android, Google Play and the Google Play logo are trademarks of Google LLC. The Android robot is reproduced or modified from work created and shared by Google and used according to terms described in the Creative Commons 3.0 Attribution License. PictBridge is a trademark of the Camera and Imaging Products Association (CIPA). XQD is a trademark of Sony Corporation. HDMI, the HDMI logo and High-Definition Multimedia Interface are trademarks or registered trademarks of HDMI Licensing, LLC.

## **HDMI**

Wi-Fi and the Wi-Fi logo are trademarks or registered trademarks of the Wi-Fi Alliance. The Bluetooth® word mark and logos are registered trademarks owned by Bluetooth SIG, Inc. and any use of such marks by Nikon Corporation is under license.

All other trade names mentioned in this manual or the other documentation provided with your Nikon product are trademarks or registered trademarks of their respective holders.

Use of the Made for Apple badge means that an accessory has been designed to connect specifically to the Apple products identified in the badge, and has been certified by the developer to meet Apple performance standards. Apple is not responsible for the operation of this device or its compliance with safety and regulatory standards. Please note that the use of this accessory with an Apple product may affect wireless performance.

### **FreeType License (FreeType2)**

Portions of this software are copyright © 2012 The FreeType Project (<https://www.freetype.org>). All rights reserved.

### **MIT License (HarfBuzz)**

Portions of this software are copyright © 2018 The HarfBuzz Project (<https://www.freedesktop.org/wiki/Software/HarfBuzz>). All rights reserved.

### **Unicode® Character Database License (Unicode® Character Database)**

The programs for this camera include open-source Unicode® Character Database software. The license for this software can be viewed in the reference manuals for the following products under the heading “Unicode® Character Database License (Unicode® Character Database)”.  
[https://downloadcenter.nikonimglib.com/en/products/492/Z\\_7.html](https://downloadcenter.nikonimglib.com/en/products/492/Z_7.html)  
[https://downloadcenter.nikonimglib.com/en/products/493/Z\\_6.html](https://downloadcenter.nikonimglib.com/en/products/493/Z_6.html)

### **AVC Patent Portfolio License**

THIS PRODUCT IS LICENSED UNDER THE AVC PATENT PORTFOLIO LICENSE FOR THE PERSONAL AND NON-COMMERCIAL USE OF A CONSUMER TO (i) ENCODE VIDEO IN COMPLIANCE WITH THE AVC STANDARD (“AVC VIDEO”) AND/OR (ii) DECODE AVC VIDEO THAT WAS ENCODED BY A CONSUMER ENGAGED IN A PERSONAL AND NON-COMMERCIAL ACTIVITY AND/OR WAS OBTAINED FROM A VIDEO PROVIDER LICENSED TO PROVIDE AVC VIDEO. NO LICENSE IS GRANTED OR SHALL BE IMPLIED FOR ANY OTHER USE. ADDITIONAL INFORMATION MAY BE OBTAINED FROM MPEG LA, L.L.C. SEE <http://www.mpegla.com>

### **BSD License (NVM Express Driver)**

The license conditions for the open source software incorporated in the camera’s NVM Express driver can be viewed in the reference manuals for the following products under the heading “BSD License (NVM Express Driver)”.  
[https://downloadcenter.nikonimglib.com/en/products/492/Z\\_7.html](https://downloadcenter.nikonimglib.com/en/products/492/Z_7.html)  
[https://downloadcenter.nikonimglib.com/en/products/493/Z\\_6.html](https://downloadcenter.nikonimglib.com/en/products/493/Z_6.html)

# NIKKOR Z 24–70mm f/4 S Lens User's Manual

This section is included as a lens manual for purchasers of the NIKKOR Z 24–70mm f/4 S lens kit. Note that lens kits may not be available in some countries or regions.

## Using the Lens

### Parts of the Lens: Names and Functions

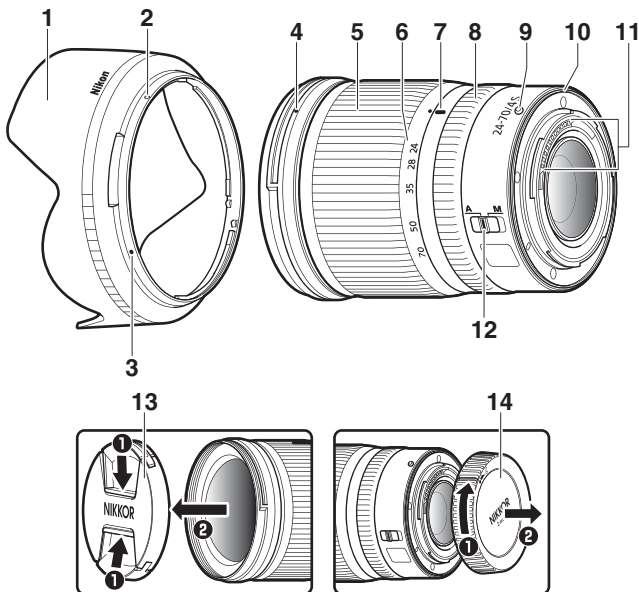

1 Lens hood	Lens hoods block stray light that would otherwise cause flare or ghosting. They also serve to protect the lens.
2 Lens hood lock mark	
3 Lens hood alignment mark	Use when attaching the lens hood.
4 Lens hood mounting mark	Use when attaching the lens hood.
5 Zoom ring	Rotate to zoom in or out. Be sure to extend the lens before use.
6 Focal length scale	Determine the approximate focal length when zooming the lens in or out.
7 Focal length mark	
8 Control ring	<ul style="list-style-type: none"> <li>• <b>Autofocus mode selected:</b> In autofocus mode, you can rotate this customizable ring to perform a function selected with the camera.</li> <li>• <b>Manual focus mode selected:</b> Rotate to focus.</li> </ul>
9 Lens mounting mark	Use when mounting the lens on the camera.
10 Rubber lens-mount gasket	—
11 CPU contacts	Used to transfer data to and from the camera.
12 Focus-mode switch	Choose <b>A</b> for autofocus, <b>M</b> for manual focus. Note that regardless of the setting chosen, focus must be adjusted manually when manual focus mode is selected using camera controls.
13 Front lens cap	—
14 Rear lens cap	—

## ■ ■ Attachment and Removal

### Attaching the Lens

---

- 1** Turn the camera off, remove the body cap, and detach the rear lens cap.
- 
- 2** Position the lens on the camera body, keeping the mounting mark on the lens aligned with the mounting mark on the camera body, and then rotate the lens counterclockwise until it clicks into place.

### Removing the Lens

---

- 1** Turn the camera off.
- 
- 2** Press and hold the lens release button while turning the lens clockwise.

## ■ ■ Before Use

The lens is retractable and must be extended before use. Rotate the zoom ring as shown until the lens clicks into the extended position. Pictures can only be taken when the focal length mark points to positions between 24 and 70 on the focal length scale.

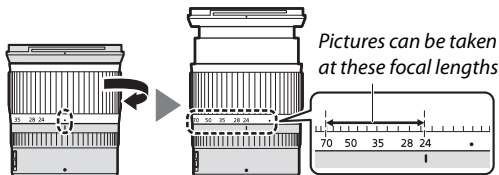

To retract the lens, rotate the zoom ring in the opposite direction, stopping when you reach the (●) position on the focal length scale.

If the camera is turned on with the lens retracted, a warning will be displayed. Extend the lens before use.



## ■■ Attaching and Removing the Lens Hood

Align the lens hood mounting mark (●) with the lens hood alignment mark (●) and then rotate the hood (②) until the ● mark is aligned with the lens hood lock mark (○).

To remove the hood, reverse the above steps.

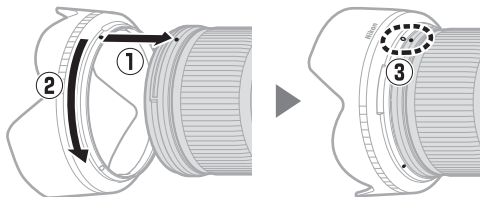

When attaching or removing the hood, hold it near the ● symbol on its base and avoid gripping it too tightly. The hood can be reversed and mounted on the lens when not in use.

## ■■ When the Lens Is Attached

The focus position may change if you turn the camera off and then on again after focusing. Refocus before shooting. If you have focused on a pre-selected location while waiting for your subject to appear, we recommend that you do not turn the camera off until the picture is taken.

## **Precautions for Use**

- Do not pick up or hold the lens or camera using only the lens hood.
- Keep the CPU contacts clean.
- Should the rubber lens-mount gasket be damaged, cease use immediately and take the lens to a Nikon-authorized service center for repair.
- Replace the front and rear lens caps when the lens is not in use.
- To protect the interior of the lens, store it out of direct sunlight.
- Keep the lens dry. Rusting of the internal mechanism can cause irreparable damage.
- Leaving the lens in extremely hot locations could damage or warp parts made from reinforced plastic.
- Rapid changes in temperature may cause damaging condensation inside and outside the lens. Before taking the lens from a warm to a cold environment or vice versa, place it in its case or a plastic bag to slow the change in temperature.
- We recommend that you place the lens in its case to protect it from scratches during transport.

## **Lens Care**

- Removing dust is normally sufficient to clean the glass surfaces of the lens.
- Smudges and fingerprints can be removed from fluorine-coated lens elements using a soft, clean cotton cloth or lens cleaning tissue; clean from the center outwards using a circular motion. To remove stubborn stains, wipe gently using a soft cloth lightly dampened with a small amount of distilled water, ethanol, or lens cleaner. Any drop-shaped marks left from this process on the water- and oil-repellent surface can subsequently be removed with a dry cloth.
- When cleaning lens elements that are not fluorine-coated, remove smudges and fingerprints using a soft, clean cotton cloth or lens cleaning tissue lightly dampened with a small amount of ethanol or lens cleaner. Wipe gently from the center outwards in a circular motion, taking care not to leave smears or touch the lens with your fingers.
- Never use organic solvents such as paint thinner or benzene to clean the lens.
- Neutral Color (NC) filters (available separately) and the like can be used to protect the front lens element.
- If the lens will not be used for an extended period, store it in a cool, dry location to prevent mold and rust. Do not store in direct sunlight or with naphtha or camphor moth balls.

## **Accessories**

### **■ Supplied Accessories**

- LC-72B 72 mm snap-on Front Lens Cap
- LF-N1 Rear Lens Cap
- HB-85 Bayonet Hood
- CL-C1 Lens Case

#### **☑ Using the Lens Case**

- The case is intended to protect the lens from scratches, not from falls or other physical shocks.
- The case is not water resistant.
- The material used in the case may fade, bleed, shrink, or change color when rubbed or wet.
- Remove dust with a soft brush.
- Water and stains can be removed from the surface with a soft, dry cloth. Do not use alcohol, benzene, thinner, or other volatile chemicals.
- Do not store in locations exposed to direct sunlight or high temperatures or humidity.
- Do not use the case to clean the monitor or lens elements.
- Be careful that the lens does not fall from the case during transport.

Material: Polyester

### **■ Compatible Accessories**

72 mm screw-on filters

#### **☑ Filters**

Use only one filter at a time. Remove the lens hood before attaching filters or rotating circular polarizing filters.

## Specifications

<b>Mount</b>	Nikon Z mount
<b>Focal length</b>	24 – 70 mm
<b>Maximum aperture</b>	f/4
<b>Lens construction</b>	14 elements in 11 groups (including 1 ED lens element, 1 aspherical ED element, 3 aspherical elements, elements with Nano Crystal Coat, and a fluorine-coated front lens element)
<b>Angle of view</b>	<ul style="list-style-type: none"><li>• <b>FX format:</b> 84° – 34° 20′</li><li>• <b>DX format:</b> 61° – 22° 50′</li></ul>
<b>Focal length scale</b>	Graduated in millimeters (24, 28, 35, 50, 70)
<b>Focusing system</b>	Internal focusing system
<b>Minimum focus distance</b>	0.3 m (0.99 ft) from focal plane at all zoom positions
<b>Diaphragm blades</b>	7 (rounded diaphragm opening)
<b>Aperture range</b>	f/4 – 22
<b>Filter-attachment size</b>	72 mm (P = 0.75 mm)
<b>Dimensions</b>	Approx. 77.5 mm maximum diameter × 88.5 mm (distance from camera lens mount flange when lens is retracted)
<b>Weight</b>	Approx. 500 g (1 lb 1.7 oz)

Nikon reserves the right to change the appearance, specifications, and performance of this product at any time and without prior notice.

## FTZ Mount Adapter User's Manual

This mount adapter allows Nikon F mount NIKKOR lenses to be mounted on Nikon Z mount mirrorless cameras. It cannot be mounted on F mount (Nikon digital SLR) or 1 mount cameras (Nikon 1 advanced cameras with interchangeable lenses) or used with 1 NIKKOR lenses. This section is included as a mount-adapter manual for purchasers of the mount-adapter kit. Note that mount-adapter kits may not be available in some countries or regions.

Note that depending on the lens, the adapter may limit autofocus or other camera features.

### **Compatible F Mount Lenses**

For information on lenses that can be mounted on the FTZ mount adapter for use with Z mount cameras, see *Compatible F Mount Lenses*, available from the Nikon Download Center:



<https://downloadcenter.nikonimglib.com/en/products/491/FTZ.html>

# The Mount Adapter

## Parts of the Adapter

Lens mount

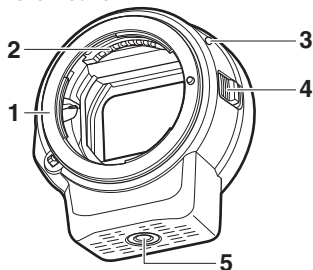

- 1 Nikon F mount (attaches to lens)
- 2 Lens signal contacts
- 3 Lens mounting mark
- 4 Lens release
- 5 Tripod socket

Camera mount

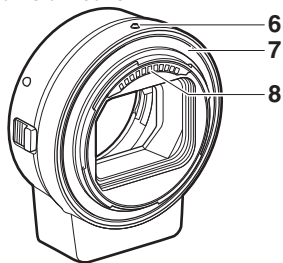

- 6 Adapter mounting mark
- 7 Nikon Z mount (attaches to camera)
- 8 CPU contacts

## ■ Attachment and Removal

Turn the camera off before attaching the adapter to or removing it from the camera or attaching lenses to or removing lenses from the adapter. Choose a location out of direct sunlight and be careful to prevent dust from entering the devices. While attaching lenses, avoid pressing the camera or adapter lens release.

### Attaching the Adapter and Lens

---

**1** Remove the body and rear lens caps from the adapter and the body cap from the camera.

---

**2** Attach the adapter to the camera.

Keeping the adapter mounting mark aligned with the mounting mark on the camera body (①), position the adapter on the camera and then rotate it counterclockwise until it clicks into place (②).

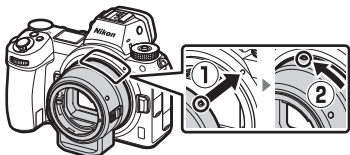

**3** Remove the rear lens cap.

---



---

## 4 Attach the lens to the adapter.

Keeping the lens mounting mark aligned with the lens mounting mark on the adapter (③), position the lens on the adapter and then rotate it counterclockwise until it clicks into place (④).

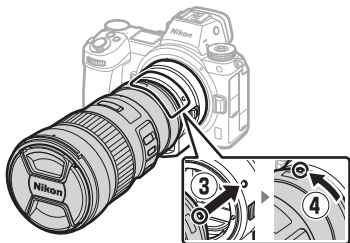

## Detaching the Lens and Adapter

---

### 1 Detach the lens.

Press and hold the adapter lens release (①) while turning the lens clockwise (②). Attach the front and rear caps to the lens after removal.

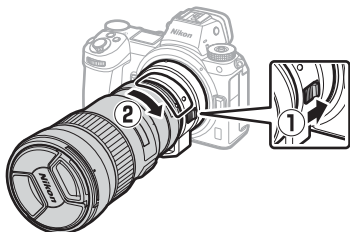

---

### 2 Detach the adapter.

Press and hold the camera lens release button (③) while turning the adapter clockwise (④). After removing the adapter, attach the body and rear caps to the adapter and the body cap to the camera.



### ✔ CPU Lenses with Aperture Rings

Select minimum aperture (the highest f/-number) before attaching CPU lenses equipped with aperture rings.

### ✔ Incompatible Lenses and Accessories

The following lenses and accessories cannot be used. Attempting to forcibly attach any of this equipment could damage the adapter or the lens. Individual variation may render lenses other than those listed below incompatible; do not use force if you encounter resistance when attempting to attach a lens.

- Non-AI lenses
- IX-NIKKOR
- TC-16A AF Teleconverter
- Lenses that require the AU-1 focusing unit (400mm f/4.5, 600mm f/5.6, 800mm f/8, 1200mm f/11)
- Fisheye (6mm f/5.6, 7.5mm f/5.6, 8mm f/8, OP 10mm f/5.6)
- 2.1cm f/4
- K2 Extension Ring
- 180–600mm f/8 ED (serial numbers 174041–174180)
- 360–1200mm f/11 ED (serial numbers 174031–174127)
- 200–600mm f/9.5 (serial numbers 280001–300490)
- AF lenses for the F3AF (AF 80mm f/2.8, AF 200mm f/3.5 ED, TC-16 AF Teleconverter)
- PC 28mm f/4 (serial number 180900 or earlier)
- PC 35mm f/2.8 (serial numbers 851001–906200)
- PC 35mm f/3.5 (old type)
- Reflex 1000mm f/6.3 (old type)
- NIKKOR-H Auto 2.8cm f/3.5 (28mm f/3.5) lenses with serial numbers below 362000
- NIKKOR-S Auto 3.5cm f/2.8 (35mm f/2.8) lenses with serial numbers below 928000
- NIKKOR-S Auto 5cm f/2 (50mm f/2)
- NIKKOR-Q Auto 13.5cm f/3.5 (135mm f/3.5) lenses with serial numbers below 753000
- Micro-NIKKOR 5.5cm f/3.5
- Medical-NIKKOR Auto 200mm f/5.6
- Auto NIKKOR Telephoto-Zoom 85–250mm f/4–4.5
- Auto NIKKOR Telephoto-Zoom 200–600mm f/9.5–10.5

## **Using the Mount Adapter**

- Autofocus may not function as expected when the adapter is used with an F mount NIKKOR lens. If the camera has trouble focusing, set the AF-area mode to single point and select the center focus area, or focus manually.
- With some lenses, the camera vibration reduction feature may not function as expected or may cause vignetting or a drop in peripheral illumination.

## **Precautions for Use**

- When using the adapter with lenses weighing over 1300 g (2 lb 13.9 oz), support the lens when holding the camera and do not use the camera strap. Failure to observe these precautions could damage the camera lens mount.
- When using telephoto lenses equipped with a tripod collar, attach the tripod to the lens tripod collar rather than to the adapter tripod socket.
- Keep the CPU and lens signal contacts clean.
- Keep the adapter dry. Rusting of the internal mechanism can cause irreparable damage.
- Leaving the adapter in extremely hot locations could damage or warp parts made from reinforced plastic.

## **Caring for the Adapter**

- Do not touch the interior of the mount adapter. Use a blower or soft brush to remove dust, being careful not to rub or scratch the inside of the adapter.
- When cleaning the adapter, use a blower to remove dust and lint and then wipe the adapter gently with a soft, dry cloth.
- Never use organic solvents such as paint thinner or benzene to clean the adapter.
- If the adapter will not be used for an extended period, store it in a cool, dry location to prevent mold and rust. Do not store in direct sunlight or with naphtha or camphor moth balls.

## **Accessories**

### **■ Supplied Accessories**

- BF-1B Body Cap
- LF-N1 Rear Lens Cap

## **Specifications**

<b>Type</b>	Mount adapter
<b>Supported cameras</b>	Nikon Z mount mirrorless cameras
<b>Dimensions</b>	Approx. 70 mm diameter (excluding projections) × 80 mm
<b>Weight</b>	Approx. 135 g (4.8 oz)

Nikon reserves the right to change the appearance, specifications, and performance of this product at any time and without prior notice.

## Approved Memory Cards

The camera can be used with XQD and CFexpress (Type B) memory cards. Cards with write speeds of 45 MB/s (300×) or better are recommended for movie recording; slower speeds may interrupt recording or playback or result in playback that is jerky and uneven. For information on compatibility and operation, contact the manufacturer.

## Memory Card Capacity

The following table shows the approximate number of pictures that can be stored on a 64 GB Sony G-series QD-G64E XQD card at different image quality and size settings when **FX (36 × 24)** is selected for **Choose image area** (as of July 2018).

Z7:

Image quality		Image size	File size <sup>1</sup>	No. of images <sup>1</sup>	Buffer capacity <sup>2</sup>		
NEF (RAW)	Lossless compressed	12-bit	Large	44.7 MB	748	23	
			Medium	31.5 MB	1000	19	
		Small	24.5 MB	1400	19		
	Compressed	14-bit	Large		55.8 MB	654	19
		12-bit			40.7 MB	1000	23
		14-bit			49.4 MB	845	19
		12-bit			74.1 MB	748	23
		14-bit			85.1 MB	654	18
Uncompressed	12-bit						
	14-bit						
TIFF (RGB)		Large	134.6 MB	412	21		
		Medium	76.5 MB	723	22		
		Small	34.8 MB	1500	25		
JPEG <sup>3</sup>	Fine	Large	17.2 MB	1900	25		
		Medium	11.7 MB	3200	25		
		Small	6.8 MB	6500	25		
	Normal	Large	11.8 MB	3700	25		
		Medium	7.0 MB	6400	25		
		Small	3.5 MB	12,700	25		
	Basic	Large	3.8 MB	7500	25		
		Medium	2.6 MB	12,300	25		
		Small	1.6 MB	24,100	25		

## Z 6:

Image quality		Image size	File size <sup>1</sup>	No. of images <sup>1</sup>	Buffer capacity <sup>2</sup>		
NEF (RAW)	Lossless compressed	12-bit	Large	22.5 MB	1300	35	
			Medium	16.1 MB	1900	26	
		Small	12.7 MB	2500	26		
	Compressed	14-bit	Large		28.2 MB	1100	43
					20.4 MB	1800	37
					24.8 MB	1500	43
					38.5 MB	1300	33
					44.1 MB	1100	34
Uncompressed	12-bit		38.5 MB	1300	33		
	14-bit		44.1 MB	1100	34		
TIFF (RGB)		Large	69.3 MB	759	27		
		Medium	39.5 MB	1300	31		
		Small	18.4 MB	2800	35		
JPEG <sup>3</sup>	Fine	Large	9.4 MB	3400	44		
		Medium	6.6 MB	5600	50		
		Small	4.0 MB	10,400	51		
	Normal	Large	6.4 MB	6700	44		
		Medium	3.9 MB	10,900	50		
		Small	2.1 MB	19,900	51		
	Basic	Large	2.3 MB	13,000	46		
		Medium	1.7 MB	20,800	50		
		Small	1.2 MB	35,200	50		

- 1 All figures are approximate. File size, and with it the buffer capacity and number of images that can be recorded, varies with scene recorded.
- 2 Maximum number of exposures that can be stored in memory buffer at ISO 100. May drop in some situations, for example at image qualities marked with a star ("★") or if auto distortion control is on.
- 3 Figures assume size-priority JPEG compression. Selecting an image-quality option marked with a star ("★"; optimal compression) increases the file size of JPEG images; number of images and buffer capacity drop accordingly.

## Battery Endurance

The approximate length of footage or number of shots that can be recorded with a fully-charged EN-EL15b<sup>1</sup> battery varies with the monitor mode. The figures for photographs<sup>2</sup> are as follows:

- **Viewfinder only:** 330 shots (Z 7), 310 shots (Z 6)
- **Monitor only:** 400 shots (Z 7), 380 shots (Z 6)

The figures for movies<sup>3</sup> are:

- **Viewfinder only:** 85 minutes
- **Monitor only:** 85 minutes

Actions such as the following can reduce battery endurance:

- Keeping the shutter-release button pressed halfway
- Repeated autofocus operations
- Taking NEF (RAW) photographs
- Slow shutter speeds
- Using camera Wi-Fi (wireless LAN) and Bluetooth features
- Using the camera with optional accessories connected
- Repeatedly zooming in and out

To ensure that you get the most from rechargeable Nikon EN-EL15b batteries:

- Keep the battery contacts clean. Soiled contacts can reduce battery performance.
- Use batteries immediately after charging. Batteries will lose their charge if left unused.

- 1 EN-EL15a/EN-EL15 batteries can also be used, but note that you may not be able to take as many pictures on a single charge. Endurance varies with the condition of the battery, the temperature, the interval between shots, and the length of time menus are displayed.
- 2 CIPA standard. Measured at 23 °C/73.4 °F ( $\pm 2$  °C/3.6 °F) with a NIKKOR Z 24–70mm f/4 S lens and a SONY QD-G64E memory card (data current as of July 2018) under the following test conditions: one photograph taken at default settings once every 30 s.
- 3 Measured at 23 °C/73.4 °F ( $\pm 2$  °C/3.6 °F) with the camera at default settings, a NIKKOR Z 24–70mm f/4 S lens, and a SONY QD-G64E memory card (data current as of July 2018) under conditions specified by the Camera and Imaging Products Association (CIPA). Individual movies can be up to 29 minutes 59 seconds in length; recording may end before this limit is reached if the camera temperature rises.



## Notices

### Notices for Customers in the U.S.A.

#### The Battery Charger

## IMPORTANT SAFETY INSTRUCTIONS—SAVE THESE INSTRUCTIONS

## DANGER—TO REDUCE THE RISK OF FIRE OR ELECTRIC SHOCK, CAREFULLY FOLLOW THESE INSTRUCTIONS

For connection to a supply not in the U.S.A., use an attachment plug adapter of the proper configuration for the power outlet if needed. This power unit is intended to be correctly oriented in a vertical or floor mount position.

### Federal Communications Commission (FCC) Radio Frequency Interference Statement

This equipment has been tested and found to comply with the limits for a Class B digital device, pursuant to Part 15 of the FCC rules. These limits are designed to provide reasonable protection against harmful interference in a residential installation. This equipment generates, uses, and can radiate radio frequency energy and, if not installed and used in accordance with the instructions, may cause harmful interference to radio communications. However, there is no guarantee that interference will not occur in a particular installation. If this equipment does cause harmful interference to radio or television reception, which can be determined by turning the equipment off and on, the user is encouraged to try to correct the interference by one or more of the following measures:

- Reorient or relocate the receiving antenna.
- Increase the separation between the equipment and receiver.
- Connect the equipment into an outlet on a circuit different from that to which the receiver is connected.
- Consult the dealer or an experienced radio/television technician for help.



**Nikon**  
Z 7/Z 6

#### CAUTIONS

##### *Modifications*

The FCC requires the user to be notified that any changes or modifications made to this device that are not expressly approved by Nikon Corporation may void the user's authority to operate the equipment.

##### *Interface Cables*

Use the interface cables sold or provided by Nikon for your equipment. Using other interface cables may exceed the limits of Class B Part 15 of the FCC rules.

Nikon Inc., 1300 Walt Whitman Road,  
Melville, New York 11747-3064, U.S.A.  
Tel.: 631-547-4200

### **Power Cable**

**At voltages over AC 125 V (U.S.A. only):** The power cable must be rated for the voltage in use, be at least AWG no. 18 gauge, and have SVG insulation or better with a NEMA 6P-15 plug rated for AC 250 V 15 A.

### **Notice for Customers in Canada**

CAN ICES-3 B / NMB-3 B

## **Bluetooth and Wi-Fi (Wireless LAN)**

This product is controlled by the United States Export Administration Regulations (EAR). The permission of the United States government is not required for export to countries other than the following, which as of this writing are subject to embargo or special controls: Cuba, Iran, North Korea, Sudan, and Syria (list subject to change).

The use of wireless devices may be prohibited in some countries or regions. Contact a Nikon-authorized service representative before using the wireless features of this product outside the country of purchase.

The Bluetooth transmitter in this device operates in the 2.4 GHz band.

### **Notice for Customers in the U.S.A. and Canada**

This device complies with part 15 of FCC Rules and Innovation, Science and Economic Development Canada's licence-exempt RSSs. Operation is subject to the following two conditions: (1) this device may not cause harmful interference, and (2) this device must accept any interference received, including interference that may cause undesired operation.

### **FCC WARNING**

The FCC requires the user to be notified that any changes or modifications made to this device that are not expressly approved by Nikon Corporation may void the user's authority to operate the equipment.

### **Compliance with FCC requirement 15.407(c)**

Data transmission is always initiated by software, which is then passed down through the MAC, through the digital and analog baseband, and finally to the RF chip. Several special packets are initiated by the MAC. These are the only ways the digital baseband portion will turn on the RF transmitter, which it then turns off at the end of the packet. Therefore, the transmitter will be on only while one of the aforementioned packets is being transmitted. In other words, this device automatically discontinues transmission in case of either absence of information to transmit or operational failure.

Frequency Tolerance:  $\pm 20$  ppm

### **FCC Radio Frequency Interference Statement**

Note: This equipment has been tested and found to comply with the limits for a Class B digital device, pursuant to part 15 of the FCC Rules. These limits are designed to provide reasonable protection against harmful interference in a residential installation. This equipment generates, uses and can radiate radio frequency energy and, if not installed and used in accordance with the instructions, may cause harmful interference to radio communications. However, there is no guarantee that interference will not occur in a particular installation. If this equipment does cause harmful interference to radio or television reception, which can be determined by turning the equipment off and on, the user is encouraged to try to correct the interference by one or more of the following measures:

- Reorient or relocate the receiving antenna.
- Increase the separation between the equipment and receiver.
- Connect the equipment into an outlet on a circuit different from that to which the receiver is connected.
- Consult the dealer or an experienced radio/TV technician for help.

### **Co-location**

This transmitter must not be co-located or operated in conjunction with any other antenna or transmitter.

Nikon Inc., 1300 Walt Whitman Road, Melville, New York 11747-3064, U.S.A.  
Tel.: 631-547-4200

### **FCC/ISED RF Exposure Statement**

The available scientific evidence does not show that any health problems are associated with using low power wireless devices. There is no proof, however, that these low power wireless devices are absolutely safe. Low power Wireless devices emit low levels of radio frequency energy (RF) in the microwave range while being used. Whereas high levels of RF can produce health effects (by heating tissue), exposure of low-level RF that does not produce heating effects causes no known adverse health effects. Many studies of low-level RF exposures have not found any biological effects. Some studies have suggested that some biological effects might occur, but such findings have not been confirmed by additional research. This product has been tested and found to comply with FCC/ISED radiation exposure limits set forth for an uncontrolled environment and meets the FCC radio frequency (RF) Exposure Guidelines and RSS-102 of the ISED radio frequency (RF) Exposure rules. Please refer to the SAR test report that was uploaded to FCC website.

### **Compliance with RSS-247 Issue 2 §6.4**

Data transmission is always initiated by software, which is the passed down through the MAC, through the digital and analog baseband, and finally to the RF chip. Several special packets are initiated by the MAC. These are the only ways the digital baseband portion will turn on the RF transmitter, which it then turns off at the end of the packet. Therefore, the transmitter will be on only while one of the aforementioned packets is being transmitted. In other words, this device automatically discontinues transmission in case of either absence of information to transmit or operational failure.

### **Notice for Customers in Canada**

For indoor use only (5150-5350MHz).

### **Notices for Customers in the French Overseas Collectivity of Saint Martin**



Hereby, Nikon Corporation declares that the radio equipment types Z 7 and Z 6 are in compliance with Directive 2014/53/EU.

The full texts of the EU declarations of conformity are available at the following internet addresses:

- **Z7:** [https://imaging.nikon.com/support/pdf/DoC\\_N1710.pdf](https://imaging.nikon.com/support/pdf/DoC_N1710.pdf)
- **Z6:** [https://imaging.nikon.com/support/pdf/DoC\\_N1711.pdf](https://imaging.nikon.com/support/pdf/DoC_N1711.pdf)

## Security

Although one of the benefits of this product is that it allows others to freely connect for the wireless exchange of data anywhere within its range, the following may occur if security is not enabled:

- **Data theft:** Malicious third-parties may intercept wireless transmissions to steal user IDs, passwords, and other personal information.
- **Unauthorized access:** Unauthorized users may gain access to the network and alter data or perform other malicious actions. Note that due to the design of wireless networks, specialized attacks may allow unauthorized access even when security is enabled.
- **Unsecured networks:** Connecting to open networks may result in unauthorized access. Use secure networks only.

## Conformity Marking

The standards with which the camera complies can be viewed using the **Conformity marking** option in the setup menu.

## Certificates

### • México

**IFETEL: RCPMU1M18-0171**

**1MW**

La operación de este equipo está sujeta a las siguientes dos condiciones:

- (1) es posible que este equipo o dispositivo no cause interferencia perjudicial y
- (2) este equipo o dispositivo debe aceptar cualquier interferencia, incluyendo la que pueda causar su operación no deseada.

# Index

## Symbols

(Auto mode) .....	41, 45, 72
<b>P</b> (Programmed auto) .....	72, 73
<b>S</b> (Shutter-priority auto) .....	72, 73
<b>A</b> (Aperture-priority auto) .....	72, 74
<b>M</b> (Manual) .....	72, 75
<b>U1/U2/U3</b> .....	72, 77
(Single frame) .....	87, 90, 114
L (Continuous L) .....	87, 114
H (Continuous H) .....	87, 114
H' (Continuous H (extended)) ...	88, 114
(Self-timer) .....	88, 90, 114
(Pinpoint AF) .....	54, 116
(Single-point AF) .....	54, 116, 124
(Dynamic-area AF) .....	55, 116
(Wide-area AF (S)) .....	55, 116, 124
(Wide-area AF (L)) .....	55, 116, 124
(Auto-area AF) .....	56, 116, 124
(Matrix) .....	111
(Center-weighted) .....	111
(Spot) .....	111
* (Highlight-weighted) .....	111
(Red-eye reduction) .....	110
SLOW (Slow sync) .....	110
REAR (Rear-curtain sync) .....	110
(Exposure compensation) .....	85
button .....	49
button .....	51
<b>MENU</b> button .....	18
(☺) button .....	87
<b>ISO</b> button .....	82, 84
(?) button .....	20
i button .....	21, 95
button .....	18
(In-focus indicator) .....	62
(Flash-ready indicator) .....	185

icon .....	40
------------	----

## Numerics

1 : 1 (24 × 24) .....	109
16 : 9 (36 × 20) .....	109
5 : 4 (30 × 24) .....	109

## A

AC adapter .....	186, 191
Accessories .....	186
Accessory terminal .....	212
Active D-Lighting .....	113, 123
AE lock .....	92, 93
AF .....	52
AF lock .....	92, 93
AF-area mode .....	54, 116, 124
AF-assist .....	43
<b>AF-C</b> .....	53, 116, 124
<b>AF-F</b> .....	53, 124
<b>AF-ON</b> button .....	17
<b>AF-S</b> .....	52, 116, 124
Animal face/eye-detection AF .....	58
Aperture .....	74
Aperture-priority auto .....	74
Attaching the lens .....	36
Auto (Set Picture Control) .....	97
Auto (White balance) .....	65, 101
Auto ISO sensitivity control .....	84
Auto-area AF .....	56, 116, 124
Autoexposure lock .....	92, 93
Autofocus .....	52
Automatic display switch .....	9

## B

Battery .....	28, 32, 186, 215
Battery charger .....	28, 214
Battery endurance .....	238
Battery level .....	34

Body cap ..... 36, 187  
Bulb ..... 80

## C

---

Cable clip ..... 190  
Camera Control Pro 2 ..... 189  
Capture NX-D ..... 70  
Center-weighted ..... 111  
**CHARGE** lamp ..... 29, 30  
Charging AC adapter ..... 29, 186, 203, 215  
Charging the battery ..... 28  
Choose color temp. (White balance).  
66, 101, 103  
Choose image area ..... 109, 122  
Clean image sensor ..... 194  
Clock ..... 38, 40  
Clock battery ..... 40  
Cloudy (White balance) ..... 65, 101  
Color temperature ..... 66, 103  
Command dial ..... 17  
Compatible lenses ..... 204  
Continuous ..... 87, 90, 114  
Continuous H ..... 87, 114  
Continuous H (extended) ..... 88, 114  
Continuous L ..... 87, 114  
Continuous release mode ..... 87, 90, 114  
Control panel ..... 5, 180  
Control ring ..... 62, 220  
CPU contacts ..... 220  
Creative Lighting System (CLS) ... 181  
Creative Picture Control ..... 97  
Custom control assignment ..... 24  
Custom Settings ..... 141  
Customize **F** menu ..... 22

## D

---

Date and time ..... 39  
Date format ..... 40  
Daylight saving time ..... 39  
DCF ..... 216

Default settings ..... 159  
Delete ..... 51  
Delete current image ..... 51  
Diopter adjustment control ..... 8  
Direct sunlight (White balance) ... 65, 101  
**DISP** button ..... 15  
Download center ..... ii  
DX ..... 109  
DX format ..... 122  
Dynamic-area AF ..... 55, 116

## E

---

Edit movie ..... 50  
Electronic VR ..... 123  
Error messages ..... 166, 168  
Exif ..... 216  
Exposure ..... 76, 85  
Exposure compensation ..... 85  
Exposure indicator ..... 76  
Exposure lock ..... 92, 93  
Exposures remaining ..... 34  
External microphone ..... 121, 189  
Eye sensor ..... 8  
Eye-detection AF ..... 57

## F

---

Face-detection AF ..... 57  
Filter effects ..... 100  
Fine-tuning white balance ..... 102  
Flash ..... 110, 181  
Flash (White balance) ..... 65, 101  
Flash mode ..... 110  
Flash ready indicator ..... 185  
Flat (Set Picture Control) ..... 97  
Flexible program ..... 73  
Flick ..... 11  
Fluorescent (White balance) .. 65, 101  
**Fn1** button ..... 24  
**Fn2** button ..... 24  
Focal length ..... 222

Focal length scale .....	222
Focal plane mark.....	63
Focus indicator .....	62
Focus lock .....	92, 93
Focus mode.....	52, 116, 124
Focus point.....	92
Frame rate.....	88, 119
Frame size/frame rate.....	119
Full-frame playback.....	11, 49
Function buttons .....	24
FV lock.....	184
FX.....	109, 122

## H

---

HDMI.....	216
HDMI cable .....	187
Help.....	20
Hi.....	82
Highlights .....	63, 111
Highlight-weighted.....	111
Histogram .....	15, 16

## I

---

Image area.....	109, 122
Image quality.....	107
Image sensor .....	2, 194, 200
Image size .....	109
Incandescent (White balance).....	65, 101
In-focus indicator .....	62
Information display .....	15, 174
ISO sensitivity .....	82
i-TTL.....	181

## J

---

JPEG .....	107
------------	-----

## L

---

L (large) .....	109
Landscape (Set Picture Control) ....	97

Language.....	38
Lens.....	36, 219
Lens mount.....	36
Lens mounting mark .....	36
Lo.....	82

## M

---

M (medium).....	109
Main command dial.....	17
Manual.....	75
Manual focus.....	53, 62, 116, 124
Matrix metering .....	111
Maximum aperture .....	185
Maximum sensitivity .....	84
Memory buffer.....	89
Memory card .....	32, 235, 236
Memory card capacity .....	236
Menu list .....	125
Metering .....	111
MF.....	53, 116, 124
Microphone .....	121, 189
Microphone sensitivity .....	121
Minimum aperture.....	232
Mode dial.....	72
Mode dial lock release .....	72
Monitor.....	6, 10, 171
Monitor mode button.....	8
Monitor pre-flash.....	184
Monochrome (Set Picture Control)....	97
Mount adapter.....	228
Movie quality.....	119
Movie shooting menu.....	135
Movie-record button.....	46
Movies .....	45, 49, 117
Multi selector .....	18
My Menu .....	158

## N

---

Natural light auto (White balance)....	65, 101
--	---------



NEF (RAW) .....	107	Release mode .....	87, 114
Neutral (Set Picture Control) .....	97	Remote cord .....	80, 187
Number of shots .....	238	Removing the lens from the camera	
<b>O</b>		37	
Online manual .....	125	Reset user settings .....	78
<b>P</b>		Restoring default settings .....	159
Photo shooting menu .....	127	Retouch menu .....	156
Photo/movie selector .....	41, 45	RGB .....	107
PictBridge .....	216	<b>S</b>	
Picture Controls .....	97	<b>S</b> (small) .....	109
Pinpoint AF .....	54, 116	Same as photo settings .....	117
Playback .....	11, 49	Save user settings .....	77
Playback menu .....	125	Self-timer .....	88, 90, 114
Playback zoom .....	12	Sensitivity .....	82
Portrait (Set Picture Control) .....	97	Set Picture Control .....	97
Power connector .....	186, 191	Setup menu .....	150
Power switch .....	38	Shade (White balance) .....	101
Preset manual (White balance) .....	66, 101, 104	Shutter speed .....	73, 75
Press the shutter-release button all		Shutter-priority auto .....	73
the way down .....	44	Shutter-release button .....	43, 44
Press the shutter-release button		Silent photography .....	68
halfway .....	43	Single frame .....	87, 90, 114
Prioritize viewfinder .....	9	Single-point AF .....	54, 116, 124
Problems and solutions .....	160	Size .....	109
Product serial number .....	4	Slow sync .....	110
Programmed auto .....	73	Slow-motion movies .....	120
Protecting photographs .....	71	Smart device .....	40, 112
<b>Q</b>		SnapBridge .....	40
Quick sharp .....	100	Specifications .....	204
<b>R</b>		Spot .....	111
Rear-curtain sync .....	110	Standard (Set Picture Control) .....	97
Recent settings .....	158	Standard i-TTL fill-flash .....	181
Rechargeable Li-ion battery .....	28, 186, 215	Standby timer .....	44
Red-eye reduction .....	110	Sub-command dial .....	17
		Subject tracking .....	59
		Sub-selector .....	17, 92
		<b>T</b>	
		Text entry .....	13
		Thumbnail .....	12

TIFF (RGB) .....	107
Tilting monitor .....	3
Time .....	80
Time zone .....	39
Time zone and date.....	39
Touch controls .....	10, 60
Touch screen .....	10, 60
Touch shutter .....	10, 60
Trademark Information.....	217
Trimming movies .....	50
Tripod.....	80
Troubleshooting.....	159

## **U**

---

User settings .....	77
---------------------	----

## **V**

---

Vibration reduction .....	115
Viewfinder .....	8, 177
Viewfinder eyepiece .....	8, 188
Viewfinder eyepiece cap .....	188
Viewfinder focus.....	8
ViewNX-i.....	70
Virtual horizon.....	15, 16
Vivid (Set Picture Control).....	97
Volume.....	50

## **W**

---

WB (White balance) .....	64, 101
White balance .....	64, 101
Wide-area AF .....	55, 116, 124
Wi-Fi .....	112
Wireless remote controller .....	188
Wireless transmitter (WT-7) .....	187

## **X**

---

XQD memory card .....	235
-----------------------	-----











No reproduction in any form of this manual, in whole or in part (except for brief quotation in critical articles or reviews), may be made without written authorization from NIKON CORPORATION.

**NIKON CORPORATION**

---

© 2018 Nikon Corporation

Printed in Japan

SB0C04(11)

6MOA1311-04