

Z 30

User's Manual (with Warranty)

- Read this document thoroughly before using the camera.
- To ensure proper use of the camera, be sure to read "For your safety" (overleaf).
- After reading this document, keep it readily accessible for future reference.

No reproduction in any form of this document, in whole or in part (except for brief quotation in critical articles or reviews), may be made without written authorization from NIKON CORPORATION.



Nikon Europe Service Warranty Card	
Model name Nikon Z 30	Serial No. Purchase date
Name and address of customer	
Dealer	
Distributor Nikon Europe B.V. Trippolis 100, Burgenweeshuispad 101, 1076 ER Amsterdam, The Netherlands	Manufacturer NIKON CORPORATION Shinagawa Intercity Tower C, 2-15-3, Konan, Minato-ku, Tokyo 108-6290 Japan

Warranty terms - Nikon Europe service warranty

Dear Nikon customer,
We thank you for your purchasing this Nikon product. Should your Nikon product require warranty service, please contact the dealer from whom it was purchased or a member of our authorized service network within the sales territory of Nikon Europe B.V. (e.g. Europe/Russia/others). See details under:
<https://www.europe-nikon.com/support>

In order to avoid any unnecessary inconvenience, we advise you to read the user manuals carefully before contacting the dealer or our authorized service network.

Your Nikon equipment is guaranteed against any manufacturing defects for one full year from the date of original purchase. If during this period of guarantee the product proves defective due to improper material or workmanship, our authorized service network within the sales territory of Nikon Europe B.V. will, without charge for labor and parts, repair the product in the terms and conditions set as below. Nikon reserves the right (at its sole discretion) to replace or repair the product.

1. This warranty is only provided upon presentation of the completed warranty card and original invoice or purchase receipt indicating the date of purchase, product type and dealer's name, together with the product. Nikon reserves the right to refuse free-of-charge warranty service if the above documents cannot be presented or if the information contained in it is incomplete or illegible.

2. This warranty will not cover:

- necessary maintenance and repair or replacement of parts due to normal wear and tear.
- modifications to upgrade the product from its normal purpose as described in user manuals, without the prior written consent of Nikon.
- transport costs and all risks of transport relating directly or indirectly to the warranty of the products.
- any damage resulting from modifications or adjustments which may be made to the product, without the prior written consent of Nikon, in order to comply with local or national technical standards in force in any other country than the ones for which the product was originally designed and/or manufactured.

3. The warranty will not be applicable in the case of:

- damage caused by misuse including but not limited to failure to use the product for its normal purpose or according to the user instructions on the proper use and maintenance, and to installation or use of the product inconsistent with the safety standards in force in the country where it is used.
- damage caused by accidents including but not limited to lightning, water, fire, misuse or neglect.
- defacing, illegibility or removal of the model or serial number on the product.
- damage resulting from repairs or adjustments which have been conducted by unauthorized service organizations or persons.
- defects in any system into which the product is incorporated or with which it is used.

4. This service warranty does not affect the consumer's statutory rights under applicable national laws in force, nor the consumer's right against the dealer arising from their sales/purchase contract.

Notice: An overview of all authorized Nikon Service Stations can be found online by following this Link
(URL = <https://www.europe-nikon.com/service/>).

Z 30 Model Name: N2121

Nikon user support
Should you need technical support, we offer a number of options.

- **For users in the U.S.A.:**
<https://www.nikonusa.com/>
- **For users in Canada:**
<https://www.nikon.ca/>
- **For users in Mexico:**
<https://www.nikon.com.mx/>
- **For users in Latin America:**
<https://www.nikonamericalatina.com/>
- **For users in Europe:**
<https://www.europe-nikon.com/support>
- **For users in Asia, Oceania, the Middle East, and Africa:**
<https://www.nikon-asia.com/>

The Z 30 User's Manual and Reference Guide

In addition to this *User's Manual*, a *Reference Guide* is available for your camera.

The User's Manual (this sheet)

The *User's Manual* describes basic camera operations.

The Reference Guide

Camera features and operations are detailed in a *Reference Guide*, a supplement to the *User's Manual*. The *Reference Guide* can be viewed on computers, smartphones, and tablets.



nikon reference guide Z 30

<https://onlinemanual.nikonimglib.com/z30/en/>



Lens kit lenses

For information on lenses supplied as part of a lens kit, see the lens documentation available for download from the Nikon Download Center.

The Nikon Download Center

Visit the Nikon download center to download the latest firmware for cameras and lenses, NX Studio and other Nikon software, and documentation for Nikon products including cameras, NIKKOR lenses, and flash units.
<https://downloadcenter.nikonimglib.com/>



Genuine Nikon software

Nikon computer software such as NX Studio is available from the Nikon Download Center. For more information, see the "Reference Guide".

Package contents

Be sure all items listed here were included with your camera.

- Camera
- AN-DC25 strap
- BF-N1 body cap
- Warranty (see left)
- EN-EL25 rechargeable Li-ion battery
- User's Manual (this sheet)
- UC-E24 USB cable

- Memory cards are sold separately.
- Purchasers of the lens kit option should confirm that the package also includes a lens.
- This camera uses SD, SDHC, and SDXC memory cards, referred to throughout this document as "memory cards".

Parts of the camera

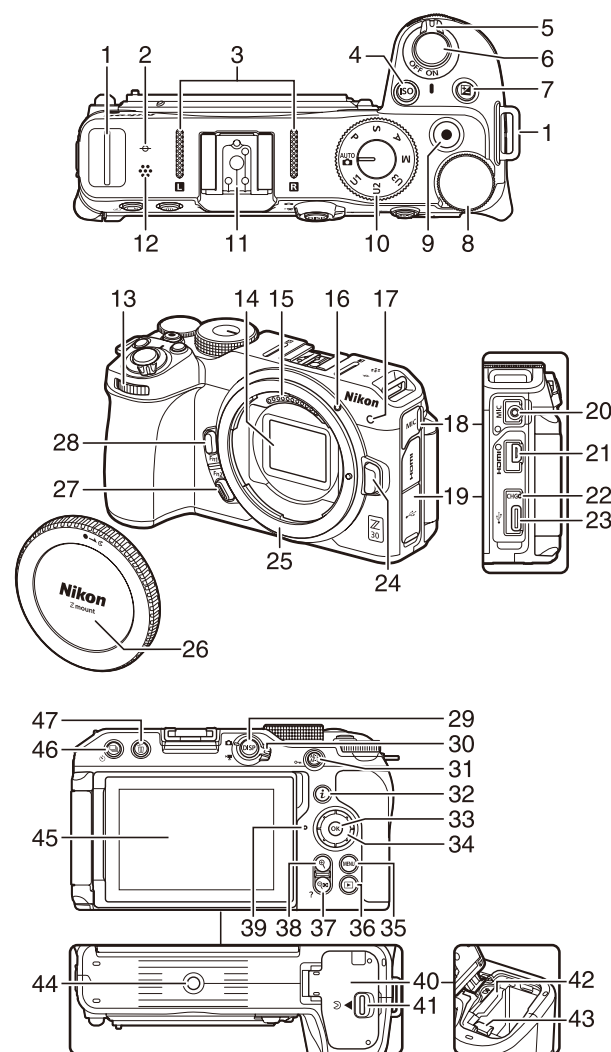

1	Eyelet for camera strap	24	Lens release button
2	☉ (focal plane mark)	25	Lens mount
3	Stereo microphone	26	Body cap
4	ISO button	27	Fn2 button
5	Power switch	28	Fn1 button
6	Shutter-release button	29	DISP button
7	☑ button	30	Photo/video selector
8	Main command dial	31	☑ (On) button
9	Video-record button	32	⌂ button
10	Mode dial	33	⊕ button
11	Accessory shoe (for optional flash unit)	34	Multi selector
12	Speaker	35	MENU button
13	Sub-command dial	36	☒ button
14	Image sensor	37	☑ (?) button
15	CPU contacts	38	☒ button
16	Lens mounting mark	39	Memory card access lamp
17	REC lamp	40	Battery-chamber/memory card slot cover
18	Self-timer lamp	41	Battery-chamber/memory card slot cover latch
19	Cover for microphone connector	42	Memory card slot
20	Cover for HDMI and USB connectors	43	Battery latch
21	Connector for external microphone	44	Tripod socket
22	HDMI connector	45	Monitor
23	USB connector	46	☑ (S) button
		47	☑ button

- Throughout this document, the display in camera monitor during shooting is referred to as the "shooting display".

First steps

Attaching the strap

To attach a strap (whether the supplied strap or one that has been purchased separately):

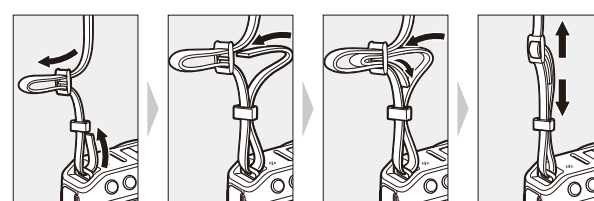

Inserting the battery and a memory card

- Turn the camera off before inserting or removing the battery and memory card.
- Using the battery to keep the orange battery latch pressed to one side, slide the battery into the battery chamber until the latch locks it in place.
- Holding the memory card in the orientation shown, slide it straight into the slot until it clicks into place.

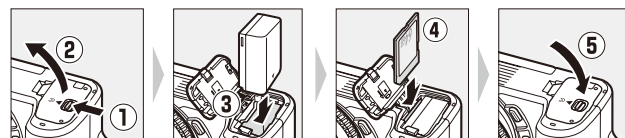

Charging the battery

Fully charge the supplied EN-EL25 battery before use. With the battery inserted in the camera, connect the camera with a computer using the supplied USB cable to charge.

Battery care

Read and follow the warnings and cautions in "For your safety" (overleaf) and "Caring for the camera and battery: Cautions" (overleaf).

- 1 Insert the EN-EL25 into the camera.

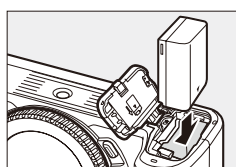

- 2 After confirming that the camera is off, connect the supplied USB cable (1) to the camera, and then connect it to a computer. Do not use force or attempt to insert the connectors at an angle.

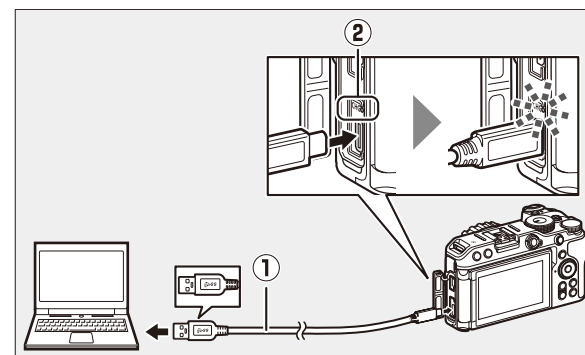

- Turn on the computer before charging.
- The camera charge lamp (2) lights amber while charging is in progress. The lamp turns off when charging is complete.
- A battery will fully charge in about 7 hours and 40 minutes (when charging an exhausted battery at an input of 5 V/500 mA). Depending on the standard and type of USB connector on the computer, the charging time may be shorter.
- When charging is complete, disconnect the USB cable. Be sure to keep the connectors straight when disconnecting them.
- Computers will also supply current to power the battery when connected via a UC-E25 USB cable (available separately).

Notes when charging using the supplied USB cable

- If the battery cannot be charged using the supplied USB cable to connect the camera and computer, for example because the battery is not compatible or the temperature of the camera is elevated, the charge lamp will flash rapidly for about 30 seconds and then turn off. If the charge lamp is off and you did not observe the battery charging, turn the camera on and check the battery level.
- When charging, do not use the connectors of a USB hub or keyboard. Connect the camera and computer directly.
- If the computer goes into hibernation (sleep mode) while charging, the camera stops charging. To continue charging, wake up the computer from hibernation (sleep mode).
- Depending on the model and product specifications, some computers will not supply current to charge the camera.

Using the supplied USB cable or a separately sold UC-E25 USB cable to supply power

- If **[Enable]** is selected for **[USB power delivery]** in the setup menu, the camera will be supplied with power when it is turned on.
- The battery will not charge while the camera is powered by an outside source.
- If you use the supplied USB cable to supply power from a computer, the camera battery will be consumed even while power is being supplied. If you use the separately sold UC-E25 USB cable, the camera battery will not be consumed (the camera battery may be consumed depending on your computer model and specifications).

Charging or supplying power from a household outlet

When charging or supplying power from a household outlet, use the separately sold EH-7P Charging AC Adapter.

Attaching a lens

- The camera can be used with Z mount lenses. The lens generally used in this document for illustrative purposes is a NIKKOR Z DX 16-50mm f/3.5-6.3 VR.
- Be careful to prevent dust entering the camera.
- Confirm that the camera is off before attaching the lens.
 - Remove the camera body cap (1, 2) and rear lens cap (3, 4).

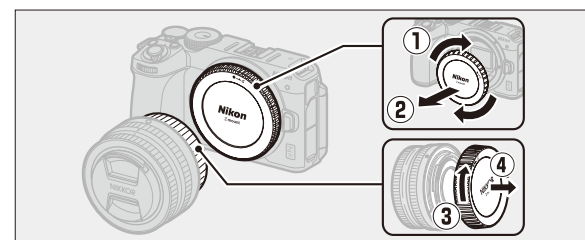

- Align the mounting marks on the camera (5) and lens (6). Do not touch the image sensor or lens contacts.

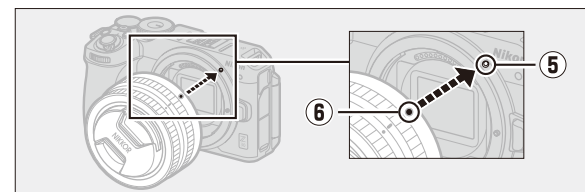

- Rotate the lens as shown until it clicks into place (7).

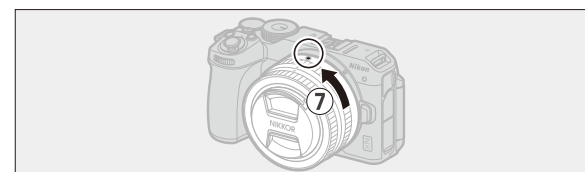

- Remove the front lens cap before taking pictures.

Detaching lenses

- After turning the camera off, press and hold the lens release button while turning the lens in the direction opposite that of attachment to detach the lens.
- After removing the lens, replace the lens caps and camera body cap.

Opening the monitor

Slowly rotate the monitor without using excessive force.

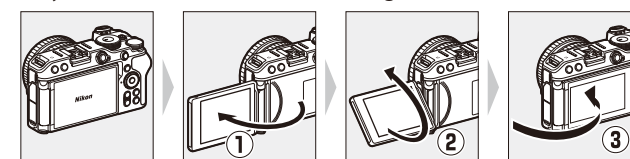

Turning on the camera

When the camera is turned on for the first time, the language selection screen is displayed. Choose a language and then set the camera clock (no other operations can be performed until the clock is set).

- 1 Turn the camera on.

- The **[Language]** selection screen will be displayed.

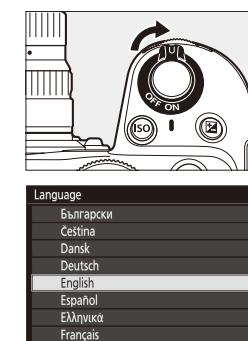

- 2 Select a language.

- Press \odot or \oplus to highlight the desired language and press \odot (the languages available vary with the country or region in which the camera was originally purchased).
- The **[Time zone]** screen will be displayed.

- 3 Choose a time zone.

- Press \odot or \oplus to choose a time zone and press \odot .
- The display shows the selected cities in the chosen zone and the difference between the time in the chosen zone and UTC.
- The **[Date format]** screen will be displayed.



- 4 Choose a date format.

- Highlight the desired date (year, month, and day) display order and press \odot .
- The **[Daylight saving time]** screen will be displayed.

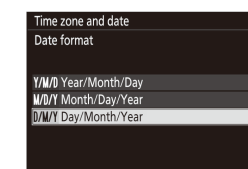

- 5 Turn daylight saving time on or off.

- Highlight **[On]** (daylight saving time on) or **[Off]** (daylight saving time off) and press \odot .
- Selecting **[On]** advances the clock one hour; to undo the effect, select **[Off]**.
- The **[Date and time]** screen will be displayed.

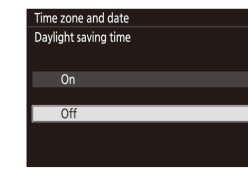

- 6 Set the clock.

- Press \odot or \oplus to highlight date and time items and press \odot or \oplus to change them.
- Press \odot to confirm the date and time setting.
- The message **[Done.]** will be displayed and the camera switches to shooting mode.

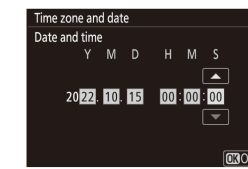

Taking photographs easily (AUTO auto)

Lenses with retractable barrels

Lenses with retractable barrels must be extended before use. Rotate the zoom ring as shown until the lens clicks into the extended position.

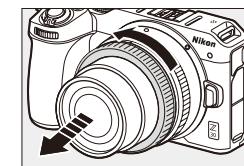

- 1 Select photo mode by rotating the photo/video selector to \odot .

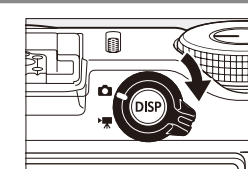

- 2 Rotate the mode dial to \odot .

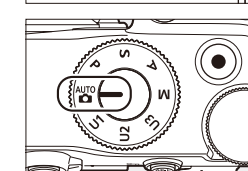

- 3 Ready the camera.



- 4 Frame the photograph.

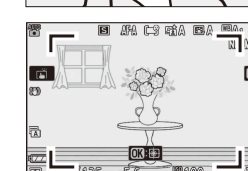

- 5 Press the shutter-release button halfway to focus.



- 6 Smoothly press the shutter-release button the rest of the way down to take the photograph.

Recording videos easily (AUTO auto)

- 1 Select video mode by rotating the photo/video selector to \odot .

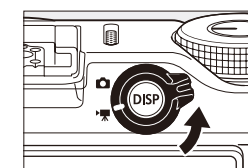

- 2 Rotate the mode dial to \odot .

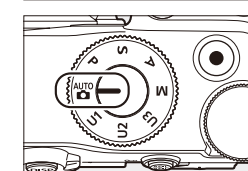

- 3 Press the video-record button to start recording.

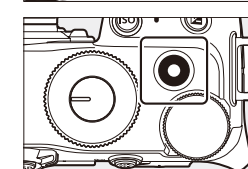

- The REC lamp will light and a recording indicator (1) will be displayed in the monitor. The monitor also shows the time remaining, or in other words the approximate amount of new footage that can be recorded to the memory card (2).

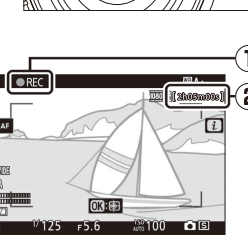
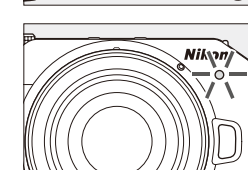

- 4 Press the video-record button again to end recording.

Viewing photos

Press the \square button to view photos and videos recorded with the camera on the monitor.

- Press \odot or \oplus , or flick left or right on the monitor to view other images.

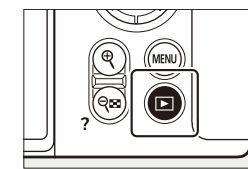

- Videos are indicated by a \square icon at the upper left of the monitor. Press the \odot button, or tap the \odot icon in the monitor to play back videos.
- To end playback and return to shooting mode, press the shutter-release button halfway.

Caring for the camera

Storage

When the camera will not be used for an extended period, remove the battery. Before removing the battery, confirm that the camera is off. Do not store the camera in locations that:

- are poorly ventilated or subject to humidities of over 60%
- are next to equipment that produces strong electromagnetic fields, such as televisions or radios
- are exposed to temperatures above 50 °C (122 °F) or below -10 °C (14 °F)

Troubleshooting

You may be able to resolve any issues with the camera by following the steps below. Check this list before consulting your retailer or Nikon-authorized service representative.

STEP 1 Check the list of common problems.

Common problems and solutions are listed in the troubleshooting section of the *Reference Guide*.

STEP 2 Turn the camera off and remove the battery, then wait about a minute, re-insert the battery and turn the camera on.

- The camera may continue to write data to the memory card after shooting. Wait at least a minute before removing the battery.

STEP 3 Search Nikon websites.

- For support information and answers to frequently asked questions, visit the website for your country or region (see "Nikon user support" at the top left corner of this page).
- To download the latest firmware for your camera, visit: <https://downloadcenter.nikonimglib.com/>

STEP 4 Consult a Nikon-authorized service representative.

For your safety

To prevent damage to property or injury to yourself or to others, read “For your safety” in its entirety before using this product.

After reading these safety instructions, keep them readily accessible for future reference.

⚠ DANGER: Failure to observe the precautions marked with this icon carries a high risk of death or severe injury.

⚠ WARNING: Failure to observe the precautions marked with this icon could result in death or severe injury.

⚠ CAUTION: Failure to observe the precautions marked with this icon could result in injury or property damage.

⚠ WARNING

Do not use while walking or operating a vehicle.

Failure to observe this precaution could result in accidents or other injury.

Do not disassemble or modify this product. Do not touch internal parts that become exposed as the result of a fall or other accident.

Failure to observe these precautions could result in electric shock or other injury.

Should you notice any abnormalities such as the product producing smoke, heat, or unusual odors, immediately disconnect the battery or power source. Continued operation could result in fire, burns or other injury.

Keep dry. Do not handle with wet hands. Do not handle the plug with wet hands. Failure to observe these precautions could result in fire or electric shock.

Do not let your skin remain in prolonged contact with this product while it is on or plugged in.

Failure to observe this precaution could result in low-temperature burns.

Do not use this product in the presence of flammable dust or gas such as propane, gasoline or aerosols.

Failure to observe this precaution could result in explosion or fire.

Do not directly view the sun or other bright light source through the lens. Failure to observe this precaution could result in visual impairment.

Do not aim the flash at the operator of a motor vehicle.

Failure to observe this precaution could result in accidents.

Keep this product out of reach of children.

Failure to observe this precaution could result in injury or product malfunction. In addition, note that small parts constitute a choking hazard. Should a child swallow any part of this product, seek immediate medical attention.

Do not entangle, wrap or twist the straps around your neck.

Failure to observe this precaution could result in accidents.

Do not use batteries, chargers, AC adapters, or USB cables not specifically designated for use with this product. When using batteries, chargers, AC adapters, and USB cables designated for use with this product, do not:

- Damage, modify, forcibly tug or bend the cords or cables, place them under heavy objects, or expose them to heat or flame.

- Use travel converters or adapters designed to convert from one voltage to another or with DC-to-AC inverters.

Failure to observe these precautions could result in fire or electric shock.

Do not handle the plug when charging the product or using the AC adapter during thunderstorms.

Failure to observe this precaution could result in electric shock.

Dust on or near the metal parts of the plug should be removed with a dry cloth. Continued use could result in fire.

Do not handle with bare hands in locations exposed to extremely high or low temperatures.

Failure to observe this precaution could result in burns, or frostbite.

⚠ CAUTION

Do not leave the lens pointed at the sun or other strong light sources.

Light focused by the lens could cause fire or damage to product's internal parts. When shooting backlit subjects, keep the sun well out of the frame. Sunlight focused into the camera when the sun is close to the frame could cause fire.

Turn this product off when its use is prohibited. Disable wireless features when the use of wireless equipment is prohibited.

The radio-frequency emissions produced by this product could interfere with equipment onboard aircraft or in hospitals or other medical facilities.

Remove the battery and disconnect the AC adapter if this product will not be used for an extended period.

Failure to observe this precaution could result in fire or product malfunction.

Do not fire the flash in contact with or in close proximity to the skin or objects. Failure to observe this precaution could result in burns or fire.

Do not leave the product where it will be exposed to extremely high temperatures, for an extended period such as in an enclosed automobile or in direct sunlight.

Failure to observe this precaution could result in fire or product malfunction.

Do not look at the REC lamp from short distances or for long periods.

Failure to observe this precaution could have adverse effects on vision.

Do not transport cameras or lenses with tripods or similar accessories attached.

Failure to observe this precaution could result in injury or product malfunction.

⚠ DANGER (Batteries)

Do not mishandle batteries.

Failure to observe the following precautions could result in the batteries leaking, overheating, rupturing, or catching fire:

- Use only rechargeable batteries approved for use in this product.

- Do not expose batteries to flame or excessive heat.

- Do not disassemble.

- Do not short-circuit the terminals by touching them to necklaces, hairpins, or other metal objects.

- Do not expose batteries or the products in which they are inserted to powerful physical shocks.

- Do not step on batteries, pierce them with nails, or strike them with hammers.

Charge only as indicated.

Failure to observe this precaution could result in the batteries leaking, overheating, rupturing, or catching fire.

If battery liquid comes into contact with the eyes, rinse with plenty of clean water and seek immediate medical attention.

Delaying action could result in eye injuries.

Follow the instructions of airline personnel.

Batteries left unattended at high altitudes in an unpressurized environment may leak, overheat, rupture, or catch fire.

⚠ WARNING (Batteries)

Keep batteries out of reach of children.

Should a child swallow a battery, seek immediate medical attention.

Keep batteries out of reach of household pets and other animals. The batteries could leak, overheat, rupture, or catch fire if bitten, chewed, or otherwise damaged by animals.

Do not immerse batteries in water or expose to rain.

Failure to observe this precaution could result in fire or product malfunction. Immediately dry the product with a towel or similar object should it become wet.

Discontinue use immediately should you notice any changes in the batteries, such as discoloration or deformation. Cease charging EN-EL25 rechargeable batteries if they do not charge in the specified period of time.

Failure to observe these precautions could result in the batteries leaking, overheating, rupturing, or catching fire.

When batteries are no longer needed, insulate the terminals with tape. Overheating, rupture, or fire may result should metal objects come into contact with the terminals.

If battery liquid comes into contact with a person's skin or clothing, immediately rinse the affected area with plenty of clean water.

Failure to observe this precaution could result in skin irritation.

Notices

No part of the documentation included with this product may be reproduced, transmitted, transcribed, stored in a retrieval system, or translated into any language in any form, by any means, without Nikon's prior written permission.

Nikon reserves the right to change the appearance and specifications of the hardware and software described in this documentation at any time and without prior notice.

Nikon will not be held liable for any damages resulting from the use of this product.

While every effort has been made to ensure that the information in this documentation is accurate and complete, we would appreciate it were you to bring any errors or omissions to the attention of the Nikon representative in your area (address provided separately).

Notice concerning prohibition of copying or reproduction

Note that simply being in possession of material that has been digitally copied or reproduced by means of a scanner, digital camera, or other device may be punishable by law.

• **Items prohibited by law from being copied or reproduced**

Do not copy or reproduce paper money, coins, securities, government bonds, or local government bonds, even if such copies or reproductions are stamped "Sample". The copying or reproduction of paper money, coins, or securities which are circulated in a foreign country is prohibited.

Unless the prior permission of the government has been obtained, the copying or reproduction of unused postage stamps or post cards issued by the government is prohibited.

The copying or reproduction of stamps issued by the government and of certified documents stipulated by law is prohibited.

• **Caution on certain copies and reproductions**

The government has issued cautions on copies or reproductions of securities issued by private companies (shares, bills, checks, gift certificates, etc.), commuter passes, or coupon tickets, except when a minimum of necessary copies are to be provided for business use by a company. Also, do not copy or reproduce passports issued by the government, licenses issued by public agencies and private groups, ID cards, and tickets, such as passes and meal coupons.

• **Comply with copyright notices**

Under copyright law, photographs or recordings of copyrighted works made with the camera cannot be used without the permission of the copyright holder. Exceptions apply to personal use, but note that even personal use may be restricted in the case of photographs or recordings of exhibits or live performances.

Use only Nikon brand electronic accessories

Nikon cameras are designed to the highest standards and include complex electronic circuitry. Only Nikon brand electronic accessories (including lenses, battery chargers, batteries, AC adapters, and flash accessories) certified by Nikon specifically for use with this Nikon digital camera are engineered and proven to operate within the operational and safety requirements of this electronic circuitry.

The use of non-Nikon electronic accessories could damage the camera and may void your Nikon warranty. The use of third-party rechargeable Li-ion batteries not bearing the Nikon holographic seal shown at right could interfere with normal operation of the camera or result in the batteries overheating, igniting, rupturing, or leaking.

For more information about Nikon brand accessories, contact a local authorized Nikon dealer.

Memory cards

• Memory cards may be hot after use. Observe due caution when removing memory cards from the camera.

• Do not perform the following operations during formatting or while data are being recorded, deleted, or copied to a computer or other device. Failure to observe these precautions could result in loss of data or in damage to the camera or card.

- Do not remove or insert memory cards

- Do not turn the camera off

- Do not remove the battery

• Do not touch the card terminals with your fingers or metal objects.

• Do not use excessive force when handling memory cards. Failure to observe this precaution could damage the card.

• Do not bend or drop memory cards or subject them to strong physical shocks.

• Do not expose memory cards to water, heat, or direct sunlight.

• Do not format memory cards in a computer.

Before taking important pictures

Before taking pictures on important occasions (such as at weddings or before taking the camera on a trip), take a test shot to ensure that the camera is functioning normally. Nikon will not be held liable for damages or lost profits that may result from product malfunction.

Life-long learning

As part of Nikon's "Life-long learning" commitment to ongoing product support and education, continually-updated information is available on-line at the following sites:

• **For users in the U.S.A.:** <https://www.nikonusa.com/>

• **For users in Canada:** <https://www.nikon.ca/>

• **For users in Mexico:** <https://www.nikon.com.mx/>

• **For users in Latin America:** <https://www.nikonamericalatina.com/>

• **For users in Europe:** <https://www.europe-nikon.com/support/>

• **For users in Asia, Oceania, the Middle East, and Africa:** <https://www.nikon-asia.com/>

Visit these sites to keep up-to-date with the latest product information, tips, answers to frequently-asked questions (FAQs), and general advice on digital imaging and photography. Additional information may be available from the Nikon representative in your area. See the following URL for contact information: <https://imaging.nikon.com/>

Notices for customers in Europe

CAUTION: RISK OF EXPLOSION IF BATTERY IS REPLACED BY AN INCORRECT TYPE. DISPOSE OF USED BATTERIES ACCORDING TO THE INSTRUCTIONS.

This symbol indicates that electrical and electronic equipment is to be collected separately.

The following apply only to users in European countries:

• This product is designated for separate collection at an appropriate collection point. Do not dispose of as household waste.

• Separate collection and recycling helps conserve natural resources and prevent negative consequences for human health and the environment that might result from incorrect disposal.

• For more information, contact the retailer or the local authorities in charge of waste management.

This symbol on the battery indicates that the battery is to be collected separately.

The following apply only to users in European countries:

• All batteries, whether marked with this symbol or not, are designated for separate collection at an appropriate collection point. Do not dispose of as household waste.

• For more information, contact the retailer or the local authorities in charge of waste management.

Caring for the camera and battery: Cautions

■ *Battery care*

● **Precautions for use**

• If improperly handled, batteries may rupture or leak, causing the product to corrode. Observe the following precautions when handling batteries:

- Turn the product off before replacing the battery.

- Batteries may be hot after extended use.

- Keep the battery terminals clean.

- Use only batteries approved for use in this equipment.

- Do not short or disassemble batteries or expose them to flame or excessive heat.

- When the battery is not inserted in the camera, insulate the terminals.

- If there is a terminal cover, attach the terminal cover to the battery. If there is no terminal cover, keep the battery separate in a plastic bag or other non-conductive container.

• If the battery is hot, for example immediately after use, wait for it to cool before charging. Attempting to charge the battery while its internal temperature is elevated will impair battery performance, and the battery may not charge or charge only partially.

• The battery will not be used for some time, remove it from the camera for storage. The battery should be stored in a cool, dry location with an ambient temperature of 15 °C to 25 °C (59 °F to 77 °F). Avoid hot or extremely cold locations.

• Batteries should be charged within six months of use. During long periods of disuse, charge the battery once every six months before returning it to a cool location for storage.

• Remove the battery from the camera when not in use. The camera and charger draw minute amounts of charge even when off and could draw the battery down to the point that it will no longer function.

• Do not use the battery at ambient temperatures below 0 °C (32 °F) or above 40 °C (104 °F). Failure to observe this precaution could damage the battery or impair its performance. Charge the battery indoors at ambient temperatures of 5 °C–35 °C (41 °F–95 °F). The battery will not charge if its temperature is below 0 °C (32 °F) or above 60 °C (140 °F).

• Capacity may be reduced and charging times increase at battery temperatures from 0 °C (32 °F) to 15 °C (59 °F) and from 45 °C (113 °F) to 60 °C (140 °F).

• Batteries in general exhibit a drop in charging capacity at low ambient temperatures.

• Batteries in general exhibit a drop in available capacity at low ambient temperatures. The change in capacity with temperature is reflected in the camera battery-level display. As a result, the battery display may show a drop in capacity as the temperature drops, even if the battery is fully charged.

• Batteries may be hot after use. Observe due caution when removing batteries from the camera.

● **Charge batteries before use**

Charge the battery before use. The supplied battery is not fully charged at shipment.

● **Ready spare batteries**

Before taking photographs, ready a spare battery and keep it fully charged. Depending on your location, it may be difficult to purchase replacement batteries on short notice.

● **Have fully-charged spare batteries ready on cold days**

Partially-charged batteries may not function on cold days. In cold weather, charge one battery before use and keep another in a warm place, ready to be exchanged as necessary. Once warmed, a cold battery may recover some of its charge.

● **Battery level**

• Turning the camera on or off repeatedly when the battery is fully discharged will shorten battery life. Batteries that have been fully discharged must be charged before use.

• A marked drop in the time a fully charged battery retains its charge when used at room temperature indicates that it requires replacement. Purchase a new rechargeable battery.

● **Do not attempt to charge fully-charged batteries**

Continuing to charge the battery after it is fully charged can impair battery performance.

● **Recycling used batteries**

Recycle rechargeable batteries in accord with local regulations, being sure to first insulate the terminals with tape.

● **Turn the product off before removing the battery**
Removing the battery while the camera is on could damage the product. Particular care should be taken not to remove or disconnect the power source while images are being recorded or deleted.

● **Notes on the monitor**

• The monitor is constructed with extremely high precision; at least 99.99% of pixels are effective, with no more than 0.01% being missing or defective. Hence while the monitor may contain pixels that are always lit (white, red, blue, or green) or always off (black), this is not a malfunction. Images recorded with the device are unaffected. Your understanding is requested.

• Images in the monitor may be difficult to see in a bright light.

• Do not apply pressure to the monitor. The monitor could malfunction or suffer damage. Dust or lint on the monitor can be removed with a blower.

Stains can be removed by wiping the monitor lightly with a soft cloth or chamois leather. Should the monitor break, care should be taken to avoid injury from broken glass. Be careful that liquid crystal from the monitor does not touch the skin or enter the eyes or mouth.

• The display may rapidly flicker on and off during burst photography. Watching the flickering display could cause you to feel unwell.

Discontinue use until your condition improves.

● **Bright lights and back-lit subjects**

Noise in the form of lines may in rare cases appear in pictures that include bright lights or back-lit subjects.

Disposing of data storage devices

Please note that deleting images or formatting memory cards or other data storage devices does not completely erase the original image data. Deleted files can sometimes be recovered from discarded storage devices using commercially available software, potentially resulting in the malicious use of personal image data. Ensuring the privacy of such data is the user's responsibility.

Before discarding a data storage device or transferring ownership to another person, erase all data using commercial deletion software, or format the device and then completely refill it with images containing no private information (for example, pictures of empty sky). Care should be taken to avoid injury when physically destroying data storage devices. Before discarding the camera or transferring ownership to another person, you should also use the **[Reset all settings]** item in the camera setup menu to delete network settings and other personal information.

Trademarks and licenses

• The SD, SDHC, and SDXC logos are trademarks of SD-3C, LLC. Windows is either a registered trademark or a trademark of Microsoft Corporation in the United States and/or other countries.
• Apple®, App Store®, the Apple logos, iPhone®, iPad®, Mac, and macOS are trademarks of Apple Inc. registered in the U.S. and/or other countries.
• Android, Google Play and the Google Play logo are trademarks of Google LLC. The Android robot is reproduced or modified from work created and shared by Google and used according to terms described in the Creative Commons 3.0 Attribution License.

• iOS is a trademark or registered trademark of Cisco Systems, Inc., in the United States and/or other countries and is used under license.

• HDMI and the HDMI logo and High-Definition Multimedia Interface are trademarks or registered trademarks of HDMI Licensing, LLC.

• The Bluetooth® word mark and logo are registered trademarks owned by Bluetooth SIG, Inc., and any use of such marks by Nikon is under license.

• Wi-Fi and the Wi-Fi logo are trademarks or registered trademarks of the Wi-Fi Alliance.

• All other trade names mentioned in this document or the other documentation provided with your Nikon product are trademarks or registered trademarks of their respective holders.

• Use of the Made for Apple badge means that an accessory has been designed to connect specifically to the Apple products identified in the badge, and has been certified by the developer to meet Apple performance standards. Apple is not responsible for the operation of this device or its compliance with safety and regulatory standards. Please note that the use of this accessory with an Apple product may affect wireless performance.

• The software for this product includes open-source software copyrighted by third parties. The terms of the licenses for this open-source software may be found in the *Reference Guide*.

<https://downloadcenter.nikonimglib.com/>

Bluetooth and Wi-Fi (wireless LAN)

This product is controlled by the United States Export Administration Regulations (EAR). The permission of the United States government is not required for export to countries other than the following, which as of this writing are subject to embargo or special controls: Cuba, Iran, North Korea, Sudan, and Syria (list subject to change).

The use of wireless devices may be prohibited in some countries or regions. Contact a Nikon-authorized service representative before using the wireless features of this product outside the country of purchase.

The Bluetooth transmitter in this device operates in the 2.4 GHz band.

Notice for customers in Europe and in countries complying with the Radio Equipment Directive

Hereby, Nikon Corporation declares that the radio equipment type Z 30 is in compliance with Directive 2014/53/EU.

The full text of the EU declaration of conformity is available at the following internet address:

https://imaging.nikon.com/support/pdf/DoC_N2121.pdf

Wi-Fi

• **Operating frequency:**
- 2412–2462 MHz (channel 11): Africa, Asia, Bolivia, Europe, and Oceania)
- 2412–2462 MHz (channel 11), 5180–5825 MHz (5180–5580 MHz, 5660–5700 MHz, and 5745–5825 MHz) (U.S.A., Canada, Mexico)
- 2412–2462 MHz (channel 11), 5180–5805 MHz (5180–5320 MHz and 5745–5805 MHz) (other countries in the Americas)

• **Maximum output power (EIRP):**
- 2.4 GHz band: 4.5 dBm
- 5 GHz band: 6.8 dBm (countries in the Americas)

Bluetooth

• **Operating frequency:**
- Bluetooth: 2402–2480 MHz
- Bluetooth Low Energy: 2402–2480 MHz

• **Maximum output power (EIRP):**
- Bluetooth: –1.0 dBm
- Bluetooth Low Energy: –2.5 dBm

Notice for customers in the UK

Hereby, Nikon Corporation declares that the radio equipment type Z 30 is in compliance with Radio Equipment Regulations 2017.

The full text of the UKCA declaration of conformity is available at the following internet address:
https://imaging.nikon.com/support/pdf/UKCA_DoC_N2121.pdf

Wi-Fi

• **Operating frequency:**
- 2412–2462 MHz (channel 11)