

Nikon

DIGITAL CAMERA

D7500

User's Manual

- Read this manual thoroughly before using the camera.
- To ensure proper use of the camera, be sure to read "For Your Safety" (page xii).
- After reading this manual, keep it in a readily accessible place for future reference.

En



Get SnapBridge Now!

Use SnapBridge to control the camera remotely from your smartphone or tablet (smart device) and download pictures from the camera.

Download It Free Today!

SnapBridge is available free-of-charge from the Apple App Store®, on Google Play™, and from the following website:

<http://snapbridge.nikon.com>

Visit the Nikon website for the latest SnapBridge news.



Download on the
App Store



GET IT ON
Google Play

Connect Your Camera and Smart Device

Follow the steps below to pair your camera and smart device:

- 1** Launch the connection wizard on your camera.



- 2** Tap the camera name on your smart device.



- 3** Press the camera **OK** button and tap **Pair** on the smart device (the display varies with the device and operating system).

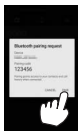

See page 28 for more information on pairing. 

Enhance your imaging experience with SnapBridge.



Download photos from your camera to your smart device via an “always on” connection, making online photo sharing easier and less stressful than ever.

NIKON IMAGE SPACE

Upload photos and thumbnails to the NIKON IMAGE SPACE cloud storage service.



Enrich your imaging experience by using SnapBridge to:

- Control the camera remotely
- Add credits (any two of copyright information, comments, text, or logos) directly to your photos
- Automatically upload the time and location from your smart device to your camera
- Receive camera firmware updates



More on SnapBridge

For more information, use the online help feature in the SnapBridge app.

To get the most from your camera, please be sure to read all instructions thoroughly and keep them where they will be read by all who use the product.

Symbols and Conventions

To make it easier to find the information you need, the following symbols and conventions are used:



This icon marks cautions; information that should be read before use to prevent damage to the camera.



This icon marks notes; information that should be read before using the camera.



This icon marks references to other sections in this manual.

Menu items, options, and messages displayed in the camera monitor are shown in **bold**. Camera and smart device menus and dialogs may differ from those shown here.

Throughout this manual, smartphones and tablets are referred to as “smart devices”.

Camera Settings

The explanations in this manual assume that default settings are used.

Nikon Manual Viewer 2



Install the Nikon Manual Viewer 2 app on your smartphone or tablet to view Nikon digital camera manuals, anytime, anywhere. Nikon Manual Viewer 2 can be downloaded free of charge from the App Store and on Google Play. Download of the app and any product manuals requires an Internet connection, for which fees may be levied by your phone or Internet service provider.

For Your Safety

Before using the camera for the first time, read the safety instructions in “For Your Safety” (📖 xii).

Nikon User Support for India and Australia

Contact a Nikon representative for technical assistance with the operation of your Nikon product or products. For information on the Nikon representatives in your area, visit <http://www.nikon-asia.com/support>.

■ ■ The Menu Guide

For more information on menu options and subjects such as how to connect the camera to a printer or television, download the camera *Menu Guide* from the Nikon website as described below. The *Menu Guide* is in pdf format and can be viewed using Adobe Reader or Adobe Acrobat Reader.

- 1 On your computer, launch a web browser and open the Nikon manual download site at <http://downloadcenter.nikonimglib.com/>
- 2 Navigate to the page for the desired product and download the manual.



Package Contents

Be sure all items listed here were included with your camera.

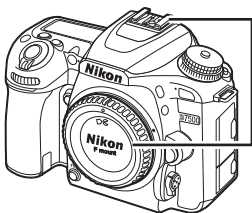

- DK-28 rubber eyecup (☞ 90; comes attached to camera)



- BF-1B body cap (☞ 24, 287)

- D7500 camera (☞ 1)

- EN-EL15a rechargeable Li-ion battery with terminal cover (☞ 19, 21)
- MH-25a battery charger (comes with either an AC wall adapter or power cable of a type and shape that varies with the country or region of sale; ☞ 19)
- DK-5 eyepiece cap (☞ 90)
- AN-DC3 BK strap (☞ 19)
- UC-E20 USB cable
- Warranty
- User's Manual (this guide)

Purchasers of the lens kit option should confirm that the package also includes a lens. *Memory cards are sold separately.* Cameras purchased in Japan display menus and messages in English and Japanese only; other languages are not supported. We apologize for any inconvenience this may cause.

ViewNX-i and Capture NX-D Computer Software

Use ViewNX-i to fine-tune photos or to copy pictures to a computer for viewing, or Capture NX-D to fine-tune pictures that have been copied to a computer and to convert NEF (RAW) images to other formats.

These applications are available for download from:

<http://downloadcenter.nikonimglib.com/>

You can also visit this website for the latest information on Nikon software, including system requirements.

Table of Contents

Package Contents	iv
For Your Safety	xii
Notices.....	xvi
Introduction	1
<hr/>	
Getting to Know the Camera	1
The Camera Body.....	1
The Mode Dial.....	6
The Control Panel	8
The Viewfinder.....	9
The Diopter Adjustment Control	11
Using the Tilting Monitor.....	12
Using the Touch Screen	14
The Multi Selector.....	18
First Steps	19
<hr/>	
Attach the Camera Strap.....	19
Charge the Battery	19
Insert the Battery and a Memory Card	21
Attach a Lens.....	24
Turn the Camera On	26
Connecting Using SnapBridge	28
<hr/>	
What SnapBridge Can Do for You	29
What You'll Need.....	30
Readying the Smart Device	31
Pairing and Connecting	32
Connection Tips.....	37
The Wi-Fi Prompt (iOS Only)	37

More on Pairing and Connecting	39
“Unable to Connect.”	39
Pairing Problems	39
Downloading Pictures	40
Tutorial	41
<hr/>	
Camera Menus: An Overview	41
Using Camera Menus.....	42
The Battery Level and Number of Exposures Remaining ...	46
Basic Photography and Playback	48
<hr/>	
“Point-and-Shoot” Photography (AUTO and Modes).....	48
Tips for Live View.....	56
Basic Playback	59
Deleting Unwanted Photographs.....	60
Matching Settings to the Subject or Situation (Scene Mode)	61
<hr/>	
Choosing a Scene Mode	61
Special Effects	64
<hr/>	
Choosing Special Effects	64
Options Available in Live View	66
P, S, A, and M Modes	72
<hr/>	
Choosing a Mode.....	72
P: Programmed Auto.....	73
S: Shutter-Priority Auto.....	74
A: Aperture-Priority Auto	75
M: Manual	76
Long Time-Exposures (M Mode Only)	79

User Settings: U1 and U2 Modes	83
Saving User Settings	83
Recalling User Settings	84
Resetting User Settings	85
Release Mode	86
Choosing a Release Mode.....	86
Self-Timer Mode (⌚)	89
Mirror up Mode (MUP)	91
Image Recording Options	93
Image Area	93
Image Quality.....	97
Image Size.....	99
Focus	100
Autofocus	100
Autofocus Mode.....	100
AF-Area Mode	103
Focus Lock.....	111
Manual Focus	115
ISO Sensitivity	118
ISO Sensitivity Settings	118
Auto ISO Sensitivity Control	120
Exposure	123
Metering	123
Autoexposure Lock.....	125
Exposure Compensation	127

White Balance	130
<hr/>	
White Balance Options	130
Fine-Tuning White Balance	134
Choosing a Color Temperature.....	137
Preset Manual	139
Viewfinder Photography	139
Live View (Spot White Balance).....	143
Managing Presets.....	146
Image Enhancement	148
<hr/>	
Picture Controls	148
Selecting a Picture Control	148
Modifying Picture Controls.....	150
Preserving Detail in Highlights and Shadows.....	153
Active D-Lighting	153
High Dynamic Range (HDR)	155
Flash Photography	159
<hr/>	
Using the Built-in Flash	159
Auto Pop-up Modes	159
Manual Pop-up Modes	161
Flash Control Mode	164
Flash Compensation	167
FV Lock	169
Viewing Information for the Built-in Flash	172
Optional Flash Units.....	174
Remote Control Photography	175
<hr/>	
Using an Optional ML-L3 Remote Control.....	175







Recording and Viewing Movies	179
<hr/>	
Recording Movies	179
Using the i Button	183
The Live View Display: Movies	185
Viewing and Hiding Indicators	187
Frame Size, Frame Rate, and Movie Quality	188
Indices	189
The Movie Crop	190
Taking Photos in Movie Mode	191
Viewing Movies	194
Editing Movies	196
Trimming Movies	196
Saving Selected Frames	200
Other Shooting Options	201
<hr/>	
The info Button (Viewfinder Photography)	201
The i Button	205
Two-Button Reset: Restoring Default Settings	206
Bracketing	209
Location Data	223
More on Playback	225
<hr/>	
Viewing Images	225
Full-Frame Playback	225
Thumbnail Playback	225
Calendar Playback	226
Using the Touch Screen	228
The i Button	230
Photo Information	231
Taking a Closer Look: Playback Zoom	240

Protecting Photographs from Deletion	242
Rating Pictures	243
Rating Individual Pictures	243
Rating Multiple Pictures.....	244
Selecting Photos for Upload.....	245
Selecting Individual Photos.....	245
Selecting Multiple Photos	246
Deleting Photographs	247
During Playback.....	247
The Playback Menu	248

Menu List 250

Camera Menus

More information on camera menus is available in a *Menu Guide* that can be downloaded from the Nikon website (📖 iii).

 The Playback Menu: <i>Managing Images</i>	250
 The Photo Shooting Menu: <i>Photo Shooting Options</i>	252
 The Movie Shooting Menu: <i>Movie Shooting Options</i>	257
 Custom Settings: <i>Fine-Tuning Camera Settings</i>	260
 The Setup Menu: <i>Camera Setup</i>	268
 The Retouch Menu: <i>Creating Retouched Copies</i>	275
 My Menu/📄 Recent Settings	278

Technical Notes 279

Compatible Lenses	279
Compatible CPU Lenses.....	279
Compatible Non-CPU Lenses.....	285
Other Accessories	287

Caring for the Camera	288
Storage	288
Cleaning	288
Image Sensor Cleaning.....	289
Caring for the Camera and Battery: Cautions.....	296
Troubleshooting.....	301
Battery/Display	301
Shooting (All Modes).....	302
Shooting (P, S, A, M)	305
Playback	306
Bluetooth and Wi-Fi (Wireless Networks)	308
Miscellaneous	308
Error Messages.....	309
Specifications.....	315
AF-S DX NIKKOR 18–140mm f/3.5–5.6G ED VR Lenses	329
AF-S DX NIKKOR 18–200mm f/3.5–5.6G ED VR II	
Lenses	336
Approved Memory Cards	346
Memory Card Capacity.....	347
Battery Life	349
Index.....	351

For Your Safety

To prevent damage to property or injury to yourself or to others, read “For Your Safety” in its entirety before using this product.

Keep these safety instructions where all those who use this product will read them.

⚠ DANGER: Failure to observe the precautions marked with this icon carries a high risk of death or severe injury.

⚠ WARNING: Failure to observe the precautions marked with this icon could result in death or severe injury.

⚠ CAUTION: Failure to observe the precautions marked with this icon could result in injury or property damage.



WARNING

• Do not use while walking or operating a motor vehicle.

Failure to observe this precaution could result in accidents or other injury.

• Do not disassemble or modify this product. Do not touch internal parts that become exposed as the result of a fall or other accident.

Failure to observe these precautions could result in electric shock or other injury.

• Should you notice any abnormalities such as the product producing smoke, heat, or unusual odors, immediately disconnect the battery or power source.

Continued operation could result in fire, burns or other injury.

• Keep dry. Do not handle with wet hands. Do not handle the plug with wet hands.

Failure to observe these precautions could result in fire or electric shock.

• Do not let your skin remain in prolonged contact with this product while it is on or plugged in.

Failure to observe this precaution could result in low-temperature burns.

• Do not use this product in the presence of flammable dust or gas such as propane, gasoline or aerosols.

Failure to observe this precaution could result in explosion or fire.

- **Do not directly view the sun or other bright light source through the lens or camera.**

Failure to observe this precaution could result in visual impairment.

- **Do not aim the flash or AF-assist illuminator at the operator of a motor vehicle.**

Failure to observe this precaution could result in accidents.

- **Keep this product out of reach of children.**

Failure to observe this precaution could result in injury or product malfunction. In addition, note that small parts constitute a choking hazard. Should a child swallow any part of this product, seek immediate medical attention.

- **Do not entangle, wrap or twist the straps around your neck.**

Failure to observe this precaution could result in accidents.

- **Do not use batteries, chargers, or AC adapters not specifically designated for use with this product. When using batteries, chargers, and AC adapters designated for use with this product, do not:**

- **Damage, modify, forcibly tug or bend the cords or cables, place them under heavy objects, or expose them to heat or flame.**
- **Use travel converters or adapters designed to convert from one voltage to another or with DC-to-AC inverters.**

Failure to observe these precautions could result in fire or electric shock.

- **Do not handle the plug when charging the product or using the AC adapter during thunderstorms.**

Failure to observe this precaution could result in electric shock.

- **Do not handle with bare hands in locations exposed to extremely high or low temperatures.**

Failure to observe this precaution could result in burns, or frostbite.



CAUTION

- **Do not leave the lens pointed at the sun or other strong light sources.**

Light focused by the lens could cause fire or damage to product's internal parts. When shooting backlit subjects, keep the sun well out of the frame. Sunlight focused into the camera when the sun is close to the frame could cause fire.

- **Turn this product off when its use is prohibited. Disable wireless features when the use of wireless equipment is prohibited.**

The radio-frequency emissions produced by this product could interfere with equipment onboard aircraft or in hospitals or other medical facilities.

- **Remove the battery and disconnect the AC adapter if this product will not be used for an extended period.**

Failure to observe this precaution could result in fire or product malfunction.

- **Do not touch moving parts of the lens or other moving parts.**

Failure to observe this precaution could result in injury.

- **Do not fire the flash in contact with or in close proximity to the skin or objects.**

Failure to observe this precaution could result in burns or fire.

- **Do not leave the product where it will be exposed to extremely high temperatures, for an extended period such as in an enclosed automobile or in direct sunlight.**

Failure to observe this precaution could result in fire or product malfunction.



DANGER (Batteries)

- **Do not mishandle batteries.**

Failure to observe the following precautions could result in the batteries leaking, overheating, rupturing, or catching fire:

- Use only rechargeable batteries approved for use in this product.
 - Do not expose batteries to flame or excessive heat.
 - Do not disassemble.
 - Do not short-circuit the terminals by touching them to necklaces, hairpins, or other metal objects.
 - Do not expose batteries or the products in which they are inserted to powerful physical shocks.
-

- **Do not attempt to recharge EN-EL15a rechargeable batteries using chargers not specifically designated for this purpose.**

Failure to observe this precaution could result in the batteries leaking, overheating, rupturing, or catching fire.

- **If battery liquid comes into contact with the eyes, rinse with plenty of clean water and seek immediate medical attention.**

Delaying action could result in eye injuries.



WARNING (Batteries)

- **Keep batteries out of reach of children.**

Should a child swallow a battery, seek immediate medical attention.

- **Do not immerse batteries in water or expose to rain.**

Failure to observe this precaution could result in fire or product malfunction. Immediately dry the product with a towel or similar object should it become wet.

- **Discontinue use immediately should you notice any changes in the batteries, such as discoloration or deformation. Cease charging EN-EL15a rechargeable batteries if they do not charge in the specified period of time.**

Failure to observe these precautions could result in the batteries leaking, overheating, rupturing, or catching fire.

- **Prior to disposal, insulate battery terminals with tape.**

Overheating, rupture, or fire may result should metal objects come into contact with the terminals. Recycle or dispose of batteries in accord with local regulations.

- **If battery liquid comes into contact with a person's skin or clothing, immediately rinse the affected area with plenty of clean water.**

Failure to observe this precaution could result in skin irritation.

Notices

- No part of the manuals included with this product may be reproduced, transmitted, transcribed, stored in a retrieval system, or translated into any language in any form, by any means, without Nikon's prior written permission.
- Nikon reserves the right to change the appearance and specifications of the hardware and software described in these manuals at any time and without prior notice.
- Nikon will not be held liable for any damages resulting from the use of this product.
- While every effort has been made to ensure that the information in these manuals is accurate and complete, we would appreciate it were you to bring any errors or omissions to the attention of the Nikon representative in your area (address provided separately).

Notice for Customers in Canada

CAN ICES-3 B / NMB-3 B

Notices for Customers in Europe

CAUTION: RISK OF EXPLOSION IF BATTERY IS REPLACED BY AN INCORRECT TYPE. DISPOSE OF USED BATTERIES ACCORDING TO THE INSTRUCTIONS.

This symbol indicates that electrical and electronic equipment is to be collected separately.



This symbol on the battery indicates that the battery is to be collected separately.



The following apply only to users in European countries:

- This product is designated for separate collection at an appropriate collection point. Do not dispose of as household waste.
- Separate collection and recycling helps conserve natural resources and prevent negative consequences for human health and the environment that might result from incorrect disposal.
- For more information, contact the retailer or the local authorities in charge of waste management.

The following apply only to users in European countries:

- All batteries, whether marked with this symbol or not, are designated for separate collection at an appropriate collection point. Do not dispose of as household waste.
- For more information, contact the retailer or the local authorities in charge of waste management.

Notices for Customers in the U.S.A.

The Battery Charger

IMPORTANT SAFETY INSTRUCTIONS—SAVE THESE INSTRUCTIONS

DANGER—TO REDUCE THE RISK OF FIRE OR ELECTRIC SHOCK, CAREFULLY FOLLOW THESE INSTRUCTIONS

For connection to a supply not in the U.S.A., use an attachment plug adapter of the proper configuration for the power outlet if needed. This power unit is intended to be correctly oriented in a vertical or floor mount position.

Federal Communications Commission (FCC) Radio Frequency Interference Statement

This equipment has been tested and found to comply with the limits for a Class B digital device, pursuant to Part 15 of the FCC rules. These limits are designed to provide reasonable protection against harmful interference in a residential installation. This equipment generates, uses, and can radiate radio frequency energy and, if not installed and used in accordance with the instructions, may cause harmful interference to radio communications. However, there is no guarantee that interference will not occur in a particular installation. If this equipment does cause harmful interference to radio or television reception, which can be determined by turning the equipment off and on, the user is encouraged to try to correct the interference by one or more of the following measures:

- Reorient or relocate the receiving antenna.
- Increase the separation between the equipment and receiver.
- Connect the equipment into an outlet on a circuit different from that to which the receiver is connected.
- Consult the dealer or an experienced radio/television technician for help.



Nikon
D7500

CAUTIONS

Modifications

The FCC requires the user to be notified that any changes or modifications made to this device that are not expressly approved by Nikon Corporation may void the user's authority to operate the equipment.

Interface Cables

Use the interface cables sold or provided by Nikon for your equipment. Using other interface cables may exceed the limits of Class B Part 15 of the FCC rules.

Nikon Inc., 1300 Walt Whitman Road,
Melville, New York 11747-3064, U.S.A.
Tel.: 631-547-4200

Power Cable

At voltages over AC 125 V (U.S.A. only): The power cable must be rated for the voltage in use, be at least AWG no. 18 gauge, and have SVG insulation or better with a NEMA 6P-15 plug rated for AC 250 V 15 A.

Notice Concerning Prohibition of Copying or Reproduction

Note that simply being in possession of material that has been digitally copied or reproduced by means of a scanner, digital camera, or other device may be punishable by law.

• Items prohibited by law from being copied or reproduced

Do not copy or reproduce paper money, coins, securities, government bonds, or local government bonds, even if such copies or reproductions are stamped "Sample."

The copying or reproduction of paper money, coins, or securities which are circulated in a foreign country is prohibited.

Unless the prior permission of the government has been obtained, the copying or reproduction of unused postage stamps or post cards issued by the government is prohibited.

The copying or reproduction of stamps issued by the government and of certified documents stipulated by law is prohibited.

• Cautions on certain copies and reproductions

The government has issued cautions on copies or reproductions of securities issued by private companies (shares, bills, checks, gift certificates, etc.), commuter passes, or coupon tickets, except when a minimum of necessary copies are to be provided for business use by a company. Also, do not copy or reproduce passports issued by the government, licenses issued by public agencies and private groups, ID cards, and tickets, such as passes and meal coupons.

• Comply with copyright notices

Under copyright law, photographs or recordings of copyrighted works made with the camera can not be used without the permission of the copyright holder. Exceptions apply to personal use, but note that even personal use may be restricted in the case of photographs or recordings of exhibits or live performances.

Disposing of Data Storage Devices

Please note that deleting images or formatting memory cards or other data storage devices does not completely erase the original image data. Deleted files can sometimes be recovered from discarded storage devices using commercially available software, potentially resulting in the malicious use of personal image data. Ensuring the privacy of such data is the user's responsibility.

Before discarding a data storage device or transferring ownership to another person, erase all data using commercial deletion software, or format the device and then completely refill it with images containing no private information (for example, pictures of empty sky). Care should be taken to avoid injury when physically destroying data storage devices.

Before discarding the camera or transferring ownership to another person, you should also use the **Reset all settings** option in the camera setup menu to delete any personal network information.

AVC Patent Portfolio License

THIS PRODUCT IS LICENSED UNDER THE AVC PATENT PORTFOLIO LICENSE FOR THE PERSONAL AND NON-COMMERCIAL USE OF A CONSUMER TO (i) ENCODE VIDEO IN COMPLIANCE WITH THE AVC STANDARD ("AVC VIDEO") AND/OR (ii) DECODE AVC VIDEO THAT WAS ENCODED BY A CONSUMER ENGAGED IN A PERSONAL AND NON-COMMERCIAL ACTIVITY AND/OR WAS OBTAINED FROM A VIDEO PROVIDER LICENSED TO PROVIDE AVC VIDEO. NO LICENSE IS GRANTED OR SHALL BE IMPLIED FOR ANY OTHER USE. ADDITIONAL INFORMATION MAY BE OBTAINED FROM MPEG LA, L.L.C. SEE <http://www.mpegla.com>

Use Only Nikon Brand Electronic Accessories

Nikon cameras are designed to the highest standards and include complex electronic circuitry. Only Nikon brand electronic accessories (including chargers, batteries, AC adapters, and flash accessories) certified by Nikon specifically for use with this Nikon digital camera are engineered and proven to operate within the operational and safety requirements of this electronic circuitry.

The use of non-Nikon electronic accessories could damage the camera and may void your Nikon warranty. The use of third-party rechargeable Li-ion batteries not bearing the Nikon holographic seal shown at right could interfere with normal operation of the camera or result in the batteries overheating, igniting, rupturing, or leaking.

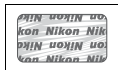

For more information about Nikon brand accessories, contact a local authorized Nikon dealer.

Use Only Nikon Brand Accessories

Only Nikon brand accessories certified by Nikon specifically for use with your Nikon digital camera are engineered and proven to operate within its operational and safety requirements. THE USE OF NON-NIKON ACCESSORIES COULD DAMAGE YOUR CAMERA AND MAY VOID YOUR NIKON WARRANTY.

Before Taking Important Pictures

Before taking pictures on important occasions (such as at weddings or before taking the camera on a trip), take a test shot to ensure that the camera is functioning normally. Nikon will not be held liable for damages or lost profits that may result from product malfunction.

Life-Long Learning

As part of Nikon's "Life-Long Learning" commitment to ongoing product support and education, continually-updated information is available online at the following sites:

- **For users in the U.S.A.:** <http://www.nikonusa.com/>
- **For users in Europe and Africa:** <http://www.europe-nikon.com/support/>
- **For users in Asia, Oceania, and the Middle East:** <http://www.nikon-asia.com/>

Visit these sites to keep up-to-date with the latest product information, tips, answers to frequently-asked questions (FAQs), and general advice on digital imaging and photography. Additional information may be available from the Nikon representative in your area. See the following URL for contact information: <http://imaging.nikon.com/>

■ **Bluetooth and Wi-Fi (Wireless LAN)**

This product is controlled by the United States Export Administration Regulations (EAR). The permission of the United States government is not required for export to countries other than the following, which as of this writing are subject to embargo or special controls: Cuba, Iran, North Korea, Sudan, and Syria (list subject to change).

The use of wireless devices may be prohibited in some countries or regions. Contact a Nikon-authorized service representative before using the wireless features of this product outside the country of purchase.

Notice for Customers in the U.S.A. and Canada

This device complies with part 15 of FCC Rules and Industry Canada's licence-exempt RSSs. Operation is subject to the following two conditions: (1) this device may not cause harmful interference, and (2) this device must accept any interference received, including interference that may cause undesired operation.

FCC WARNING

The FCC requires the user to be notified that any changes or modifications made to this device that are not expressly approved by Nikon Corporation may void the user's authority to operate the equipment.

FCC Radio Frequency Interference Statement

Note: This equipment has been tested and found to comply with the limits for a Class B digital device, pursuant to part 15 of the FCC Rules. These limits are designed to provide reasonable protection against harmful interference in a residential installation. This equipment generates, uses and can radiate radio frequency energy and, if not installed and used in accordance with the instructions, may cause harmful interference to radio communications. However, there is no guarantee that interference will not occur in a particular installation. If this equipment does cause harmful interference to radio or television reception, which can be determined by turning the equipment off and on, the user is encouraged to try to correct the interference by one or more of the following measures:

- Reorient or relocate the receiving antenna.
- Increase the separation between the equipment and receiver.
- Connect the equipment into an outlet on a circuit different from that to which the receiver is connected.
- Consult the dealer or an experienced radio/TV technician for help.

Co-location

This transmitter must not be co-located or operated in conjunction with any other antenna or transmitter.

Nikon Inc., 1300 Walt Whitman Road, Melville, New York 11747-3064, U.S.A.
Tel.: 631-547-4200

FCC/IC RF Exposure Statement

The available scientific evidence does not show that any health problems are associated with using low power wireless devices. There is no proof, however, that these low power wireless devices are absolutely safe. Low power Wireless devices emit low levels of radio frequency energy (RF) in the microwave range while being used. Whereas high levels of RF can produce health effects (by heating tissue), exposure of low-level RF that does not produce heating effects causes no known adverse health effects. Many studies of low-level RF exposures have not found any biological effects. Some studies have suggested that some biological effects might occur, but such findings have not been confirmed by additional research. This product has been tested and found to comply with FCC/IC radiation exposure limits set forth for an uncontrolled environment and meets the FCC radio frequency (RF) Exposure Guidelines and RSS-102 of the IC radio frequency (RF) Exposure rules. Please refer to the SAR test report that was uploaded to FCC website.

Notices for Customers in Europe

Hereby, Nikon Corporation declares that the radio equipment type D7500 is in compliance with Directive 2014/53/EU.



The full text of the EU declaration of conformity is available at the following internet address: http://imaging.nikon.com/support/pdf/DoC_D7500.pdf.

Notice for Customers in Singapore

Trade Name: Nikon Model: D7500
--

This device complies with radio-frequency regulations. The content of certification labels not affixed to the device is given below.

Complies with IMDA Standards DA103423
--

Security

Although one of the benefits of this product is that it allows others to freely connect for the wireless exchange of data anywhere within its range, the following may occur if security is not enabled:

- **Data theft:** Malicious third-parties may intercept wireless transmissions to steal user IDs, passwords, and other personal information.
- **Unauthorized access:** Unauthorized users may gain access to the network and alter data or perform other malicious actions. Note that due to the design of wireless networks, specialized attacks may allow unauthorized access even when security is enabled.
- **Unsecured networks:** Connecting to open networks may result in unauthorized access. Use secure networks only.

Introduction

Getting to Know the Camera

Take a few moments to familiarize yourself with camera controls and displays. You may find it helpful to bookmark this section and refer to it as you read through the rest of the manual.

The Camera Body

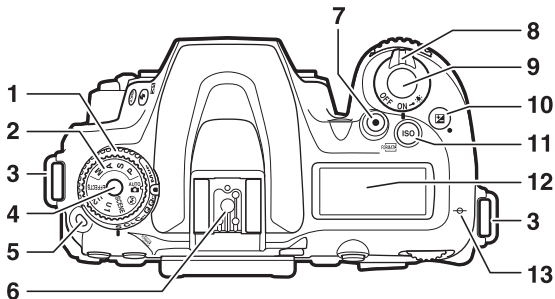

1 Release mode dial	86	7 Movie-record button	179
2 Mode dial	6	8 Power switch	5, 26
3 Eyelet for camera strap	19	9 Shutter-release button	52, 53
4 Mode dial lock release	6	10 button	127, 206
5 Release mode dial lock release	86	11 ISO/ button	118, 268
6 Accessory shoe (for optional flash unit)	287	12 Control panel	8
		13 Focal plane mark ()	116

The Camera Body (Continued)

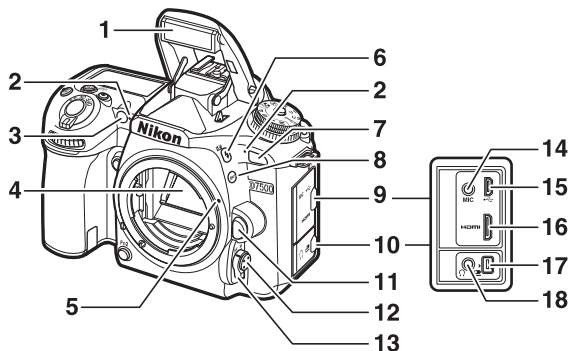

- | | |
|---|---|
| 1 Built-in flash.....55, 159 | 10 Cover for accessory terminal and
headphone connector 184, 223 |
| 2 Stereo microphone 183, 259 | 11 Lens release button25 |
| 3 AF-assist illuminator52, 261 | 12 AF-mode button..... 100, 103 |
| Self-timer lamp89 | 13 Focus-mode selector 100, 115 |
| Red-eye reduction lamp
..... 160, 162 | 14 Connector for external
microphone 184, 287 |
| 4 Mirror.....91, 292 | 15 USB connector 287 |
| 5 Lens mounting mark24 | 16 HDMI connector 287 |
| 6 button 159, 161, 167 | 17 Accessory terminal..... 223, 287 |
| 7 Infrared receiver..... 176 | 18 Headphone connector..... 184 |
| 8 BKT button..... 158, 209 | |
| 9 Cover for USB, HDMI, and external
microphone connectors 287 | |

Close the Connector Cover

Close the connector cover when the connectors are not in use. Foreign matter in the connectors can interfere with data transfer.

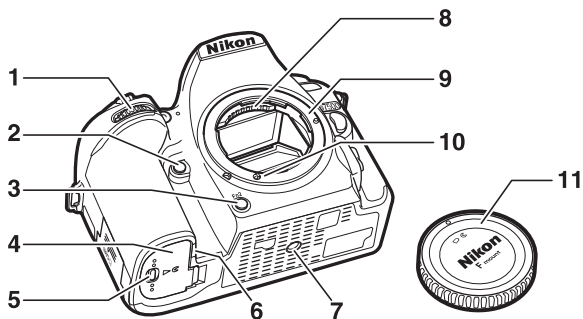

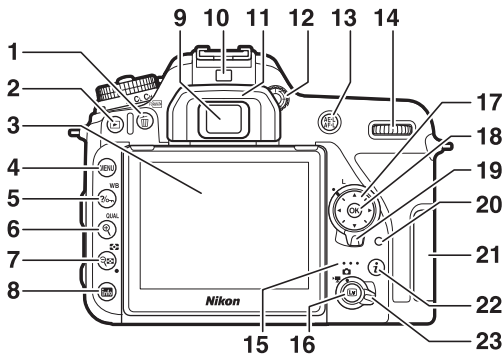

1 Sub-command dial.....	266	6 Power connector cover	
2 Fn1 button	266, 267	7 Tripod socket	
3 Fn2 button	266, 267	8 CPU contacts	
4 Battery-chamber cover	21, 23	9 Lens mount	24, 116
5 Battery-chamber cover latch	21, 23	10 AF coupling	
		11 Body cap	iv, 24, 287

The Camera Body (Continued)



1	/ button.....60, 247, 268	13	button..... 111, 125, 266, 267
2	button59, 225	14	Main command dial..... 266
3	Tilting monitor 12, 14, 269	15	Speaker 5, 194
4	MENU button.....41, 250	16	button49, 179
5	?/WB button42, 130, 242	17	Multi selector..... 18, 42
6	/ QUAL button 57, 97, 99, 240	18	button 18, 42, 266
7	/ button 123, 225	19	Focus selector lock..... 107
8	info button..... 187, 201	20	Memory card access lamp.... 53, 87
9	Viewfinder eyepiece 9, 11	21	Memory card slot cover 21, 23
10	Eye sensor.....13	22	button 183, 205, 230
11	Rubber eyecup.....90	23	Live view selector.....49, 179
12	Diopter adjustment control 11		

LCD Illuminators

Rotating the power switch toward  activates the standby timer and control panel backlight (LCD illuminator), allowing the display to be read in the dark. After the power switch is released, the illuminators will remain lit for a few seconds while the standby timer is active or until the shutter is released or the power switch is rotated toward  again.



*Power
switch*

The Speaker

Do not place the speaker in close proximity to magnetic devices. Failure to observe this precaution could affect the data recorded on the magnetic devices.

The Mode Dial

The camera offers the modes listed below. To choose a mode, press the mode dial lock release and rotate the mode dial.

Mode dial

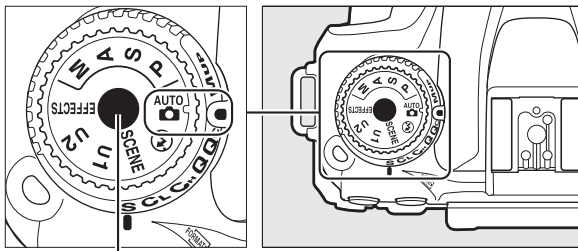

Mode dial lock release

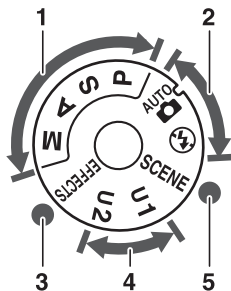

- 1 P, S, A, and M modes:**
 - P**—Programmed auto.....73
 - S**—Shutter-priority auto74
 - A**—Aperture-priority auto ...75
 - M**—Manual.....76
- 2 Auto modes:**
 - AUTO** Auto48
 - Auto (flash off)**.....48
- 3 Special effects modes64**
- 4 U1 and U2 modes.....83**
- 5 Scene modes61**

Non-CPU Lenses

Non-CPU (285) lenses can be used only in mode **M**. Selecting another mode when a non-CPU lens is attached disables the shutter release.

Beeps During Live View

A beep may sound if you rotate the mode dial during live view. This does not indicate an error or malfunction.

The Control Panel

The control panel shows a variety of camera settings when the camera is on. The items shown here appear the first time the camera is turned on; information on other settings can be found in the relevant sections of this manual.

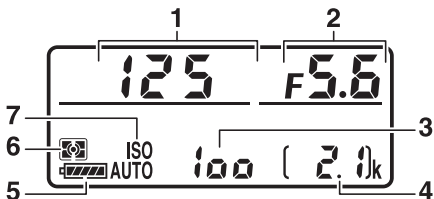

1	Shutter speed	74, 76	6	Metering	123
2	Aperture (f-number)	75, 76	7	ISO sensitivity indicator	118
3	ISO sensitivity	118		Auto ISO sensitivity indicator	121
4	Number of exposures remaining	47			
5	Battery indicator	46			

Camera Off Display

If the camera is turned off with a battery and memory card inserted, the number of exposures remaining will be displayed (some memory cards may in rare cases only display this information when the camera is on).

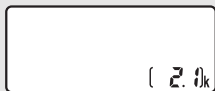

Control panel

The Viewfinder

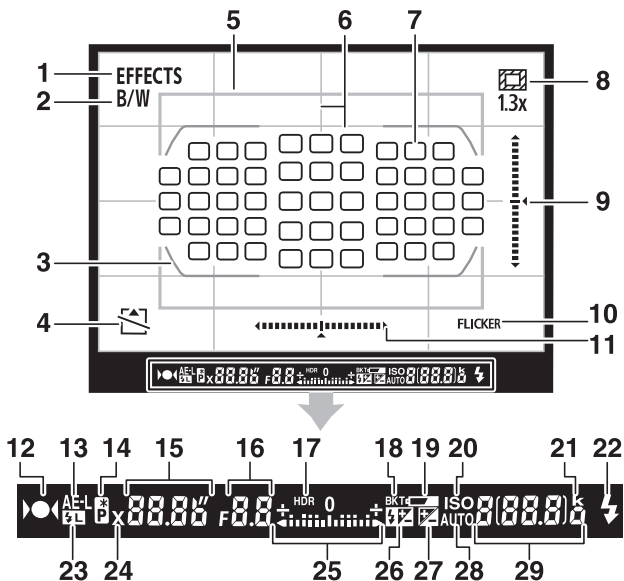

- | | | | |
|---|---|----|-------------------------------------|
| 1 | Special effects mode indicator..... 64 | 7 | Focus points.....52, 107, 260 |
| 2 | Monochrome indicator 64, 148 | 8 | 1.3× DX crop indicator 93, 94 |
| 3 | AF area brackets..... 11, 51 | 9 | Pitch indicator ^{1,2} |
| 4 | “No memory card” indicator 21 | 10 | Flicker detection 255 |
| 5 | 1.3× DX crop 93, 94 | 11 | Roll indicator ^{1,3} |
| 6 | Framing grid (displayed when On is selected for Custom Setting d6, Viewfinder grid display) ...264 | 12 | Focus indicator52, 111, 116 |
| | | 13 | Autoexposure (AE) lock..... 125 |
| | | 14 | Flexible program indicator..... 73 |

15	Shutter speed	74, 76	25	Exposure indicator	77
16	Aperture (f-number)	75, 76		Exposure compensation display	127
17	HDR indicator	156	26	Flash compensation indicator	167
18	Exposure/flash bracketing indicator	210	27	Exposure compensation indicator	128
	WB bracketing indicator	215	28	Auto ISO sensitivity indicator	121
	ADL bracketing indicator	219	29	Number of exposures remaining	47
19	Low battery warning	46		Number of shots remaining before memory buffer fills	87, 347
20	ISO sensitivity indicator	118		ISO sensitivity	118
21	“k” (appears when memory remains for over 1000 exposures)	47		Preset manual white balance recording indicator	139
22	Flash-ready indicator	55, 271			
23	FV lock indicator	169			
24	Flash sync indicator	265			

- 1 Can be displayed by pressing a button to which **Viewfinder virtual horizon** has been assigned using Custom Setting f1 (**Custom control assignment**,  266).
- 2 Functions as a roll indicator when camera is rotated to take pictures in “tall” (portrait) orientation.
- 3 Functions as a pitch indicator when camera is rotated to take pictures in “tall” (portrait) orientation.

Note: Display shown with all indicators lit for illustrative purposes.

No Battery

When the battery is totally exhausted or no battery is inserted, the display in the viewfinder will dim. This is normal and does not indicate a malfunction. The viewfinder display will return to normal when a fully-charged battery is inserted.

The Control Panel and Viewfinder Displays

The brightness of the control panel and viewfinder displays varies with temperature, and the response times of the displays may drop at low temperatures. This is normal and does not indicate a malfunction.

The Diopter Adjustment Control

Rotate the diopter adjustment control until the AF area brackets are in sharp focus. When operating the control with your eye to the viewfinder, be careful not to put your fingers or fingernails in your eye.

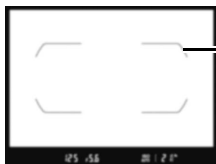
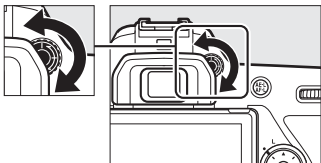

Viewfinder not in focus

AF area brackets

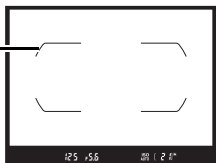

Viewfinder in focus

Using the Tilting Monitor

The monitor can be angled as shown below.

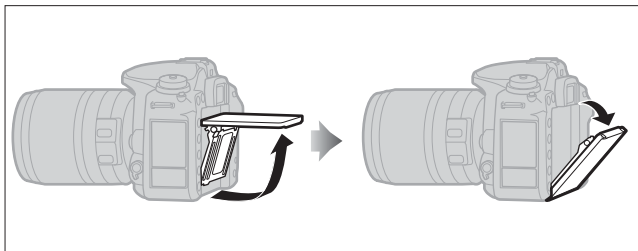

Normal use: The monitor is normally used in storage position.

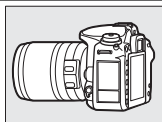

Low-angle shots: Tilt the monitor up to take shots in live view with the camera held low.

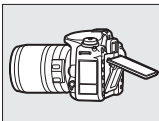

High-angle shots: Tilt the monitor down to take shots in live view with the camera held high.

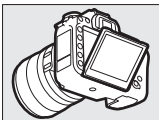

✔ Using the Monitor

Rotate the monitor gently, stopping when you feel resistance. *Do not use force.* Failure to observe these precautions could damage the camera or monitor. If the camera is mounted on a tripod, care should be taken to ensure that the monitor does not contact the tripod.

Do not lift or carry the camera by the monitor. Failure to observe this precaution could damage the camera. If the monitor is not being used to take photographs, return it to the storage position.

The grip and areas of the camera around the monitor may become hot. This does not indicate a malfunction.

Do not allow liquid to contact the inner surface of the monitor. Failure to observe this precaution could cause product malfunction.

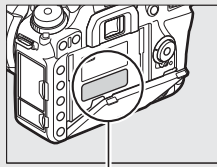

This area becomes particularly hot.

✔ Info Display Auto Off

The eye sensor will automatically turn the information display off if you put your eye to the viewfinder while the standby timer is active. The display will turn on again when you remove your eye from the viewfinder. If desired, you can prevent the information display turning off using the **Info display auto off** option (📖 269) in the setup menu. Note, however, that regardless of the option selected the information display will turn off when the standby timer expires.

Using the Touch Screen

The touch-sensitive monitor supports the following operations:

Flick

Flick a finger a short distance left or right across the monitor.

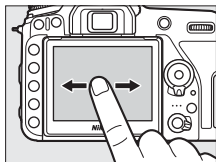

Slide

Slide a finger over the monitor.

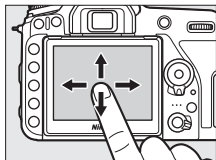

Stretch/Pinch

Place two fingers on the monitor and move them apart or pinch them together.

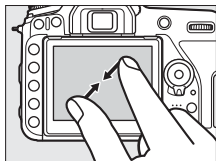
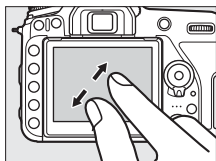

■ ■ Using the Touch Screen

During playback (📖 228), the touch screen can be used to:

- View other images
- Zoom in or out
- View thumbnails
- View movies

During live view, the touch screen can be used to take pictures (touch shutter; 📖 16) or to measure a value for spot white balance (📖 143). The touch screen can also be used for typing (📖 270) or navigating the menus (📖 45).

✔ The Touch Screen

The touch screen responds to static electricity and may not respond when covered with third-party protective films or when touched with fingernails or gloved hands. Do not use excessive force or touch the screen with sharp objects.

✔ Using the Touch Screen

The touch screen may not respond as expected if you attempt to operate it while leaving your palm or another finger resting on it in second location. It may not recognize other gestures if your touch is too soft, your fingers are moved too quickly or too short a distance or do not remain in contact with the screen, or if the movement of the two fingers in a pinch or stretch is not correctly coordinated.

✔ Enabling or Disabling Touch Controls

Touch controls can be enabled or disabled using the **Touch controls** option in the setup menu (📖 271).

✔ See Also

For information on choosing the direction you flick your finger to view other images in full-frame playback, see 📖 > **Touch controls** (📖 271).

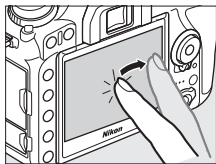

■ ■ Touch Photography (Touch Shutter)

Touch the monitor to focus and lift your finger to take the photograph.



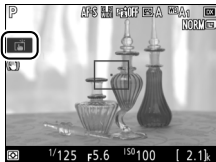

Tap the icon shown in the illustration to choose the operation performed by tapping the monitor in shooting mode. Choose from the following options:







Option	Description
 (Touch shutter/AF: On)	Touch the monitor to position the focus point and focus (autofocus only; the touch shutter can not be used to focus when the focus-mode selector is rotated to M to select manual focus). Focus locks while your finger remains on the monitor; to release the shutter, lift your finger from the screen.
 (Touch AF: On)	As above, except that lifting your finger from the screen does not release the shutter. If subject tracking is active, you can focus on the current subject by tapping the monitor.
 (Touch shutter/AF: Off)	Touch shutter and AF disabled.

For information on touch photography focus, see “Focus” (📖 100).





✔ Taking Pictures Using Touch Shooting Options

The shutter-release button can be used to focus and take pictures even when the  icon is displayed to show that touch shooting options are active. Use the shutter-release button to take photographs in continuous shooting mode ( 86) and during movie recording. Touch shooting options can be used only to take pictures one at a time in continuous shooting mode and can not be used to take photographs during movie recording.

The touch screen can not be used to position the focus point when the focus selector lock is in the L (lock) position ( 107), but it can still be used to select the subject when face-priority AF is selected for AF-area mode ( 103).

In self-timer mode ( 89), focus locks on the selected subject when you touch the monitor and the timer starts when you lift your finger from the screen. At default settings, the shutter is released about 10 s after the timer starts; the delay and number of shots can be changed using Custom Setting c3 (**Self-timer**,  263). If the option selected for **Number of shots** is greater than 1, the camera will automatically take pictures one after the other until the selected number of shots is recorded.

The Multi Selector

In this manual, operations using the multi selector are represented by , , , and  icons.

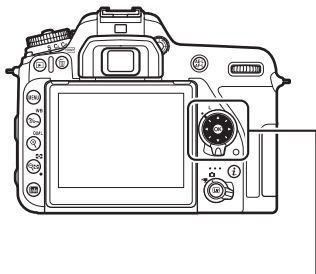

: Press the multi selector up

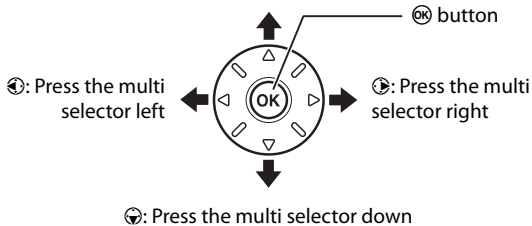

First Steps

Attach the Camera Strap

Attach the strap securely to the camera eyelets.

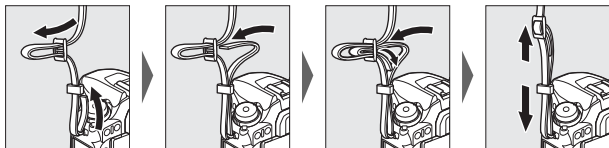

Charge the Battery

Insert the battery and plug the charger in (depending on the country or region, the charger comes with either an AC wall adapter or a power cable). An exhausted battery will fully charge in about two hours and 35 minutes.

- **AC wall adapter:** Insert the AC wall adapter into the charger AC inlet (1). Slide the AC wall adapter latch as shown (2) and rotate the adapter 90° to fix it in place (3). Insert the battery and plug the charger in.

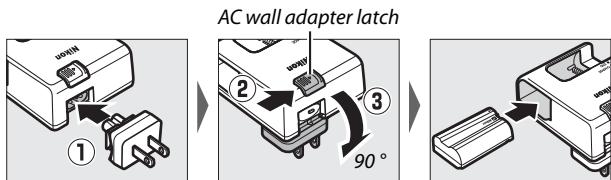

- **Power cable:** After connecting the power cable with the plug in the orientation shown, insert the battery and plug the cable in.

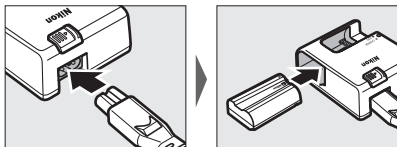

The **CHARGE** lamp will flash while the battery charges.

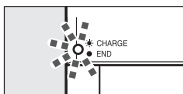

Battery charging

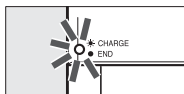

Charging complete

Insert the Battery and a Memory Card

Before inserting or removing the battery or memory cards, confirm that power switch is in the **OFF** position. Insert the battery in the orientation shown, using the battery to keep the orange battery latch pressed to one side. The latch locks the battery in place when the battery is fully inserted.

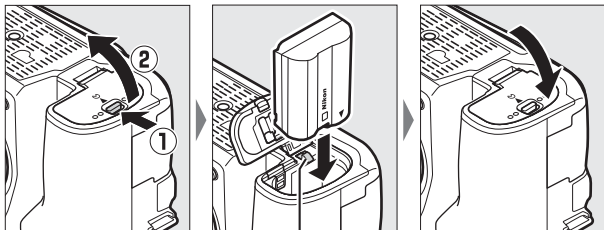

Battery latch

Holding the memory card in the orientation shown, slide it straight into the slot until it clicks into place.

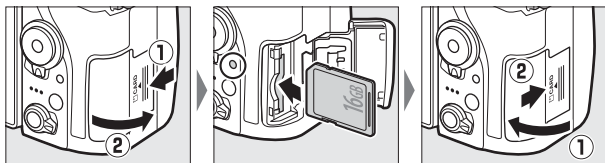

The Battery and Charger

Read and follow the warnings and cautions in "For Your Safety" (📖 xii) and "Caring for the Camera and Battery: Cautions" (📖 296).

✔ Memory Cards

- Memory cards may be hot after use. Observe due caution when removing memory cards from the camera.
- Turn the power off before inserting or removing memory cards. Do not remove memory cards from the camera, turn the camera off, or remove or disconnect the power source during formatting or while data are being recorded, deleted, or copied to a computer. Failure to observe these precautions could result in loss of data or in damage to the camera or card.
- Do not touch the card terminals with your fingers or metal objects.
- Do not bend, drop, or subject to strong physical shocks.
- Do not apply force to the card casing. Failure to observe this precaution could damage the card.
- Do not expose to water, heat, high levels of humidity, or direct sunlight.
- Do not format memory cards in a computer.

✘ No Memory Card

If no memory card is inserted, the control panel and viewfinder will show [-E-]. If the camera is turned off with a charged battery and no memory card inserted, [-E-] will be displayed in the control panel.

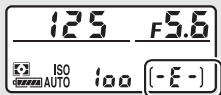

✘ The Write Protect Switch

SD memory cards are equipped with a write protect switch to prevent accidental loss of data. When this switch is in the “lock” position, the memory card can not be formatted and photos can not be deleted or recorded (a warning will be displayed in the monitor if you attempt to release the shutter). To unlock the memory card, slide the switch to the “write” position.

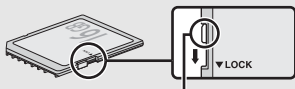

Write-protect switch

■ ■ Removing the Battery and Memory Cards

Removing the Battery

To remove the battery, turn the camera off and open the battery-chamber cover. Press the battery latch in the direction shown by the arrow to release the battery and then remove the battery by hand.

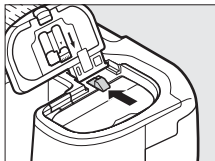

Removing Memory Cards

After confirming that the memory card access lamp is off, turn the camera off, open the memory card slot cover, and press the card in to eject it (①). The card can then be removed by hand (②).

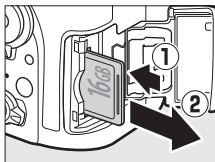

Attach a Lens

Be careful to prevent dust from entering the camera when the lens or body cap is removed. The lens generally used in this manual for illustrative purposes is an AF-S DX NIKKOR 18–140mm f/3.5–5.6G ED VR.

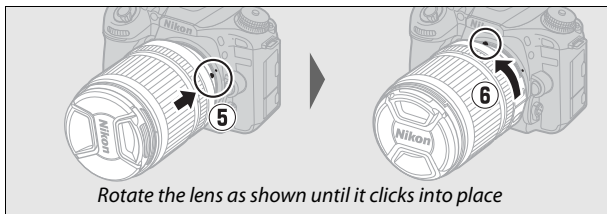
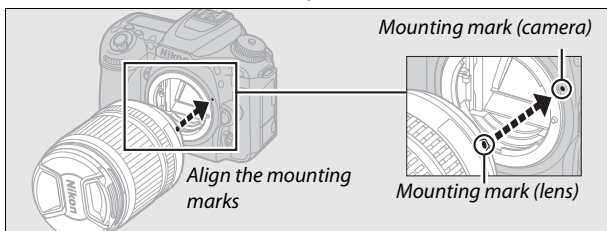
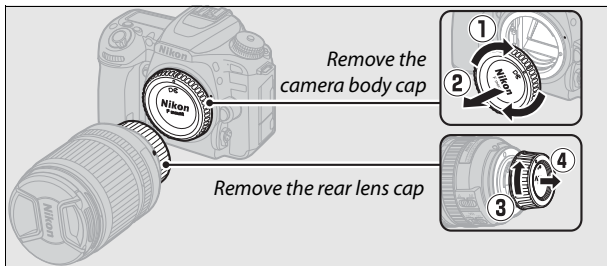

Be sure to remove the lens cap before taking pictures.

Detaching the Lens

Be sure the camera is off when removing or exchanging lenses. To remove the lens, press and hold the lens release button (①) while turning the lens clockwise (②). After removing the lens, replace the lens caps and camera body cap.

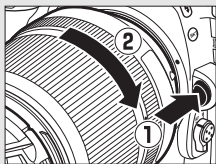

CPU Lenses with Aperture Rings

In the case of CPU lenses equipped with an aperture ring (☐ 280), lock aperture at the minimum setting (highest f-number).

Turn the Camera On

When you first turn the camera on, you will be prompted to choose a language using the multi selector and **OK** button.

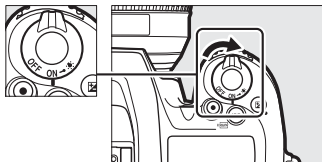

A connection wizard will be displayed; to pair the camera and smart device, proceed to “Connecting Using SnapBridge” (📖 28).



To proceed without using SnapBridge to pair the camera with the smart device, press **MENU** and use the multi selector and **OK** button to set the camera clock. No other operations can be performed until the clock is set.

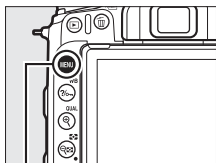

MENU button

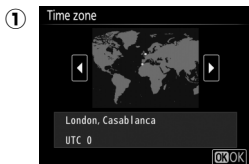

Select time zone

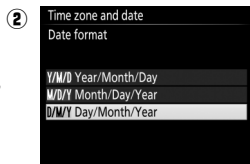

Select date format

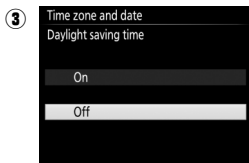

Select daylight saving time option

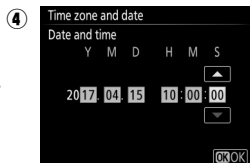

Set time and date (note that camera uses a 24-hour clock)

✓ Restarting Pairing at a Later Date

If you don't finish pairing the first time you turn the camera on, you can start pairing at any time by selecting **Connect to smart device** in the camera setup menu (☐ 272).

Connecting Using SnapBridge

Use SnapBridge to control the camera remotely from your smart device and download pictures from the camera. This section describes how to use the SnapBridge app for wireless connections between your camera and smart device. The instructions that follow refer to version 2.0 of the SnapBridge app; for information on the latest version, see the *SnapBridge Connection Guide* (pdf), available for download from the following website:

<http://downloadcenter.nikonimglib.com>

The Interface

The SnapBridge app features a menu (1) and three tabs (2–4).

- 1 Adjust settings or view app help or notifications from Nikon.
- 2 Adjust settings, principally for connection to the camera.
- 3 View pictures downloaded from the camera or delete or share images.
- 4 Access NIKON IMAGE SPACE via a dedicated app (app installation and Nikon ID required).

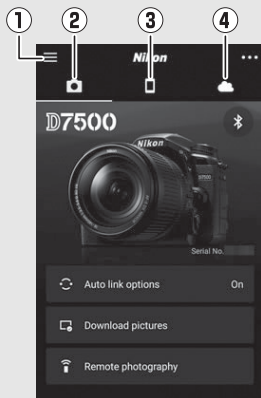

More on SnapBridge

For detailed information, consult online help (once pairing is complete, you can view online help by selecting **Help** in the SnapBridge app menu).

<https://nikonimglib.com/snbr/onlinehelp/en/index.html>

What SnapBridge Can Do for You

Use the SnapBridge app to:

- **Download pictures** as they are taken or select earlier photos for download
- **Take pictures remotely** using the controls in the SnapBridge app; the pictures are downloaded to the smart device as they are taken
- **Upload smart device location data** to the camera
- **Synchronize the camera clock** to the time reported by the smart device
- **Imprint pictures** with comments, the time of recording, and other information as they are taken

What You'll Need

Camera

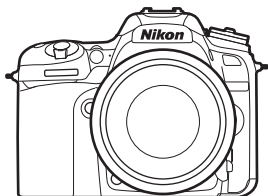

Memory card

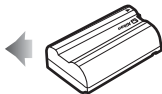

Battery

Smart device



Readying the Smart Device

Before connecting, ready your smart device by installing the SnapBridge app and enabling Bluetooth and Wi-Fi.

- 1** Search for “snapbridge” on the Apple App Store® (iOS) or Google Play™ (Android™) and install the SnapBridge app.



Information on supported operating systems is available from the download site. This camera is not compatible with the SnapBridge 360/170 app.

- 2** Enable Bluetooth and Wi-Fi on the smart device. Note that the actual connection to the camera will be made using the SnapBridge app; do not attempt to connect using the Settings app on your device.

Pairing and Connecting

Before pairing, confirm that there is space available on the camera memory card. To prevent unexpected interruptions, you should also check that the camera battery is fully charged.

An Android smart device is used for illustrative purposes in the instructions that follow.

- 1 Camera:** Press the MENU button and select the  icon to display the setup menu.

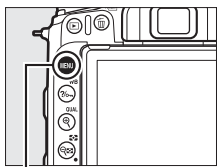

MENU button

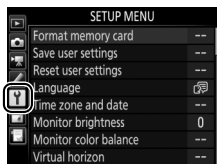

- 2 Camera:** Select **Connect to smart device** in the setup menu, then highlight **Start** and press .

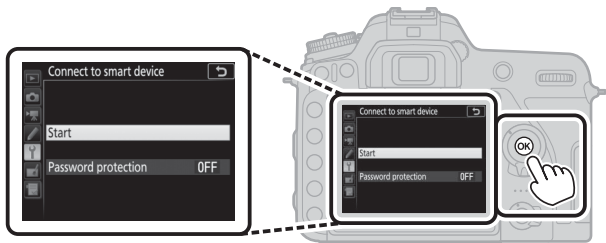

- 3 Camera:** Press **OK** when the following message is displayed.



- 4 Camera:** Confirm that the camera displays the message shown at right and ready the smart device.



- 5 Smart device:** Launch the SnapBridge app and tap **Pair with camera**.
If prompted to choose a camera, tap the camera name.



6 Smart device: Tap the camera name in the “Pair with camera” dialog.

Users who are pairing a camera with an iOS device for the first time will first be presented with pairing instructions; after reading the instructions, scroll to the bottom of the display and tap **Understood**. If you are then prompted to choose an accessory, tap the camera name again (there may be some delay before the camera name is displayed).

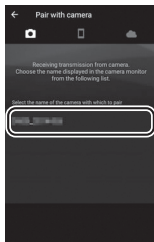

7 Camera/smart device: Confirm that the camera and smart device display the same six-digit number.

Some versions of iOS may not display a number; if no number displayed, proceed to Step 8.

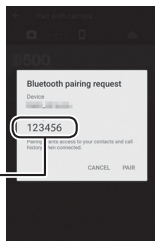
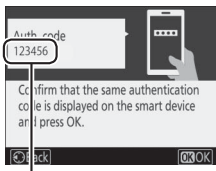

- 8 Camera/smart device:** Press **OK** on the camera and tap **PAIR** on the smart device (the display varies with the device and operating system).

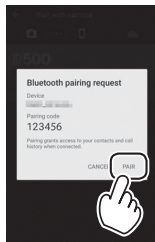

- 9 Camera/smart device:** Complete pairing.



- **Camera:** Press **OK** when the message at right is displayed.

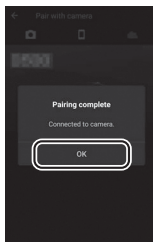

- **Smart device:** Tap **OK** when the message at right is displayed.



10 **Camera:** Follow the on-screen instructions to complete setup.

- **To allow the camera to add location data to photos,** select **Yes** in response to “Download location data from smart device?” and then enable location services on the smart device and enable **Auto link options > Synchronize location data** in the SnapBridge app  tab.
- **To synchronize the camera clock with the time provided by the smart device,** select **Yes** in response to “Sync clock with smart device?” and then enable **Auto link options > Synchronize clocks** in the SnapBridge app  tab.

The smart device and camera are now connected. Any pictures you take with the camera will automatically be uploaded to the smart device.

Connection Tips

Read this section for help connecting or downloading pictures from the camera.

The Wi-Fi Prompt (iOS Only)

SnapBridge usually relies on Bluetooth for connection between the camera and smart device, but will switch to Wi-Fi for remote photography and the like. In some versions of iOS, SnapBridge will prompt you to perform the switch manually, in which case you will need to follow the steps below.

- 1** After noting the camera network name (SSID) and password, tap **View options**. The default SSID is the same as the camera name.



- 2** In the network list, select the SSID you noted in Step 1.



- 3** When connecting via Wi-Fi for the first time, you will be prompted to enter the camera password. Enter the password you noted in Step 1 (note that passwords are case-sensitive). Once a connection is established, a ✓ will appear next to the camera SSID as shown at right; return to the SnapBridge app. You will not be required to enter a password when next you connect to the camera. The camera Wi-Fi SSID and password can be changed using the **Wi-Fi > Network settings** option in the camera setup menu. We recommend that you periodically change the password to protect your privacy.



More on Pairing and Connecting

This section describes some situations you may encounter while using the SnapBridge app.

“Unable to Connect.”

If the camera displays a message stating that it was unable to connect, press **OK** and return to Step 3 (📄 33) of “Pairing and Connecting”. To cancel pairing, press the **MENU** button.

Pairing Problems



If you experience problems connecting to the camera, try:

- **Exiting and relaunching the SnapBridge app.** Exit the SnapBridge app and confirm that it is not running in the background. Tap the app icon to re-launch the app and then repeat “Pairing and Connecting” from Step 1.
- **Requesting iOS to “forget” the camera (iOS only).** If pairing fails on an iOS device, the device may still remember the camera name, in which case you will need to request iOS to “forget” the camera as shown below.



Downloading Pictures

If you experience slow downloads or other problems downloading pictures to the smart device, end pairing and try pairing the devices again.

- 1 Smart device:** In the SnapBridge app, open the  tab, tap  > **Forget camera** > **D7500**, and tap **Yes** to end pairing when prompted. Users of iOS will then need to request iOS to “forget” the camera as shown below.

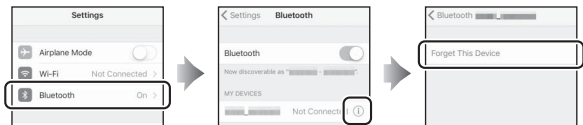
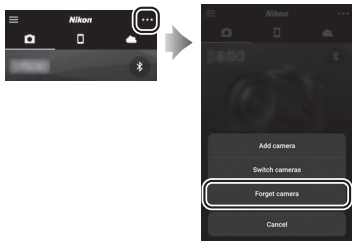

- 2 Camera:** Select **Connect to smart device** in the camera setup menu, highlight **Start**, press **OK**, and follow the instructions from Step 2 (📖 32) of “Pairing and Connecting” to pair the camera with the smart device.

Tutorial

Camera Menu: An Overview

Most shooting, playback, and setup options can be accessed from the camera menu. To view the menus, press the **MENU** button.

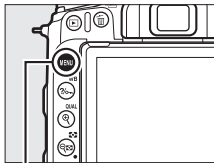

MENU button

Tabs

Choose from the following menus:

- : **Playback** (📖 250)
- : **Photo Shooting** (📖 252)
- : **Movie Shooting** (📖 257)
- : **Custom Settings** (📖 260)
- : **Setup** (📖 268)
- : **Retouch** (📖 275)
- : **MY MENU** or **RECENT SETTINGS**
(defaults to **MY MENU**; 📖 278)

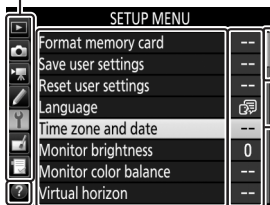

Slider shows position in current menu.

Current settings are shown by icons.

Menu options
Options in current menu.

Help icon (📖 42)

Using Camera Menus

■ Menu Controls

You can navigate the menus via the touch screen or using the multi selector and **OK** button.

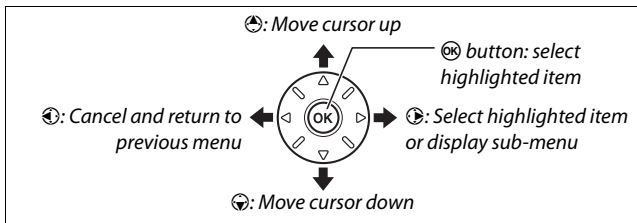

✎ The **?** (Help) Icon

If a **?** icon is displayed at the bottom left corner of the monitor, a description of the currently selected option or menu can be displayed by pressing the **?** (WB) button. Press **▲** or **▼** to scroll through the display. Press **?** (WB) again to return to the menus.

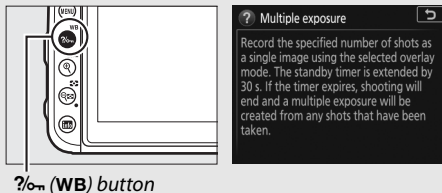

■ Navigating the Menus

Follow the steps below to navigate the menus.

1 Display the menus.

Press the **MENU** button to display the menus.

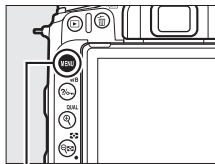

MENU button

2 Highlight the icon for the current menu.

Press  to highlight the icon for the current menu.

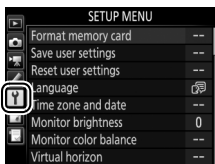

3 Select a menu.

Press  or  to select the desired menu.

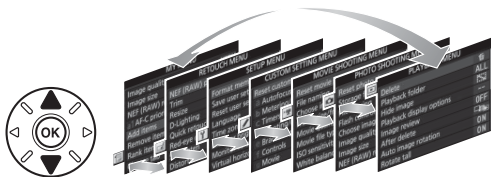

4 Position the cursor in the selected menu.

Press  to position the cursor in the selected menu.

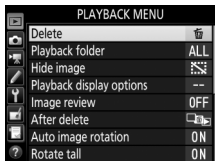

5 Highlight a menu item.

Press or to highlight a menu item.

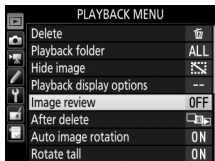

6 Display options.

Press to display options for the selected menu item.



7 Highlight an option.

Press or to highlight an option.

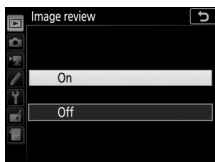

8 Select the highlighted item.

Press to select the highlighted item. To exit without making a selection, press the MENU button.



Note the following:

- Menu items that are displayed in gray are not currently available.
- While pressing generally has the same effect as pressing , there are some cases in which selection can only be made by pressing .
- To exit the menus and return to shooting mode, press the shutter-release button halfway.

■ ■ Using the Touch Screen

You can also navigate the menus using the following touch screen operations.

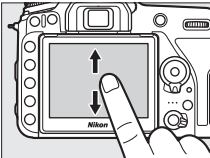
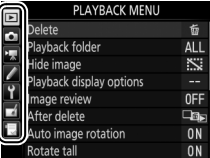
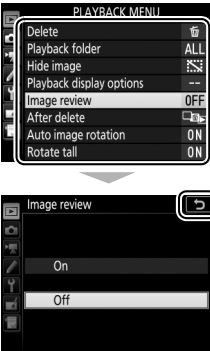
Scroll	Slide up or down to scroll.																			
Choose a menu	Tap a menu icon to choose a menu.	 <table border="1"><thead><tr><th colspan="2">PLAYBACK MENU</th></tr></thead><tbody><tr><td>Delete</td><td></td></tr><tr><td>Playback folder</td><td>ALL</td></tr><tr><td>Hide image</td><td></td></tr><tr><td>Playback display options</td><td>--</td></tr><tr><td>Image review</td><td>OFF</td></tr><tr><td>After delete</td><td></td></tr><tr><td>Auto image rotation</td><td>ON</td></tr><tr><td>Rotate tall</td><td>ON</td></tr></tbody></table>	PLAYBACK MENU		Delete		Playback folder	ALL	Hide image		Playback display options	--	Image review	OFF	After delete		Auto image rotation	ON	Rotate tall	ON
PLAYBACK MENU																				
Delete																				
Playback folder	ALL																			
Hide image																				
Playback display options	--																			
Image review	OFF																			
After delete																				
Auto image rotation	ON																			
Rotate tall	ON																			
Select options/adjust settings	Tap menu items to display options and tap icons or sliders to change. To exit without changing settings, tap ↶.	 <table border="1"><thead><tr><th colspan="2">Image review</th></tr></thead><tbody><tr><td>On</td><td></td></tr><tr><td>Off</td><td></td></tr></tbody></table>	Image review		On		Off													
Image review																				
On																				
Off																				

The Battery Level and Number of Exposures Remaining

■ Battery Level

The battery level is shown in the control panel and viewfinder.



Control panel

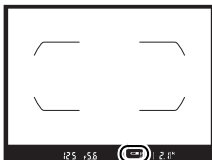

Viewfinder

Control panel	Viewfinder	Description
	—	Battery fully charged.
	—	Battery partially discharged.
	—	
	—	
		Low battery. Charge battery or ready spare battery.
 (flashes)	 (flashes)	Shutter release disabled. Charge or exchange battery.

■ ■ Number of Exposures Remaining

The control panel and viewfinder show the number of photographs that can be taken at current settings (values over 1000 are rounded down to the nearest hundred; e.g., values between 2100 and 2199 are shown as 2.1 k).

Number of exposures
remaining







Control panel



Viewfinder

Basic Photography and Playback

“Point-and-Shoot” Photography (AUTO and Modes)

This section describes how to take photographs in  and  modes.  and  are automatic “point-and-shoot” modes in which the majority of settings are controlled by the camera in response to shooting conditions; the only difference between the two is that the flash will not fire in  mode.



1 Turn the camera on.

The information display and control panel will light.

Power switch

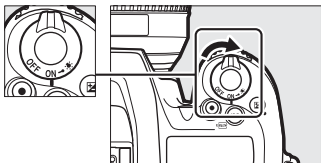

- 2** Pressing the mode dial lock release on top of the camera, rotate the mode dial to **AUTO** or **📷**.

Mode dial

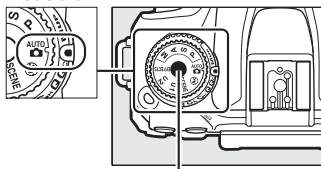

Mode dial lock release

Photographs can be framed in the viewfinder or in the monitor (live view). To start live view, rotate the live view selector to **📷** and press the **Lv** button.

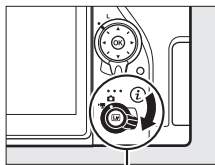

Live view selector

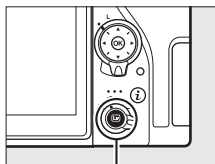

Lv button



Framing pictures in the viewfinder



Framing pictures in the monitor (live view)

3 Ready the camera.

Viewfinder photography: When framing photographs in the viewfinder, hold the handgrip in your right hand and cradle the camera body or lens with your left. Bring your elbows in against the sides of your chest.



Live view: When framing photographs in the monitor, hold the handgrip in your right hand and cradle the lens with your left.



▣ Framing Photographs in Portrait (Tall) Orientation

When framing photographs in portrait (tall) orientation, hold the camera as shown below.



*Framing photographs
in the viewfinder*



*Framing photographs
in the monitor*

4 Frame the photograph.

Viewfinder photography: Frame a photograph in the viewfinder with the main subject in the AF area brackets.

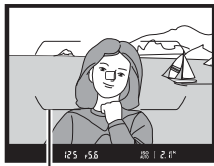

AF area brackets

Live view: At default settings, the camera automatically detects faces and selects the focus point. If no face is detected, use the multi selector to position the focus point over the main subject.

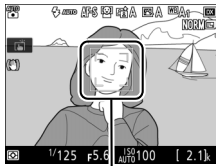

Focus point

Using a Zoom Lens

Use the zoom ring to zoom in on the subject so that it fills a larger area of the frame, or zoom out to increase the area visible in the final photograph (select longer focal lengths on the lens focal length scale to zoom in, shorter focal lengths to zoom out).

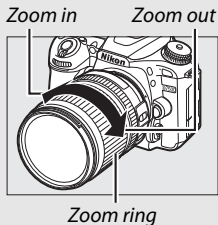

5 Press the shutter-release button halfway.



Viewfinder photography: Press the shutter-release button halfway to focus (the AF-assist illuminator may light if the subject is poorly lit). When the focus operation is complete, the active focus point and in-focus indicator (●) will appear in the viewfinder.

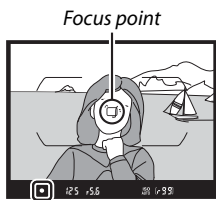

Focus indicator

In-focus indicator	Description
●	Subject in focus.
▶	Focus point is between camera and subject.
◀	Focus point is behind subject.
▶◀ (flashes)	Camera unable to focus using autofocus (114).

Live view: The focus point flashes green while the camera focuses. If the camera is able to focus, the focus point will be displayed in green; otherwise, the focus point will flash red.



Focus point

6 Shoot.

Smoothly press the shutter-release button the rest of the way down to take the photograph. The memory card access lamp will light and the photograph will be displayed in the monitor for a few seconds. *Do not eject the memory card or remove or disconnect the power source until the lamp has gone out and recording is complete.*

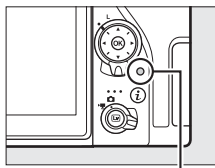

Memory card access lamp

To end live view, press the **[Lv]** button.

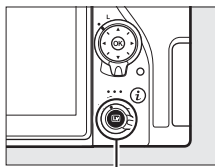

[Lv] button

The Standby Timer (Viewfinder Photography)

The viewfinder and some control panel displays will turn off if no operations are performed for about six seconds, reducing the drain on the battery. Press the shutter-release button halfway to reactivate the display. The length of time before the standby timer expires automatically can be selected using Custom Setting c2 (**Standby timer**,  263).

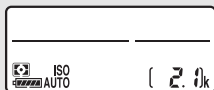
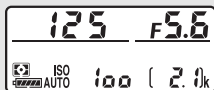

125 F5.6

ISO
AUTO (2.0)^k

Exposure meters on

Exposure meters off

The Built-in Flash

If additional lighting is required for correct exposure in **AUTO** mode, the built-in flash will pop up automatically when the shutter-release button is pressed halfway. If the flash is raised, photographs can only be taken when the flash-ready indicator (⚡) is displayed. If the flash-ready indicator is not displayed, the flash is charging; remove your finger briefly from the shutter-release button and try again.

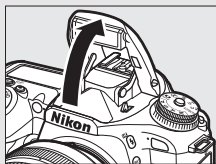

Viewfinder



Live view

To save power when the flash is not in use, press it gently downward until the latch clicks into place.

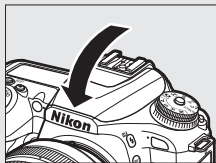

Tips for Live View

■ Viewing and Hiding Indicators

Pressing the **Info** button cycles through the following displays.

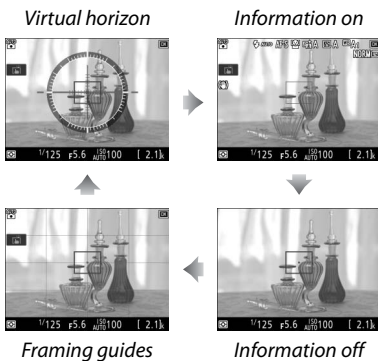

■ Live View Zoom Preview

Press the **QUAL** button to magnify the view in the monitor up to a maximum of about 17×. A navigation window will appear in a gray frame at the bottom right corner of the display. Use the multi selector to scroll to areas of the frame not visible in the monitor, or press **QUAL** (**↔**) to zoom out.

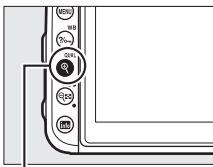

QUAL button



Navigation window

☑ The Count Down Display

A count down will be displayed 30 s before live view ends automatically (the timer turns red if live view is about to end to protect the internal circuits or, if an option other than **No limit** is selected for Custom Setting c4—**Monitor off delay** > **Live view**; ☐ 263—5 s before the monitor is due to turn off automatically). Depending on shooting conditions, the timer may appear immediately when live view is selected.

☑ The Monitor off Delay (Live View)

The monitor will turn off if no operations are performed for about ten minutes. The length of time before the monitor turns off automatically can be selected using Custom Setting c4 (**Monitor off delay**, ☐ 263) > **Live view**.

☑ Exposure

Depending on the scene, exposure may differ from that which would be obtained when live view is not used.

✔ Shooting in Live View

To prevent light entering via the viewfinder from interfering with photographs and exposure, the rubber eyecup can be removed and the viewfinder covered with the supplied eyepiece cap before shooting (☞ 90).

Although they will not appear in the final picture, jagged edges, color fringing, moiré, and bright spots may appear in the monitor, while bright regions or bands may appear in some areas with flashing signs and other intermittent light sources or if the subject is briefly illuminated by a strobe or other bright, momentary light source. In addition, distortion may occur with moving subjects, particularly if the camera is panned horizontally or an object moves horizontally at high speed through the frame. Flicker and banding visible in the monitor under fluorescent, mercury vapor, or sodium lamps can be reduced using **Flicker reduction** option in the movie shooting menu (☞ 259), although they may still be visible in the final photograph at some shutter speeds. When shooting in live view, avoid pointing the camera at the sun or other strong light sources. Failure to observe this precaution could result in damage to the camera's internal circuitry.

Using live view for extended periods may cause the grip and areas of the camera around the monitor to become hot. This does not indicate a malfunction.

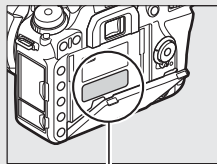

This area becomes particularly hot.

Basic Playback



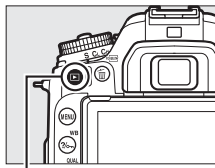

1 Press the button.

A photograph will be displayed in the monitor.



 button

2 View additional pictures.

Additional pictures can be displayed by pressing  or  or flicking a finger left or right over the display. To view additional information on the current photograph, press  and  (📖 231).

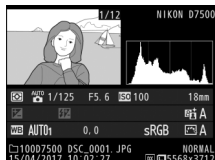

To end playback and return to shooting mode, press the shutter-release button halfway.

Image Review

When **On** is selected for **Image review** in the playback menu (📖 250), photographs are automatically displayed in the monitor after shooting.

Deleting Unwanted Photographs

To delete the photograph currently displayed in the monitor, press the  (FORMAT) button. *Note that photographs can not be recovered once deleted.*

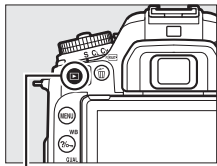

1 Display the photograph.

Display the photograph you wish to delete as described in “Basic Playback” (📖 59).



 button

2 Delete the photograph.

Press the  (FORMAT) button. A confirmation dialog will be displayed; press the  (FORMAT) button again to delete the image and return to playback. To exit without deleting the picture, press .

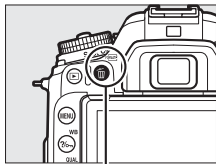

 (FORMAT) button



Delete

To delete selected images (📖 248), all images taken on a selected date (📖 249), or all images in a chosen location on the memory card (📖 248), use the **Delete** option in the playback menu.

Matching Settings to the Subject or Situation (Scene Mode)

The camera offers a choice of “scene” modes. Choosing a scene mode automatically optimizes settings to suit the selected scene, making creative photography as simple as selecting a mode, framing a picture, and shooting as described in “Point-and-Shoot’ Photography (AUTO and Modes)” (48).

Choosing a Scene Mode

The following scenes can be selected by rotating the mode dial to **SCENE** and rotating the main command dial until the desired scene appears in the monitor.

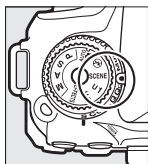

Mode dial

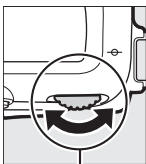



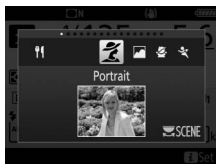





Main command dial













Monitor

Note that the scene can not be changed during movie recording.

■ ■ Scenes

Option	Description
 Portrait	Use for portraits with soft, natural-looking skin tones. If the subject is far from the background or a telephoto lens is used, background details will be softened to lend the composition a sense of depth.
 Landscape	Use for vivid landscape shots in daylight. ^{1,2}
 Child	Use for snapshots of children. Clothing and background details are vividly rendered, while skin tones remain soft and natural.
 Sports	Fast shutter speeds freeze motion for dynamic sports shots in which the main subject stands out clearly. ^{1,2}
 Close Up	Use for close-up shots of flowers, insects, and other small objects (a macro lens can be used to focus at very close ranges).
 Night Portrait	Use for a natural balance between the main subject and the background in portraits taken under low light.
 Night Landscape	Reduce noise and unnatural colors when photographing night landscapes, including street lighting and neon signs. ^{1,2}
 Party/Indoor	Capture the effects of indoor background lighting. Use for parties and other indoor scenes.
 Beach/Snow	Capture the brightness of sunlight expanses of water, snow, or sand. ^{1,2}

Option	Description
 Sunset	Preserves the deep hues seen in sunsets and sunrises. ^{1,2}
 Dusk/Dawn	Preserves the colors seen in the weak natural light before dawn or after sunset. ^{1,2}
 Pet Portrait	Use for portraits of active pets. ²
 Candlelight	For photographs taken by candlelight. ¹
 Blossom	Use for fields of flowers, orchards in bloom, and other landscapes featuring expanses of blossoms. ¹
 Autumn Colors	Captures the brilliant reds and yellows in autumn leaves. ¹
 Food	Use for vivid photographs of food. For flash photography, press the  () button to raise the flash ( 161).

1 The built-in flash turns off.

2 The AF-assist illuminator turns off.

Preventing Blur

Use a tripod to prevent blur caused by camera shake at slow shutter speeds.

Special Effects

Special effects can be used when taking photographs and shooting movies.

Choosing Special Effects

The following effects can be selected by rotating the mode dial to **EFFECTS** and rotating the main command dial until the desired option appears in the monitor.

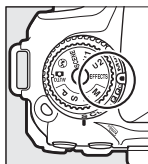

Mode dial

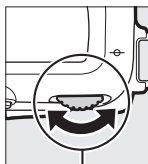



Main command dial







Monitor

Note that the effect can not be changed during movie recording.

Special Effects

Option	Description
 Night Vision	Use under conditions of darkness to record monochrome images at high ISO sensitivities (manual focus is available if the camera is unable to focus). ¹
VI Super Vivid	Overall saturation and contrast are increased for a more vibrant image.
POP Pop	Overall saturation is increased for a more lively image.
 Photo Illustration	Sharpen outlines and simplify coloring for a poster effect that can be adjusted in live view (□ 66). Movies shot in this mode play back like a slide show made up of a series of stills.
 Toy Camera Effect	Create photos and movies that appear to have been shot with a toy camera. The effect can be adjusted in live view (□ 67).

Option	Description
 Miniature Effect	Create photos that appear to be pictures of dioramas. Works best when shooting from a high vantage point. Miniature effect movies play back at high speed, compressing about 45 minutes of footage shot at 1920 × 1080/30p into a silent movie that plays back in about three minutes. The effect can be adjusted in live view (☐ 68). ^{1,2}
 Selective Color	All colors other than the selected colors are recorded in black and white. The effect can be adjusted in live view (☐ 70). ¹
 Silhouette	Silhouette subjects against bright backgrounds. ¹
 High Key	Use when shooting bright scenes to create bright images that seem filled with light. ¹
 Low Key	Use when shooting dark scenes to create dark, low-key images with prominent highlights. ¹





1 The built-in flash turns off.

2 The AF-assist illuminator turns off.

Preventing Blur

Use a tripod to prevent blur caused by camera shake at slow shutter speeds.

NEF (RAW)

NEF (RAW) recording is not available in , VI, POP, , , , and  modes. Pictures taken when an NEF (RAW) or NEF (RAW) + JPEG option is selected in these modes will be recorded as JPEG images. JPEG images created at settings of NEF (RAW) + JPEG will be recorded at the selected JPEG quality, while images recorded at a setting of NEF (RAW) will be recorded as fine-quality images.

and Modes

Autofocus is not available during movie recording. The live view refresh rate will drop, together with the frame rate for continuous release mode; using autofocus during live view will disrupt the preview.

Options Available in Live View

Settings for the selected effect are adjusted in the live view display.

■ ■ *Photo Illustration*

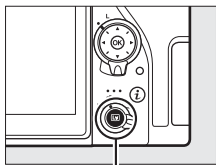

1 Select live view.

Press the  button. The view through the lens will be displayed in the monitor.



 button

2 Adjust outline thickness.

Press  to display options. Press  or  to make outlines thicker or thinner.



3 Press .

Press  to exit when settings are complete.

1 Select live view.

Press the **Lv** button. The view through the lens will be displayed in the monitor.

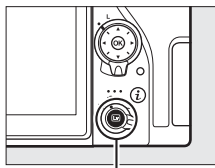

Lv button

2 Adjust options.

Press **OK** to display options. Press **Up** or **Down** to highlight **Vividness** or **Vignetting** and press **Left** or **Right** to change. Adjust vividness to make colors more or less saturated, vignetting to control the amount of vignetting.



3 Press **OK**.

Press **OK** to exit when settings are complete.

1 Select live view.

Press the **Lv** button. The view through the lens will be displayed in the monitor.

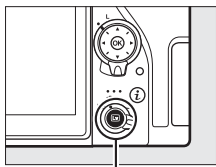

Lv button

2 Position the focus point.



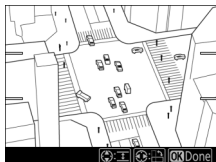

Use the multi selector to position the focus point in the area that will be in focus and then press the shutter-release button halfway to check focus. To temporarily clear miniature effect options from the display and enlarge the view in the monitor for precise focus, press **QUAL**. Press **Q** (**Q**) to restore the miniature effect display.

**3 Display options.**

Press **OK** to display miniature effect options.



4 Adjust options.

Press  or  to choose the orientation of the area that will be in focus and press  or  to adjust its width.

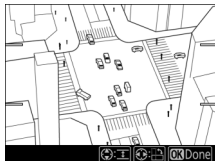

5 Press .

Press  to exit when settings are complete.

1 Select live view.

Press the **Lv** button. The view through the lens will be displayed in the monitor.

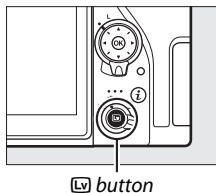

2 Display options.

Press **OK** to display selective color options.





3 Select a color.

Frame an object in the white square in the center of the display and press **UP** to choose the color of the object as one that will remain in the final image (the camera may have difficulty detecting unsaturated colors; choose a saturated color). To zoom in on the center of the display for more precise color selection, press **+** (**QUAL**). Press **+** (**QUAL**) to zoom out.

Selected color



4 Choose the color range.

Press  or  to increase or decrease the range of similar hues that will be included in the final image. Choose from values between 1 and 7; note that higher values may include hues from other colors.

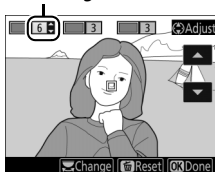

Color range



5 Select additional colors.

To select additional colors, rotate the main command dial to highlight another of the three color boxes at the top of the display and repeat Steps 3 and 4 to



select another color. Repeat for a third color if desired. To deselect the highlighted color, press  (FORMAT). To remove all colors, press and hold  (FORMAT). A confirmation dialog will be displayed; select **Yes**.



6 Press .

Press  to exit when settings are complete. During shooting, only objects of the selected hues will be recorded in color; all others will be recorded in black-and-white.

P, S, A, and M Modes

P, S, A, and M modes offer different degrees of control over shutter speed and aperture.



Choosing a Mode

Mode	Description
P	Programmed auto (☐ 73): Camera sets shutter speed and aperture for optimal exposure. Recommended for snapshots and in other situations in which there is little time to adjust camera settings.
S	Shutter-priority auto (☐ 74): User chooses shutter speed; camera selects aperture for best results. Use to freeze or blur motion.
A	Aperture-priority auto (☐ 75): User chooses aperture; camera selects shutter speed for best results. Use to blur background or bring both foreground and background into focus.
M	Manual (☐ 76): User controls both shutter speed and aperture. Set shutter speed to Bulb (b u l b) or Time (- -) for long time-exposures.

Lens Types

When using a CPU lens equipped with an aperture ring (☐ 280), lock the aperture ring at the minimum aperture (highest f-number). Type G and E lenses are not equipped with an aperture ring.

Non-CPU lenses can only be used in mode M (manual), when aperture can only be adjusted using the lens aperture ring. Selecting any other mode disables the shutter release. For more information, see “Compatible Lenses” (☐ 279).

S: Shutter-Priority Auto

In shutter-priority auto, you choose the shutter speed while the camera automatically selects the aperture that will produce the optimal exposure.

To choose a shutter speed, rotate the main command dial while the exposure meters are on. Shutter speed can be set to “x 250” or to values between 30 s and $\frac{1}{8000}$ S.

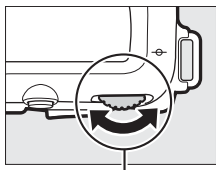

Main command dial

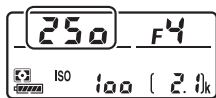

Control panel



Monitor

See Also

For information on what to do if a flashing “b u l b” (“Bulb”) or “- -” (“Time”) indicator appears in the shutter-speed displays, see “Error Messages” (□ 309).

A: Aperture-Priority Auto

In aperture-priority auto, you choose the aperture while the camera automatically selects the shutter speed that will produce the optimal exposure.

To choose an aperture between the minimum and maximum values for the lens, rotate the sub-command dial while the exposure meters are on.

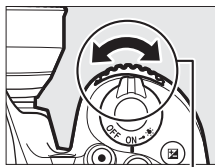

Sub-command dial

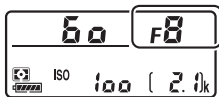

Control panel



Monitor

Beeps During Live View

A beep may sound if you adjust aperture, use the live view selector, or rotate the mode dial during live view. This does not indicate an error or malfunction.

M: Manual

In manual exposure mode, you control both shutter speed and aperture. While the exposure meters are on, rotate the main command dial to choose a shutter speed, and the sub-command dial to set aperture. Shutter speed can be set to “x 250” or to values between 30 s and $\frac{1}{8000}$ s, or the shutter can be held open indefinitely for a long time-exposure (b u l b or - -, 79). Aperture can be set to values between the minimum and maximum values for the lens. Use the exposure indicators to check exposure.

Aperture:

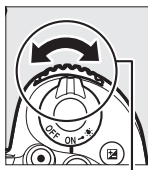

Sub-command dial

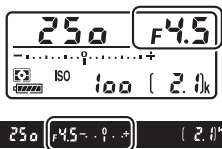

Shutter speed:



Main command dial

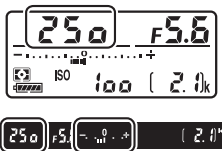







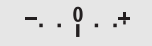

AF Micro NIKKOR Lenses

Provided that an external exposure meter is used, the exposure ratio need only be taken into account when the lens aperture ring is used to set aperture.

The Exposure Indicators

If a shutter speed other than “bulb” or “time” is selected, the exposure indicators show whether the photograph would be under- or over-exposed at current settings. Depending on the option chosen for Custom Setting b2 (**EV steps for exposure cntrl**,  262), the amount of under- or over-exposure is shown in increments of $\frac{1}{3}$ EV or $\frac{1}{2}$ EV. If the limits of the exposure metering system are exceeded, the displays will flash.

Custom Setting b2 set to $\frac{1}{3}$ step			
	Optimal exposure	Underexposed by $\frac{1}{3}$ EV	Overexposed by 2 EV
Control panel			
Viewfinder (viewfinder photography)			
Monitor (live view)			

Beeps During Live View

A beep may sound if you adjust aperture, use the live view selector, or rotate the mode dial during live view. This does not indicate an error or malfunction.

Exposure Preview

In modes **P**, **S**, **A**, and **M**, you can use live view to preview how changes to shutter speed, aperture, and ISO sensitivity will affect exposure: simply press the **i** button and select **On** for **Exposure preview** (note that although exposure compensation can be set to values between -5 and $+5$ EV, only values

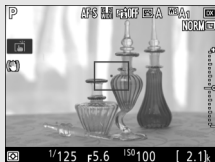

between -3 and $+3$ can be previewed in the monitor). Exposure preview is unavailable at shutter speeds of **b**, **u**, **z**, **b** (bulb) and **-** (time), while the preview may not accurately reflect the final result during bracketing, at a shutter speed of **x**, **z**, **S**, **a**, when exposure preview is used with Active D-Lighting (☐ 153) or HDR (high dynamic range; ☐ 155), when **A** (auto) is selected for the Picture Control Contrast parameter (☐ 151), or when the built-in flash is used or an optional flash unit is attached. If the subject is very bright or very dark, exposure may not be accurately reflected in the display and the exposure indicator will flash.

See Also

For information on reversing the exposure indicators so that negative values are displayed on the right and positive values on the left, see  > Custom Setting f5 (**Reverse indicators**, ☐ 267).

Long Time-Exposures (M Mode Only)

Select the following shutter speeds for long time-exposures of moving lights, the stars, night scenery, or fireworks.

- **Bulb (b u l b):** The shutter remains open while the shutter-release button is held down. To prevent blur, use a tripod or an optional wireless remote controller (☞ 287) or remote cord (☞ 287).
- **Time (- -):** Start the exposure using the shutter-release button on the camera or on an optional remote control, remote cord, or wireless remote controller. The shutter remains open until the button is pressed a second time.



*Shutter speed: b u l b
(35-second exposure)
Aperture: f/25*

Before proceeding, mount the camera on a tripod or place it on a stable, level surface. To prevent light entering via the viewfinder from appearing in the photograph or interfering with exposure, remove the rubber eyecup and cover the viewfinder with the supplied eyepiece cap (☞ 90). Nikon recommends using a fully charged battery or an optional AC adapter and power connector to prevent loss of power while the shutter is open. Note that noise (bright spots, randomly-spaced bright pixels, or fog) may be present in long exposures. Bright spots and fog can be reduced by choosing **On** for **Long exposure NR** in the photo shooting menu (☞ 255).

ML-L3 Remote Controls

If you will be using an ML-L3 remote control, select a remote control mode (**Delayed remote**, **Quick-response remote**, or **Remote mirror-up**) using the **Remote control mode (ML-L3)** option in the photo shooting menu (☰ 175). Note that if you are using an ML-L3 remote control, pictures will be taken in “Time” mode even when “Bulb”/b  is selected for shutter speed. The exposure starts when the shutter-release button on the remote control is pressed and ends after 30 minutes or when the button is pressed again.

User Settings: U1 and U2 Modes

Assign frequently-used settings to the **U1** and **U2** positions on the mode dial.

Saving User Settings

1 Select a mode.

Rotate the mode dial to the desired mode.

Mode dial

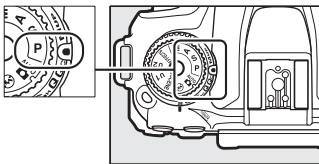

2 Adjust settings.

Make the desired adjustments to flexible program (mode **P**), shutter speed (modes **S** and **M**), aperture (modes **A** and **M**), exposure and flash compensation, flash mode, focus point, metering, autofocus and AF-area modes, bracketing, and settings in the photo shooting, movie shooting, and Custom Settings menus.

User Settings

The following can not be saved to **U1** or **U2**.

Photo shooting menu:

- Storage folder
- Choose image area
- Manage Picture Control
- Remote control mode (ML-L3)
- Multiple exposure
- Interval timer shooting

Movie shooting menu:

- Choose image area
- Manage Picture Control
- Time-lapse movie

Custom Settings menu:

- a10 (Manual focus ring in AF mode)
- d9 (Optical VR)

3 Select **Save user settings**.

Press the **MENU** button to display the menus. Highlight **Save user settings** in the setup menu and press .

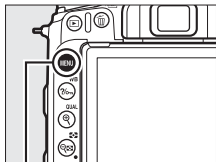

MENU button



4 Select **Save to U1** or **Save to U2**.

Highlight **Save to U1** or **Save to U2** and press .

5 Save user settings.

Highlight **Save settings** and press  to assign the settings selected in Steps 1 and 2 to the mode dial position selected in Step 4.

Recalling User Settings

Simply rotate the mode dial to **U1** to recall the settings assigned to **Save to U1**, or to **U2** to recall the settings assigned to **Save to U2**.

Mode dial

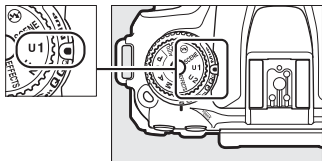

Resetting User Settings

To reset settings for **U1** or **U2** to default values:

1 Select **Reset user settings**.

Press the **MENU** button to display the menus. Highlight **Reset user settings** in the setup menu and press .

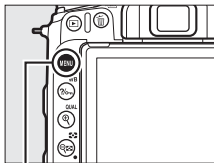

MENU button

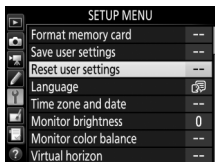

2 Select **Reset U1** or **Reset U2**.

Highlight **Reset U1** or **Reset U2** and press .

3 Reset user settings.

Highlight **Reset** and press .

Release Mode

Choosing a Release Mode

To choose a release mode, press the release mode dial lock release and turn the release mode dial so that the pointer aligns with the desired setting.

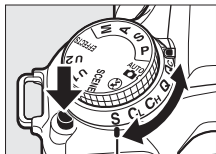

Pointer



Mode	Description
S	Single frame: Camera takes one photograph each time shutter-release button is pressed.
CL	Continuous low speed: While shutter-release button is held down, camera records 1–7 frames per second. * Frame rate can be chosen using Custom Setting d1 (CL mode shooting speed , □ 263).
CH	Continuous high speed: While shutter-release button is held down, camera records up to 8 frames per second. * Use for active subjects.
Q	Quiet shutter-release: As for single frame, except that mirror does not click back into place while shutter-release button is fully pressed, allowing user to control timing of click made by mirror, which is also quieter than in single frame mode. In addition, beep does not sound regardless of setting selected for Beep options in the setup menu (□ 271).
Qc	Qc (quiet continuous) shutter-release: While shutter-release button is held down, camera records up to 3 frames per second. * Camera noise is reduced.
⌚	Self-timer: Take pictures with the self-timer (□ 89).
MUP	Mirror up: Choose this mode to minimize camera shake in telephoto or close-up photography or in other situations in which the slightest camera movement can result in blurred photographs (□ 91).

Live View

If a continuous release mode is used during live view, photographs will be displayed in place of the view through the lens while the shutter-release button is pressed.

See Also

For information on:



- Choosing the maximum number of photographs that can be taken in a single burst, see  > Custom Setting d2 (**Max. continuous release**,  263).
- The number of pictures that can be taken in a single burst, see “Memory Card Capacity” ( 347).

Cover the Viewfinder

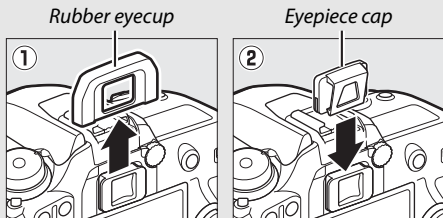
When taking photos without your eye to the viewfinder, remove the rubber eyecup (1) and insert the supplied eyepiece cap as shown (2). This prevents light entering via the viewfinder from appearing in photographs or interfering with exposure. Hold the camera firmly when removing the rubber eyecup.





Using the Built-in Flash

Before taking a photograph with the flash in modes that require the flash to be raised manually, press the  button to raise the flash and wait for the flash-ready indicator () to be displayed (□ 161). Shooting will be interrupted if the flash is raised after the self-timer has started. Note that only one photograph will be taken when the flash fires, regardless of the number of exposures selected for Custom Setting c3 (**Self-timer**; □ 263).

See Also

For information on:

- Choosing the duration of the self-timer, the number of shots taken, and the interval between shots, see  > Custom Setting c3 (**Self-timer**; □ 263).
- The beeps that sound when the self-timer is used, see  > **Beep options** (□ 271).

Mirror up Mode (MUP)

Choose this mode to minimize blurring caused by camera movement when the mirror is raised. To use mirror-up mode, press the release mode dial lock release and rotate the release mode dial to **MUP** (mirror up).

Release mode dial lock release

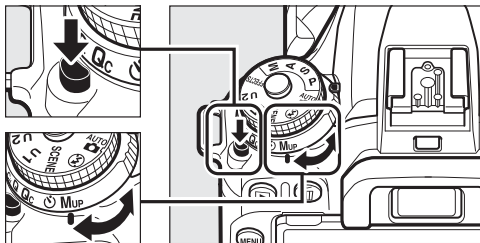

Release mode dial

After pressing the shutter-release button halfway to set focus and exposure, press the shutter-release button the rest of the way down to raise the mirror. **rdy** will be displayed in the control panel; press the shutter-release button all the way down again to take the picture (in live view, there is no need to raise the mirror; the picture is taken the first time the shutter-release button is pressed all the way down). A beep will sound, unless **Off** is selected for **Beep options > Beep on/off** in the setup menu (📖 271). The mirror lowers when shooting ends.

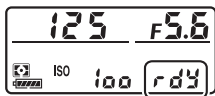

Mirror Up

While the mirror is raised, photos can not be framed in the viewfinder and autofocus and metering will not be performed.

Mirror up Mode

A picture will be taken automatically if no operations are performed for about 30 s with the mirror raised.

Preventing Blur

To prevent blurring caused by camera movement, press the shutter-release button smoothly, or use an optional remote control, wireless remote controller, or remote cord (📖 287). For information on using the optional ML-L3 remote control for mirror-up photography, see “Remote Control Photography” (📖 175). Use of a tripod is recommended.

See Also



For information on using the electronic front-curtain shutter to further reduce blur, see  > Custom Setting d4 (**Electronic front-curtain shutter**, 📖 264).

Image Recording Options

Image Area

Choose an image area from **DX (24×16)** and **1.3× (18×12)**.

Option	Description
 DX (24×16)	Pictures are recorded using a 23.5 × 15.7 mm image area (DX format).
 1.3× (18×12)	Pictures are recorded using a 18.0 × 12.0 mm image area, producing a telephoto effect without the need to change lenses.

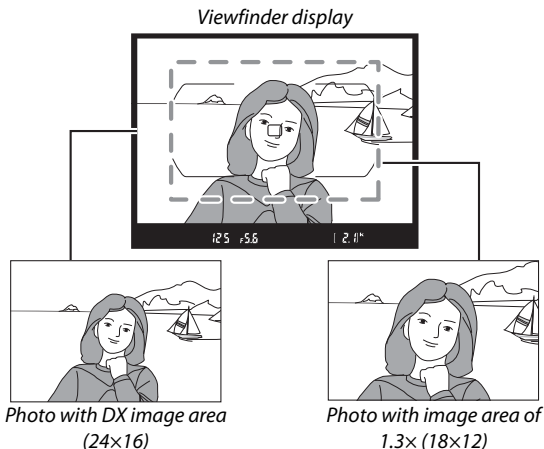

Image Area

The selected option is shown in the display.



Information display



Shooting display

The Viewfinder Display

A  icon is displayed in the viewfinder when the 1.3× DX crop is selected.



1.3× DX crop

See Also

For information on:



- The crops available for movie recording, see “The Movie Crop” (□ 190).
- The number of pictures that can be stored at different image area settings, see “Memory Card Capacity” (□ 347).

The image area can be selected using the **Choose image area** option in the photo shooting menu or by pressing a control and rotating a command dial.

■ ■ *The Choose Image Area Menu*

- 1 Select Choose image area.**
Highlight **Choose image area** in the photo shooting menu and press .



- 2 Adjust settings.**
Choose an option and press . The selected crop is displayed in the viewfinder ( 94).

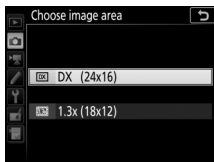



Image Size

Image size varies with the option selected for image area ( 99).

1 Assign image area selection to a camera control.

Use Custom Setting f1 (**Custom control assignment**,  266) to assign **Choose image area** to a control.

2 Use the selected control to choose an image area.

The image area can be selected by pressing the selected control and rotating the main or sub-command dial until the desired crop is displayed in the viewfinder ( 94).

The option currently selected for image area can be viewed by pressing the control to display the image area in the control panel or information display. DX format is displayed as "24 - 16" and 1.3× as "18 - 12".

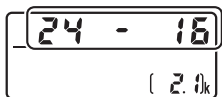

Image Quality

The D7500 supports the following image quality options:

Option	File type	Description
NEF (RAW)	NEF	RAW data from the image sensor are saved without additional processing. Settings such as white balance and contrast can be adjusted after shooting.
NEF (RAW)+ JPEG fine★/ NEF (RAW)+ JPEG fine	NEF/ JPEG	Two images are recorded, one NEF (RAW) image and one fine-quality JPEG image.
NEF (RAW)+ JPEG normal★/ NEF (RAW)+ JPEG normal		Two images are recorded, one NEF (RAW) image and one normal-quality JPEG image.
NEF (RAW)+ JPEG basic★/ NEF (RAW)+ JPEG basic		Two images are recorded, one NEF (RAW) image and one basic-quality JPEG image.
JPEG fine★/ JPEG fine	JPEG	Record JPEG images at a compression ratio of roughly 1:4 (fine quality).
JPEG normal★/ JPEG normal		Record JPEG images at a compression ratio of roughly 1:8 (normal quality).
JPEG basic★/ JPEG basic		Record JPEG images at a compression ratio of roughly 1:16 (basic quality).

See Also

For information on the number of pictures that can be stored at different image quality and size settings, see “Memory Card Capacity” (347).

Image quality can be set by pressing the **QUAL** button and rotating the main command dial until the desired setting is displayed in the information display.

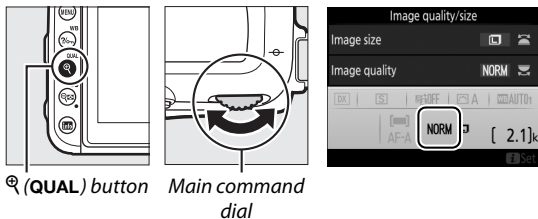

JPEG Compression

Image quality options with a star (“★”) use compression intended to ensure maximum quality; the size of the files varies with the scene. Options without a star use a type of compression designed to produce smaller files; files tend to be roughly the same size regardless of the scene recorded.

NEF (RAW) Images

Selecting an NEF (RAW) option fixes image size at **Large**. JPEG copies of NEF (RAW) images can be created using Capture NX-D or other software or the **NEF (RAW) processing** option in the retouch menu (☐ 275).

NEF+JPEG

When photographs taken at NEF (RAW) + JPEG are viewed on the camera, only the JPEG image will be displayed. When photographs taken at these settings are deleted, both NEF and JPEG images will be deleted.

The Photo Shooting Menu

Image quality can also be adjusted using the **Image quality** option in the photo shooting menu (☐ 253).

Image Size

Image size is measured in pixels. Choose from **L** Large, **M** Medium, or **S** Small (note that image size varies depending on the option selected for **Choose image area**, [p 93](#)):

Image area	Option	Size (pixels)
DX (24×16)	Large	5568 × 3712
	Medium	4176 × 2784
	Small	2784 × 1856
1.3× (18×12)	Large	4272 × 2848
	Medium	3200 × 2136
	Small	2128 × 1424

Image size can be set by pressing the **QUAL** button and rotating the sub-command dial until the desired setting is displayed in the information display.

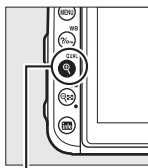

QUAL button

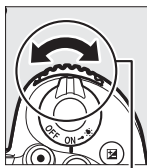

Sub-command dial

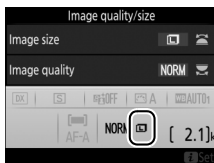

The Photo Shooting Menu

Image size can also be adjusted using the **Image size** option in the photo shooting menu ([p 253](#)).

Focus

Focus can be adjusted automatically (📖 100) or manually (📖 115). The user can also select the focus point for automatic or manual focus (📖 107) or use focus lock to focus and recompose photographs after focusing (📖 111).

Autofocus

To use autofocus, rotate the focus-mode selector to **AF**.

Focus-mode selector

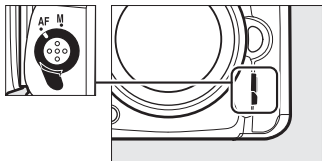

Autofocus Mode

The following autofocus modes can be selected during viewfinder photography:

Mode	Description
AF-A	Auto-servo AF: Camera automatically selects single-servo autofocus if subject is stationary, continuous-servo autofocus if subject is moving.
AF-S	Single-servo AF: For stationary subjects. Focus locks when shutter-release button is pressed halfway. At default settings, shutter can only be released when in-focus indicator (●) is displayed (<i>focus priority</i> ; 📖 260).
AF-C	Continuous-servo AF: For moving subjects. Camera focuses continuously while shutter-release button is pressed halfway; if subject moves, camera will engage <i>predictive focus tracking</i> (📖 102) to predict final distance to subject and adjust focus as necessary. At default settings, shutter can be released whether or not subject is in focus (<i>release priority</i> ; 📖 260).

The following autofocus modes can be selected during live view:

Mode	Description
AF-S	Single-servo AF: For stationary subjects. Focus locks when shutter-release button is pressed halfway. You can also focus by touching your subject in the monitor, in which case focus locks until you lift your finger from the display to take the photograph.
AF-F	Full-time servo AF: For moving subjects. Camera focuses continuously until shutter-release button is pressed. Focus locks when shutter-release button is pressed halfway. You can also focus by touching your subject in the monitor, in which case focus locks until you lift your finger from the display to take the photograph.

Autofocus mode can be selected by pressing the AF-mode button and rotating the main command dial until the desired setting is displayed.

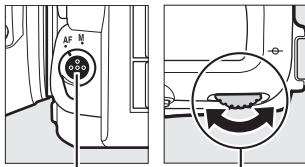

AF-mode button

Main command dial

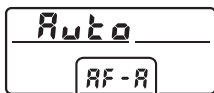

Control panel



Viewfinder









Monitor

Predictive Focus Tracking (Viewfinder Photography)

In **AF-C** mode or when continuous-servo autofocus is selected in **AF-A** mode, the camera will initiate predictive focus tracking if the subject moves toward or away from the camera while the shutter-release button is pressed halfway. This allows the camera to track focus while attempting to predict where the subject will be when the shutter is released.

See Also

For information on:

- Using focus priority in continuous-servo AF, see  > Custom Setting a1 (**AF-C priority selection**,  260).
- Using release priority in single-servo AF, see  > Custom Setting a2 (**AF-S priority selection**,  260).
- Using the sub-command dial to choose the focus mode, see  > Custom Setting f3 (**Customize command dials**) > **Change main/sub** ( 266).

AF-Area Mode

AF-area mode controls how the camera selects the focus-point for autofocus. The following options are available during viewfinder photography:

- **Single-point AF:** Select the focus point; the camera will focus on the subject in the selected focus point only. Use with stationary subjects.
- **Dynamic-area AF:** Select the focus point. In **AF-A** and **AF-C** focus modes, the camera will focus based on information from surrounding focus points if the subject briefly leaves the selected point. The number of focus points varies with the mode selected:
 - **9-point dynamic-area AF:** Choose when there is time to compose the photograph or when photographing subjects that are moving predictably (e.g., runners or race cars on a track).
 - **21-point dynamic-area AF:** Choose when photographing subjects that are moving unpredictably (e.g., players at a football game).
 - **51-point dynamic-area AF:** Choose when photographing subjects that are moving quickly and can not be easily framed in the viewfinder (e.g., birds).

- **3D-tracking:** Select the focus point. In **AF-A** and **AF-C** focus modes, the camera will track subjects that leave the selected focus point and select new focus points as required. Use to quickly compose pictures with subjects that are moving erratically from side to side (e.g., tennis players). If the subject leaves viewfinder, remove your finger from the shutter-release button and recompose the photograph with the subject in the selected focus point.



- **Group-area AF:** The camera focuses using a group of focus points selected by the user, reducing the risk of the camera focusing on the background instead of on the main subject. Choose for subjects that are difficult to photograph using a single focus point. If faces are detected in single-servo AF (**AF-S** or single-servo AF selected in **AF-A**), the camera will give priority to portrait subjects.

- **Auto-area AF:** The camera automatically detects the subject and selects the focus point (in the case of portrait subjects, the camera is able to distinguish the subject from the background for improved subject detection). The active focus points are highlighted briefly after the camera focuses; in **AF-C** and **AF-A** modes, the main focus point remains highlighted after the other focus points have turned off.



🔍 3D-tracking

When the shutter-release button is pressed halfway, the colors in the area surrounding the focus point are stored in the camera.

Consequently 3D-tracking may not produce the desired results with subjects that are similar in color to the background or that occupy a very small area of the frame.

AF-area mode can be selected by pressing the AF-mode button and rotating the sub-command dial until the desired setting is displayed.

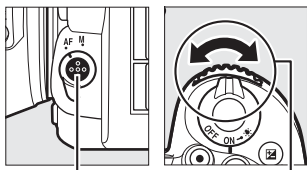

AF-mode button

Sub-command dial

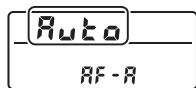

Control panel

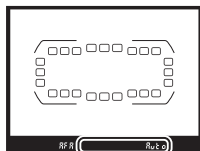



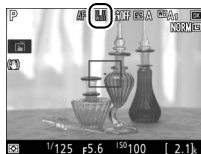











Viewfinder



Monitor

AF-Area Mode (Viewfinder Photography)

AF-area mode is shown in the control panel and viewfinder.

AF-area mode	Control panel	Viewfinder	Viewfinder focus-point display
Single-point AF	S		
9-point dynamic-area AF *	d 9		
21-point dynamic-area AF *	d2 1		
51-point dynamic-area AF *	d5 1		
3D-tracking	3d		
Group-area AF	Gr P		
Auto-area AF	Auto		

* Only active focus point is displayed in the viewfinder. Remaining focus points provide information to assist focus operation.

AF-S/AF-I Teleconverters (Viewfinder Photography)

If 3D-tracking or auto-area AF is selected for AF-area mode when an AF-S/AF-I teleconverter is used, single-point AF will automatically be selected at combined apertures slower than f/5.6.

✔ Using Autofocus in Live View

Use an AF-S or AF-P lens. The desired results may not be achieved with other lenses or teleconverters. Note that in live view, autofocus is slower and the monitor may brighten or darken while the camera focuses. The focus point may sometimes be displayed in green when the camera is unable to focus. The camera may be unable to focus in the following situations:

- The subject contains lines parallel to the long edge of the frame
- The subject lacks contrast
- The subject in the focus point contains areas of sharply contrasting brightness, or includes spot lighting or a neon sign or other light source that changes in brightness
- Flicker or banding appears under fluorescent, mercury-vapor, sodium-vapor, or similar lighting
- A cross (star) filter or other special filter is used
- The subject appears smaller than the focus point
- The subject is dominated by regular geometric patterns (e.g., blinds or a row of windows in a skyscraper)
- The subject is moving

✎ Focus-Point Selection

Except in subject-tracking AF, pressing **OK** during focus-point selection selects the center focus point. In subject-tracking AF, pressing **OK** starts subject tracking instead. Manual focus-point selection is not available in auto-area AF.

✎ See Also

Viewfinder photography—For information on:

- Choosing the number of focus points that can be selected using the multi selector, see **✎ > Custom Setting a4 (Number of focus points, □ 260)**.
- Choosing separate focus points for vertical and horizontal orientations, see **✎ > Custom Setting a5 (Store points by orientation, □ 261)**.
- Setting focus-point selection to “wrap around,” see **✎ > Custom Setting a7 (Focus point wrap-around, □ 261)**.

Viewfinder photography/live view: For information on using the main command dial to choose the AF-area mode, see **✎ > Custom Setting f3 (Customize command dials) > Change main/sub (□ 266)**.

2 Lock focus.

AF-A and AF-C focus modes (viewfinder photography): With the shutter-release button pressed halfway (①), press the AE-L/AF-L button (②) to lock both focus and exposure (an **AE-L** icon will be displayed in the viewfinder). Focus will remain locked while the AE-L/AF-L button is pressed, even if you later remove your finger from the shutter-release button.

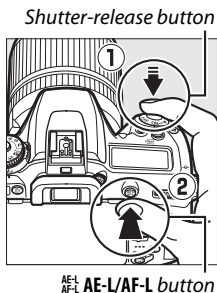

AF-S (viewfinder photography) and live view: Focus locks automatically and remain locked until you remove your finger from the shutter-release button. Focus can also be locked by pressing the AE-L/AF-L button (see above).

3 Recompose the photograph and shoot.

Focus will remain locked between shots if you keep the shutter-release button pressed halfway (**AF-S** and live view) or keep the **AE-L/AF-L** button pressed, allowing several photographs in succession to be taken at the same focus setting.



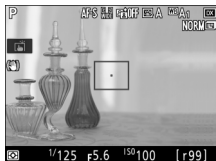

Viewfinder photography



Live view

Do not change the distance between the camera and the subject while focus lock is in effect. If the subject moves, focus again at the new distance.

See Also

For information on using the shutter-release button to lock exposure, see  > Custom Setting c1 (**Shutter-release button AE-L**,  262).

Getting Good Results with Autofocus

Autofocus does not perform well under the conditions listed below. The shutter release may be disabled if the camera is unable to focus under these conditions, or the in-focus indicator (●) may be displayed and the camera may sound a beep, allowing the shutter to be released even when the subject is not in focus. In these cases, focus manually (☐ 115) or use focus lock (☐ 111) to focus on another subject at the same distance and then recompose the photograph.

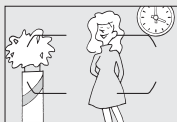

There is little or no contrast between the subject and the background.

Example: Subject is the same color as the background.



The focus point contains objects at different distances from the camera.

Example: Subject is inside a cage.



The subject is dominated by regular geometric patterns.

Example: Blinds or a row of windows in a skyscraper.

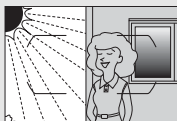

The focus point contains areas of sharply contrasting brightness.

Example: Subject is half in the shade.



Background objects appear larger than the subject.

Example: A building is in the frame behind the subject.

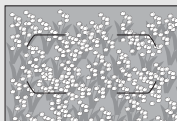

The subject contains many fine details.

Example: A field of flowers or other subjects that are small or lack variation in brightness.

Manual Focus

Manual focus is available for lenses that do not support autofocus (non-AF NIKKOR lenses) or when the autofocus does not produce the desired results (📖 114).

- **AF lenses:** Set the lens focus mode switch (if present) and camera focus-mode selector to **M**.

Focus-mode selector

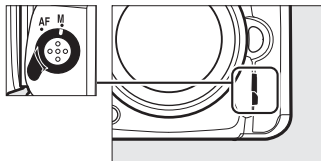

✓ AF Lenses

Do not use AF lenses with the lens focus mode switch set to **M** and the camera focus-mode selector set to **AF**. Failure to observe this precaution could damage the camera or lens. This does not apply to AF-S lenses, which can be used in **M** mode without setting the camera focus-mode selector to **M**.

- **Manual focus lenses:** Focus manually.

To focus manually, adjust the lens focus ring until the subject is in focus. Photographs can be taken at any time, even when the image is not in focus.

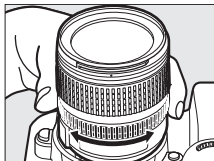

■ The Electronic Rangefinder (Viewfinder Photography)

The viewfinder focus indicator can be used to confirm whether the subject in the selected focus point is in focus (the focus point can be selected from any of the 51 focus points). After positioning the subject in the selected focus point, press the shutter-release button halfway and rotate the lens focus ring until the in-focus indicator (●) is displayed. Note that with the subjects listed in “Getting Good Results with Autofocus” (□ 114), the in-focus indicator may sometimes be displayed when the subject is not in focus; confirm focus in the viewfinder before shooting. For information on using the electronic rangefinder with optional AF-S/AF-I teleconverters, see “AF-S/AF-I Teleconverters” (□ 281).



✍ AF-P Lenses

When an AF-P lens (□ 279) is used in manual focus mode, the in-focus indicator will flash in the viewfinder (or in live view, the focus point will flash in the monitor) to warn that continuing to rotate the focus ring in the current direction will not bring the subject into focus.

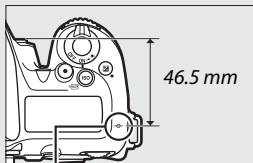

✍ Focal Plane Position

To determine the distance between your subject and the camera, measure from the focal plane mark (⊖) on the camera body. The distance between the lens mounting flange and the focal plane is 46.5 mm (1.83 in.).



Focal plane mark

Live View

Press the  (**QUAL**) button to zoom in for precise focus in live view ( 57).

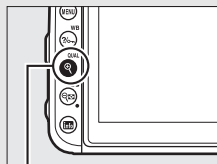

 (**QUAL**) button

ISO Sensitivity

The camera's sensitivity to light can be adjusted according to the amount of light available.

ISO Sensitivity Settings

Choose from settings that range from ISO 100 and ISO 51200 in steps equivalent to $\frac{1}{3}$ EV. Settings of from about 0.3 to 1 EV below ISO 100 and 0.3 to 5 EV above ISO 51200 are also available for special situations. Auto, scene, and special effect modes also offer an **AUTO** option, which allows the camera to set ISO sensitivity automatically in response to lighting conditions.

Modes	Options
P, S, A, M	Lo 1–Lo 0.3; 100–51200; Hi 0.3–Hi 5
	Auto
Other shooting modes	Auto; Lo 1–Lo 0.3; 100–51200; Hi 0.3–Hi 5

ISO sensitivity can be adjusted by pressing the **ISO** () button and rotating the main command dial until the desired setting is displayed.

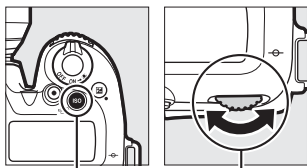

ISO () button

Main command dial



Control panel



Viewfinder

The Photo Shooting Menu

ISO sensitivity can also be adjusted from the photo shooting menu. Choose **ISO sensitivity settings** in photo shooting menu to adjust settings for photographs (☞ 253).

Live View

In live view, the selected value is displayed in the monitor.

ISO Sensitivity

The higher the ISO sensitivity, the less light needed to make an exposure, allowing faster shutter speeds or smaller apertures, but the more likely the image is to be affected by noise (randomly-spaced bright pixels, fog, or lines). Noise is particularly likely at settings between **Hi 0.3** and **Hi 5**.

Hi 0.3–Hi 5



The settings **Hi 0.3** through **Hi 5** correspond to ISO sensitivities 0.3–5 EV over ISO 51200 (ISO 64000–1640000 equivalent).

Lo 0.3–Lo 1

The settings **Lo 0.3** through **Lo 1** correspond to ISO sensitivities 0.3–1 EV below ISO 100 (ISO 80–50 equivalent). Use for larger apertures when lighting is bright. Contrast is slightly higher than normal; in most cases, ISO sensitivities of ISO 100 or above are recommended.

See Also

For information on:

- Choosing the ISO sensitivity step size, see  > Custom Setting b1 (**ISO sensitivity step value**; ☞ 261).
- Reducing noise in photos taken at high ISO sensitivities, see  > **High ISO NR** (☞ 255).
- Reducing noise in movies shot at high ISO sensitivities, see  > **High ISO NR** (☞ 259).

Auto ISO Sensitivity Control

(P, S, A, and M Modes Only)

If **On** is selected for **ISO sensitivity settings** > **Auto ISO sensitivity control** in the photo shooting menu, ISO sensitivity will automatically be adjusted if optimal exposure can not be achieved at the value selected by the user (ISO sensitivity is adjusted appropriately when the flash is used).

- 1 Select Auto ISO sensitivity control.**
Select **ISO sensitivity settings** in the photo shooting menu, highlight **Auto ISO sensitivity control** and press \odot .

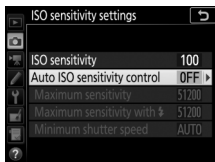

- 2 Select On.**
Highlight **On** and press \odot (if **Off** is selected, ISO sensitivity will remain fixed at the value selected by the user).

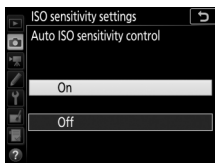

3 Adjust settings.

The maximum value for auto ISO sensitivity can be selected using **Maximum sensitivity** (the minimum value for auto ISO sensitivity is automatically set to ISO 100; note that if the ISO sensitivity selected by the user is higher than that chosen for **Maximum sensitivity**, the value selected by the user will be used instead). In modes **P** and **A**, sensitivity will only be adjusted if underexposure would result at the shutter speed selected for **Minimum shutter speed** ($1/4000$ –30 s, or **Auto**; in modes **S** and **M**, ISO sensitivity will be adjusted for optimal exposure at the shutter speed selected by the user). If **Auto** is selected, the camera will choose the minimum shutter speed based on the focal length of the lens; choosing fast speeds when photographing fast-moving subjects reduces blur. Press **OK** to exit when settings are complete.

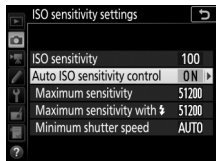

To choose the maximum ISO sensitivity for photos taken using the built-in flash or an optional flash unit, use **Maximum sensitivity with \downarrow** . Selecting **Same as without flash** sets the maximum ISO sensitivity for flash photography to the value currently selected for **Maximum sensitivity**.

ISO AUTO is displayed when **On** is selected. When sensitivity is altered from the value selected by the user, these indicators flash and the altered value is shown in the control panel.

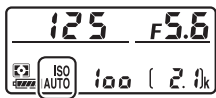



Live View

In live view, the auto ISO sensitivity control indicator is displayed in the monitor.

Minimum Shutter Speed

Auto shutter-speed selection can be fine-tuned by highlighting **Auto** and pressing : for example, values faster than those usually selected automatically can be used with telephoto lenses to reduce blur. Note, however, that **Auto** functions only with CPU lenses. Shutter speeds may drop below the selected minimum if optimum exposure can not be achieved at the ISO sensitivity chosen for **Maximum sensitivity**.

Auto ISO Sensitivity Control

When a flash is used, minimum shutter speed will be set to the value selected for **Minimum shutter speed** unless this value is faster than Custom Setting e1 (**Flash sync speed**,  265) or slower than Custom Setting e2 (**Flash shutter speed**,  265), in which case the value selected for Custom Setting e2 will be used instead. Note that ISO sensitivity may be raised automatically when auto ISO sensitivity control is used in combination with slow sync flash modes (available with the built-in flash and compatible optional flash units), possibly preventing the camera from selecting slow shutter speeds.

Enabling and Disabling Auto ISO Sensitivity Control





You can turn auto ISO sensitivity control on or off by pressing the **ISO** () button and rotating the sub-command dial. **ISO AUTO** is displayed when auto ISO sensitivity control is on.

Exposure

Metering

(P, S, A, and M Modes Only)

Choose how the camera sets exposure in **P**, **S**, **A**, and **M** modes (in other modes, the camera selects the metering method automatically).

Option	Description
	Matrix: Produces natural results in most situations. Camera meters wide area of the frame and set exposure according to tone distribution, color, composition, and, with type G, E, or D lenses (□ 280), distance information (3D color matrix metering III; with other CPU lenses, camera uses color matrix metering III, which does not include 3D distance information).
	Center-weighted: Camera meters entire frame but assigns greatest weight to center area (size of area for viewfinder photography can be selected using Custom Setting b5, Center-weighted area , □ 262). Classic meter for portraits; recommended when using filters with an exposure factor (filter factor) over 1×.
	Spot: Camera meters circle centered on current focus point, making it possible to meter off-center subjects (if auto-area AF is in effect, camera will meter center focus point). Diameter of circle for viewfinder photography is 3.5 mm (0.14 in.), or approximately 2.5% of frame. Ensures that subject will be correctly exposed, even when background is much brighter or darker.
	Highlight-weighted: Camera assigns greatest weight to highlights. Use to reduce loss of detail in highlights, for example when photographing spotlight performers on-stage.

To choose a metering option, press the  button and rotate the main command dial until the desired setting is displayed.

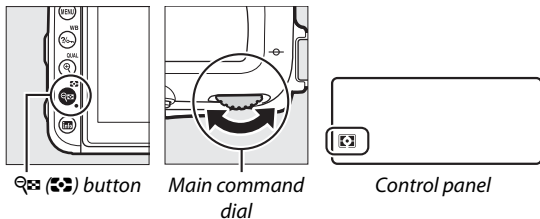

Live View





In live view, the selected option is displayed in the monitor.

Highlight-Weighted Metering

Center-weighted metering may be used if highlight-weighted metering is selected with certain CPU lenses (AI-P NIKKOR lenses and AF lenses that are not of type G, E, or D;  280).

See Also

For information on:

- Choosing whether matrix metering uses face detection, see  > Custom Setting b4 (**Matrix metering**,  262).
- Making separate adjustments to optimal exposure for each metering method, see  > Custom Setting b6 (**Fine-tune optimal exposure**,  262).

Autoexposure Lock

Use autoexposure lock to recompose photographs after using center-weighted metering and spot metering (📖 123) to meter exposure.

1 Lock exposure.

Position the subject in the selected focus point and press the shutter-release button halfway. With the shutter-release button pressed halfway and the subject positioned in the focus point, press the $\overset{\text{AE-L}}{\text{AF-L}}$ **AE-L/AF-L** button to lock exposure (if you are using autofocus, confirm that the ● in-focus indicator appears in the viewfinder).

While exposure lock is in effect, an **AE-L** indicator will appear in the viewfinder and the monitor.

Shutter-release button

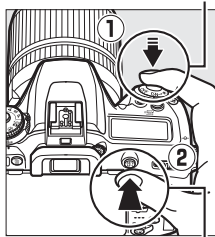

$\overset{\text{AE-L}}{\text{AF-L}}$ **AE-L/AF-L** button

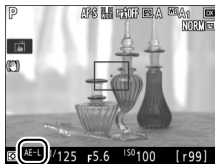

- 2** **Recompose the photograph.**
Keeping the AE-L/AF-L button pressed, recompose the photograph and shoot.

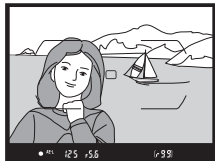

Spot Metering

In spot metering, exposure will be locked at the value metered at the selected focus point.

Adjusting Shutter Speed and Aperture



While exposure lock is in effect, the following settings can be adjusted without altering the metered value for exposure:

Mode	Setting
P	Shutter speed and aperture (flexible program;  73)
S	Shutter speed
A	Aperture

The new values can be confirmed in the camera displays.

Note that metering can not be changed while exposure lock is in effect.

See Also

For information on using the shutter-release button to lock exposure, see  > Custom Setting c1 (**Shutter-release button AE-L**,  262). If **On (half press)** is selected, exposure will lock when the shutter-release button is pressed halfway.

Exposure Compensation

(P, S, A, M, SCENE, and EFFECTS Modes Only)

Exposure compensation is used to alter exposure from the value suggested by the camera, making pictures brighter or darker. It is most effective when used with center-weighted or spot metering (☐ 123). Choose from values between -5 EV (underexposure) and $+5$ EV (overexposure) in increments of $\frac{1}{3}$ EV. In general, positive values make the subject brighter while negative values make it darker.



-1 EV

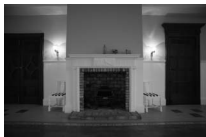

No exposure
compensation



$+1$ EV

To choose a value for exposure compensation, press the  button and rotate the main command dial until the desired value is displayed.

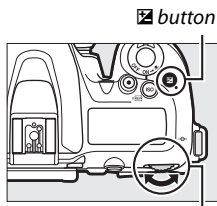

Main command dial



± 0 EV



( button pressed)



-0.3 ($-\frac{1}{3}$) EV



$+2.0$ EV

At values other than ± 0.0 , the 0 at the center of the exposure indicators will flash (except in mode **M**) and a  icon will be displayed in the control panel and viewfinder after you release the  button. The current value for exposure compensation can be confirmed in the exposure indicator by pressing the  button.



Normal exposure can be restored by setting exposure compensation to ± 0 . Except in **SCENE** and **EFFECTS** modes, exposure compensation is not reset when the camera is turned off (in **SCENE** and **EFFECTS** modes, exposure compensation will be reset when another mode is selected or the camera is turned off).

Mode M







In mode **M**, exposure compensation affects only the exposure indicator; shutter speed and aperture do not change.

Flash Photography

When a flash is used, exposure compensation affects both flash level and exposure, altering the brightness of both the main subject and the background. Custom Setting e3 (**Exposure comp. for flash**,  265) can be used to restrict the effects of exposure compensation to the background only.

See Also

For information on:

- Choosing the size of the increments available for exposure compensation, see  > Custom Setting b2 (**EV steps for exposure ctrl**,  262).
- Making adjustments to exposure compensation without pressing the  button, see  > Custom Setting b3 (**Easy exposure compensation**,  262).
- Automatically varying exposure, flash level, white balance, or Active D-Lighting, see “Bracketing” ( 209).



White Balance





(P, S, A, and M Modes Only)

White balance ensures that colors are unaffected by the color of the light source.

White Balance Options

In modes other than **P**, **S**, **A**, and **M**, white balance is set automatically by the camera. Auto white balance is recommended for most light sources in **P**, **S**, **A**, and **M** modes, but other values can be selected if necessary according to the type of source:

Option (Color temp.°)	Description
AUTO Auto	White balance is adjusted automatically. For best results, use type G, E or D lens. If flash fires, results are adjusted appropriately.
Normal (3500–8000 K)	
Keep warm lighting colors (3500–8000 K)	
 Incandescent (3000 K)	Use under incandescent lighting.
 Fluorescent	Use with:
Sodium-vapor lamps (2700 K)	• Sodium-vapor lighting (found in sports venues).
Warm-white fluorescent (3000 K)	• Warm-white fluorescent lights.
White fluorescent (3700 K)	• White fluorescent lights.
Cool-white fluorescent (4200 K)	• Cool-white fluorescent lights.
Day white fluorescent (5000 K)	• Daylight white fluorescent lights.
Daylight fluorescent (6500 K)	• Daylight fluorescent lights.
High temp. mercury-vapor (7200 K)	• High color temperature light sources (e.g. mercury-vapor lamps).

Option (Color temp. °)	Description
 Direct sunlight (5200 K)	Use with subjects lit by direct sunlight.
 Flash (5400 K)	For flash photography.
 Cloudy (6000 K)	Use in daylight under overcast skies.
 Shade (8000 K)	Use in daylight with subjects in the shade.
 Choose color temp. (2500–10,000 K)	Choose color temperature from list of values (☞ 137).
PRE Preset manual	Use subject, light source, or existing photograph as reference for white balance (☞ 139).

* All values are approximate and do not reflect fine-tuning (if applicable).

White balance is set by pressing the  (WB) button and rotating the main command dial until the desired setting is displayed.

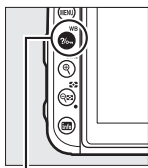

 (WB) button



Main command dial

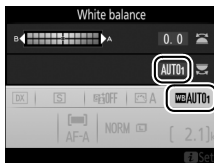

Live View

In live view, the selected option is displayed in the monitor.

The Shooting Menus

White balance can also be adjusted using the **White balance** option in the photo or movie shooting menu (☐ 254, 258), which also can be used to fine-tune white balance (☐ 134) or manage white-balance presets (☐ 139). The **Auto** option in the **White balance** menu offers a choice of **Normal** and **Keep warm lighting colors**, which preserves the warm colors produced by incandescent lighting, while the  **Fluorescent** option can be used to select the light source from the bulb types.

Studio Flash Lighting



Auto white balance may not produce the desired results with large studio flash units. Use preset manual white balance or set white balance to **Flash** and use fine tuning to adjust white balance.

Color Temperature

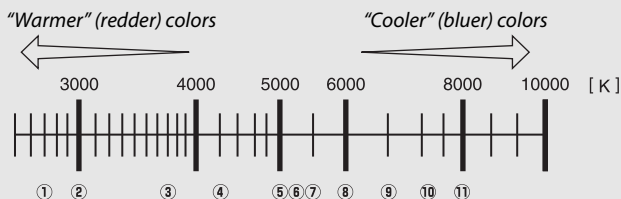
The perceived color of a light source varies with the viewer and other conditions. Color temperature is an objective measure of the color of a light source, defined with reference to the temperature to which an object would have to be heated to radiate light in the same wavelengths. While light sources with a color temperature in the neighborhood of 5000–5500 K appear white, light sources with a lower color temperature, such as incandescent light bulbs, appear slightly yellow or red. Light sources with a higher color temperature appear tinged with blue.





①  (sodium-vapor lamps): 2700 K

②  (incandescent)/ (warm-white fluorescent.): 3000 K

③  (white fluorescent): 3700 K

④  (cool-white fluorescent): 4200 K

⑤  (day white fluorescent): 5000 K

⑥  (direct sunlight): 5200 K

⑦  (flash): 5400 K

⑧  (cloudy): 6000 K

⑨  (daylight fluorescent): 6500 K

⑩  (high temp. mercury-vapor): 7200 K

⑪  (shade): 8000 K

Note: All figures are approximate.



Fine-Tuning White Balance

At settings other than  (**Choose color temp.**), white balance can be “fine-tuned” to compensate for variations in the color of the light source or to introduce a deliberate color cast into an image.

■ The White Balance Menu

To fine-tune white balance from the photo shooting menu, select **White balance** and follow the steps below.

1 Display fine-tuning options.

Highlight a white balance option and press  (if a sub-menu is displayed, select the desired option and press  again to display fine-tuning options; for information on fine-tuning preset manual white balance, see “Fine-Tuning Preset Manual White Balance”,  147).

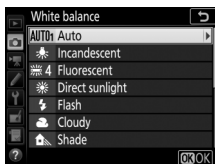

2 Fine tune white balance.

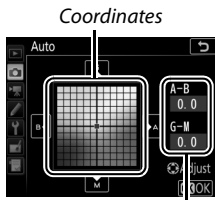

Use the multi selector to fine-tune white balance. White balance can be fine-tuned on the amber (A)–blue (B) axis in steps of 0.5 and the green (G)–magenta (M) axis in steps of 0.25. The horizontal (amber–blue) axis corresponds to color temperature, while the vertical (green–magenta) axis has the similar effects to the corresponding color compensation (CC) filters. The horizontal axis is ruled in increments equivalent to about 5 mired, the vertical axis in increments of about 0.05 diffuse density units.





3 Press .

Press  to save settings and return to the photo shooting menu.

■ The (WB) Button

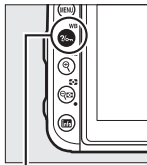
At settings other than  (Choose color temp.) and PRE (Preset manual), the  (WB) button can be used to fine-tune white balance on the amber (A)–blue (B) axis (□ 134; to fine-tune white balance when PRE is selected, use the shooting menus as described in “Fine-



 (WB) button

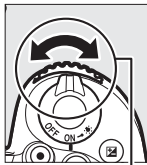

Sub-command dial

Tuning Preset Manual White Balance”, □ 147). Press the  (WB) button and rotate the sub-command dial to fine-tune white balance in steps of 0.5 (with each full increment equivalent to about 5 mired) until the desired value is displayed. Rotating the sub-command dial to the left increases the amount of amber (A). Rotating the sub-command dial to the right increases the amount of blue (B).



Control panel

Live View

In live view, the selected value is displayed in the monitor.

White Balance Fine-Tuning

If white balance has been fine-tuned, an asterisk (“*”) will be displayed next to the white balance setting. Note that the colors on the fine-tuning axes are relative, not absolute. For example, moving the cursor to **B** (blue) when a “warm” setting such as  (Incandescent) is selected for white balance will make photographs slightly “colder” but will not actually make them blue.

“Mired”

Any given change in color temperature produces a greater difference in color at low color temperatures than it would at higher color temperatures. For example, a change of 1000 K produces a much greater change in color at 3000 K than at 6000 K. Mired, calculated by multiplying the inverse of the color temperature by 10^6 , is a measure of color temperature that takes such variation into account, and as such is the unit used in color-temperature compensation filters. E.g.:

- 4000 K–3000 K (a difference of 1000 K)=83 mired
- 7000 K–6000 K (a difference of 1000 K)=24 mired

See Also

For information on varying white balance to “bracket” the current value, see “Bracketing” (□ 215).

Choosing a Color Temperature

Follow the steps below to choose a color temperature when **☑ (Choose color temp.)** is selected for white balance.

☑ Choose Color Temperature

Note that the desired results will not be obtained with flash or fluorescent lighting. Choose **⚡ (Flash)** or **☀ (Fluorescent)** for these sources. With other light sources, take a test shot to determine if the selected value is appropriate.

■ The White Balance Menu

Color temperature can be selected using the **White balance** options in the photo shooting menu. Enter values for the amber–blue and green–magenta axes (☞ 134) as described below.

1 Select **Choose color temp.**

Select **White balance** in the photo shooting menu, then highlight **Choose color temp.** and press **⏎**.

2 Select values for amber–blue and green–magenta.

Press **⏪** or **⏩** to highlight digits on the amber (A)–blue (B) axis or the green (G)–magenta (M) axis and press **⏴** or **⏵** to change.

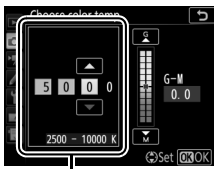

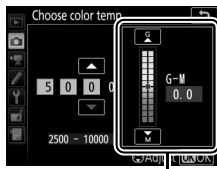

Value for amber (A)–
blue (B) axis











Value for green (G)–
magenta (M) axis

3 Press .

Press  to save changes and return to the shooting menus. If a value other than 0 is selected for the green (G)–magenta (M) axis, an asterisk (“*”) will be displayed next to the  icon.

The (WB) Button

When  (**Choose color temp.**) is selected, the  (WB) button can be used to select the color temperature, although only for the amber (A)–blue (B) axis. Press the  (WB) button and rotate the sub-command dial until the desired value is displayed (adjustments are made in mireds;  136). To enter a color temperature directly, press the  (WB) button and press  or  to highlight a digit and press  or  to change.

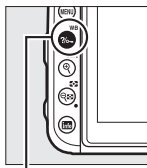

 (WB) button

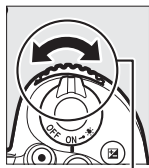

Sub-command dial





Control panel

Live View

In live view, the selected value is displayed in the monitor.

Preset Manual

Preset manual is used to record and recall custom white balance settings for shooting under mixed lighting or to compensate for light sources with a strong color cast. The camera can store up to six values for preset manual white balance in presets d-1 through d-6. Two methods are available for setting preset manual white balance:

Method	Description
Direct measurement	Neutral gray or white object is placed under lighting that will be used in final photograph and white balance measured by camera. During live view, white balance can be measured in a selected area of the frame (spot white balance,  143).
Copy from existing photograph	White balance is copied from photo on memory card ( 146).

Viewfinder Photography

1 Light a reference object.

Place a neutral gray or white object under the lighting that will be used in the final photograph. In studio settings, a standard gray panel can be used as a reference object. Note that exposure is automatically increased by 1 EV when measuring white balance; in mode **M**, adjust exposure so that the exposure indicator shows ± 0 ( 77).

2 Set white balance to PRE (Preset manual).

Press the **WB** button and rotate the main command dial until **PRE** is displayed in the information display.

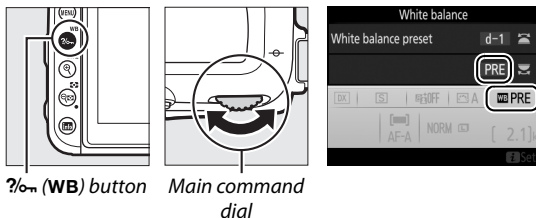

3 Select a preset.

Press the **WB** button and rotate the sub-command dial until the desired white balance preset (d-1 to d-6) is displayed in the information display.



Measuring Preset Manual White Balance (Viewfinder Photography)

Preset manual white balance can not be measured during time-lapse movie recording or while you are shooting an HDR photograph (155) or multiple exposure (256).

4 Select direct measurement mode.

Release the $\frac{1}{60}$ (WB) button briefly and then press the button until PrE starts to flash in the control panel and viewfinder.

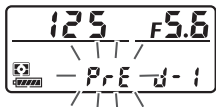

5 Measure white balance.

In the few seconds before the indicators stop flashing, frame the reference object so that it fills the viewfinder and press the shutter-release button all the way down. The camera will measure a value for white balance and store it in the preset selected in Step 3. No photograph will be recorded; white balance can be measured accurately even when the camera is not in focus.



Protected Presets

If the current preset is protected (🔒 147), PrE will flash in the control panel and viewfinder if you attempt to measure a new value.

6 Check the results.

If the camera was able to measure a value for white balance, **Good** will flash in the control panel, while the viewfinder will show a flashing **Gd**. Press the shutter-release button halfway to exit to shooting mode.

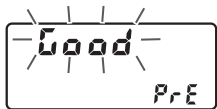

If lighting is too dark or too bright, the camera may be unable to measure white balance. A flashing **no Gd** will appear in the control panel and viewfinder. Press the shutter-release button halfway to return to Step 5 and measure white balance again.

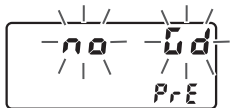

✓ Direct Measurement Mode

If no operations are performed during viewfinder photography while the displays are flashing, direct measurement mode will end in the time selected for Custom Setting c2 (**Standby timer**, □ 263).

✎ Selecting a Preset

Selecting **Preset manual** for the **White balance** option in the photo shooting menu displays white balance presets; highlight a preset and press **OK**. If no value currently exists for the selected preset, white balance will be set to 5200 K, the same as **Direct sunlight**.



Live View (Spot White Balance)

During live view, white balance can be measured in a selected area of the frame, eliminating the need to prepare a reference object or change lenses during telephoto photography.

1 Press the button.

The mirror will be raised and the view through the lens will be displayed in the camera monitor.

2 Set white balance to PRE (Preset manual).

Press the  (**WB**) button and rotate the main command dial until **PRE** is displayed in the monitor.

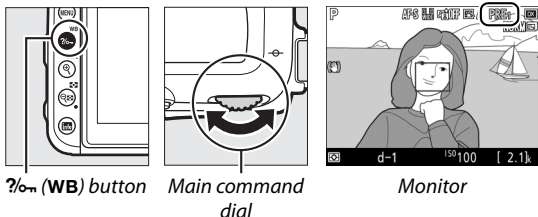

3 Select a preset.

Press the **WB** button and rotate the sub-command dial until the desired white balance preset (d-1 to d-6) is displayed in the monitor.

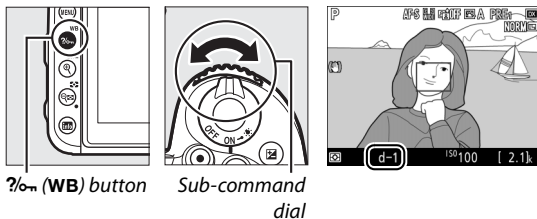

4 Select direct measurement mode.

Release the **WB** button briefly and then press the button until the **PRE** icon in the monitor starts to flash. A spot white balance target (□) will be displayed at the selected focus point.



5 Position the target over a white or grey area.

While **PRE** flashes in the display, use the multi selector to position the □ over a white or grey area of the subject. To zoom the area around the target in for more precise positioning, press the **QUAL** button. You can also measure white balance anywhere in the frame by tapping your subject in the monitor, in which case there is no need to press the **OK** or shutter-release button as described in Step 6.



6 Measure white balance.

Press **OK** or press the shutter-release button all the way down to measure white balance. The time available to measure white balance is that selected for Custom Setting c4 (**Monitor off delay**) > **Live view** (☞ 263).

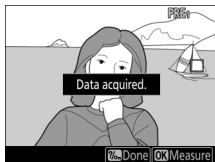

If the camera is unable to measure white balance, a message will be displayed. Choose a new white balance target and repeat the process from Step 5.



7 Exit direct measurement mode.

Press the **WB** button to exit direct measurement mode.

White balance presets can be viewed by selecting **Preset manual** for **White balance** in the photo or movie shooting menu. The position of the targets used to measure preset white balance is displayed on presets recorded during live view.

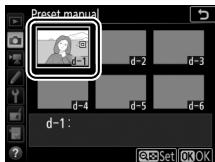

Measuring Preset Manual White Balance (Live View)

Preset manual white balance can not be set while an HDR exposure is in progress (☞ 155).

Managing Presets

■ Copying White Balance from a Photograph



Follow the steps below to copy a value for white balance from an existing photograph to a selected preset.

1 Select Preset manual.

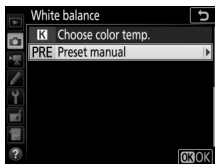
Select **White balance** in the photo shooting menu, then highlight **Preset manual** and press .



2 Select a destination.

Highlight the destination preset (d-1 to d-6) and press  ().

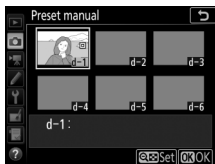

3 Choose Select image.

Highlight **Select image** and press .

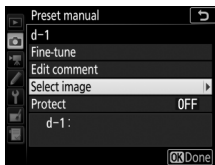

4 Highlight a source image.

Highlight the source image. To view the highlighted image full frame, press and hold the  (**QUAL**) button.

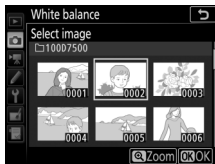

5 Copy white balance.

Press **OK** to copy the white balance value for the highlighted photograph to the selected preset. If the highlighted photograph has a comment (📖 270), the comment will be copied to the comment for the selected preset.

🔍 Fine-Tuning Preset Manual White Balance

The selected preset can be fine-tuned by selecting **Fine-tune** and adjusting white balance as described in “Fine-Tuning White Balance” (📖 134).

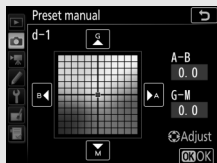

🔍 Edit Comment

To enter a descriptive comment of up to 36 characters for the current white-balance preset, select **Edit comment** in the preset manual white balance menu and enter a comment.



🔍 Protect

To protect the current white-balance preset, select **Protect** in the preset manual white balance menu, then highlight **On** and press **OK**. Protected presets can not be modified and the **Fine-tune** and **Edit comment** options can not be used.

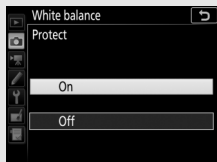

Image Enhancement









Picture Controls

(P, S, A, and M Modes Only)

In **P**, **S**, **A**, and **M** modes, your choice of Picture Control determines how pictures are processed (in other modes, the camera selects a Picture Control automatically).

Selecting a Picture Control

Choose a Picture Control according to the subject or type of scene.

Option	Description
 A Auto	The camera automatically adjusts hues and tones based on the Standard Picture Control. The complexions of portrait subjects will appear softer, and the foliage and sky in outdoor shots more vivid, than in pictures taken with the Standard Picture Control.
 SD Standard	Standard processing for balanced results. Recommended for most situations.
 NL Neutral	Minimal processing for natural results. Choose for photographs that will later be processed or retouched.
 VI Vivid	Pictures are enhanced for a vivid, photoprint effect. Choose for photographs that emphasize primary colors.
 MC Monochrome	Take monochrome photographs.
 PT Portrait	Process portraits for skin with natural texture and a rounded feel.
 LS Landscape	Produces vibrant landscapes and cityscapes.
 FL Flat	Details are preserved over a wide tone range, from highlights to shadows. Choose for photographs that will later be extensively processed or retouched.

1 Select Set Picture Control.

Highlight **Set Picture Control** in the photo shooting menu and press .

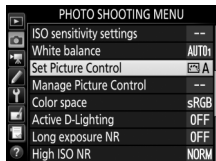

2 Select a Picture Control.

Highlight a Picture Control and press .

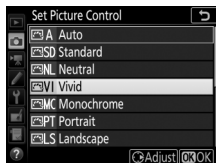

Custom Picture Controls

Custom Picture Controls are created through modifications to existing Picture Controls using the **Manage Picture Control** option in the photo or movie shooting menu (254, 258). Custom Picture Controls can be saved to a memory card for sharing among other cameras of the same model and compatible software.

The Picture Control Indicator

The current Picture Control is shown in the display.

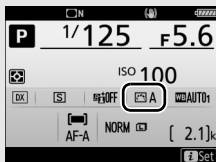

Information display



Shooting display

Modifying Picture Controls





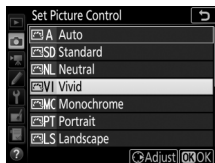

Existing preset or custom Picture Controls (📖 149) can be modified to suit the scene or the user's creative intent. Choose a balanced combination of settings using **Quick adjust**, or make manual adjustments to individual settings.

1 Select a Picture Control.

Highlight the desired Picture Control in the Picture Control list (📖 148) and press .



2 Adjust settings.

Press  or  to highlight the desired setting and press  or  to choose a value in increments of 1, or rotate the sub-command dial to choose a value in increments of 0.25 (📖 151; the options available vary with the Picture Control selected). Repeat this step until all settings have been adjusted, or select a preset combination of settings by highlighting **Quick adjust** and pressing  or . Default settings can be restored by pressing the  button.



3 Press .

Modifications to Original Picture Controls

Picture Controls that have been modified from default settings are indicated by an asterisk ("*").

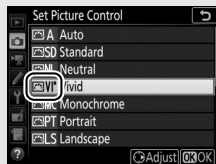

Picture Control Settings

Option	Description	
Quick adjust	Mute or heighten the effect of the selected Picture Control (note that this resets all manual adjustments). Not available with custom Picture Controls (📖 149).	
Manual adjustments	Sharpening	Control the sharpness of outlines. Select A to adjust sharpening automatically according to the type of scene.
	Clarity	Adjust clarity manually or select A to let the camera adjust clarity automatically. Depending on the scene, shadows may appear around bright objects or halos may appear around dark objects at some settings. Clarity is not applied to movies.
	Contrast	Adjust contrast manually or select A to let the camera adjust contrast automatically.
	Brightness	Raise or lower brightness without loss of detail in highlights or shadows.
	Saturation	Control the vividness of colors. Select A to adjust saturation automatically according to the type of scene.
	Hue	Adjust hue.
	Filter effects	Simulate the effect of color filters on monochrome photographs (📖 152).
	Toning	Choose the tint used in monochrome photographs (📖 152).

📌 The “A Auto” Picture Control

If **A Auto** is selected for **Set Picture Control**, settings can be adjusted in the range **A-2** to **A+2**. Rotating the sub-command dial has no effect.

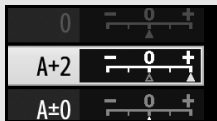

📌 “A” (Auto)

Results for auto sharpening, clarity, contrast, and saturation vary with exposure and the position of the subject in the frame. Use a type G, E, or D lens for best results.

Switching Between Manual and Auto

Press the **Q** (**QUAL**) button to switch back and forth between manual and auto (**A**) settings for sharpening, clarity, contrast, and saturation.

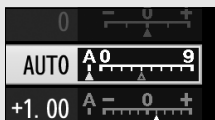

Previous Settings

The **Δ** indicator under the value display in the Picture Control setting menu indicates the previous value for the setting. Use this as a reference when adjusting settings.

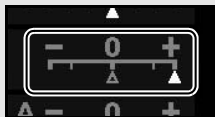

Filter Effects (Monochrome Only)

The options in this menu simulate the effect of color filters on monochrome photographs. The following filter effects are available:

Option	Description
Y Yellow	Enhances contrast. Can be used to tone down the brightness of the sky in landscape photographs. Orange produces more contrast than yellow, red more contrast than orange.
O Orange	
R Red	
G Green	Softens skin tones. Can be used for portraits.

Toning (Monochrome Only)

Pressing **Q** when **Toning** is selected displays saturation options. Press **←** or **→** to adjust saturation. Saturation control is not available when **B&W** (black-and-white) is selected.



Preserving Detail in Highlights and Shadows

(P, S, A, and M Modes Only)

Active D-Lighting

Active D-Lighting preserves details in highlights and shadows, creating photographs with natural contrast. Use for high contrast scenes, for example when photographing brightly lit outdoor scenery through a door or window or taking pictures of shaded subjects on a sunny day. It is most effective when used with matrix metering (☞ 123).



Active D-Lighting off



Active D-Lighting: 暗 A Auto

"Active D-Lighting" versus "D-Lighting"

The **Active D-Lighting** options in the photo and movie shooting menus adjust exposure before shooting to optimize the dynamic range, while the **D-Lighting** option in the retouch menu (☞ 275) brightens shadows in images after shooting.



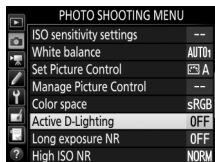

To use Active D-Lighting:

1 Select Active D-Lighting.

Highlight **Active D-Lighting** in the photo shooting menu and press .



2 Choose an option.

Highlight the desired option and press . If  **Auto** is selected, the camera will automatically adjust Active D-Lighting according to shooting conditions (in mode **M**, however,  **Auto** is equivalent to  **Normal**).

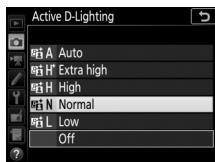

Active D-Lighting

Noise (randomly-spaced bright pixels, fog, or lines) may appear in photographs taken with Active D-Lighting. Uneven shading may be visible with some subjects. Active D-Lighting does not apply at high ISO sensitivities (Hi 0.3–Hi 5).

Active D-Lighting and Movies

If **Same as photo settings** is selected for **Active D-Lighting** in the movie shooting menu and **Auto** is selected in the photo shooting menu, movies will be shot at a setting equivalent to **Normal**. Active D-Lighting does not apply at a frame size of 3840 × 2160.

See Also

For information on varying Active D-Lighting over a series of shots, see “Bracketing” (□ 219).

High Dynamic Range (HDR)

Used with high-contrast subjects, **High Dynamic Range (HDR)** preserves details in highlights and shadows by combining two shots taken at different exposures. HDR is most effective when used with matrix metering (□ 123; with spot or center-weighted metering and a non-CPU lens, a strength of **Auto** is equivalent to **Normal**). It can not be used to record NEF (RAW) images. Flash lighting, bracketing (□ 209), multiple exposure (□ 256), and time lapse (□ 259) can not be used while HDR is in effect and shutter speeds of $\frac{1}{200}$ and $\frac{1}{400}$ are not available.



First exposure (darker)



Second exposure (brighter)



Combined HDR image

- Select HDR (high dynamic range).** Highlight **HDR (high dynamic range)** in the photo shooting menu and press \odot .

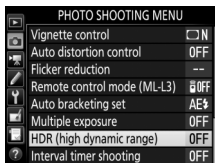

2 Select a mode.

Highlight **HDR mode** and press .

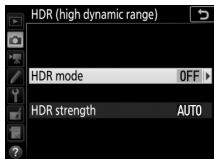

Highlight one of the following and press .

- **To take a series of HDR photographs**, select **ON  On (series)**. HDR shooting will continue until you select **Off** for **HDR mode**.
- **To take one HDR photograph**, select **On (single photo)**. Normal shooting will resume automatically after you have created a single HDR photograph.
- **To exit without creating additional HDR photographs**, select **Off**.

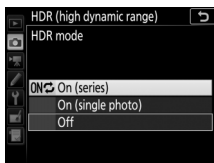

If **On (series)** or **On (single photo)** is selected, an **HDR** icon will be displayed in the viewfinder.



3 Choose the HDR strength.

To choose the difference in exposure between the two shots (HDR strength), highlight **HDR strength** and press .

Highlight the desired option and press . If **Auto** is selected, the camera will automatically adjust HDR strength to suit the scene.



4 Frame a photograph, focus, and shoot.

The camera takes two exposures when the shutter-release button is pressed all the way down. **Job Hdr** will flash in the control panel and **Job HDR** in the viewfinder while the images are combined; no photographs can be taken until recording is complete. Regardless of the option currently selected for release mode, only one photograph will be taken each time the shutter-release button is pressed.

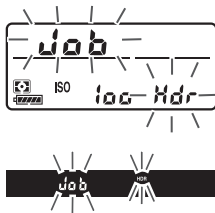

If **On (series)** is selected, HDR will only turn off when **Off** is selected for **HDR mode**; if **On (single photo)** is selected, HDR turns off automatically after the photograph is taken. The **HDR** icon clears from the display when HDR shooting ends.

Framing HDR Photographs

The edges of the image will be cropped out. The desired results may not be achieved if the camera or subject moves during shooting. Use of a tripod is recommended. Depending on the scene, the effect may not be visible, shadows may appear around bright objects, or halos may appear around dark objects. Uneven shading may be visible with some subjects.

The BKT Button

If **HDR (high dynamic range)** is selected for Custom Setting f1 (**Custom control assignment**) > **BKT button** +  (□ 266), you can select the HDR mode by pressing the **BKT** button and rotating the main command dial and the strength by pressing the **BKT** button and rotating the sub-command dial. The mode and strength are shown in the control panel: the icons representing the mode are **OFF** for **Off**, **i** for

On (single photo), and **Σ** for **On (series)**, while those representing strength are **A** for **Auto**, **HP** for **Extra high**, **H** for **High**, **n** for **Normal**, and **L** for **Low**.



Interval Timer Photography

If **On (series)** is selected for **HDR mode** before interval timer shooting begins, the camera will continue to shoot HDR photographs at the selected interval (if **On (single photo)** is selected, interval timer shooting will end after a single shot).

2 Take pictures.

The flash will pop up as required when the shutter-release button is pressed halfway and fire when a photograph is taken. *If the flash does not pop up*

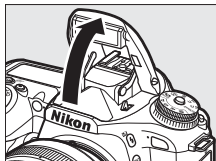

automatically, DO NOT attempt to raise it by hand. Failure to observe this precaution could damage the flash.

Flash Modes

The following flash modes are available:



Auto flash: When lighting is poor or the subject is backlit, the flash pops up automatically when the shutter-release button is pressed halfway and fires as required. Not available in  mode.



Auto with red-eye reduction: Use for portraits. The flash pops up and fires as required, but before it fires the red-eye reduction lamp lights to help reduce "red-eye." Not available in  mode.



Auto slow sync with red-eye reduction: As for auto with red-eye reduction, except that slow shutter speeds are used to capture background lighting. Use for portraits taken at night or under low light. Available in  mode.



Auto slow sync: Slow shutter speeds are used to capture background lighting in shots taken at night or under low light. Available in  mode.



Off: The flash does not fire.

Manual Pop-up Modes

In P, S, A, M, and \uparrow modes, the flash must be raised manually. The flash will not fire if it is not raised.

1 Raise the flash.

Press the \downarrow (FLASH) button to raise the flash. Note that if the flash is off or an optional external flash unit is attached, the built-in flash will not pop up; proceed to Step 2.

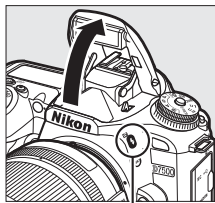

\downarrow (FLASH) button

2 Choose a flash mode (P, S, A, and M modes only).

Keeping the \downarrow (FLASH) button pressed, rotate the main command dial until the desired flash mode is displayed.

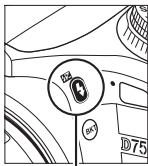

\downarrow (FLASH) button



Main command dial



3 Take pictures.

If an option other than \downarrow is selected, the flash will fire whenever a picture is taken.

Flash Modes

The following flash modes are available:



Fill flash: The flash fires with every shot.



Red-eye reduction: Use for portraits. The flash fires with every shot, but before it fires, the red-eye reduction lamp lights to help reduce “red-eye.” Not available in **¶¶** mode.



Red-eye reduction with slow sync: As for “red-eye reduction”, above, except that shutter speed slows automatically to capture background lighting at night or under low light. Use when you want to include background lighting in portraits. Not available in modes **S**, **M**, and **¶¶**.



Slow sync: As for “fill flash”, above, except that shutter speed slows automatically to capture background lighting at night or under low light. Use when you want to capture both subject and background. Not available in modes **S**, **M**, and **¶¶**.



Slow rear-curtain sync: As for “rear-curtain sync”, below, except that shutter speed slows automatically to capture background lighting at night or under low light. Use when you want to capture both subject and background. Not available in modes **S**, **M**, and **¶¶**. **SLOW** is displayed when setting is complete.

Rear-curtain sync: The flash fires just before the shutter closes, creating a stream of light behind moving light sources as shown below at right. Not available in modes **P**, **A**, and **¶¶**.



Front-curtain sync



Rear-curtain sync



Off: The flash does not fire. Not available in **¶¶** mode.

Lowering the Built-in Flash

To save power when the flash is not in use, press it gently downward until the latch clicks into place.

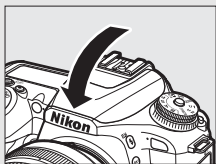

The Built-in Flash

Remove lens hoods to prevent shadows. The flash has a minimum range of approximately 0.6 m (2 ft) and can not be used in the macro range of zoom lenses with a macro function. Use lenses with focal lengths of 16 mm to 300 mm; peripheral illumination may drop if the flash is used with lenses with focal lengths under 16 mm. i-TTL flash control is available at ISO sensitivities between 100 and 12800; at values over 12800, the desired results may not be achieved at some ranges or aperture values.

If the flash fires in continuous release modes (□ 86), only one picture will be taken each time the shutter-release button is pressed.

The shutter release may be briefly disabled to protect the flash after it has been used for several consecutive shots. The flash can be used again after a short pause.

Shutter Speeds Available with the Built-in Flash

The following shutter speeds are available with the built-in flash.

Mode	Shutter speed
AUTO,	

Flash Control Mode

In **P**, **S**, **A**, and **M** modes, the flash control mode for the built-in flash can be selected using the **Flash control > Flash control mode (built-in)** option in the photo shooting menu. The options available vary with the item selected.

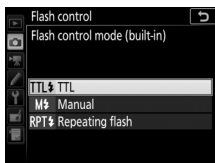

Option	Description
TTL	Flash level is adjusted automatically in response to shooting conditions.
Manual	Flash level is selected using Manual output amount .
Repeating flash	The flash fires repeatedly while the shutter is open, producing a multiple-exposure effect. Choose the flash level (Output), the maximum number of times the unit fires (Times), and the number of times the flash fires per second (Frequency , measured in Hertz). The options available for Times vary with the option selected for Output ; the number of times the flash actually fires may be less at fast shutter speeds or lower frequencies.

"Times"

The options available for **Repeating Flash > Times** are determined by flash output.

Output	Options available for "Times"	Output	Options available for "Times"
1/4	2	1/32	2–10, 15
1/8	2–5	1/64	2–10, 15, 20, 25
1/16	2–10	1/128	2–10, 15, 20, 25, 30, 35

🔍 **Flash Control for Optional Flash Units**

When an optional flash unit is connected, the **Flash control > Flash control mode (built-in)** option in the photo shooting menu changes to **Flash control mode (external)**.

🔍 **Flash Control Mode**

In i-TTL flash control, the camera sets the flash level based on light reflected from a series of nearly invisible preflashes (monitor preflashes) emitted immediately before the main flash fires. The camera supports the following i-TTL flash control modes:

- **i-TTL balanced fill-flash for digital SLR:** Preflashes reflected from objects in all areas of frame are picked up by 180K-pixel (approximately 180,000-pixel) RGB sensor and are analyzed to adjust flash output for natural balance between main subject and ambient background lighting. If type G, E, or D lens is used, distance information is included when calculating flash output. Not available when spot metering is used.
- **Standard i-TTL fill-flash for digital SLR:** Flash output adjusted to bring lighting in frame to standard level; brightness of background is not taken into account. Recommended for shots in which main subject is emphasized at expense of background details, or when exposure compensation is used. Standard i-TTL fill-flash for digital SLR is activated automatically when spot metering is selected.

Aperture, Sensitivity, and Flash Range

Flash range varies with sensitivity (ISO equivalency) and aperture.

Aperture at ISO equivalent of								Approximate range	
100	200	400	800	1600	3200	6400	12800	m	ft
1.4	2	2.8	4	5.6	8	11	16	0.7–8.5	2ft 4in.–27ft 10in.
2	2.8	4	5.6	8	11	16	22	0.6–6.0	2ft–19ft 8in.
2.8	4	5.6	8	11	16	22	32	0.6–4.2	2ft–13ft 9in.
4	5.6	8	11	16	22	32	—	0.6–3.0	2ft–9ft 10in.
5.6	8	11	16	22	32	—	—	0.6–2.1	2ft–6ft 10in.
8	11	16	22	32	—	—	—	0.6–1.5	2ft–4ft 11in.
11	16	22	32	—	—	—	—	0.6–1.1	2ft–3ft 7in.
16	22	32	—	—	—	—	—	0.6–0.8	2ft–2ft 7in.



In mode **P**, the maximum aperture (minimum f-number) is limited according to ISO sensitivity, as shown below:

Maximum aperture at ISO equivalent of:							
100	200	400	800	1600	3200	6400	12800
2.8	3.5	4	5	5.6	7.1	8	10

If the maximum aperture of the lens is smaller than given above, the maximum value for aperture will be the maximum aperture of the lens.

See Also

For information on:

- Locking flash value for a metered subject before recomposing a photograph, see “FV Lock” (□ 169).
- Enabling or disabling auto FP high-speed sync and choosing a flash sync speed, see  > Custom Setting e1 (**Flash sync speed**, □ 265).
- Choosing the slowest shutter speed available when using the flash, see  > Custom Setting e2 (**Flash shutter speed**, □ 265).

Flash Compensation (P, S, A, M, and SCENE Modes Only)

Flash compensation is used to alter flash output by from -3 EV to $+1$ EV in increments of $\frac{1}{3}$ EV, changing the brightness of the main subject relative to the background. Flash output can be increased to make the main subject appear brighter, or reduced to prevent unwanted highlights or reflections.

Press the  button and rotate the sub-command dial until the desired value is displayed. In general, choose positive values to make the main subject brighter, negative values to make it darker.

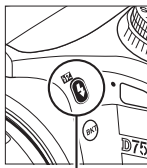

 button

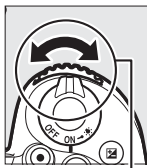

Sub-command dial



± 0 EV

 button pressed)





-0.3 ($-\frac{1}{3}$) EV



$+1.0$ EV

Live View



In live view, the selected value is displayed in the monitor while flash compensation is being adjusted.

At values other than ± 0.0 , a  icon will be displayed after you release the  button. The current value for flash compensation can be confirmed by pressing the  button.

Normal flash output can be restored by setting flash compensation to ± 0.0 . Except in **SCENE** mode, flash compensation is not reset when the camera is turned off (in **SCENE** mode, flash compensation will be reset when another mode is selected or the camera is turned off).

See Also

For information on:

- Choosing the size of the increments available for flash compensation, see  > Custom Setting b2 (**EV steps for exposure ctrl**, [□ 262](#)).
- Choosing whether flash compensation is applied in addition to exposure compensation when the flash is used, see  > Custom Setting e3 (**Exposure comp. for flash**, [□ 265](#)).
- Automatically varying flash level over a series of shots, see “Bracketing” ([□ 209](#)).

FV Lock

This feature is used to lock flash output, allowing photographs to be recomposed without changing the flash level and ensuring that flash output is appropriate to the subject even when the subject is not positioned in the center of the frame. Flash output is adjusted automatically for any changes in ISO sensitivity and aperture.

To use FV lock:

1 Assign FV lock to a camera control.

Assign **FV lock** to a control using Custom Setting f1 (**Custom control assignment**,  266).

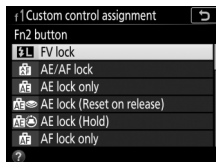





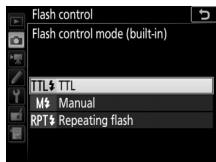





2 Select TTL flash control.



Select **TTL** for **Flash control** > **Flash control mode (built-in)** in the photo shooting menu.

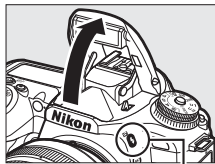

3 Raise the flash.

In **P**, **S**, **A**, **M**, and **Hi** modes, the flash can be raised by pressing the  () button. In , , , , , , **VI**, **POP**, , and  modes, the flash will pop up automatically when required.



 () button

4 Focus.

Position the subject in the center of the frame and press the shutter-release button halfway to focus.



5 Lock flash level.

After confirming that the flash-ready indicator (⚡) is displayed, press the control selected in Step 1. The flash will emit a monitor preflash to determine the appropriate flash level. Flash output will be locked at this level and an FV lock icon (FV) will appear in the display.



6 Recompose the photograph.



7 Take the photograph.

Press the shutter-release button the rest of the way down to shoot. If desired, additional pictures can be taken without releasing FV lock.

8 Release FV lock.

Press the control selected in Step 1 to release FV lock. Confirm that the FV lock icon (FV) is no longer displayed.

Metering

When the built-in flash is used without an external flash unit, the metering area for FV lock is confined to a 4-mm circle in the center of the frame. When the built-in flash is used as a master flash controlling remote flash units, the camera meters the entire frame.

Viewing Information for the Built-in Flash

In modes **P**, **S**, **A**, and **M**, you can press the **Info** button to view flash info in the information display (📖 201) when the built-in flash is raised. The information displayed varies with the flash control mode.

■ TTL

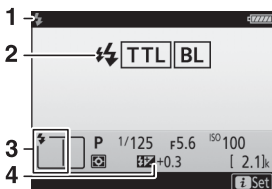

- 1 Flash-ready indicator55
- 2 Flash control mode 164
- 3 Flash mode162
- 4 Flash compensation 167

■ Manual (📖 164)

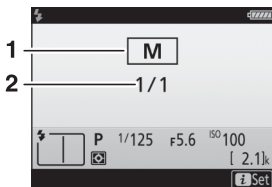

- 1 Flash control mode
- 2 Flash level

■ Repeating Flash (📖 164)

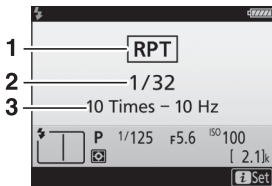

- 1 Flash control mode
- 2 Flash level
- 3 Number emitted (times)
Frequency

Flash Info and Camera Settings



The flash information display shows selected camera settings, including shooting mode, shutter speed, aperture, and ISO sensitivity.



Flash Control Mode

The information display shows the flash control mode as follows:



i-TTL	 A flash icon with a lightning bolt and a battery level indicator. To the right, a box contains 'TTL'.
Manual	 A flash icon with a lightning bolt and a battery level indicator. To the right, a box contains 'M'.
Repeating flash	 A flash icon with a lightning bolt and a battery level indicator. To the right, a box contains 'RPT'.

Optional Flash Units

You can:

- **Mount an optional flash unit on the accessory shoe**
(see the manual provided with the flash unit)



- **Control remote flash units with optical signals from the built-in flash** (see the *Menu Guide*)

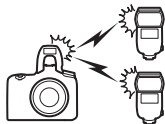

- **Control remote flash units with optical signals from an optional flash unit mounted on the accessory shoe**
(see the *Menu Guide*)

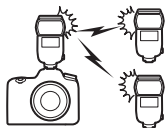

- **Mount an SB-5000 on the accessory shoe to control remote flash units with radio signals transmitted via a WR-R10, using settings chosen with the SB-5000** (see the *Menu Guide*)

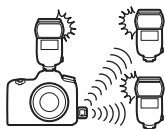

- **Control remote flash units with optical signals from the built-in flash and radio signals transmitted via a WR-R10** (see the *Menu Guide*)

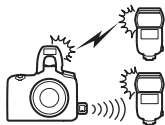

- **Control remote flash units with radio signals transmitted via a WR-R10** (see the *Menu Guide*)



Remote Control Photography

Using an Optional ML-L3 Remote Control

The optional ML-L3 remote control (☞ 287) can be used to reduce camera shake or for self-portraits.



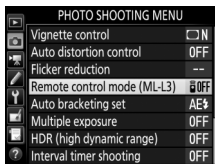

1 Select Remote control mode (ML-L3).

Highlight **Remote control mode (ML-L3)** in the photo shooting menu and press .



2 Choose a remote control mode.

Highlight one of the following options and press .

Option	Description
 2s Delayed remote	Shutter is released 2 s after ML-L3 shutter-release button is pressed.
 Quick-response remote	Shutter is released when ML-L3 shutter-release button is pressed.
 Remote mirror-up	Press ML-L3 shutter-release button once to raise mirror, again to release shutter and take photograph. Prevents blur caused by camera moving when mirror is raised.
 Off	The shutter can not be released using the ML-L3.

3 Frame the photograph.

Mount the camera on a tripod or place the camera on a stable, level surface.

4 Take the photograph.

From a distance of 5 m (16 ft) or less, aim the transmitter on the ML-L3 at the infrared receiver on the camera and press the ML-L3 shutter-release button. *In delayed remote mode*, the self-timer lamp will light for about two seconds before the shutter is released.

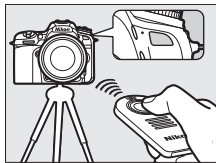

In quick-response remote mode, the self-timer lamp will flash after the shutter has been released. *In remote mirror-up mode*, pressing the ML-L3 shutter-release button once raises the mirror; the shutter will be released and the self-timer lamp will flash after 30 s or when the button is pressed a second time.



Release Mode

Pictures taken with an optional ML-L3 remote control are shot in single-frame advance mode, regardless of the option selected with the release mode dial.

Before Using Optional ML-L3 Remote Controls

Before using the remote control for the first time, remove the clear plastic battery-insulator sheet.

Using the Built-in Flash

Before taking a photograph with the flash in manual pop-up modes (☐ 161), press the  (🔋) button to raise the flash and wait for the flash-ready indicator () to be displayed (☐ 55). Shooting will be interrupted if the flash is raised while remote control mode is in effect. If the flash is required, the camera will only respond to the ML-L3 shutter-release button once the flash has charged. In auto pop-up modes (☐ 159), the flash will begin charging when remote control mode is selected; once the flash is charged, it will automatically pop up and fire when required.

In flash modes that support red-eye reduction, the red-eye reduction lamp will light for about one second before the shutter is released. In delayed remote mode, the self-timer lamp will light for two seconds, followed by the red-eye reduction lamp which lights for one second before the shutter is released.



Focusing in Remote Control Mode

The camera will not adjust focus continuously when continuous-servo autofocus is selected; note however that regardless of the autofocus mode selected, you can focus by pressing the camera shutter-release button halfway before shooting. If auto- or single-servo autofocus is selected or the camera is in live view in delayed or quick-response remote mode, the camera will automatically adjust focus before shooting; if the camera is unable to focus in viewfinder photography, it will return to stand-by without releasing the shutter.

Remote Mirror-up Mode

While the mirror is raised, photos can not be framed in the viewfinder and autofocus and metering will not be performed.

Exiting Remote Control Mode

Remote control is cancelled automatically if no photograph is taken before the time selected for Custom Setting c5 (**Remote on duration (ML-L3)**,  263), **Off** is selected for **Remote control mode (ML-L3)**, a two-button reset is performed ( 206), or shooting options are reset using **Reset photo shooting menu** ( 252).

Assign Shutter Button





If **Record movies** is selected for Custom Setting g1 (**Custom control assignment**) > **Shutter-release button**, the ML-L3 can not be used when the live view selector is rotated to .

Cover the Viewfinder

To prevent light entering via the viewfinder from appearing in photographs or interfering with exposure, remove the rubber eyecup and cover the viewfinder with the supplied eyepiece cap ( 90).

See Also

For information on:

- Choosing the length of time the camera will remain in stand-by mode waiting for a signal from the remote control, see  > Custom Setting c5 (**Remote on duration (ML-L3)**;  263).
- The beep that sounds when the remote control is used, see  > **Beep options** ( 271).

Recording and Viewing Movies

Recording Movies

Movies can be recorded in live view.

- 1 Rotate the live view selector to  (movie live view).

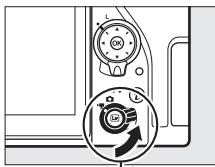

Live view selector

- 2 Press the  button.

The mirror will be raised and the view through the lens will be displayed in the camera monitor, modified for the effects of exposure. The subject will no longer be visible in the viewfinder.

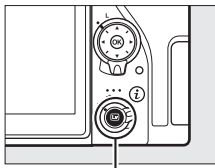

 button

The Icon

A  icon ([185](#)) indicates that movies can not be recorded.

White Balance

In modes **P**, **S**, **A**, and **M**, white balance can be set at any time by pressing the  (**WB**) button and rotating the main command dial ([130](#)).

3 Focus.

Frame the opening shot and press the shutter-release button halfway to focus; to zoom in for precise focus as describe in “Live View Zoom Preview” (□ 57), press the  (QUAL) button. Note that the number of subjects that can be detected in face-priority AF drops during movie recording.



Exposure

The following exposure settings can be adjusted in movie mode:

	Aperture	Shutter speed	ISO sensitivity
P, S ¹	—	—	— ^{2,3}
A	✓	—	— ^{2,3}
M	✓	✓	✓ ^{3,4}
Other shooting modes	—	—	—

- 1 Exposure for mode **S** is equivalent to mode **P**.
- 2 The upper limit for ISO sensitivity can be selected using the **ISO sensitivity settings > Maximum sensitivity** option in the movie shooting menu (□ 257).
- 3 Regardless of the option chosen for **ISO sensitivity settings > Maximum sensitivity** or for **ISO sensitivity (mode M)**, the upper limit when **On** is selected for **Electronic VR** in the movie shooting menu is ISO 51200.
- 4 If **On** is selected for **ISO sensitivity settings > Auto ISO control (mode M)** in the movie shooting menu, the upper limit for ISO sensitivity can be selected using the **Maximum sensitivity** option.

In mode **M**, shutter speed can be set to values between $\frac{1}{25}$ s and $\frac{1}{8000}$ s (the slowest available shutter speed varies with the frame rate; □ 188). In other modes, shutter speed is adjusted automatically. If the subject is over- or under-exposed in modes other than **A** or **M**, end live view and start live view again or select mode **A** and adjust aperture.

4 Start recording.

Press the movie-record button to start recording. A recording indicator and the time available are displayed in the monitor. Exposure can be locked by pressing the AE-L/AF-L button (125) or altered by up to ± 3 EV in steps of $\frac{1}{3}$ EV using exposure compensation (127); spot metering is not available. In autofocus mode, the camera can be refocused by pressing the shutter-release button halfway or by tapping your subject in the monitor.

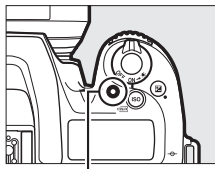

Movie-record button

Recording indicator



Time remaining

Audio

The camera can record both video and sound; do not cover the microphone on the front of the camera during movie recording. Note that the built-in microphone may record sounds made by the camera or lens during autofocus, vibration reduction, or changes to aperture.

5 End recording.

Press the movie-record button again to end recording. Recording will end automatically when the maximum length is reached, or the memory card is full (note that depending on memory card write speed, shooting may end before the maximum length is reached).

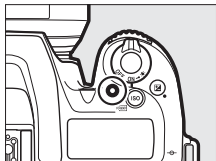

6 Exit live view.

Press the **[Lv]** button to exit live view.

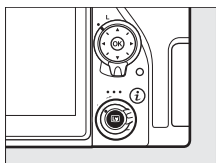



See Also

For information on:

- Choosing how the camera focuses in movie mode, see “Autofocus” (📖 100).
- Focusing using the lens focus ring, see “Manual Focus” (📖 115).





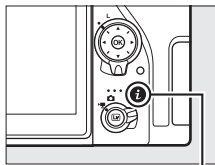



Using the *i* Button

The options listed below can be accessed by pressing the *i* button in movie mode. Use the touch screen or navigate the menu using the multi selector and  button, using the multi selector to highlight items, pressing  to view options, and pressing  to select the highlighted option and return to the *i*-button menu. Press the *i* button again to exit to the shooting display.







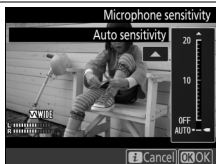

i button



Option	Description
Choose image area	Choose image area for movies ( 190).
Frame size/frame rate	Select a frame size and rate ( 188).
Movie quality	Choose movie quality ( 188).
Active D-Lighting	Adjust Active D-Lighting ( 153). Not available at a frame size of 3840 × 2160 ( 188).
Microphone sensitivity	Press  or  to adjust microphone sensitivity. Both the built-in and external microphones ( 287) are affected.
Frequency response	Control the frequency response of the built-in or external microphones.
Wind noise reduction	Enable or disable wind noise reduction using the built-in microphone's low-cut filter.

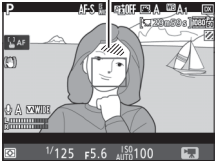

Option	Description
Set Picture Control	Choose Picture Control used for movies (□ 148).
Monitor brightness	Press  or  to adjust monitor brightness (note that this affects live view only and has no effect on photographs or movies or on the brightness of the monitor for menus or playback; □ 269).
Multi-selector power aperture	Select Enable to enable power aperture. Press  to widen the aperture,  to narrow the aperture.
Highlight display	<p>Choose whether the brightest areas of the frame (highlights) are shown by slanting lines in the display.</p> <div data-bbox="640 346 919 599" style="text-align: center;"> <p><i>Highlights</i></p>  </div>
Headphone volume	Press  or  to adjust headphone volume.
Electronic VR	Select On to enable electronic vibration reduction in movie mode. Not available at a frame size of 3840 × 2160 (□ 188). Note that if the electronic vibration reduction is on and DX is selected for Choose image area , the angle of view is reduced and the edges of the frame will be cropped out.

Using an External Microphone

The optional ME-1 stereo microphone or ME-W1 wireless microphone can be used to record sound for movies (□ 287).

Headphones

Third-party headphones can be used. Note that high sound levels may result in high volume; particular care should be taken when headphones are used.

The Live View Display: Movies

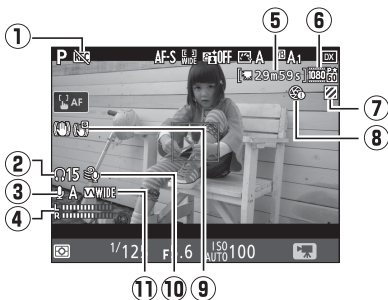



Item	Description
① "No movie" icon	Indicates that movies can not be recorded.
② Headphone volume	Volume of audio output to headphones. Displayed when third-party headphones are connected (☞ 184).
③ Microphone sensitivity	Microphone sensitivity (☞ 183).
④ Sound level	Sound level for audio recording. Displayed in red if level is too high; adjust microphone sensitivity accordingly.
⑤ Time remaining	The recording time available for movies.
⑥ Movie frame size	The frame size for movie recording (☞ 188).
⑦ Highlight display indicator	Displayed when highlight display is on (☞ 184).
⑧ "No power aperture" indicator	Indicates that power aperture is unavailable (☞ 184).
⑨ Electronic VR indicator	Displayed when electronic vibration reduction is on (☞ 184).
⑩ Wind noise reduction	Displayed when wind noise reduction is on (☞ 183).
⑪ Frequency response	The current frequency response (☞ 183).

✔ The Count Down Display

A count down will be displayed 30 s before live view ends automatically (the timer turns red if live view is about to end to protect the internal circuits or, if an option other than **No limit** is selected for Custom Setting c4—**Monitor off delay** > **Live view**; □ 263—5 s before the monitor is due to turn off automatically). Depending on shooting conditions, the timer may appear immediately when live view is selected. Movie recording will end automatically when the timer expires, regardless of the amount of recording time available.

✎ Adjusting Settings During Movie Recording

Headphone volume can not be adjusted during recording. If an option other than  (microphone off) is currently selected, microphone sensitivity can be changed to any setting other than  while recording is in progress.





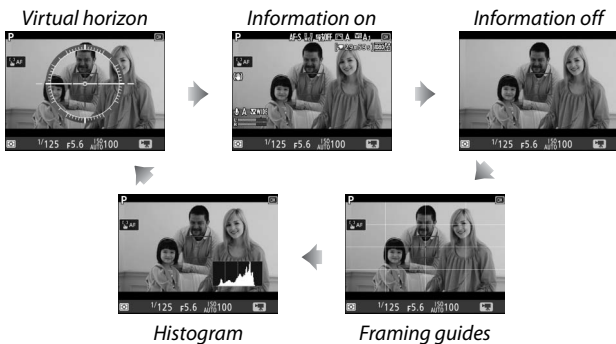





Viewing and Hiding Indicators

To hide or display indicators in the monitor, press the **info** button.



Frame Size, Frame Rate, and Movie Quality

The **Frame size/frame rate** option in the movie shooting menu is used to choose the movie frame size (in pixels) and frame rate. You can also choose from two **Movie quality** options: high and normal. Together, these options determine the maximum bit rate, as shown in the following table.

Option ¹	Maximum bit rate (Mbps) (★ high quality/Normal)	Maximum length
 3840 × 2160 (4K UHD); 30p ²	144	29 min. 59 s ³
 3840 × 2160 (4K UHD); 25p ²		
 3840 × 2160 (4K UHD); 24p ²		
 1920 × 1080; 60p	48/24	
 1920 × 1080; 50p		
 1920 × 1080; 30p	24/12	
 1920 × 1080; 25p		
 1920 × 1080; 24p		
 1280 × 720; 60p		
 1280 × 720; 50p		

- Actual frame rate is 29.97 fps for values listed as 30p, 23.976 fps for values listed as 24p, and 59.94 fps for values listed as 60p.
- When this option is selected,  is displayed in the monitor and movie quality is fixed at "high".
- Each movie will be recorded across up to 8 files of up to 4 GB each. The number of files and the length of each file vary with the options selected for **Frame size/frame rate** and **Movie quality**.

Indices





If **Index marking** is assigned to a control using Custom Setting g1 (**Custom control assignment**, □ 267), you can press the selected control during recording to add indices that can be used to locate frames during editing and playback (□ 195; note that indices can not be added in  mode). Up to 20 indices can be added to each movie.



Index

See Also

For information on:

- Frame size, frame rate, microphone sensitivity, and ISO sensitivity, see “The Movie Shooting Menu: Movie Shooting Options” (□ 257).
- Choosing the role played by the  button, see  > Custom Setting f2 (**OK button**; □ 266).
- Choosing the roles of the **Fn1**, **Fn2**, and  **AE-L/AF-L** buttons, see  > Custom Setting g1 (**Custom control assignment**; □ 267).
- Choosing whether the shutter-release button can be used to start live view or to start and end movie recording, see  > Custom Setting g1 (**Custom control assignment**) > **Shutter-release button** (□ 267).

The Movie Crop

Movies have an aspect ratio of 16 : 9 and are recorded using a crop that varies with the frame size and the option selected for **Choose image area** in the movie shooting menu (📖 188, 257).

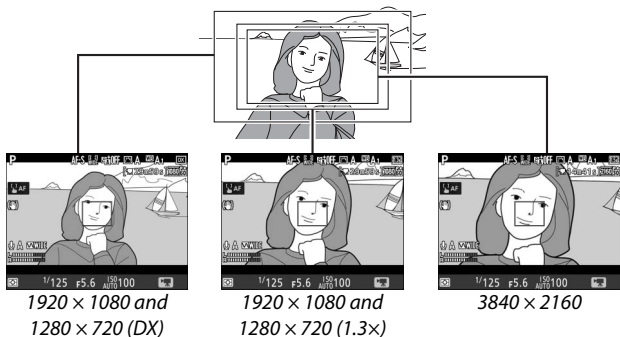

Movie crop sizes are given below:



- At a frame size of 3840×2160 , the movie crop is approximately 16.2×9.1 mm, regardless of the option selected for **Choose image area**. The apparent focal length is approximately $1.5\times$ greater than that for DX format.
- With **DX** selected for **Choose image area** and a frame size of 1920×1080 or 1280×720 , the movie crop is approximately 23.5×13.3 mm.
- With **1.3x** selected for **Choose image area** and a frame size of 1920×1080 or 1280×720 , the movie crop is approximately 18.0×10.1 mm. The apparent focal length is approximately $1.3\times$ greater than that for DX format.

Taking Photos in Movie Mode

To take photos in movie mode (either in live view or during movie recording), select **Take photos** for Custom Setting g1 (**Custom control assignment**) >



Shutter-release button (☞ 267). Photos with an aspect ratio of 16 : 9 can then be taken at any time by pressing the shutter-release button all the way down. If movie recording is in progress, recording will end and the footage recorded to that point will be saved.

Except at a frame size of 3840 × 2160 (☞ 188), photographs are recorded in the format selected for **Image quality** in the photo shooting menu (☞ 97); photos taken at a frame size of 3840 × 2160 are recorded at an image quality of JPEG fine★. For information on image size, see “Image Size” (☞ 192). Note that the exposure for photographs can not be previewed when the live view selector is rotated to ; accurate results can be achieved in mode **M** by previewing exposure with the live view selector rotated to .

■ Image Size

The size of photos taken in movie mode varies with the movie frame size (☞ 188) and, in the case of photos taken at frame sizes of 1920 × 1080 and 1280 × 720, with the image area and the option selected for **Image size** in the photo shooting menu (☞ 99).

Frame size	Image area	Image size	Size (pixels)
3840 × 2160	—		3840 × 2160
1920 × 1080 1280 × 720	DX	Large	5568 × 3128
		Medium	4176 × 2344
		Small	2784 × 1560
	1.3×	Large	4272 × 2400
		Medium	3200 × 1800
		Small	2128 × 1192

✍ HDMI

If the camera is connected to an HDMI device, the view through the lens will appear both in the camera monitor and on the HDMI device.

✍ Wireless Remote Controllers and Remote Cords

If **Record movies** is selected for Custom Setting g1 (**Custom control assignment**) > **Shutter-release button** (☞ 267), the shutter-release buttons on optional wireless remote controllers and remote cords (☞ 287) can be pressed halfway to start live view or pressed all the way down to start and end movie recording.

✓ Recording Movies

Movies are recorded in the sRGB color space. Flicker, banding, or distortion may be visible in the monitor and in the final movie under fluorescent, mercury vapor, or sodium lamps or with subjects that are in motion, particularly if the camera is panned horizontally or an object moves horizontally at high speed through frame (for information on reducing flicker and banding, see **Flicker reduction**, □ 259). Flicker may also appear while power aperture is in use. Jagged edges, color fringing, moiré, and bright spots may also appear. Bright regions or bands may appear in some areas of the frame with flashing signs and other intermittent light sources or if the subject is briefly illuminated by a strobe or other bright, momentary light source. Avoid pointing the camera at the sun or other strong light sources. Failure to observe this precaution could result in damage to the camera's internal circuitry. Note that noise (randomly-spaced bright pixels, fog, or lines) and unexpected colors may appear if you zoom in on the view through the lens (□ 57) in movie mode.

Flash lighting can not be used.

Recording ends automatically if the lens is removed or the mode dial or the live view selector is rotated to a new setting.

Using live view for extended periods may cause the grip and areas of the camera around the monitor to become hot. This does not indicate a malfunction.

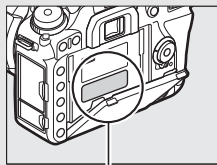



This area becomes particularly hot.

⚡ Beeps During Live View





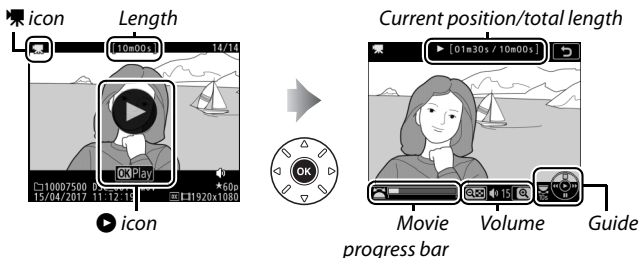

A beep may sound if you adjust aperture, use the live view selector, or rotate the mode dial during live view. This does not indicate an error or malfunction.

Viewing Movies

Movies are indicated by a  icon in full-frame playback (225). Tap the  icon in the monitor or press  to start playback; your current position is indicated by the movie progress bar.



The following operations can be performed:

To	Description
Pause	Press  to pause playback.
Play	Press  to resume playback when the movie is paused or during rewind/advance.
Rewind/advance	Press  to rewind,  to advance. Speed increases with each press, from 2x to 4x to 8x to 16x; keep the control pressed to skip to the beginning or end of the movie (the first frame is indicated by a  in top right corner of monitor, the last frame by a ). If playback is paused, the movie rewinds or advances one frame at a time; keep the control pressed for continuous rewind or advance.
Start slow-motion playback	Press  while the movie is paused to start slow-motion playback.

To	Description
Skip 10 s	Rotate the main command dial one stop to skip ahead or back 10 s.
Skip ahead/back	Rotate the sub-command dial to skip to the next or previous index, or to skip to the last or first frame if the movie contains no indices.
Adjust volume	Press QUAL to increase volume, QUAL (🔊) to decrease.
Trim movie	Press the i button to view movie editing options (📖 196).
Exit	Press ⏪ or ⏩ to exit to full-frame playback.
Return to shooting mode	Press the shutter-release button halfway to exit to shooting mode.



The Icon

Movies with indices (📖 189) are indicated by a  icon in full-frame playback.



Editing Movies

Trim footage to create edited copies of movies or save selected frames as JPEG stills.

Option	Description
 Choose start/end point	Create a copy from which unwanted footage has been removed.
 Save selected frame	Save a selected frame as a JPEG still.





Trimming Movies



To create trimmed copies of movies:

1 Display a movie full frame (📖 225).

2 Pause the movie on the new opening frame.

Play the movie back as described in “Viewing Movies” (📖 194), pressing  to start and resume playback and  to pause and pressing  or  or rotating the main or sub-command dial to locate the desired frame. Your approximate position in the movie can be ascertained from the movie progress bar. Pause playback when you reach the new opening frame.



Movie progress bar

3 Select **Choose start/end point**.

Press the **i** button, then highlight **Choose start/end point** and press **OK**.



4 Select **Start point**.

To create a copy that begins from the current frame, highlight **Start point** and press **OK**. The frames before the current frame will be removed when you save the copy in Step 9.

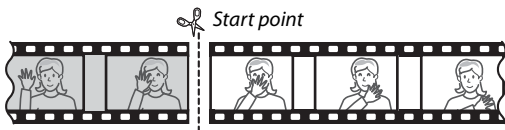
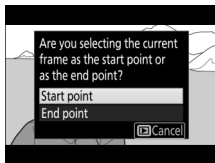

5 Confirm the new start point.

If the desired frame is not currently displayed, press **◀** or **▶** to advance or rewind (to skip to 10 s ahead or back, rotate the main command dial one stop; to skip to an index, or to the first or last frame if the movie contains no indices, rotate the sub-command dial).



6 Choose the end point.

Press **WB** to switch from the start point (▣) to the end point (▣) selection tool and then select the closing frame as described in Step 5. The frames after the selected frame will be removed when you save the copy in Step 9.

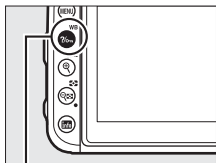

WB button

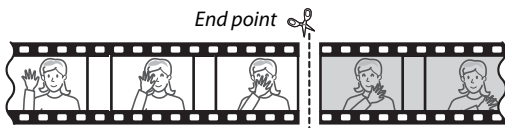

7 Create the copy.

Once the desired closing frame is displayed, press **⏏**.

8 Preview the movie.

To preview the copy, highlight **Preview** and press **OK** (to interrupt the preview and return to the save options menu, press **⏏**). To abandon the current copy and select a new start point or end point as described above, highlight **Cancel** and press **OK**; to save the copy, proceed to Step 9.

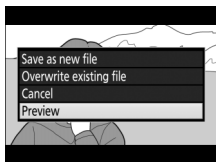

9 Save the copy.

Highlight **Save as new file** and press **OK** to save the copy to a new file. To replace the original movie file with the edited copy, highlight **Overwrite existing file** and press **OK**.

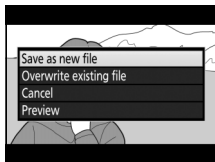

✍ Trimming Movies

Movies must be at least two seconds long. The copy will not be saved if there is insufficient space available on the memory card.

Copies have the same time and date of creation as the original.

✍ Removing Opening or Closing Footage

To remove only the opening footage from the movie, proceed to Step 7 without pressing the **W/B** button in Step 6. To remove only the closing footage, select **End point** in Step 4, select the closing frame, and proceed to Step 7 without pressing the **W/B** button in Step 6.

✍ The Retouch Menu

Movies can also be edited using the **Edit movie** option in the retouch menu (☞ 277).

Saving Selected Frames

To save a copy of a selected frame as a JPEG still:

1 Pause the movie on the desired frame.

Play the movie back as described in “Viewing Movies” (📖 194), pressing **OK** to start and resume playback and **⏸** to pause. Pause the movie at the frame you intend to copy.



2 Choose **Save selected frame**.

Press the **i** button, then highlight **Save selected frame** and press **OK** to create a JPEG copy of the current frame (📖 97).

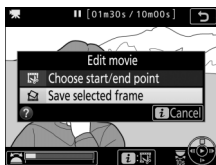

Save Selected Frame

JPEG movie stills created with the **Save selected frame** option can not be retouched. JPEG movie stills lack some categories of photo information (📖 231).

Other Shooting Options

The **info** Button (Viewfinder Photography)

During viewfinder photography, you can press the **info** button to view an information display in the monitor listing such data as shutter speed, aperture, number of exposures remaining, and AF-area mode.

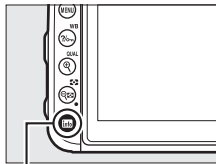

info button

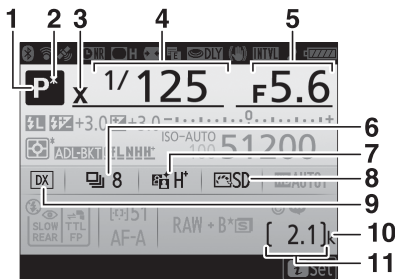

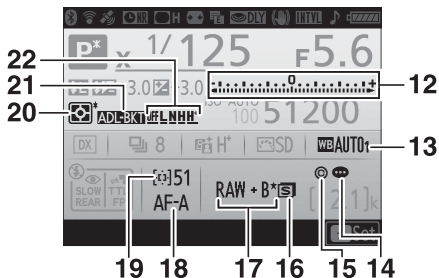

- | | |
|---|--|
| 1 Shooting mode6 | 9 Image area indicator..... 93 |
| 2 Flexible program indicator 73 | 10 "k" (appears when memory remains for over 1000 exposures)..... 47 |
| 3 Flash sync indicator265 | 11 Number of exposures remaining 47 |
| 4 Shutter speed74, 76 | Time-lapse recording indicator 259 |
| 5 Aperture (f-number)75, 76 | |
| 6 Release mode 86 | |
| Continuous shooting speed..... 86 | |
| 7 Active D-Lighting indicator 153 | |
| 8 Picture Control indicator 148 | |



12	Exposure indicator77	17	Image quality97
	Exposure compensation display 127	18	Autofocus mode 100
	Bracketing progress indicator	19	AF-area mode indicator 103
	Exposure and flash bracketing..... 210	20	Metering..... 123
	WB bracketing.....215	21	Exposure and flash bracketing indicator 210
13	White balance 130		WB bracketing indicator 215
	White balance fine-tuning indicator 134		ADL bracketing indicator 219
14	Image comment indicator 270		HDR indicator 155
15	Copyright information 271	22	ADL bracketing amount 219
16	Image size.....99		HDR strength..... 156
			Multiple exposure indicator 256

Turning the Monitor Off

To clear shooting or flash information from the monitor, press the  button again or press the shutter-release button halfway. The monitor will turn off automatically if no operations are performed for about 4 seconds. The monitor will also turn off if you cover the eye sensor or look through the viewfinder. For information on choosing how long the monitor remains on before turning off automatically, see Custom Setting c4 (**Monitor off delay**,  263).

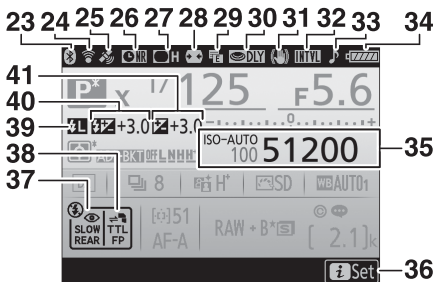

23	Bluetooth connection indicator 273	33	“Beep” indicator 271
	Airplane mode 272	34	Battery indicator 46
24	Wi-Fi connection indicator 272, 273	35	ISO sensitivity indicator 118
	Eye-Fi connection indicator 273		ISO sensitivity 118
25	Satellite signal indicator 224		Auto ISO sensitivity indicator 120
26	Long exposure noise reduction indicator 255	36	i icon 205
27	Vignette control indicator 255	37	Flash mode 159, 161
28	Auto distortion control 255	38	Flash control indicator 164
29	Electronic front-curtain shutter 264	39	FV lock indicator 169
30	Exposure delay mode 264	40	Flash compensation indicator 167
31	Vibration reduction indicator 265		Flash compensation value 167
32	Interval timer indicator 256	41	Exposure compensation indicator 127
	Time-lapse indicator 259		Exposure compensation value 127
	“Clock not set” indicator 204		

Note: Display shown with all indicators lit for illustrative purposes.

See Also

For information on changing the color of the lettering in the information display, see **Y > Information display** (□ 269).

The ☹ (“Clock Not Set”) Icon

The camera clock is powered by an independent, rechargeable power source, which is charged as necessary when the main battery is installed or the camera is powered by an optional power connector and AC adapter (□ 287). Two days of charging will power the clock for about three months. If a ☹ icon flashes in the information display, the clock has been reset and the date and time recorded with new photographs will not be correct. Use the **Time zone and date > Date and time** option in the setup menu to set the clock to the correct time and date (□ 268).

The *i* Button

To access the options below, press the *i* button during viewfinder and live view photography. Use the touch screen or navigate the menu using the multi-selector and OK button, using the multi-selector to highlight items and pressing OK to view options. To return to shooting mode, press the shutter-release button halfway.

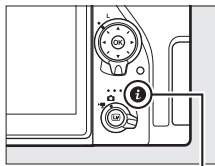

i button

■ Viewfinder Photography

Option	
Custom control assignment	266
Choose image area	93
Set Picture Control	148
Active D-Lighting	153
Long exposure NR	255
High ISO NR	255
Remote control mode (ML-L3)	175





■ Live View Photography

Option	
Choose image area	93
Image quality	97
Image size	99
Set Picture Control	148
Active D-Lighting	153
Remote control mode (ML-L3)	175
Electronic front-curtain shutter	264
Exposure preview	78
Monitor brightness	269



Two-Button Reset: Restoring Default Settings

The camera settings listed below can be restored to default values by holding the  () and  buttons down together for more than two seconds (these buttons are marked by a green dot). The control panel turns off briefly while settings are reset.

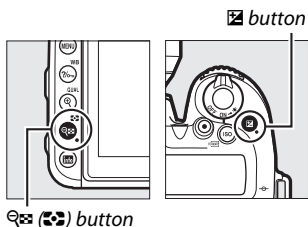

■ Settings Accessible from the Photo Shooting Menu









Option	Default
Image quality	JPEG normal
Image size	Large
ISO sensitivity settings	
ISO sensitivity	
P, S, A, M	100
Other modes	Auto
Auto ISO sensitivity control	Off
White balance	Auto > Normal
Fine tuning	A-B: 0, G-M: 0
Picture Control settings ¹	Unmodified
HDR (high dynamic range)	Off ²
Flicker reduction	
Flicker reduction setting	Disable
Flicker reduction indicator	On
Remote control mode (ML-L3)	Off
Multiple exposure	Off ³
Interval timer shooting	Off ⁴



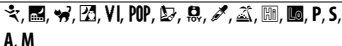

- 1 Current Picture Control only.
- 2 HDR strength is not reset.
- 3 If multiple exposure is currently in progress, shooting will end and multiple exposure will be created from exposures recorded to that point. Gain and number of shots are not reset.
- 4 If interval timer shooting is currently in progress, shooting will end. Starting date, time, shooting interval, number of intervals and shots, and exposure smoothing are not reset.

■ ■ Settings Accessible from the Movie Shooting Menu

Option	Default
ISO sensitivity settings	
ISO sensitivity (mode M)	100
Auto ISO control (mode M)	Off
Maximum sensitivity	51200
White balance	Same as photo settings
Active D-Lighting	Off
Electronic VR	Off

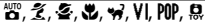
■ ■ Other Settings

Option	Default
Autofocus (viewfinder)	
Autofocus mode	
	AF-S
Other modes	AF-A
AF-area mode	
	Single-point AF
	51-point dynamic-area AF
 VI, POP,  ,  ,  , S, A, M	Auto-area AF
Autofocus (live view)	
Autofocus mode	AF-S
AF-area mode	
 A, M	Wide-area AF
	Normal-area AF
	Face-priority AF

Option	Default
Focus point ¹	Center
Exposure preview	Off
Multi-selector power aperture	Disable
Highlight display	Off
Headphone volume	15
Metering	Matrix
AE lock hold	Off
Bracketing	Off ²
Flash compensation	Off
Exposure compensation	Off
Flash mode	
	Auto
	Auto+red-eye reduction
	Auto+slow sync
T1, P, S, A, M	Fill flash
	Off
FV lock	Off
Flexible program	Off
Exposure delay mode	Off

- 1 Focus point not displayed if auto-area AF is selected for AF-area mode.
- 2 Number of shots is reset to zero. Bracketing increment is reset to 1 EV (exposure/flash bracketing) or 1 (white balance bracketing).  **Auto** is selected for the second shot of two-shot ADL bracketing programs.

Bracketing

(P, S, A, and M Modes Only)

Bracketing automatically varies exposure, flash level, Active D-Lighting (ADL), or white balance slightly with each shot, “bracketing” the current value. Choose in situations in which getting the right settings is difficult and there is not time to check results and adjust settings with each shot, or to experiment with different settings for the same subject.

Bracketing is adjusted using the **Auto bracketing set** option in the photo shooting menu, which contains the following options:

- **AE & flash bracketing:** The camera varies exposure and flash level over a series of photographs (☞ 210). Note that flash bracketing is available in i-TTL and, where supported, auto aperture (⊗A) flash control modes only (☞ 165).
- **AE bracketing:** The camera varies exposure over a series of photographs.
- **Flash bracketing:** The camera varies flash level over a series of photographs.
- **WB bracketing:** The camera creates multiple copies of each photograph, each with a different white balance (☞ 215).
- **ADL bracketing:** The camera varies Active D-Lighting over a series of photographs (☞ 219).

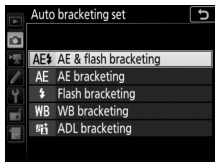

■ Exposure and Flash Bracketing

Vary exposure and/or flash level over a series of photographs.



Exposure modified by:
0 EV



Exposure modified by:
-1 EV



Exposure modified by:
+1 EV

1 Choose the number of shots.

Pressing the **BKT** button, rotate the main command dial to choose the number of shots in the bracketing sequence.

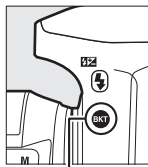

BKT button



Main command dial

Number of shots Exposure and flash bracketing indicator

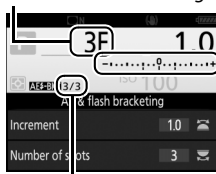

Shots remaining/number of shots

At settings other than zero, a **BKT** icon is displayed in the control panel. **BKT** appears in the viewfinder, while the information display provides a bracketing indicator and an icon showing the type of bracketing:



AE-BKT (exposure and flash bracketing), **AE-BKT** (exposure bracketing only), or **F-BKT** (flash bracketing only).

2 Select an exposure increment.

Pressing the **BKT** button and rotate the sub-command dial to choose the exposure increment.

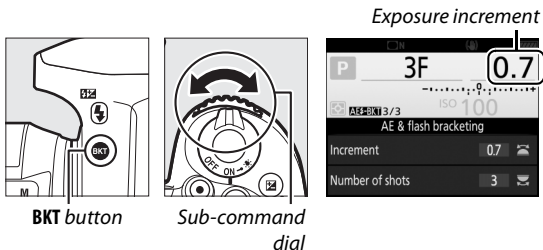

At default settings, the size of the increment can be chosen from 0.3 ($\frac{1}{3}$), 0.7 ($\frac{2}{3}$), 1, 2, and 3 EV. The bracketing programs with an increment of 0.3 ($\frac{1}{3}$) EV are listed below.

Information display	No. of shots	Bracketing order (EVs)
0F 0.3	0	0
+3F 0.3	3	0/+0.3/+0.7
-3F 0.3	3	0/-0.7/-0.3
+2F 0.3	2	0/+0.3
-2F 0.3	2	0/-0.3
3F 0.3	3	0/-0.3/+0.3
5F 0.3	5	0/-0.7/-0.3/+0.3/+0.7
7F 0.3	7	0/-1.0/-0.7/-0.3/+0.3/+0.7/+1.0
9F 0.3	9	0/-1.3/-1.0/-0.7/-0.3/+0.3/+0.7/+1.0/+1.3

Note that for exposure increments of 2 EV or more, the maximum number of shots is 5; if a higher value was selected in Step 1, the number of shots will automatically be set to 5.

3 Frame a photograph, focus, and shoot.

The camera will vary exposure and/or flash level shot-by-shot according to the bracketing program selected. Modifications to exposure are added to those made with exposure compensation (□ 127).



A bracketing progress indicator is displayed while bracketing is in effect. A segment will disappear from the indicator after each shot.

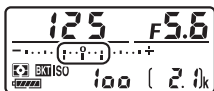

No. shots: 3; increment: 0.7

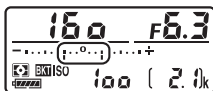

Display after first shot

Live View

In live view, bracketing settings are displayed in the monitor.

See Also

For information on:

- Choosing the size of the increment, see > Custom Setting b2 (**EV steps for exposure ctrl**, □ 262).
- Choosing the order in which bracketing is performed, see > Custom Setting e5 (**Bracketing order**, □ 266).
- Choosing the role of the BKT button, see > Custom Setting f1 (**Custom control assignment**) > **BKT button +** (□ 266).

■ ■ **Canceling Bracketing**

To cancel bracketing, press the **BKT** button and rotate the main command dial until no shots remain in the bracketing sequence and the bracketing indicators in the control panel and viewfinder have turned off. The program last in effect will be restored the next time bracketing is activated. Bracketing can also be cancelled by performing a two-button reset (📖 206), although in this case the bracketing program will not be restored the next time bracketing is activated.

🔍 **Zero Shots**

The live view display shows “-/-” when no shots remain in the bracketing sequence.

🔍 **Exposure and Flash Bracketing**

In continuous release modes (📖 86), shooting will pause after the number of shots specified in the bracketing program have been taken. Shooting will resume the next time the shutter-release button is pressed.

If the memory card fills before all shots in the sequence have been taken, shooting can be resumed from the next shot in the sequence after the memory card has been replaced or shots have been deleted to make room on the memory card. If the camera is turned off before all shots in the sequence have been taken, bracketing will resume from the next shot in the sequence when the camera is turned on.

Exposure Bracketing

The camera modifies exposure by varying shutter speed and aperture (mode **P**), aperture (mode **S**), or shutter speed (modes **A** and **M**). If **On** is selected for **ISO sensitivity settings > Auto ISO sensitivity control** (☐ 120) in modes **P**, **S**, and **A**, the camera will automatically vary ISO sensitivity for optimum exposure when the limits of the camera exposure system are exceeded; in mode **M**, the camera will first use auto ISO sensitivity control to bring exposure as close as possible to the optimum and then bracket this exposure by varying shutter speed.

■ ■ White Balance Bracketing

The camera creates multiple copies of each photograph, each with a different white balance.

1 Choose the number of shots.

Pressing the **BKT** button, rotate the main command dial to choose the number of shots in the bracketing sequence.

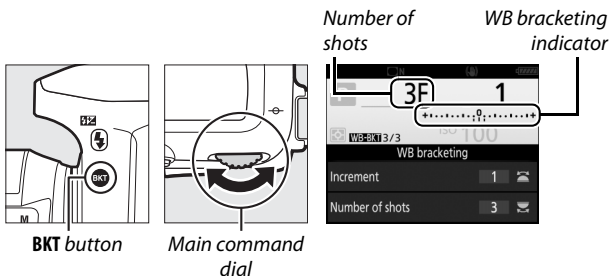

At settings other than zero, **BKT** and **BKT** are displayed respectively in the control panel and viewfinder; a **WB-BKT** icon and a bracketing indicator appear in the information display.

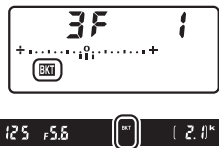

2 Select a white balance increment.

Pressing the **BKT** button, rotate the sub-command dial to choose the white balance adjustment. Each increment is roughly equivalent to 5 mired.

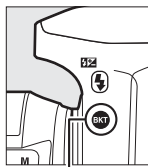

BKT button

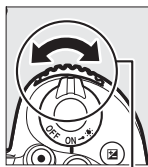

Sub-command dial

White balance increment



Choose from increments of 1 (5 mired), 2 (10 mired), or 3 (15 mired). Higher **B** values correspond to increased amounts of blue, higher **A** values to increased amounts of amber (□ 134). The bracketing programs with an increment of 1 are listed below.

Information display	No. of shots	White balance increment	Bracketing order
B2F 1 +.....;0;.....+	2	1B	0/1B
A2F 1 +.....;0;.....+	2	1A	0/1A
3F 1 +.....;0;.....+	3	1A, 1B	0/1A/1B

3 Frame a photograph, focus, and shoot.

Each shot will be processed to create the number of copies specified in the bracketing program, and each copy will have a different white balance. Modifications to white balance are added to the white balance adjustment made with white balance fine-tuning.



If the number of shots in the bracketing program is greater than the number of exposures remaining, **FuLL** will flash in the control panel, a flashing **FuL** icon will appear in the viewfinder, and the shutter release will be disabled. Shooting can begin when a new memory card is inserted.

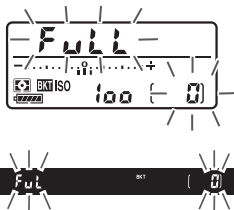

■ ■ **Canceling Bracketing**

To cancel bracketing, press the **BKT** button and rotate the main command dial until no shots remain in the bracketing sequence and the bracketing indicators in the control panel and viewfinder have turned off. The program last in effect will be restored the next time bracketing is activated. Bracketing can also be cancelled by performing a two-button reset (☐ 206), although in this case the bracketing program will not be restored the next time bracketing is activated.

🔍 **Live View**

In live view, bracketing settings are displayed in the monitor.

🔍 **Zero Shots**

The live view display shows “-/-” when no shots remain in the bracketing sequence.

🔍 **White Balance Bracketing**

White balance bracketing is not available at an image quality of NEF (RAW). Selecting an NEF (RAW) or NEF (RAW) + JPEG option cancels white balance bracketing.

White balance bracketing affects only color temperature (the amber-blue axis in the white balance fine-tuning display, ☐ 134). No adjustments are made on the green-magenta axis.

In self-timer mode (☐ 89), the number of copies specified in the white-balance program will be created each time the shutter is released, regardless of the option selected for Custom Setting c3 (**Self-timer**) >

Number of shots (☐ 263).

If the camera is turned off while the memory card access lamp is lit, the camera will power off only after all photographs in the sequence have been recorded.

■ ■ ADL Bracketing

The camera varies Active D-Lighting over a series of exposures.

1 Choose the number of shots.

Pressing the **BKT** button, rotate the main command dial to choose the number of shots in the bracketing sequence.

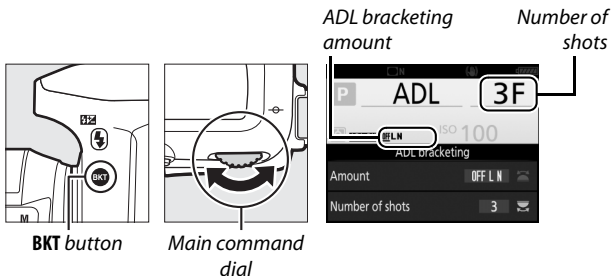

At settings other than zero, **BKT** and **BKT** are displayed respectively in the control panel and viewfinder; a **ADL-BKT** icon and the bracketing amount appear in the information display.

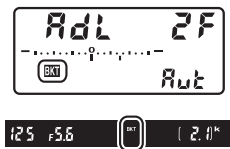

Choose two shots to take one photograph with Active D-Lighting off and another at a selected value. Choose three to five shots to take a series of photographs with Active D-Lighting set to **Off**, **Low**, and **Normal** (three shots), **Off**, **Low**, **Normal**, and **High** (four shots), or **Off**, **Low**, **Normal**, **High**, and **Extra high** (five shots). If you choose more than two shots, proceed to Step 3.

2 Select Active D-Lighting.

Pressing the **BKT** button, rotate the sub-command dial to choose Active D-Lighting.

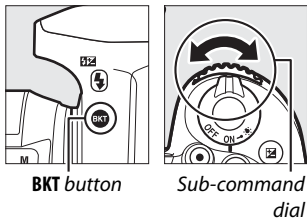

Active D-Lighting is shown in the information display and control panel.

Active D-Lighting	Information display	Control panel display
A Auto	<u>OFF</u> AUTO	BKT Aut
L Low	<u>OFF</u> L	BKT L
N Normal	<u>OFF</u> N	BKT N
H High	<u>OFF</u> H	BKT H
H⁺ Extra high	<u>OFF</u> H ⁺	BKT HP

3 Frame a photograph, focus, and shoot.

The camera will vary Active D-Lighting shot-by-shot according to the bracketing program selected. A bracketing progress indicator is displayed while bracketing is in effect. A segment will disappear from the indicator after each shot.

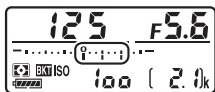

No. shots: 3

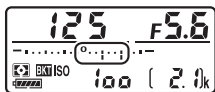

Display after first shot

Live View

In live view, bracketing settings are displayed in the monitor.

■ **Canceling Bracketing**

To cancel bracketing, press the **BKT** button and rotate the main command dial until no shots remain in the bracketing sequence and the bracketing indicators in the control panel and viewfinder have turned off. The program last in effect will be restored the next time bracketing is activated. Bracketing can also be cancelled by performing a two-button reset (📖 206), although in this case the bracketing program will not be restored the next time bracketing is activated.

🔪 **Zero Shots**

The live view display shows “-/-” when no shots remain in the bracketing sequence.

🔪 **ADL Bracketing**

In continuous release modes (📖 86), shooting will pause after the number of shots specified in the bracketing program have been taken. Shooting will resume the next time the shutter-release button is pressed.

If the memory card fills before all shots in the sequence have been taken, shooting can be resumed from the next shot in the sequence after the memory card has been replaced or shots have been deleted to make room on the memory card. If the camera is turned off before all shots in the sequence have been taken, bracketing will resume from the next shot in the sequence when the camera is turned on.

Location Data

The GP-1/GP-1A GPS unit (available separately) can be connected to the camera's accessory terminal (□ 1) using the cable supplied with the GP-1/GP-1A, allowing information on the camera's current position to be recorded when photographs are taken. Turn the camera off before connecting the GP-1/GP-1A; for more information, see the GP-1/GP-1A manual.

■ ■ Setup Menu Options

The **Location data** item in the setup menu contains the options listed below.

- **Position:** The current latitude, longitude, altitude, and Coordinated Universal Time (UTC).
- **External GPS device options > Standby timer:** Choose whether or not the standby timer is enabled when a GPS unit is attached.

Option	Description
Enable	Standby timer enabled. The timer expires automatically if no operations are performed for the period specified in Custom Setting c2 (Standby timer , □ 263), reducing the drain on the battery. If a GP-1 or GP-1A unit is connected, the unit will remain active for a set period after the timer expires; to allow the camera time to acquire location data, the delay is extended by up to one minute after exposure meters are activated or the camera is turned on.
Disable	Standby timer disabled, ensuring uninterrupted recording of location data.

- **External GPS device options > Set clock from satellite:** Select **Yes** to synchronize the camera clock with the time reported by the GPS device.

Smart Devices



To download location data from a smart device and embed it in subsequent photographs, establish a wireless connection and select **Yes** for **Location data** > **Download from smart device** in the setup menu (📖 271).

Coordinated Universal Time (UTC)

UTC data is provided by the GPS device and is independent of the camera clock.

The Icon

Connection status is shown by the  icon:

-  (**static**): Location data acquired.
-  (**flashing**): The GP-1/GP-1A is searching for a signal. Pictures taken while the icon is flashing do not include location data.
- **No icon**: No new location data have been received from the GP-1/GP-1A for at least two seconds. Pictures taken when the  icon is not displayed do not include location data.





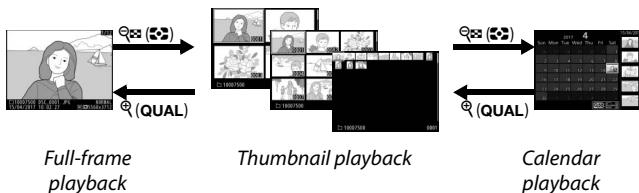

More on Playback

Viewing Images



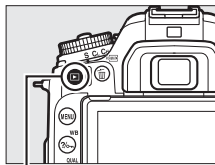

Full-Frame Playback

To play photographs back, press the  button. The most recent photograph will be displayed in the monitor. Additional pictures can be displayed by flicking left or right or pressing  or ; to view additional information on the current photograph, press  or  (book 231).



 button

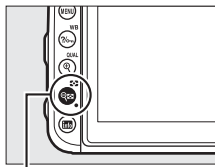

Thumbnail Playback

To view multiple images, press the  button when a picture is displayed full frame. The number of images displayed increases from 4 to 9 to 72 each time the  button is pressed, and decreases with each press of the  button. Slide a finger over the touch screen to scroll up or down or use the multi selector to highlight images.









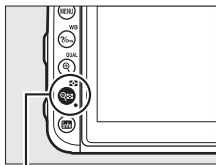





 button

Calendar Playback

To view images taken on a selected date, press the  () button when 72 images are displayed.



 () button

Use the touch screen or multi selector to highlight dates in the date list; the pictures taken on the selected date appear in the thumbnail list. Pressing  or the  () places the cursor in the thumbnail list, where you can use the multi selector to select images for full-frame playback, playback zoom ( 240), protection ( 242), or deletion ( 247), or press and hold the  (**QUAL**) button to view the currently highlighted picture full frame. Press the  () button to return to the date list. To exit to 72-frame playback, press the  (**QUAL**) button when the cursor is in the date list.

Date list



Thumbnail list

Rotate Tall

To display “tall” (portrait-orientation) photographs in tall orientation, select **On** for the **Rotate tall** option in the playback menu (📖 251).

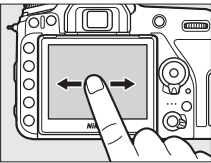
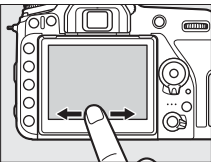

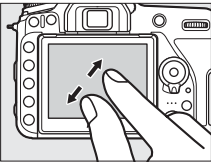

Image Review

When **On** is selected for **Image review** in the playback menu (📖 250), photographs are automatically displayed in the monitor after shooting (because the camera is already in the correct orientation, images are not rotated automatically during image review). In continuous release modes, display begins when shooting ends, with the first photograph in the current series displayed.

Using the Touch Screen

During playback, the touch-sensitive monitor can be used to:

View other images	Flick left or right to view other images.	
Scroll rapidly to other images	In full frame view, you can touch the bottom of the display to display a frame advance bar, then slide your finger left or right to scroll rapidly to other images.	  <i>Frame advance bar</i>
Zoom in (photos only)	Use stretch and pinch gestures to zoom in and out and slide to scroll (see 240). You can also give the display two quick taps to zoom in from full-frame playback or cancel zoom.	

View thumbnails

To “zoom out” to a thumbnail view (☐ 225), use a pinch gesture in full-frame playback. Use pinch and stretch to choose the number of images displayed from 4, 9, and 72 frames.

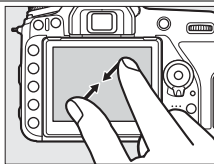

View movies

Tap the on-screen guide to start movie playback (movies are indicated by a 🎬 icon). Tap the display to pause or resume, or tap ⏪ to exit to full-frame playback (note that some of the icons in the movie playback display do not respond to touch-screen operations).



Guide



The *i* Button

Pressing the *i* button during full-frame or thumbnail playback displays the options listed below. Select options using the touch screen or the multi selector and OK button.

- **Rating:** Rate the current picture (📖 243).
- **Select to send to smart device/deselect (photographs only):** Select photos for upload to a smart device.
- **Retouch (photographs only):** Use the options in the retouch menu (📖 275) to create a retouched copy of the current photograph.
- **Volume control (movies only):** Adjust playback volume for movies.
- **Edit movie (movies only):** Edit movies using the options in the edit movie menu (📖 196). Movies can also be edited by pressing the *i* button when movie playback is paused.
- **Choose folder:** Choose a folder for playback. Highlight a folder and press OK to view the pictures in the highlighted folder.

To exit the *i*-button menu and return to playback, press the *i* button again.

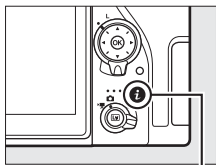

i button

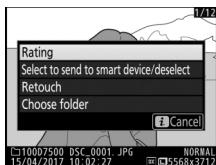
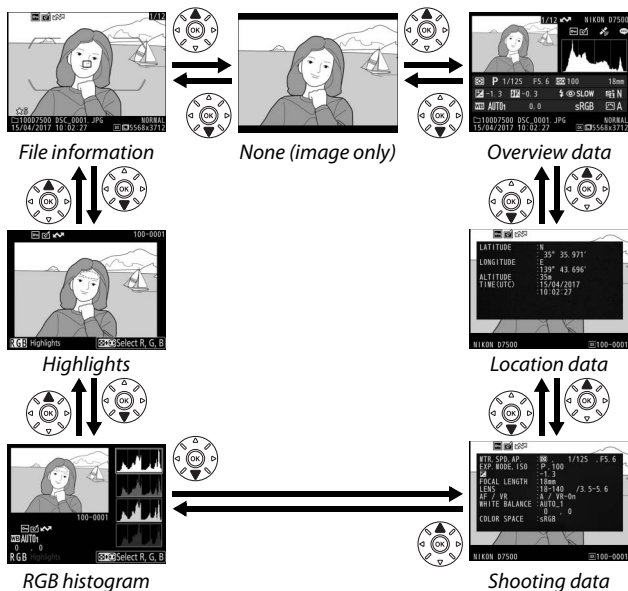
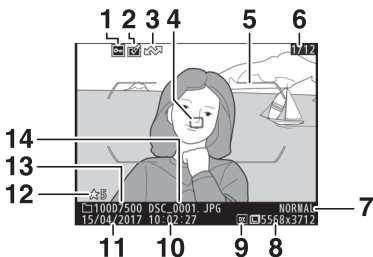

Photo Information

Photo information is superimposed on images displayed in full-frame playback. Press or to cycle through photo information. Note that “image only”, shooting data, RGB histograms, highlights, and overview data are only displayed if corresponding option is selected for **Playback display options** (📖 250). Location data are only displayed if embedded in the picture (📖 223).



File Information



1	Protect status.....	242	8	Image size	99
2	Retouch indicator	275	9	Image area	93
3	Upload marking	245	10	Time of recording	268
4	Focus point*	107	11	Date of recording	268
5	AF area brackets*	51	12	Rating	243
6	Frame number/total number of frames		13	Folder name.....	252
7	Image quality	97	14	File name	252

* Displayed only if **Focus point** is selected for **Playback display options** (☞ 250) and selected photograph was taken using viewfinder.

Highlights

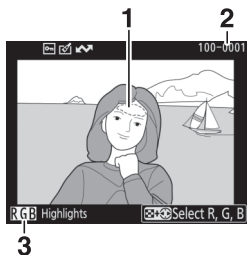

1 Image highlights*

3 Current channel*

2 Folder number—frame number252

*Flashing areas indicate highlights (areas that may be overexposed) for the current channel. Hold button and press or to cycle through channels as follows:

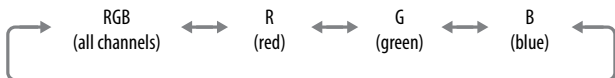
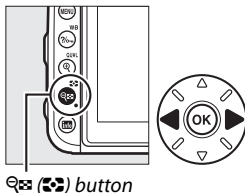

RGB Histogram

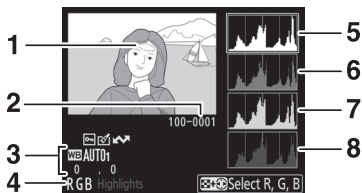

- | | |
|---|--|
| <p>1 Image highlights *</p> <p>2 Folder number—frame number 252</p> <p>3 White balance 130
 Color temperature 137
 White balance fine-tuning..... 134
 Preset manual 139</p> <p>4 Current channel *</p> | <p>5 Histogram (RGB channel). In all histograms, horizontal axis gives pixel brightness, vertical axis number of pixels.</p> <p>6 Histogram (red channel)</p> <p>7 Histogram (green channel)</p> <p>8 Histogram (blue channel)</p> |
|---|--|

* Flashing areas indicate highlights (areas that may be overexposed) for the current channel. Hold () button and press or to cycle through channels as follows:

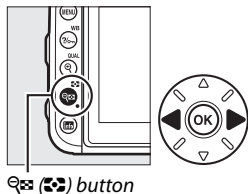

Playback Zoom

To zoom in on the photograph when the histogram is displayed, press **Q** (**QUAL**). Use the **Q** (**QUAL**) and **Q** (**QUAL**) buttons to zoom in and out and scroll the image with the multi selector. The histogram will be updated to show only the data for the portion of the image visible in the monitor.



Histograms

Camera histograms are intended as a guide only and may differ from those displayed in imaging applications. Some sample histograms are shown below:

If the image contains objects with a wide range of brightnesses, the distribution of tones will be relatively even.



If the image is dark, tone distribution will be shifted to the left.



If the image is bright, tone distribution will be shifted to the right.



Increasing exposure compensation shifts the distribution of tones to the right, while decreasing exposure compensation shifts the distribution to the left. Histograms can provide a rough idea of overall exposure when bright ambient lighting makes it difficult to see photographs in the monitor.

■ Shooting Data

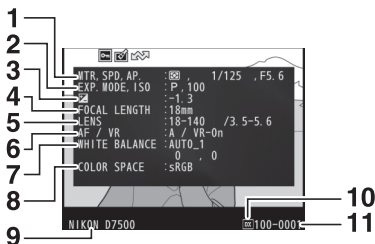

1 Metering	123	7 White balance	130
Shutter speed	74, 76	Color temperature	137
Aperture.....	75, 76	White balance fine-tuning ...	134
2 Shooting mode	6	Preset manual	139
ISO sensitivity ¹	118	8 Color space	254
3 Exposure compensation	127	9 Camera name	
Optimal exposure tuning ²	262	10 Image area	93
4 Focal length	284	11 Folder number—frame	
5 Lens data	279	number	252
6 Focus mode.....	100, 115		
Lens VR (vibration reduction) ³			

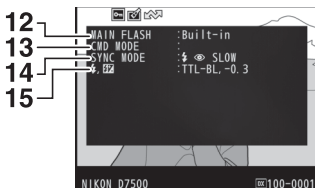

12 Flash type		15 Flash control	164
13 Remote flash control		Flash compensation	167
14 Flash mode.....	159		

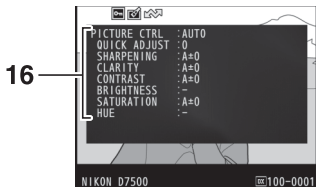

16 Picture Control⁴ 148

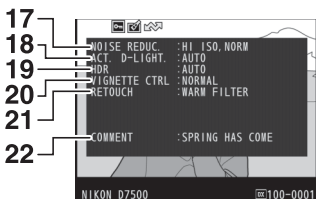

17 High ISO noise reduction	255	20 Vignette control	255
Long exposure noise reduction	255	21 Retouch history	275
18 Active D-Lighting	153	22 Image comment	270
19 HDR strength	155		

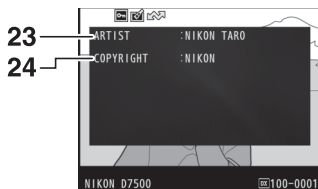

23 Name of photographer⁵ 271 **24** Copyright holder⁵ 271

- 1 Displayed in red if photo was taken with auto ISO sensitivity control on.
- 2 Displayed if Custom Setting b6 (**Fine-tune optimal exposure**,  262) has been set to a value other than zero for any metering method.
- 3 Displayed only if VR lens is attached.
- 4 Items displayed vary with Picture Control selected.
- 5 The fifth page of the shooting data is only displayed if copyright information was recorded with the photograph using the **Copyright information** option in the setup menu.

■■ Location Data

The latitude, longitude, and other location data are supplied by and vary with the GPS or smart device ( 223). In the case of movies, the data give the location at the start of recording.

Overview Data

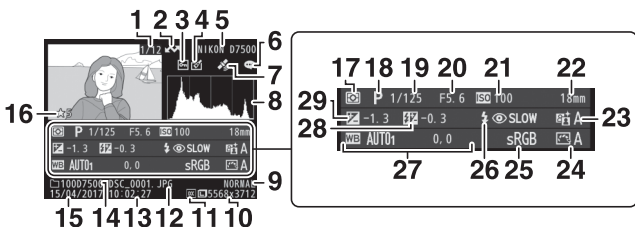

1	Frame number/total number of images	16	Rating	243	
2	Upload marking	245	17	Metering	123
3	Protect status	242	18	Shooting mode	6
4	Retouch indicator	275	19	Shutter speed	74, 76
5	Camera name		20	Aperture.....	75, 76
6	Image comment indicator.....	270	21	ISO sensitivity*	118
7	Location data indicator	223	22	Focal length	284
8	Histogram showing the distribution of tones in the image (□ 235).		23	Active D-Lighting	153
9	Image quality.....	97	24	Picture Control	148
10	Image size.....	99	25	Color space.....	254
11	Image area.....	93	26	Flash mode.....	160, 162
12	File name	252	27	White balance.....	130
13	Time of recording	268		Color temperature	137
14	Folder name	252		White balance fine-tuning....	134
15	Date of recording	268		Preset manual	139
			28	Flash compensation.....	167
				Commander mode	
			29	Exposure compensation	127

* Displayed in red if photo was taken with auto ISO sensitivity control on.

Taking a Closer Look: Playback Zoom

To zoom in on an image displayed in full-frame playback, press the **QUAL** button or give the display two quick taps. The following operations can be performed while zoom is in effect:

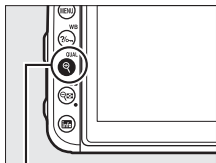

QUAL button

To	Description
Zoom in or out/ view other areas of image	<p>Press QUAL or use stretch gestures to zoom in to a maximum of approximately 34× (large images in 24 × 16/ DX format), 26× (medium images) or 17× (small images). Press QUAL or use pinch gestures to zoom out. While a photo is zoomed in, use the multi selector or slide a finger over the screen to view areas of the image not visible in the monitor. Keep the multi selector pressed to scroll rapidly to other areas of the frame. A navigation window is displayed when the zoom ratio is altered; the area currently visible in the monitor is indicated by a yellow border. The bar under the navigation window shows the zoom ratio, turning green at a ratio of 1 : 1.</p>  An illustration showing a zoomed-in view of a woman's face. A smaller inset window in the bottom right corner shows the full original image. At the bottom of the screen, there is a navigation bar with a yellow border and a zoom ratio indicator.

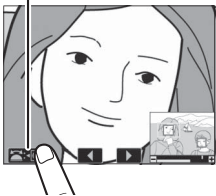
To	Description
Crop image	To crop the image to the area currently visible in the monitor, press i , highlight Quick crop , and press OK . Note that Quick crop is not available when the RGB histogram is displayed (□ 235).
Select faces	<p>Faces detected during zoom are indicated by white borders in the navigation window. Rotate the sub-command dial or tap the on-screen guide to view other faces.</p> <p><i>On-screen guide</i></p> 
View other images	Rotate the main command dial or tap the ◀ or ▶ icons at the bottom of the display to view the same location in other photos at the current zoom ratio. Playback zoom is cancelled when a movie is displayed.
Change protect status	Press W/B to protect or remove protection from images (□ 242).
Return to shooting mode	Press the shutter-release button halfway or press the ▶ button to exit to shooting mode.
Display menus	Press MENU to view the menus (□ 250).

Protecting Photographs from Deletion

In full-frame, zoom, thumbnail, and calendar playback, the **?** (WB) button can be used to protect photographs from accidental deletion. Protected files can not be deleted using the **?** (FORMAT) button or the **Delete** option in the playback menu. Note that protected images *will* be deleted when the memory card is formatted (□ 268).

To protect a photograph:

1 Select an image.

Display the image in full-frame playback or playback zoom or highlight it in the thumbnail list.

2 Press the **?** (WB) button.

The photograph will be marked with a **?** icon. To remove protection from the photograph so that it can be deleted, display the photograph or highlight it in the thumbnail list and then press the **?** (WB) button.

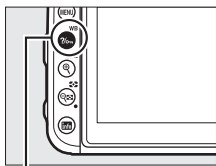

? (WB) button



? Removing Protection from All Images

To remove protection from all images in the folder or folders currently selected in the **Playback folder** menu, press the **?** (WB) and **?** (FORMAT) buttons together for about two seconds during playback.

Rating Pictures

Rate pictures or mark them as candidates for later deletion. Ratings can also be viewed in ViewNX-i and Capture NX-D. Rating is not available with protected images.

Rating Individual Pictures

1 Select an image.

Display or highlight the image.

2 Display playback options.

Press the **i** button to display playback options.

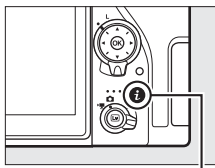

i button

3 Select Rating.

Highlight **Rating** and press **OK**.

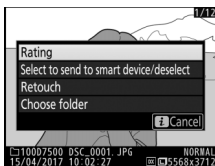

4 Choose a rating.

Press **←** or **→** to choose a rating of from zero to five stars, or select **✖** to mark the picture as a candidate for later deletion. Press **OK** to complete the operation.



Rating Multiple Pictures







Use the **Rating** option in the playback menu to rate multiple pictures.

1 Select Rating.

Highlight **Rating** in the playback menu and press .



2 Rate pictures.

Use the multi selector to highlight pictures (to view the currently highlighted picture full frame, press and hold the /QUAL button) and then press and hold the  button while pressing  or  to choose a rating of from zero to five stars, or select  to mark the picture as a candidate for later deletion. Press  to complete the operation.



Selecting Photos for Upload

Follow the steps below to select photos for upload to the smart device. Movies can not be selected for upload.

Selecting Individual Photos

1 Select a photo.

Display the photo or highlight it in the thumbnail list in thumbnail playback.

2 Display playback options.

Press the **i** button to display playback options.

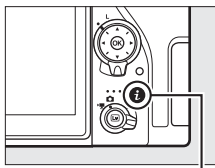

i button

3 Choose **Select to send to smart device/deselect**.

Highlight **Select to send to smart device/deselect** and press **OK**.

Pictures selected for upload are indicated by a  icon; to deselect, display or highlight the image and repeat Steps 2 and 3.

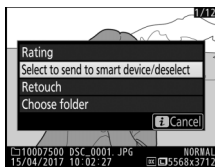

Selecting Multiple Photos

Follow the steps below to change the upload status of multiple photos.

1 Choose **Select image(s)**.

In the playback menu, select **Select to send to smart device**, then highlight **Select image(s)** and press **OK**.



2 Select photos.

Use the multi selector to highlight photos and press the **Multi-selector** button to select or deselect (to view the highlighted picture full screen, press and hold the **QUAL** button). Selected photos are marked by a **checkmark** icon.

3 Press **OK**.

Press **OK** to complete the operation.

✍ Deselecting All Photos

To deselect all photos, select **Select to send to smart device** in the playback menu, highlight **Deselect all**, and press **OK**. A confirmation dialog will be displayed; highlight **Yes** and press **OK** to remove upload marking from all photos on the memory card.

Deleting Photographs

To delete the current photograph, press the  (FORMAT) button. To delete multiple selected photographs, all photographs taken on a selected date, or all photographs in the current playback folder, use the **Delete** option in the playback menu. Once deleted, photographs can not be recovered. Note that pictures that are protected or hidden can not be deleted.

During Playback

Press the  (FORMAT) button to delete the current photograph.

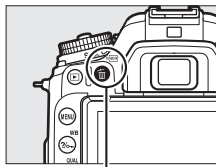

1 Press the (FORMAT) button.

A confirmation dialog will be displayed.



 (FORMAT) button

2 Press the (FORMAT) button again.

To delete the photograph, press the  (FORMAT) button. To exit without deleting the photograph, press the  button.

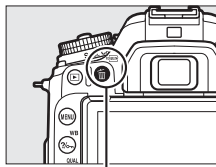

 (FORMAT) button

Calendar Playback



During calendar playback, you can delete all photographs taken on a selected date by highlighting the date in the date list and pressing the  (FORMAT) button (□ 226).

See Also

For information on choosing the image displayed after an image is deleted, see  > **After delete** (□ 251).



The Playback Menu

The **Delete** option in the playback menu contains the following options. Note that depending on the number of images, some time may be required for deletion.

Option	Description
 Selected	Delete selected pictures (📄 248).
 Select date	Delete all pictures taken on a selected date (📄 249).
ALL All	Delete all pictures in the folder currently selected for playback (📄 250).

■ Selected: Deleting Selected Photographs

1 Select pictures.

Use the multi selector to highlight a picture and press the  button to select or deselect. Selected pictures are marked by a  icon (to view the highlighted picture full screen, press and hold the /QUAL button). Repeat as desired to select additional pictures.

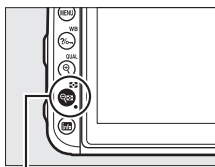

 button



2 Press to complete the operation.

A confirmation dialog will be displayed; highlight **Yes** and press .



■ Select Date: Deleting Photographs Taken on a Selected Date

1 Select dates.

Highlight a date and press **▶** to select all pictures taken on the highlighted date. Selected dates are marked with a **☑** icon. Repeat as desired to select additional dates; to deselect a date, highlight it and press **▶**.

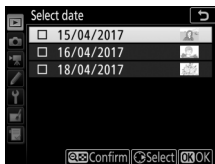

2 Press **OK** to complete the operation.

A confirmation dialog will be displayed; highlight **Yes** and press **OK**.



Menu List

This section lists the options available in the camera menus. For more information, see the *Menu Guide*.

▶ The Playback Menu: *Managing Images*

Delete

Selected Delete multiple images (📖 248).

Select date

All

Playback folder

(defaults to **All**)

(Folder name) Choose a folder for playback.

All

Current

Hide image

Select/set Hide or reveal images. Hidden images are displayed only in the “Hide image” menu and cannot be played back.

Select date

Deselect all

Playback display options

Basic photo info Choose the information available in the playback photo information display (📖 231).

Focus point

Additional photo info

None (image only)

Highlights

RGB histogram

Shooting data

Overview

Image review

(defaults to **Off**)

On

Off

Choose whether pictures are automatically displayed in the monitor immediately after shooting (📖 227).

After delete (defaults to Show next)	
Show next	Choose the picture displayed after an image is deleted.
Show previous	
Continue as before	
Auto image rotation (defaults to On)	
On	Choose whether to record camera orientation when taking photographs.
Off	
Rotate tall (defaults to On)	
On	Choose whether to rotate “tall” (portrait-orientation) pictures for display during playback (☞ 227).
Off	
Slide show	
Start	View a slide show of the pictures in the current playback folder.
Image type	
Frame interval	
Rating	
	Rate multiple pictures (☞ 244).
Select to send to smart device	
Select image(s)	Select photos for upload to a smart device (☞ 246).
Deselect all	

The Photo Shooting Menu: *Photo Shooting Options*

Reset photo shooting menu

Yes	Select Yes to restore photo shooting menu options to their default values.
No	

Storage folder

Rename	Select the folder in which subsequent images will be stored.
Select folder by number	
Select folder from list	

File naming

File naming	Choose the three-letter prefix used in naming the image files in which photographs are stored. The default prefix is "DSC".
-------------	---

Flash control

Flash control mode (built-in)	Choose the flash control mode or adjust settings for wireless flash photography (□ 164).
Flash control mode (external)	
Wireless flash options	
Group flash options	
Radio remote flash info	

Choose image area

(defaults to **DX (24×16)**)

DX (24×16)	Choose the image area (□ 93).
1.3× (18×12)	

Image quality		(defaults to JPEG normal)
NEF (RAW) + JPEG fine★	Choose a file format and compression ratio (image quality, 97). The compression for options indicated by a star (“★”) prioritizes quality, while that for images without a star gives priority to reducing file size.	
NEF (RAW) + JPEG fine		
NEF (RAW) + JPEG normal★		
NEF (RAW) + JPEG normal		
NEF (RAW) + JPEG basic★		
NEF (RAW) + JPEG basic		
NEF (RAW)		
JPEG fine★		
JPEG fine		
JPEG normal★		
JPEG normal		
JPEG basic★		
JPEG basic		
Image size		(defaults to Large)
Large	Choose the image size, in pixels (99).	
Medium		
Small		
NEF (RAW) recording		
NEF (RAW) compression	Choose the type of compression and the bit depth for NEF (RAW) images.	
NEF (RAW) bit depth		
ISO sensitivity settings		
ISO sensitivity	Adjust ISO sensitivity settings for photographs (118, 120).	
Auto ISO sensitivity control		

White balance (defaults to Auto)	
Auto	Match white balance to the light source (☞ 130).
Incandescent	
Fluorescent	
Direct sunlight	
Flash	
Cloudy	
Shade	
Choose color temp.	
Preset manual	
Set Picture Control (defaults to Auto)	
Auto	Choose how new photos will be processed. Select according to the type of scene or your creative intent (☞ 148).
Standard	
Neutral	
Vivid	
Monochrome	
Portrait	
Landscape	
Flat	
Manage Picture Control	
Save/edit	Create custom Picture Controls (☞ 149).
Rename	
Delete	
Load/save	
Color space (defaults to sRGB)	
sRGB	Choose a color space for photographs.
Adobe RGB	
Active D-Lighting (defaults to Off)	
Auto	Preserve details in highlights and shadows, creating photographs with natural contrast (☞ 153).
Extra high	
High	
Normal	
Low	
Off	

Long exposure NR		(defaults to Off)
On	Reduce “noise” (bright spots or fog) in	
Off	photos taken at slow shutter speeds.	
High ISO NR		(defaults to Normal)
High	Reduce “noise” (randomly-spaced	
Normal	bright pixels) in photos taken at high	
Low	ISO sensitivities.	
Off		
Vignette control		(defaults to Normal)
High	Reduce the drop in brightness at the	
Normal	edges of photographs when using type	
Low	G, E, and D lenses (PC lenses excluded).	
Off	The effect is most noticeable at	
		maximum aperture.
Auto distortion control		(defaults to Off)
On	Reduce barrel distortion when shooting	
Off	with wide-angle lenses and to reduce	
		pin-cushion distortion when shooting
		with long lenses.
Flicker reduction		
Flicker reduction setting	This option takes effect during	
Flicker reduction indicator	viewfinder photography. Select Enable	
		for Flicker reduction setting to adjust
		shot timing to reduce the effects of
		flicker under fluorescent or mercury
		vapor lighting. The Flicker reduction
		indicator item controls whether a
		FLICKER icon is displayed in the
		viewfinder when flicker is detected.

Remote control mode (ML-L3)		(defaults to Off)
Delayed remote		Choose how the camera behaves when used with an ML-L3 remote control.
Quick-response remote		
Remote mirror-up		
Off		
Auto bracketing set		(defaults to AE & flash bracketing)
AE & flash bracketing		Choose the setting or settings bracketed when auto bracketing is in effect (□ 209).
AE bracketing		
Flash bracketing		
WB bracketing		
ADL bracketing		
Multiple exposure		
Multiple exposure mode		Record from two to ten NEF (RAW) exposures as a single photograph.
Number of shots		
Overlay mode		
Keep all exposures		
HDR (high dynamic range)		
HDR mode		Preserve details in highlights and shadows when photographing high-contrast scenes (□ 155).
HDR strength		
Interval timer shooting		
Start		Take photographs at the selected interval until the specified number of shots has been recorded.
Start options		
Interval		
No. of intervals×shots/interval		
Exposure smoothing		

The Movie Shooting Menu: *Movie Shooting Options*

Reset movie shooting menu

Yes	Select Yes to restore movie shooting menu options to their default values.
No	

File naming

Choose the three-letter prefix used in naming the image files in which movies are stored. The default prefix is "DSC".

Choose image area (defaults to **DX**)

DX	Choose the image area (<input type="checkbox"/> 190).
1.3×	

Frame size/frame rate (defaults to **1920×1080; 60p**)

3840×2160; 30p	Choose movie frame size (in pixels) and frame rate (<input type="checkbox"/> 188).
3840×2160; 25p	
3840×2160; 24p	
1920×1080; 60p	
1920×1080; 50p	
1920×1080; 30p	
1920×1080; 25p	
1920×1080; 24p	
1280×720; 60p	
1280×720; 50p	

Movie quality (defaults to **High quality**)

High quality	Choose movie quality (<input type="checkbox"/> 188).
Normal	

Movie file type (defaults to **MOV**)

MOV	Choose the movie file type.
MP4	

ISO sensitivity settings

Maximum sensitivity	Adjust ISO sensitivity settings for movies.
Auto ISO control (mode M)	
ISO sensitivity (mode M)	

White balance (defaults to **Same as photo settings**)

Same as photo settings	Choose the white balance for movies (📖 130). Select Same as photo settings to use the option currently selected for photos.
Auto	
Incandescent	
Fluorescent	
Direct sunlight	
Cloudy	
Shade	
Choose color temp.	
Preset manual	

Set Picture Control (defaults to **Same as photo settings**)

Same as photo settings	Choose a Picture Control for movies (📖 148). Select Same as photo settings to use the option currently selected for photos.
Auto	
Standard	
Neutral	
Vivid	
Monochrome	
Portrait	
Landscape	
Flat	

Manage Picture Control

Save/edit	Create custom Picture Controls (📖 149).
Rename	
Delete	
Load/save	

Active D-Lighting (defaults to **Off**)

Same as photo settings	Preserve details in highlights and shadows, creating movies with natural contrast (📖 153). Select Same as photo settings to use the option currently selected for photos.
Extra high	
High	
Normal	
Low	
Off	

High ISO NR	(defaults to Normal)
High	Reduce “noise” (randomly-spaced bright pixels) in movies recorded at high ISO sensitivities.
Normal	
Low	
Off	
Flicker reduction	(defaults to Auto)
Auto	Reduce flicker and banding caused by fluorescent or mercury-vapor lighting during live view and movie recording (☐ 179).
50 Hz	
60 Hz	
Microphone sensitivity	(defaults to Auto sensitivity)
Auto sensitivity	Turn the built-in or external microphones (☐ 183) on or off or adjust microphone sensitivity.
Manual sensitivity	
Microphone off	
Frequency response	(defaults to Wide range)
Wide range	Choose the frequency response for the built-in and external microphones (☐ 183).
Vocal range	
Wind noise reduction	(defaults to Off)
On	Choose whether to enable the built-in microphone’s low-cut filter to reduce wind noise.
Off	
Electronic VR	(defaults to Off)
On	Choose whether to enable electronic vibration reduction in movie mode.
Off	
Time-lapse movie	
Start	The camera automatically takes photos at selected intervals to create a silent time-lapse movie.
Interval	
Shooting time	
Exposure smoothing	

Custom Settings: Fine-Tuning Camera Settings

Reset custom settings

Yes	Select Yes to restore Custom Settings to their default values.
No	

a Autofocus

a1 AF-C priority selection (defaults to **Release**)

Release	When AF-C is selected for viewfinder photography, this option controls whether photographs can be taken whenever the shutter-release button is pressed (<i>release priority</i>) or only when the camera is in focus (<i>focus priority</i>).
Focus	

a2 AF-S priority selection (defaults to **Focus**)

Release	When AF-S is selected for viewfinder photography, this option controls whether photographs can be taken only when the camera is in focus (<i>focus priority</i>) or whenever the shutter-release button is pressed (<i>release priority</i>).
Focus	

a3 Focus tracking with lock-on (defaults to **3 (Normal)**)

5 (Long)–1 (Short), Off	Choose how continuous-servo autofocus adjusts to sudden large changes in the distance to the subject (continuous-servo AF takes effect when AF-C is selected for focus mode during viewfinder photography or if the camera selects continuous-servo in AF-A mode).
-------------------------	--

a4 Number of focus points (defaults to **51 points**)

51 points	Choose the number of focus points available for manual focus-point selection in the viewfinder.
11 points	

a5 Store points by orientation (defaults to Off)	
Yes	Choose whether the viewfinder stores the focus points for vertical and horizontal orientations separately.
Off	
a6 AF activation (defaults to Shutter/AF-ON)	
Shutter/AF-ON	Choose whether the camera focuses when the shutter-release button is pressed halfway. If AF-ON only is selected, the camera will not focus when the shutter-release button is pressed halfway.
AF-ON only	
a7 Focus point wrap-around (defaults to No wrap)	
Wrap	Choose whether viewfinder focus-point selection “wraps around” from one edge of the display to another.
No wrap	
a8 Focus point options	
Focus point illumination	Adjust settings for the focus-point display in the viewfinder.
Manual focus mode	
a9 Built-in AF-assist illuminator (defaults to On)	
On	Choose whether the built-in AF-assist illuminator lights to assist the focus operation when lighting is poor.
Off	
a10 Manual focus ring in AF mode (defaults to Enable)	
Enable	This option is available with compatible lenses. Select Disable to disable focus using the focus ring in autofocus mode.
Disable	
b Metering/exposure	
b1 ISO sensitivity step value (defaults to 1/3 step)	
1/3 step	Select the increments used when making adjustments to ISO sensitivity.
1/2 step	

b2 EV steps for exposure cntrl (defaults to 1/3 step)	
1/3 step	Select the increments used when making adjustments to shutter speed, aperture, exposure and flash compensation, and bracketing.
1/2 step	
b3 Easy exposure compensation (defaults to Off)	
On (Auto reset)	Choose whether exposure compensation can be adjusted solely by rotating a command dial, without pressing the  button.
On	
Off	
b4 Matrix metering (defaults to Face detection on)	
Face detection on	Choose Face detection on to enable face detection when shooting portraits with matrix metering during viewfinder photography (□ 123).
Face detection off	
b5 Center-weighted area (defaults to ϕ 8 mm)	
ϕ 6 mm— ϕ 13 mm, Average	Choose the size of the area given the most weight when center-weighted metering is used in viewfinder photography.
b6 Fine-tune optimal exposure (defaults to No)	
Yes	Fine-tune exposure for each metering method. Higher values produce brighter exposures, lower values darker exposures.
No	
c Timers/AE lock	
c1 Shutter-release button AE-L (defaults to Off)	
On (half press)	Choose whether exposure locks when the shutter-release button is pressed.
On (burst mode)	
Off	

c2 Standby timer (defaults to 6 s)	
4 s–30 min, No limit	Choose how long the camera continues to meter exposure when no operations are performed (□ 54).
c3 Self-timer	
Self-timer delay	Choose the length of the shutter release delay, the number of shots taken, and the interval between shots in self-timer mode.
Number of shots	
Interval between shots	
c4 Monitor off delay	
Playback	Choose how long the monitor remains on when no operations are performed.
Menus	
Information display	
Image review	
Live view	
c5 Remote on duration (ML-L3) (defaults to 1 min)	
1 min–15 min	Select the length of time the camera will wait for a signal from the remote before cancelling remote control mode (□ 175).
d Shooting/display	
d1 CL mode shooting speed (defaults to 3 fps)	
7 fps–1 fps	Choose the frame advance rate for CL (continuous low-speed) mode.
d2 Max. continuous release (defaults to 100)	
1–100	Choose the maximum number of shots that can be taken in a single burst in continuous release mode.

d3 Exposure delay mode (defaults to Off)	
3 s–1 s, Off	In situations where the slightest camera movement can blur pictures, select 1 s , 2 s , or 3 s to delay shutter release until approximately one, two, or three seconds after the mirror is raised.
d4 Electronic front-curtain shutter (defaults to Disable)	
Enable	Enable or disable the electronic front-curtain shutter in MUP mode, eliminating blur caused by shutter motion.
Disable	
d5 File number sequence (defaults to On)	
On	Choose how the camera assigns file numbers.
Off	
Reset	
d6 Viewfinder grid display (defaults to Off)	
On	Choose whether to display a framing grid in the viewfinder.
Off	
d7 ISO display (defaults to Show frame count)	
Show ISO sensitivity	Choose whether ISO sensitivity is displayed in the viewfinder in place of the number of exposures remaining.
Show frame count	
d8 LCD illumination (defaults to Off)	
On	Choose whether the control panel is illuminated while the standby timer is active.
Off	

The Electronic Front-Curtain Shutter

A type G, E, or D lens is recommended; select **Disable** if you notice lines or fog when shooting with other lenses. The fastest shutter speed and maximum ISO sensitivity available with the electronic front-curtain shutter are $\frac{1}{2000}$ s and ISO 51200, respectively. The electronic front-curtain shutter cannot be used with the ML-L3 remote control.

d9 Optical VR		(defaults to On)
On	Turn vibration control on or off. This	
Off	item is available only with lenses that support it.	
<hr/>		
e Bracketing/flash		
e1 Flash sync speed		(defaults to 1/250 s)
1/320 s (Auto FP), 1/250 s (Auto FP), 1/250 s–1/60 s	Choose a flash sync speed.	
e2 Flash shutter speed		(defaults to 1/60 s)
1/60 s–30 s	Choose the slowest shutter available when the flash is used in modes P and A .	
e3 Exposure comp. for flash		(defaults to Entire frame)
Entire frame	Choose how the camera adjusts flash	
Background only	level when exposure compensation is used.	
<hr/>		

🔍 Fixing Shutter Speed at the Flash Sync Speed Limit

To fix shutter speed at the sync speed limit in mode **S** or **M**, select the next shutter speed after the slowest possible shutter speed (30 s or -). An **X** (flash sync indicator) will be displayed in the viewfinder and control panel.

🔍 Auto FP High-Speed Sync

Selecting an “Auto FP” option allows compatible flash units to be used at the highest shutter speed supported by the camera. Auto FP high-speed sync is enabled automatically at shutter speeds faster than the chosen flash sync speed (1/320 s or 1/250 s depending on the option selected), allowing wider apertures for reduced depth of field even in daylight. If the shutter-speed displays in the control panel and viewfinder show a value equal to the flash sync speed in modes **P** and **A**, auto FP high-speed sync will still be activated if the actual shutter speed is even slightly faster. The information display flash mode indicator shows “FP” when auto FP high-speed sync is active.





e4 Auto ISO sensitivity control (defaults to **Subject and background**)

Subject and background	Choose whether auto ISO sensitivity control for flash photography is adjusted to correctly expose both the subject and background or the main subject only.
Subject only	

e5 Bracketing order (defaults to **MTR > under > over**)

MTR > under > over	Choose the bracketing order for exposure, flash, and white balance bracketing.
Under > MTR > over	

f Controls**f1 Custom control assignment**

Fn1 button	Choose the roles assigned to camera controls, either alone or in combination with the command dials.
Fn1 button + 	
Fn2 button	
Fn2 button + 	
AE-L/AF-L button	
AE-L/AF-L button + 	
BKT button + 	
Movie record button + 	

f2 OK button

Shooting mode	Choose the role played by the  button.
Playback mode	
Live view	

f3 Customize command dials



Reverse rotation	Choose the roles played by the main and sub-command dials.
Change main/sub	
Menus and playback	
Sub-dial frame advance	

f4 Release button to use dial(defaults to **No**)

Yes

Selecting **Yes** allows adjustments that are normally made by holding a button and rotating a command dial to be made by rotating the command dial after the button is released. Setting ends when the button is pressed again, the shutter-release button is pressed halfway, or the standby timer expires.

f5 Reverse indicators(defaults to )

If  (-0+) is selected, the exposure indicators in the control panel, viewfinder, and information display are displayed with negative values on the left and positive values on the right. Select  (+0-) to display positive values on the left and negative values on the right.

g Movie**g1 Custom control assignment**

Fn1 button

Fn2 button

AE-L/AF-L button

Shutter-release button

Choose the roles assigned to camera controls when the live view selector is rotated to  in live view. Note that if **Record movies** is selected for **Shutter-release button**, the shutter-release button can not be used for any operation other than recording movies.

Y The Setup Menu: *Camera Setup*

Format memory card

To begin formatting, select **Yes**. *Note that formatting permanently deletes all pictures and other data on the card.* Before formatting, be sure to make backup copies as required.

Save user settings

Save to U1

Assign frequently-used settings to the **U1** and **U2** positions on the mode dial (☞ 83).

Save to U2

Reset user settings

Reset U1

To reset settings for **U1** or **U2** to default values (☞ 85).

Reset U2

Language

See page 323.

Choose a language for camera menus and messages.

Time zone and date

Time zone

Change time zones, set the camera clock, synchronize the clock with the clock on a smart device, choose the date display order, and turn daylight saving time on or off.

Date and time

Sync with smart device

Date format

Daylight saving time

Formatting Memory Cards

Do not turn the camera off or remove the battery or memory card during formatting.

In addition to the **Format memory card** option in the setup menu, memory cards can be formatted using the  (FORMAT) and **ISO** (FORMAT) buttons: keep both buttons pressed simultaneously until formatting indicators are displayed and then press the buttons again to format the card.

Monitor brightness

Menus/playback Adjust the brightness of the menu, playback, and live view displays.
Live view

Monitor color balance

Adjust monitor color balance.

Virtual horizon

View a virtual horizon based on information from the camera tilt sensor.

Information display

(defaults to **Auto**)

Auto Adjust the information display for different viewing conditions.
Manual

Auto info display

(defaults to **On**)

On Choose whether the information display appears after the shutter-release button is pressed halfway.
Off

Info display auto off

(defaults to **On**)

On Choose whether the eye sensor turns the information display off when you put your eye to the viewfinder.
Off

AF fine-tune

AF fine-tune (On/Off) Fine-tune focus for different lens types.
Saved value AF tuning is not recommended in most situations and may interfere with normal focus; use only when required.
Default Auto fine-tuning is available in live view; more information is available in a *Menu Guide* that can be downloaded from the Nikon website (□ iii).
List saved values

Clean image sensor







Clean now Vibrate the image sensor to remove dust (□ 289).
Clean at startup/shutdown

Lock mirror up for cleaning

Lock the mirror up so that dust can be removed from the image sensor with a blower (□ 292).

Image Dust Off ref photo	
Start	Acquire reference data for the Image Dust Off option in Capture NX-D (□ iv).
Clean sensor and then start	Dust Off option in Capture NX-D (□ iv).
Image comment	
Attach comment	Add a comment to new photographs as they are taken. Comments can be viewed as metadata in ViewNX-i or Capture NX-D (□ iv).
Input comment	

Text Entry

A keyboard is displayed when text entry is required. Enter text by tapping the characters on the touch screen (to cycle through the upper- and lower-case and symbol keyboards, tap the keyboard selection button). You can also use the multi selector to highlight the desired character in the keyboard area and press  to insert the highlighted character at the current cursor position (note that if a character is entered when the field is full, the last character in the field will be deleted). To delete the character under the cursor, press the  () button. To move the cursor to a new position, tap the display or hold the  button and press  or . To complete entry and return to the previous menu, press the  (**QUAL**) button.



Keyboard area

Keyboard selection

Copyright information

Attach copyright information	Add copyright information to new photographs as they are taken.
Artist	
Copyright	Copyright information can be viewed as metadata in ViewNX-i or in Capture NX-D (□ iv).

Beep options

Beep on/off	Choose the pitch and volume of the beep.
Volume	
Pitch	

Touch controls

Enable/disable touch controls	Adjust touch control settings (□ 14).
Full-frame playback flicks	

Flash warning

(defaults to **On**)

On	If On is selected, the flash-ready indicator (⚡) will blink if the flash is required to ensure optimal exposure.
Off	

HDMI

Output resolution	Adjust settings for connection to HDMI devices.
Advanced	

Location data

Download from smart device	Adjust location data settings (□ 223).
Position	
External GPS device options	

Wireless remote (WR) options

LED lamp	Adjust LED lamp and link mode settings for optional wireless remote controllers.
Link mode	

Assign remote (WR) Fn button	(defaults to None)
FV lock	Choose the role played by the Fn button on optional wireless remote controllers.
AE/AF lock	
AE lock only	
AE lock (Reset on release)	
AF lock only	
AF-ON	
Modeling flash	
Flash off	
+ NEF (RAW)	
Live view	
Same as camera Fn1 button	
Same as camera Fn2 button	
Same as camera  button	
None	

Airplane mode	(defaults to Disable)
Enable	Enable airplane mode to disable the wireless features of Eye-Fi cards and Bluetooth and Wi-Fi connections to smart devices. Connections to other devices using a wireless transmitter can only be disabled by removing the transmitter from the camera.
Disable	

Connect to smart device	
Start	To connect a smart device, select Start and follow the on-screen guide.
Password protection	Password protection controls whether Bluetooth connections are password protected.

Send to smart device (auto)		(defaults to Off)
On	Select On to upload photos to a smart device as they are taken.	
Off		
Wi-Fi		
Network settings	Adjust Wi-Fi (wireless LAN) settings for connection to smart devices.	
Current settings		
Reset connection settings		
Bluetooth		
Network connection	Adjust settings for Bluetooth connections to smart devices.	
Paired devices		
Send while off		
Eye-Fi upload		(defaults to Enable)
Enable	Upload pictures to a preselected destination. This option is displayed only when a supported Eye-Fi card is inserted.	
Disable		
Conformity marking		
	View a selection of the standards with which the camera complies.	
Battery info		
	View information on the battery currently inserted in the camera.	
Slot empty release lock		(defaults to Enable release)
Release locked	Choose whether the shutter can be released when no memory card is inserted.	
Enable release		

Save/load settings	
Save settings	Save camera settings to or load camera settings from a memory card. Settings files can be shared with other D7500 cameras.
Load settings	
Reset all settings	
Reset	Reset all settings apart from the options selected for Language and Time zone and date in the setup menu.
Do not reset	
Firmware version	
	View the current camera firmware version.

Reset All Settings

Copyright information and other user-generated entries are also reset. We recommend that you save settings using the **Save/load settings** option in the setup menu before performing a reset.

The Retouch Menu: *Creating Retouched Copies*

NEF (RAW) processing

Select image(s)	Create JPEG copies of NEF (RAW) photographs.
Select date	
Select all images	

Trim

Create a cropped copy of the selected photograph.

Resize

Select image(s)	Create small copies of selected photographs.
Choose size	

D-Lighting

Brighten shadows. Choose for dark or backlit photographs.

Quick retouch

Create copies with enhanced saturation and contrast.

Red-eye correction

Correct “red-eye” in photos taken with a flash.

Straighten

Create straightened copies. Copies can be straightened by up to 5° in increments of approximately 0.25°.

Distortion control



Auto	Create copies with reduced peripheral distortion. Use to reduce barrel distortion in photos taken with wide-angle lenses or pin-cushion distortion in photos taken with telephoto lenses. Select Auto to let the camera correct distortion automatically.
Manual	

Perspective control	Create copies that reduce the effects of perspective taken from the base of a tall object.
Fisheye	Create copies that appear to have been taken with a fisheye lens.
Filter effects	
Skylight	<p>Create the effects of the following filters:</p> <ul style="list-style-type: none"> • Skylight: A skylight filter effect • Warm filter: A warm tone filter effect • Cross screen: Adds starburst effects to light sources • Soft: A soft filter effect
Warm filter	
Cross screen	
Soft	
Monochrome	
Black-and-white	Copy photographs in Black-and-white , Sepia , or Cyanotype (blue and white monochrome).
Sepia	
Cyanotype	
Image overlay	Image overlay combines two existing NEF (RAW) photographs to create a single picture that is saved separately from the originals. Image overlay can only be selected by pressing MENU and selecting  tab.
Color outline	Create an outline copy of a photograph to use as a base for painting.
Photo illustration	Sharpen outlines and simplify coloring for a poster effect.
Color sketch	Create a copy of a photograph that resembles a sketch made with colored pencils.

Miniature effect

Create a copy that appears to be a photo of a diorama. Use the multi selector to choose the position and orientation of the area in focus. Works best with photos taken from a high vantage point.

Selective color

Create a copy in which only selected hues appear in color. Position the cursor over objects with desired colors and press the  **AE-L/AF-L** button. The selected colors (maximum three) appear in the frames at the top of the display; rotate the main command dial to highlight a frame and press  or  to increase or decrease the range of hues selected.

Painting

Create a copy which emphasizes detail and color for a painterly effect.

Edit movie

Choose start/end point

Save selected frame

Trim footage to create edited copies of movies or save selected frames as JPEG stills ( 196).

Side-by-side comparison

Compare retouched copies to the original photographs. **Side-by-side comparison** is only available if the retouch menu is displayed by pressing  and selecting **Retouch** in full-frame playback when a retouched image or original is displayed.

My Menu / Recent Settings

Add items

PLAYBACK MENU	Create a custom menu of up to 20 items selected from the playback, photo shooting, movie shooting, Custom Setting, setup, and retouch menus.
PHOTO SHOOTING MENU	
MOVIE SHOOTING MENU	
CUSTOM SETTING MENU	
SETUP MENU	
RETOUCH MENU	

Remove items

Delete items from My Menu.

Rank items

Rank items in My Menu.

Choose tab

(defaults to **MY MENU**)

MY MENU	Choose the menu displayed in the “My Menu/Recent Settings” tab. Select RECENT SETTINGS to display a menu listing the 20 most recently-used settings.
RECENT SETTINGS	





Technical Notes

Read this chapter for information on compatible accessories, cleaning and storing the camera, and what to do if an error message is displayed or you encounter problems using the camera.

Compatible Lenses

Compatible CPU Lenses

Nikon recommends CPU lenses (IX Nikkor lenses excluded) and in particular type G, E, and D lenses, which support the full range of features offered by the camera.

Camera setting Lens/accessory	Focus mode		Shooting mode		Metering system			
	AF	MF (with electronic rangefinder) ¹	M	Other modes	 ²		 ³  ⁴	 * ⁵
					3D	Color		
Type G, E, or D ⁶ ; AF-S, AF-P, AF-I	✓	✓	✓	✓	✓	—	✓	✓
PC-E NIKKOR series ^{7,8}	—	✓ ⁹	✓	✓	✓	—	✓	✓
PC NIKKOR 19mm f/4E ED ^{8,10}	—	✓ ⁹	✓	✓	✓	—	✓	✓
PC Micro 85mm f/2.8D ¹¹	—	✓ ⁹	✓	—	✓	—	✓	✓
AF-S/AF-I teleconverter	✓ ¹²	✓ ¹²	✓	✓	✓	—	✓	✓
Other AF NIKKOR (except lenses for F3AF)	✓	✓ ¹³	✓	✓	—	✓	✓	—
AI-P NIKKOR	—	✓ ¹⁴	✓	✓	—	✓	✓	—

1 Manual focus is available with all lenses.

2 Matrix.

3 Center-weighted.

4 Spot (meters selected focus point).

5 Highlight-weighted.

- 6 Vibration Reduction (VR) supported with VR lenses.
- 7 The shift knob for the PC-E NIKKOR 24mm f/3.5D ED may contact the camera body when the lens is rotated. In addition, some combinations of shift and rotation may not be available due to the lens contacting the camera body.
- 8 Shifting and/or tilting the lens interferes with exposure.
- 9 Can not be used with shifting or tilting.
- 10 Some combinations of shift and rotation may not be available due to the lens contacting the camera body.
- 11 Optimal exposure will only be achieved if the lens is at maximum aperture and the lens is not shifted or tilted.
- 12 With maximum effective aperture of f/5.6 or faster.
- 13 When AF 80–200mm f/2.8, AF 35–70mm f/2.8, AF 28–85mm f/3.5–4.5 (New), or AF 28–85mm f/3.5–4.5 lenses are zoomed all the way in at the minimum focus distance, the in-focus indicator (●) may be displayed when the image on the matte screen in the viewfinder is not in focus. Before shooting, confirm that the image in the viewfinder screen is in focus.
- 14 With maximum aperture of f/5.6 or faster.

■ Recognizing CPU and Type G, E, and D Lenses

CPU lenses (particularly types G, E, and D) are recommended, but note that IX-NIKKOR lenses can not be used. CPU lenses can be identified by the presence of CPU contacts, type G, E, and D lenses by a letter on the lens barrel. Type G and E lenses are not equipped with a lens aperture ring.

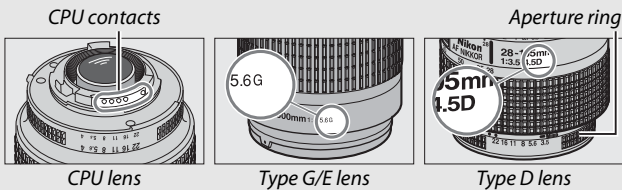

AF-S/AF-I Teleconverters

If the combined aperture when the camera is used with an AF-S/AF-I teleconverter is slower than $f/5.6$ but is equal to or faster than $f/8$, autofocus and electronic rangefinding will be available only with the center focus point and the camera may be unable to focus on dark or low-contrast subjects. Single point AF is used when 3D-tracking or auto-area AF is selected for AF-area mode (📖 103). Autofocus is not available if teleconverters are used with the AF-S VR Micro-Nikkor 105mm $f/2.8G$ IF-ED. If TC-17E II, TC-20E, TC-20E II, or TC-20E III teleconverters are used with the AF-S NIKKOR 300mm $f/4E$ PF ED VR, autofocus is available only in AF-S mode.

Lens f-number

The f-number given in lens names is the maximum aperture of the lens.

Red-Eye Reduction

Lenses that block the subject's view of the red-eye reduction lamp may interfere with red-eye reduction.

VR Lenses

The lenses listed below are not recommended for long exposures or photographs taken at high ISO sensitivities, as due to the design of the vibration reduction (VR) control system the resulting photos may be marred by fog. We recommend turning vibration reduction off when using other VR lenses.

- AF-S VR Zoom-Nikkor 24–120mm f/3.5–5.6G IF-ED
- AF-S VR Zoom-Nikkor 70–200mm f/2.8G IF-ED
- AF-S VR Zoom-Nikkor 70–300mm f/4.5–5.6G IF-ED
- AF-S VR Nikkor 200mm f/2G IF-ED
- AF-S VR Nikkor 300mm f/2.8G IF-ED
- AF-S NIKKOR 16–35mm f/4G ED VR
- AF-S NIKKOR 24–120mm f/4G ED VR
- AF-S NIKKOR 28–300mm f/3.5–5.6G ED VR
- AF-S NIKKOR 400mm f/2.8G ED VR
- AF-S NIKKOR 500mm f/4G ED VR
- AF-S DX VR Zoom-Nikkor 18–200mm f/3.5–5.6G IF-ED
- AF-S DX NIKKOR 16–85mm f/3.5–5.6G ED VR
- AF-S DX NIKKOR 18–200mm f/3.5–5.6G ED VR II
- AF-S DX Micro NIKKOR 85mm f/3.5G ED VR
- AF-S DX NIKKOR 55–300mm f/4.5–5.6G ED VR

AF-Assist Illumination

The AF-assist illuminator has a range of about 0.5–3.0 m (1 ft 8 in.–9 ft 10 in.); when using the illuminator, use a lens with a focal length of 18–200 mm. Some lenses may block the illuminator at certain focus distances. Remove lens hoods when using the illuminator. More information on lenses that can be used with the AF-assist illuminator may be found in the *Menu Guide*, which is available for download from the following website:

<http://downloadcenter.nikonimglib.com/>

The Built-in Flash

The built-in flash has a minimum range of 0.6 m (2 ft) and can not be used in the macro range of macro zoom lenses. It can be used with CPU lenses with focal lengths of 16–300 mm, although in some cases the flash may be unable to entirely light the subject at some ranges or focal lengths due to shadows cast by the lens. The following illustrations show the effect of vignetting caused by shadows cast by the lens when the flash is used. Peripheral illumination may drop at focal lengths under 16 mm.

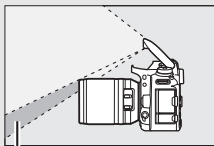

Shadow



Vignetting

Remove lens hoods to prevent shadows. More information on lenses that can be used with the built-in flash may be found in the camera *Menu Guide*, which is available for download from the following website:

<http://downloadcenter.nikonimglib.com/>

Calculating Angle of View

The size of the area exposed by a 35mm camera is 36×24 mm. The size of the area exposed by the D7500 when **DX (24×16)** is selected for **Choose image area** in the photo shooting menu, in contrast, is 23.5×15.7 mm, meaning that the angle of view of a 35mm camera is approximately 1.5 times that of the D7500 (when **1.3× (18×12)** is selected, the size of the area exposed decreases, further reducing the angle of view by about 1.3×).

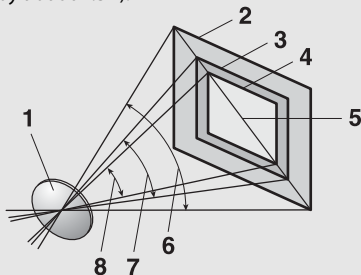

- 1 Lens
- 2 35 mm format picture size (36×24 mm)
- 3 Picture size when **DX (24×16)** is selected for **Choose image area** (23.5×15.7 mm)
- 4 Picture size when **1.3× (18×12)** is selected for **Choose image area** (18.0×12.0 mm)
- 5 Picture diagonal
- 6 35 mm format angle of view
- 7 Angle of view when **DX (24×16)** is selected for **Choose image area**
- 8 Angle of view when **1.3× (18×12)** is selected for **Choose image area**

Compatible Non-CPU Lenses

Non-CPU lenses may only be used when the camera is in mode **M**. Selecting another mode disables the shutter release. Aperture must be adjusted manually via the lens aperture ring and the camera metering system, i-TTL flash control, and other features requiring a CPU lens can not be used. Some non-CPU lenses can not be used; see “Incompatible Accessories and Non-CPU Lenses” (☞ 286).

Camera setting Lens/accessory	Focus mode			Shooting mode	
	AF	MF (with electronic rangefinder)	MF	M	Other modes
AI-, AI-modified NIKKOR or Nikon Series E lenses	—	✓ ¹	✓	✓ ²	—
Medical NIKKOR 120mm f/4	—	✓	✓	✓ ^{2,3}	—
Reflex NIKKOR	—	—	✓	✓ ²	—
PC NIKKOR	—	✓ ⁴	✓	✓ ²	—
AI-type Teleconverter	—	✓ ⁵	✓	✓ ²	—
PB-6 Bellows Focusing Attachment ⁶	—	✓ ¹	✓	✓ ²	—
Auto extension rings (PK-series 11A, 12, or 13; PN-11)	—	✓ ¹	✓	✓ ²	—

1 With maximum aperture of f/5.6 or faster.

2 Exposure indicator can not be used.

3 Can be used at shutter speeds slower than flash sync speed by one step or more.

4 Can not be used with shifting or tilting.

5 With maximum effective aperture of f/5.6 or faster.

6 Attach in vertical orientation (can be used in horizontal orientation once attached).

❑ Incompatible Accessories and Non-CPU Lenses

The following can NOT be used with the D7500:

- TC-16A AF teleconverter
- Non-AI lenses
- Lenses that require the AU-1 focusing unit (400mm f/4.5, 600mm f/5.6, 800mm f/8, 1200mm f/11)
- Fisheye (6mm f/5.6, 7.5mm f/5.6, 8mm f/8, OP 10mm f/5.6)
- 2.1cm f/4
- Extension Ring K2
- 180–600mm f/8 ED (serial numbers 174041–174180)
- 360–1200mm f/11 ED (serial numbers 174031–174127)
- 200–600mm f/9.5 (serial numbers 280001–300490)
- AF lenses for the F3AF (AF 80mm f/2.8, AF 200mm f/3.5 ED, AF Teleconverter TC-16)
- PC 28mm f/4 (serial number 180900 or earlier)
- PC 35mm f/2.8 (serial numbers 851001–906200)
- PC 35mm f/3.5 (old type)
- Reflex 1000mm f/6.3 (old type)
- Reflex 1000mm f/11 (serial numbers 142361–143000)
- Reflex 2000mm f/11 (serial numbers 200111–200310)

Other Accessories

At the time of writing, the following accessories were available for the D7500.

Power sources	<ul style="list-style-type: none">• EN-EL15b/EN-EL15a/EN-EL15 Rechargeable Li-ion Batteries (□ 19, 21); note that fewer pictures can be taken on a single charge with an EN-EL15 than with an EN-EL15b/EN-EL15a (□ 349)• MH-25a Battery Charger (□ 19)• EP-5B Power Connector, EH-5b or EH-5c AC Adapter
Viewfinder eyepiece accessories	<ul style="list-style-type: none">• DK-28 Rubber Eyecup• DK-5 Eyepiece Cap• DK-20C Eyepiece Correction Lenses• DK-21M Magnifying Eyepiece• DG-2 Magnifier (requires DK-22 Eyepiece Adapter)• DR-6 Right-Angle Viewing Attachment
Remote controls/ wireless remote controllers/ remote cords	<ul style="list-style-type: none">• ML-L3 Wireless Remote Control (□ 175)• WR-R10 Wireless Remote Controller/WR-T10 Wireless Remote Controller• WR-1 Wireless Remote Controller• MC-DC2 Remote Cord (□ 79)
GPS units	GP-1 GPS Unit/GP-1A GPS Unit (□ 223); note that production of GP-1/GP-1A units has ended
USB cables	UC-E20 USB Cable
HDMI cables	HC-E1 HDMI Cable
Microphones	<ul style="list-style-type: none">• ME-1 Stereo Microphone• ME-W1 Wireless Microphone
Accessory shoe covers	BS-1 Accessory Shoe Cover
Body cap	BF-1B Body Cap/BF-1A Body Cap
Software	Camera Control Pro 2

Availability may vary with country or region. See our website or brochures for the latest information.

Caring for the Camera

Storage

When the camera will not be used for an extended period, remove the battery and store it in a cool, dry area with the terminal cover in place. To prevent mold or mildew, store the camera in a dry, well-ventilated area. Do not store your camera with naphtha or camphor moth balls or in locations that:

- are poorly ventilated or subject to humidities of over 60%
- are next to equipment that produces strong electromagnetic fields, such as televisions or radios
- are exposed to temperatures above 50 °C (122 °F) or below -10 °C (14 °F)

Cleaning

Camera body	Use a blower to remove dust and lint, then wipe gently with a soft, dry cloth. After using the camera at the beach or seaside, wipe off sand or salt with a cloth lightly dampened in distilled water and dry thoroughly. Important: <i>Dust or other foreign matter inside the camera may cause damage not covered under warranty.</i>
Lens, mirror, and viewfinder	These glass elements are easily damaged. Remove dust and lint with a blower. If using an aerosol blower, keep the can vertical to prevent the discharge of liquid. To remove fingerprints and other stains, apply a small amount of lens cleaner to a soft cloth and clean with care.
Monitor	Remove dust and lint with a blower. When removing fingerprints and other stains, wipe the surface lightly with a soft cloth or chamois leather. Do not apply pressure, as this could result in damage or malfunction.

Do not use alcohol, thinner, or other volatile chemicals.

Image Sensor Cleaning

If you suspect that dirt or dust on the image sensor is appearing in photographs, you can clean the sensor using the **Clean image sensor** option in the setup menu. The sensor can be cleaned at any time using the **Clean now** option, or cleaning can be performed automatically when the camera is turned on or off.

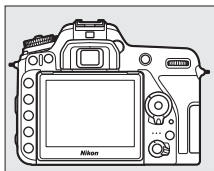

■ ■ “Clean Now”

Holding the camera base down, select **Clean image sensor** in the setup menu, then highlight **Clean now** and press **OK**. The camera will check the image sensor and then begin cleaning. **b u S Y** flashes in the control panel and other operations can not be performed while cleaning is in progress. Do not remove or disconnect the power source until cleaning ends and the setup menu is displayed.





■ “Clean at Startup/Shutdown”

Choose from the following options:

Option	Description
 Clean at startup	The image sensor is automatically cleaned each time the camera is turned on.
 Clean at shutdown	The image sensor is automatically cleaned during shutdown each time the camera is turned off.
 Clean at startup & shutdown	The image sensor is cleaned automatically at startup and at shutdown.
Cleaning off	Automatic image sensor cleaning off.

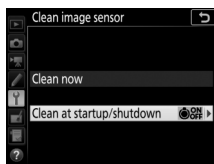
- 1 Select Clean at startup/shutdown.**
Display the **Clean image sensor** menu as described in “Clean Now” (□ 289). Highlight **Clean at startup/shutdown** and press .



- 2 Select an option.**
Highlight an option and press .

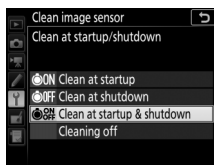

Image Sensor Cleaning

Using camera controls during startup interrupts image sensor cleaning. Image sensor cleaning may not be performed at startup if the flash is charging.

If dust can not be fully removed using the options in the **Clean image sensor** menu, clean the image sensor manually (📖 292) or consult a Nikon-authorized service representative.

If image sensor cleaning is performed several times in succession, image sensor cleaning may be temporarily disabled to protect the camera's internal circuitry. Cleaning can be performed again after a short wait.

Manual Cleaning

If foreign matter can not be removed from the image sensor using the **Clean image sensor** option in the setup menu (☞ 289), the sensor can be cleaned manually as described below. Note, however, that the sensor is extremely delicate and easily damaged. Nikon recommends that the sensor be cleaned only by Nikon-authorized service personnel.

1 Charge the battery or connect an AC adapter.

A reliable power source is required when inspecting or cleaning the image sensor. Turn the camera off and insert a fully-charged battery or connect an optional AC adapter and power connector. The **Lock mirror up for cleaning** option is only available in the setup menu if the camera is not connected to a smart device via Bluetooth and the battery level is over .

2 Remove the lens.

Turn the camera off and remove the lens.

3 Select **Lock mirror up for cleaning**.

Turn the camera on and highlight **Lock mirror up for cleaning** in the setup menu and press .

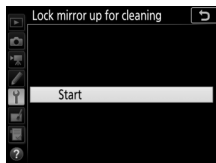

4 Press **OK**.

A message will be displayed in the monitor and a row of dashes will appear in the control panel and viewfinder. To restore normal operation without inspecting the image sensor, turn the camera off.

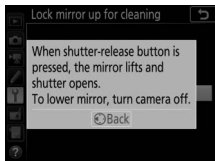

5 Raise the mirror.

Press the shutter-release button all the way down. The mirror will be raised and the shutter curtain will open, revealing the image sensor. The display in the viewfinder will turn off and the row of dashes in the control panel will flash.

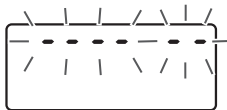

6 Examine the image sensor.

Holding the camera so that light falls on the image sensor, examine the sensor for dust or lint. If no foreign objects are present, proceed to Step 8.

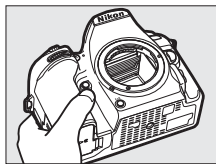

7 Clean the sensor.

Remove any dust and lint from the sensor with a blower. Do not use a blower-brush, as the bristles could damage the sensor. Dirt that can not be removed with a blower can only be removed by Nikon-authorized service personnel. Under no circumstances should you touch or wipe the sensor.



8 Turn the camera off.

The mirror will return to the down position and the shutter curtain will close. Replace the lens or body cap.

Use a Reliable Power Source

The shutter curtain is delicate and easily damaged. If the camera powers off while the mirror is raised, the curtain will close automatically. To prevent damage to the curtain, observe the following precautions:

- Do not turn the camera off or remove or disconnect the power source while the mirror is raised.
- If the battery runs low while the mirror is raised, a beep will sound and the self-timer lamp will flash to warn that the shutter curtain will close and the mirror will be lowered after about two minutes. End cleaning or inspection immediately.

✔ Foreign Matter on the Image Sensor

Foreign matter entering the camera when lenses or body caps are removed or exchanged (or in rare circumstances lubricant or fine particles from the camera itself) may adhere to the image sensor, where it may appear in photographs taken under certain conditions. To protect the camera when no lens is in place, be sure to replace the body cap provided with the camera, being careful to first remove all dust and other foreign matter that may be adhering to the camera mount, lens mount, and body cap. Avoid attaching the body cap or exchanging lenses in dusty environments.

Should foreign matter find its way onto the image sensor, use the image sensor cleaning option as described in “Image Sensor Cleaning” (☞ 289). If the problem persists, clean the sensor manually (☞ 292) or have the sensor cleaned by authorized Nikon service personnel. Photographs affected by the presence of foreign matter on the sensor can be retouched using the clean image options available in some imaging applications.

✔ Servicing the Camera and Accessories

The camera is a precision device and requires regular servicing. Nikon recommends that the camera be inspected by the original retailer or Nikon-authorized service representative once every one to two years, and that it be serviced once every three to five years (note that fees apply to these services). Frequent inspection and servicing are particularly recommended if the camera is used professionally. Any accessories regularly used with the camera, such as lenses or optional flash units, should be included when the camera is inspected or serviced.

Caring for the Camera and Battery: Cautions

Do not drop: The product may malfunction if subjected to strong shocks or vibration.

Keep dry: This product is not waterproof, and may malfunction if immersed in water or exposed to high levels of humidity. Rusting of the internal mechanism can cause irreparable damage.

Avoid sudden changes in temperature: Sudden changes in temperature, such as those that occur when entering or leaving a heated building on a cold day, can cause condensation inside the device. To prevent condensation, place the device in a carrying case or plastic bag before exposing it to sudden changes in temperature.

Keep away from strong magnetic fields: Do not use or store this device in the vicinity of equipment that generates strong electromagnetic radiation or magnetic fields. Static charges or the magnetic fields produced by equipment such as radio transmitters could interfere with the monitor, damage data stored on the memory card, or affect the product's internal circuitry.

Do not leave the lens pointed at the sun: Do not leave the lens pointed at the sun or other strong light source for an extended period. Intense light may cause the image sensor to deteriorate or produce a white blur effect in photographs.

Turn the product off before removing or disconnecting the power source: Do not unplug the product or remove the battery while the product is on or while images are being recorded or deleted. Forcibly cutting power in these circumstances could result in loss of data or in damage to product memory or internal circuitry. To prevent an accidental interruption of power, avoid carrying the product from one location to another while the AC adapter is connected.

Cleaning: When cleaning the camera body, use a blower to gently remove dust and lint, then wipe gently with a soft, dry cloth. After using the camera at the beach or seaside, wipe off any sand or salt using a cloth lightly dampened in pure water and then dry the camera thoroughly. In rare instances, static electricity may cause LCD displays to light up or go dark. This does not indicate a malfunction, and the display will soon return to normal.

The lens and mirror are easily damaged. Dust and lint should be gently removed with a blower. When using an aerosol blower, keep the can vertical to prevent discharge of liquid. To remove fingerprints and other stains from the lens, apply a small amount of lens cleaner to a soft cloth and wipe the lens carefully.

See “Image Sensor Cleaning” (□ 289, 292) for information on cleaning the image sensor.

Lens contacts: Keep the lens contacts clean.

Do not touch the shutter curtain: The shutter curtain is extremely thin and easily damaged. Under no circumstances should you exert pressure on the curtain, poke it with cleaning tools, or subject it to powerful air currents from a blower. These actions could scratch, deform, or tear the curtain.

The shutter curtain may appear to be unevenly colored, but this has no affect on pictures and does not indicate a malfunction.

Storage: To prevent mold or mildew, store the camera in a dry, well-ventilated area. If you are using an AC adapter, unplug the adapter to prevent fire. If the product will not be used for an extended period, remove the battery to prevent leakage and store the camera in a plastic bag containing a desiccant. Do not, however, store the camera case in a plastic bag, as this may cause the material to deteriorate. Note that desiccant gradually loses its capacity to absorb moisture and should be replaced at regular intervals.

To prevent mold or mildew, take the camera out of storage at least once a month. Turn the camera on and release the shutter a few times before putting it away.

Store the battery in a cool, dry place. Replace the terminal cover before putting the battery away.

Notes on the monitor: The monitor is constructed with extremely high precision; at least 99.99% of pixels are effective, with no more than 0.01% being missing or defective. Hence while these displays may contain pixels that are always lit (white, red, blue, or green) or always off (black), this is not a malfunction and has no effect on images recorded with the device.

Images in the monitor may be difficult to see in a bright light.

Do not apply pressure to the monitor, as this could cause damage or malfunction. Dust or lint on the monitor can be removed with a blower. Stains can be removed by wiping lightly with a soft cloth or chamois leather. Should the monitor break, care should be taken to avoid injury from broken glass and to prevent liquid crystal from the monitor touching the skin or entering the eyes and mouth.

The battery and charger: Batteries may leak or explode if improperly handled. Observe the following precautions when handling batteries and chargers:

- Use only batteries approved for use in this equipment.
- Do not expose the battery to flame or excessive heat.
- Keep the battery terminals clean.
- Turn the product off before replacing the battery.
- Remove the battery from the camera or charger when not in use and replace the terminal cover. These devices draw minute amounts of charge even when off and could draw the battery down to the point that it will no longer function. If the battery will not be used for some time, insert it in the camera and run it flat before removing it from the camera for storage. The battery should be stored in a cool location with an ambient temperature of 15 °C to 25 °C (59 °F to 77 °F; avoid hot or extremely cold locations). Repeat this process at least once every six months.
- Turning the camera on or off repeatedly when the battery is fully discharged will shorten battery life. Batteries that have been fully discharged must be charged before use.

- The internal temperature of the battery may rise while the battery is in use. Attempting to charge the battery while the internal temperature is elevated will impair battery performance, and the battery may not charge or charge only partially. Wait for the battery to cool before charging.
- Charge the battery indoors at ambient temperatures of 5 °C–35 °C (41 °F–95 °F). Do not use the battery at ambient temperatures below 0 °C (32 °F) or above 40 °C (104 °F); failure to observe this precaution could damage the battery or impair its performance. Capacity may be reduced and charging times increase at battery temperatures from 0 °C (32 °F) to 15 °C (59 °F) and from 45 °C (113 °F) to 60 °C (140 °F). The battery will not charge if its temperature is below 0 °C (32 °F) or above 60 °C (140 °F).
- If the **CHARGE** lamp flashes quickly (about eight times a second) during charging, confirm that the temperature is in the correct range and then unplug the charger and remove and reinsert the battery. If the problem persists, cease use immediately and take battery and charger to your retailer or a Nikon-authorized service representative.
- Do not move the charger or touch the battery during charging. Failure to observe this precaution could in very rare instances result in the charger showing that charging is complete when the battery is only partially charged. Remove and reinsert the battery to begin charging again.
- Battery capacity may temporarily drop if the battery is charged at low temperatures or used at a temperature below the temperature at which it was charged. If the battery is charged at a temperature below 5 °C (41 °F), the battery life indicator in the **Battery info** (□ 273) display may show a temporary decrease.
- Continuing to charge the battery after it is fully charged can impair battery performance.

- A marked drop in the time a fully charged battery retains its charge when used at room temperature indicates that it requires replacement. Purchase a new battery.
- The supplied power cable and AC wall adapter are for use with the MH-25a only. Use the charger with compatible batteries only. Unplug when not in use.
- Do not short the charger terminals. Failure to observe this precaution could result in overheating and damage to the charger.
- Charge the battery before use. When taking photographs on important occasions, ready a spare battery and keep it fully charged. Depending on your location, it may be difficult to purchase replacement batteries on short notice. Note that on cold days, the capacity of batteries tends to decrease. Be sure the battery is fully charged before taking photographs outside in cold weather. Keep a spare battery in a warm place and exchange the two as necessary. Once warmed, a cold battery may recover some of its charge.
- Used batteries are a valuable resource; recycle in accord with local regulations.

Troubleshooting

If the camera fails to function as expected, check the list of common problems below before consulting your retailer or Nikon-authorized service representative.

Battery/Display

The camera is on but does not respond: Wait for recording to end. If the problem persists, turn the camera off. If the camera does not turn off, remove and reinsert the battery or, if you are using an AC adapter, disconnect and reconnect the AC adapter. Note that although any data currently being recorded will be lost, data that have already been recorded will not be affected by removing or disconnecting the power source.

Viewfinder is out of focus: Adjust viewfinder focus (☐ 11). If this does not correct the problem, select single-servo autofocus (**AF-S**; ☐ 100), single-point AF (☐ 103), and the center focus point (☐ 110), and then frame a high-contrast subject in the center focus point and press the shutter-release button halfway to focus the camera. With the camera in focus, use the diopter adjustment control to bring the subject into clear focus in the viewfinder. If necessary, viewfinder focus can be further adjusted using optional corrective lenses (☐ 287).

Viewfinder is dark: Insert a fully-charged battery (☐ 19, 46).

Displays turn off without warning: Choose longer delays for Custom Setting c2 (**Standby timer**) or c4 (**Monitor off delay**; ☐ 263).

Displays in control panel or viewfinder are unresponsive and dim: The response times and brightness of these displays vary with temperature.

The viewfinder display turns red when a focus point is highlighted: This is normal for this type of viewfinder and does not indicate a malfunction.

Shooting (All Modes)

Camera takes time to turn on: Delete files or folders.

Shutter-release disabled:

- Memory card is locked, full, or not inserted (☐ 21, 22).
 - **Release locked** is selected for **Slot empty release lock** in the setup menu (☐ 273) and no memory card is inserted (☐ 21).
 - Built-in flash is charging (☐ 55).
 - Aperture ring for CPU lens not locked at highest f-number (does not apply to type G and E lenses).
 - Non-CPU lens is attached but camera is not in mode **M** (☐ 72).
-

Camera is slow to respond to shutter-release button: Select **Off** for Custom Setting d3 (**Exposure delay mode**; ☐ 264).

No photo taken when remote control shutter-release button is pressed:

- Replace battery in remote control.
 - Choose an option other than **Off** for **Remote control mode (ML-L3)** (☐ 175).
 - Flash is charging (☐ 177).
 - Time selected for Custom Setting c5 (**Remote on duration (ML-L3)**, ☐ 263) has elapsed.
 - Bright light is interfering with remote.
-

Only one shot taken each time shutter-release button is pressed in continuous release mode: Continuous shooting is not available when built-in flash fires (☐ 163) or with HDR (high dynamic range; ☐ 155).

Photos are out of focus:

- Rotate focus-mode selector to **AF** (☐ 100).
 - Camera unable to focus using autofocus: use manual focus or focus lock (☐ 111, 115).
-

Beep does not sound:

- **Off** is selected for **Beep options > Beep on/off** (☐ 271).
 - **AF-C** is selected as the focus mode or subject moves when **AF-A** is selected (☐ 100).
-

Focus does not lock when shutter-release button is pressed halfway: Use ^{AE-L}_{AF-L} **AE-L/AF-L** button to lock focus when **AF-C** is selected for focus mode or when photographing moving subjects in **AF-A** mode.

Can not select focus point:

- Unlock focus selector lock (☞ 107).
 - Auto-area AF selected, or face-priority AF selected in live view; choose another mode (☞ 103).
 - Camera is in playback mode (☞ 225) or menus are in use (☞ 250).
 - Press shutter-release button halfway to start standby timer (☞ 54).
-

Can not select AF mode: Manual focus selected (☞ 100, 115).

Can not select AF-area mode: Manual focus selected (☞ 100, 115).

Image size can not be changed: **Image quality** set to **NEF (RAW)** (☞ 97).

Camera is slow to record photos: Turn long exposure noise reduction off (☞ 255).

AF-assist illuminator does not light:

- AF-assist illuminator does not light if **AF-C** is selected for autofocus mode (☞ 100) or if continuous-servo autofocus is selected when the camera is in **AF-A** mode. Choose **AF-S**. If an option other than auto-area AF is selected for AF-area mode, select center focus point (☞ 110).
 - The camera is currently in live view.
 - **Off** is selected for Custom Setting a9 (**Built-in AF-assist illuminator**, ☞ 261).
 - Illuminator has turned off automatically. Illuminator may become hot with continued use; wait for it to cool down.
-

Smudges appear in photographs: Clean front and rear lens elements. If problem persists, perform image sensor cleaning (☞ 289).

Noise (bright spots, randomly-spaced bright pixels, fog, or lines) appear in photos:

- Bright spots, randomly-spaced bright pixels, fog, and lines can be reduced by lowering ISO sensitivity.
- Use the **Long exposure NR** option in the photo shooting menu to limit the occurrence of bright spots or fog in photos taken at shutter speeds slower than 1 s (☐ 255).
- Fog and bright spots may indicate that the camera's internal temperature has become elevated due to high ambient temperatures, long exposures, or similar causes: turn the camera off and wait for it to cool before resuming shooting.
- At high ISO sensitivities, lines may appear in photos taken with some optional flash units; if this occurs, choose a lower value.
- At high ISO sensitivities, including high values selected with auto ISO sensitivity control, randomly-spaced bright pixels can be reduced by selecting **High, Normal**, or **Low** for **High ISO NR** in the photo or movie shooting menu (☐ 255, 259).
- At high ISO sensitivities, bright spots, randomly-spaced bright pixels, fog, or lines may be more noticeable in long exposures, multiple exposures, and photos taken at high ambient temperatures or with Active D-Lighting enabled, **Flat** selected for **Set Picture Control** (☐ 148) or extreme values selected for Picture Control parameters (☐ 151).
- In  mode, randomly-spaced bright pixels, fog, or lines may be more noticeable in pictures shot under low light.

Flicker or banding appears in movie mode: Select **Flicker reduction** in the movie shooting menu and choose an option that matches the frequency of the local AC power supply (☐ 259).

Bright regions or bands appear in live view: A flashing sign, flash, or other light source with brief duration was used during live view.

Sound is not recorded with movies: **Microphone off** is selected for **Microphone sensitivity** in the movie shooting menu (☐ 259).

Live view ends unexpectedly or does not start: Live view may end automatically to prevent damage to the camera's internal circuits if:

- The ambient temperature is high
- The camera has been used for extended periods in live view or to record movies
- The camera has been used in continuous release modes for extended periods





If live view does not start when you press the  button, wait for the internal circuits to cool and then try again. Note that the camera may feel warm to the touch, but this does not indicate a malfunction.

Image artifacts appear during live view: "Noise" (randomly-spaced bright pixels, fog, or lines) and unexpected colors may appear if you zoom in on the view through the lens ( 57) during live view; in movies, the amount and distribution of randomly-spaced bright pixels, fog, and bright spots is affected by frame size and rate ( 188). Randomly-spaced bright pixels, fog, or bright spots may also arise as a result of increases in the temperature of the camera's internal circuits during live view; exit live view when the camera is not in use.

Menu item can not be selected: Some options are not available in all modes.

Shooting (P, S, A, M)

Shutter-release disabled:

- Non-CPU lens is attached: rotate camera mode dial to **M** ( 72).
 - Mode dial rotated to **S** after shutter speed of **bu** **l** **b** or **-** selected in mode **M**: choose new shutter speed ( 74).
-

Full range of shutter speeds not available: Flash in use. Flash sync speed can be selected using Custom Setting e1 (**Flash sync speed**); when using compatible flash units, choose **1/320 s (Auto FP)** or **1/250 s (Auto FP)** for full range of shutter speeds ( 265).

Can not measure white balance: Subject is too dark or too bright ( 142).

Image can not be selected as source for preset white balance: Image was not created with D7500 ( 146).

White balance bracketing unavailable:

- NEF (RAW) or NEF+JPEG image quality option selected for image quality (☞ 97).
- Multiple exposure mode is in effect (☞ 256).

Effects of Picture Control differ from image to image: **Auto** is selected for **Set Picture Control**, a Picture Control based on **Auto** is selected, or **A** (auto) is selected for sharpening, clarity, contrast, or saturation. For consistent results over a series of photos, choose another setting (☞ 151).

Metering can not be changed: Autoexposure lock is in effect (☞ 125).

Exposure compensation can not be used: Camera is in mode **M**. Choose another mode.

Noise (reddish areas or other artifacts) appears in long time-exposures: Enable long exposure noise reduction (☞ 255).

Playback

NEF (RAW) image is not played back: Photo was taken at image quality of NEF + JPEG (☞ 97).

Can not view pictures recorded with other cameras: Pictures recorded with other makes of camera may not be displayed correctly.

Some photos are not displayed during playback: Select **All** for **Playback folder** (☞ 250).

The camera displays a message stating that the folder contains no images: Select **All** for **Playback folder** (☞ 250).

“Tall” (portrait) orientation photos are displayed in “wide” (landscape) orientation:

- Photo was taken with **Off** selected for **Auto image rotation** (☞ 251).
- Select **On** for **Rotate tall** (☞ 251).
- Photo is displayed in image review (☞ 227).
- Camera was pointed up or down when photo was taken.

Can not delete picture:

- Picture is protected: remove protection (☞ 242).
 - Memory card is locked (☞ 22).
-

Can not retouch picture: Photo can not be further edited with this camera.

Can not select photo for printing: Photo is in NEF (RAW) format. Transfer photos to computer and print using Capture NX-D (□ iv). NEF (RAW) photos can be saved in JPEG format using **NEF (RAW) processing** (□ 275).

Photo is not displayed on high-definition video device: Confirm that HDMI cable (available separately) is connected.

Can not transfer photos to computer: OS not compatible with camera or transfer software. Use card reader to copy photos to computer.

Image Dust Off option in Capture NX-D does not have desired effect: Image sensor cleaning changes the position of dust on the image sensor. Dust off reference data recorded before image sensor cleaning is performed can not be used with photographs taken after image sensor cleaning is performed. Dust off reference data recorded after image sensor cleaning is performed can not be used with photographs taken before image sensor cleaning is performed.

Computer displays NEF (RAW) images differently from camera: Third-party software does not display effects of Picture Controls, Active D-Lighting, or vignette control. Use Capture NX-D (□ iv).

Bluetooth and Wi-Fi (Wireless Networks)

Smart devices do not display the camera SSID (network name):

- Confirm that **Disable** is selected for **Airplane mode** in the camera setup menu (☐ 272).
 - Confirm that **Enable** is selected for **Bluetooth > Network connection** in the camera setup menu.
 - Try turning the smart device Wi-Fi off and then on again.
-

Can not connect to wireless printers and other wireless devices: This camera can connect only to devices to which the SnapBridge app has been installed.

Miscellaneous

Date of recording is not correct: The camera clock is less accurate than most watches and household clocks. Check the clock regularly against more accurate timepieces and reset as necessary.

Menu item can not be selected: Some options are not available at certain combinations of settings or when no memory card is inserted. Note that **Battery info** option is not available when camera is powered by an optional power connector and AC adapter.

Error Messages

This section lists the indicators and error messages that appear in the viewfinder, control panel, and monitor.

Indicator		Problem	Solution
Control panel	Viewfinder		
		Lens aperture ring is not set to minimum aperture.	Set ring to minimum aperture (highest f-number; □ 72).
		Low battery.	Ready a fully-charged spare battery (□ 19).
		<ul style="list-style-type: none"> Battery exhausted. Battery can not be used. An extremely exhausted rechargeable Li-ion battery or a third-party battery is inserted in the camera. High battery temperature. 	<ul style="list-style-type: none"> Recharge or replace battery (□ 19, 21, 287). Contact Nikon-authorized service representative. Replace the battery, or recharge the battery if the rechargeable Li-ion battery is exhausted. Remove battery and wait for it to cool.
		<ul style="list-style-type: none"> No lens attached. Non-CPU lens attached. 	<ul style="list-style-type: none"> Attach a CPU lens. If a CPU lens is already attached, remove and reattach the lens (□ 24, 279). Select mode M (□ 72).
—		Camera unable to focus using autofocus.	Change composition or focus manually (□ 114, 115).

Indicator		Problem	Solution
Control panel	View-finder		
(Exposure indicators and shutter speed or aperture display flash)		Subject too bright; photo will be overexposed.	<ul style="list-style-type: none"> • Use a lower ISO sensitivity (□ 118). • In shooting mode: <ul style="list-style-type: none"> P Use a third-party ND filter S Increase shutter speed (□ 74) A Choose a smaller aperture (higher f-number; □ 75) ☑ Choose another shooting mode (□ 6)
		Subject too dark; photo will be underexposed.	<ul style="list-style-type: none"> • Use a higher ISO sensitivity (□ 118). • In shooting mode: <ul style="list-style-type: none"> P Use flash (□ 161) S Lower shutter speed (□ 74) A Choose a larger aperture (lower f-number; □ 75)
bulb (flashes)		bulb selected in mode S .	Change shutter speed or select mode M (□ 74, 76).
- - (flashes)		- - selected in mode S .	Change shutter speed or select mode M (□ 74, 76).
buzz (flashes)	buzz (flashes)	Processing in progress.	Wait until processing is complete.

Indicator		Problem	Solution
Control panel	Viewfinder		
—	⚡ (flashes)	If indicator flashes for 3s after flash fires, photo may be underexposed.	Check photo in monitor; if underexposed, adjust settings and try again (☞ 225).
F u l l (flashes)	F u l (flashes)	Memory insufficient to record further photos at current settings, or camera has run out of file or folder numbers.	<ul style="list-style-type: none"> • Reduce quality or size (☞ 97, 99). • Delete photographs after copying important images to computer or other device (☞ 247). • Insert new memory card (☞ 21).
E r r (flashes)		Camera malfunction.	Release shutter. If error persists or appears frequently, consult Nikon-authorized service representative.

Indicator		Problem	Solution
Monitor	Control panel		
No memory card.	[- E -]	Camera cannot detect memory card.	Turn camera off and confirm that card is correctly inserted (□ 21).
Cannot access this memory card. Insert another card.	[Card, Err (flashes)	<ul style="list-style-type: none"> • Error accessing memory card. • Unable to create new folder. 	<ul style="list-style-type: none"> • Use Nikon-approved card (□ 346). • If error persists after card has been repeatedly ejected and reinserted, card may be damaged. Contact retailer or Nikon-authorized service representative. • Delete files or insert new memory card after copying important images to computer or other device (□ 21, 247).
	[Card, Err (flashes)	Camera can not control Eye-Fi card.	<ul style="list-style-type: none"> • Check that Eye-Fi card firmware is up to date. • Copy files on Eye-Fi card to a computer or other device and format card, or insert new card (□ 21).
Memory card is locked. Slide lock to “write” position.	[Card, - - - (flashes)	Memory card is locked (write protected).	Slide card write-protect switch to “write” position (□ 22).
Not available if Eye-Fi card is locked.	[Card, Err (flashes)	Eye-Fi card is locked (write protected).	

Indicator		Problem	Solution
Monitor	Control panel		
This card is not formatted. Format the card.	[F a r] (flashes)	Memory card has not been formatted for use in camera.	Format memory card or insert new memory card (□ 21, 268).
The clock is not set.	—	Camera clock is not set.	Set camera clock (□ 268).
Unable to start live view. Please wait.	—	The internal temperature of the camera is high.	Wait for the internal circuits to cool before resuming live view photography or movie recording.
Folder contains no images.	—	No images on memory card or in folder(s) selected for playback.	Select folder containing images from Playback folder menu or insert memory card containing images (□ 21, 250).
All images are hidden.	—	All photos in current folder are hidden.	No images can be played back until another folder has been selected or Hide image used to allow at least one image to be displayed (□ 250).
Cannot display this file.	—	File has been created or modified using another device or different make of camera, or file is corrupt.	File can not be played back on camera.

Indicator		Problem	Solution
Monitor	Control panel		
Cannot select this file.	—	Selected image can not be retouched.	Images created with other devices can not be retouched.
This movie cannot be edited.	—	The selected movie can not be edited.	<ul style="list-style-type: none"> • Movies created with other devices can not be edited. • Movies must be at least two seconds long (☐ 196).
Check printer.	—	Printer error.	Check printer. To resume, select Continue (if available)*.
Check paper.	—	Paper in printer is not of selected size.	Insert paper of correct size and select Continue *.
Paper jam.	—	Paper is jammed in printer.	Clear jam and select Continue *.
Out of paper.	—	Printer is out of paper.	Insert paper of selected size and select Continue *.
Check ink supply.	—	Ink error.	Check ink. To resume, select Continue *.
Out of ink.	—	Printer is out of ink.	Replace ink and select Continue *.

* See printer manual for more information.

Specifications

■ Nikon D7500 Digital Camera

Type	
Type	Single-lens reflex digital camera
Lens mount	Nikon F mount (with AF coupling and AF contacts)
Effective angle of view	Nikon DX format; focal length in 35 mm [135] format equivalent to approx. 1.5× that of lenses with FX format angle of view
Effective pixels	
Effective pixels	20.9 million
Image sensor	
Image sensor	23.5 × 15.7 mm CMOS sensor
Total pixels	21.51 million
Dust-reduction System	Image sensor cleaning, Image Dust Off reference data (Capture NX-D software required)
Storage	
Image size (pixels)	<ul style="list-style-type: none">• DX (24×16) image area 5568 × 3712 (Large: 20.7 M) 4176 × 2784 (Medium: 11.6 M) 2784 × 1856 (Small: 5.2 M)• 1.3× (18×12) image area 4272 × 2848 (Large: 12.2 M) 3200 × 2136 (Medium: 6.8 M) 2128 × 1424 (Small: 3.0 M)• Photographs with image area of DX taken during movie recording 5568 × 3128 (Large) 4176 × 2344 (Medium) 2784 × 1560 (Small)



Storage	
Image size (pixels)	<ul style="list-style-type: none"> • Photographs with image area of 1.3× taken during movie recording 4272 × 2400 (Large) 3200 × 1800 (Medium) 2128 × 1192 (Small) • Photographs taken during movie recording at a frame size of 3840 × 2160: 3840 × 2160
File format	<ul style="list-style-type: none"> • NEF (RAW): 12 or 14 bit, lossless compressed or compressed • JPEG: JPEG-Baseline compliant with fine (approx. 1 : 4), normal (approx. 1 : 8), or basic (approx. 1 : 16) compression; optimal quality compression available • NEF (RAW) + JPEG: Single photograph recorded in both NEF (RAW) and JPEG formats
Picture Control System	Auto, Standard, Neutral, Vivid, Monochrome, Portrait, Landscape, Flat; selected Picture Control can be modified; storage for custom Picture Controls
Media	SD (Secure Digital) and UHS-I compliant SDHC and SDXC memory cards
File system	DCF 2.0, Exif 2.31, PictBridge
Viewfinder	
Viewfinder	Eye-level pentaprism single-lens reflex viewfinder
Frame coverage	<ul style="list-style-type: none"> • DX (24×16) image area: Approx. 100% horizontal and 100% vertical • 1.3× (18×12) image area: Approx. 97% horizontal and 97% vertical
Magnification	Approx. 0.94 × (50 mm f/1.4 lens at infinity, -1.0 m ⁻¹)
Eyepoint	18.5 mm (-1.0 m ⁻¹ ; from center surface of viewfinder eyepiece lens)
Diopter adjustment	-2 - +1 m ⁻¹
Focusing screen	Type B BriteView Clear Matte Mark II screen with AF area brackets (framing grid can be displayed)

Viewfinder	
Reflex mirror	Quick return
Lens aperture	Instant return, electronically controlled
Lens	
Compatible lenses	<p>Compatible with AF NIKKOR lenses, including type G, E, and D lenses (some restrictions apply to PC lenses) and AI-P NIKKOR lenses and non-CPU AI lenses (M mode only). IX NIKKOR lenses, lenses for the F3AF, and non-AI lenses can not be used.</p> <p>The electronic rangefinder can be used with lenses that have a maximum aperture of f/5.6 or faster (the electronic rangefinder supports the center 1 focus point with lenses that have a maximum aperture of f/8 or faster).</p>
Shutter	
Type	Electronically-controlled vertical-travel focal-plane mechanical shutter; electronic front-curtain shutter available in mirror up release mode
Speed	$\frac{1}{8000}$ –30 s in steps of $\frac{1}{3}$ or $\frac{1}{2}$ EV, bulb, time, X250
Flash sync speed	X = $\frac{1}{250}$ s; synchronizes with shutter at $\frac{1}{320}$ s or slower (flash range drops at speeds between $\frac{1}{250}$ and $\frac{1}{320}$ s)
Release	
Release mode	S (single frame), CL (continuous low speed), CH (continuous high speed), Q (quiet shutter-release), QC (quiet continuous shutter-release), ⌚ (self-timer), MUP (mirror up)
Approximate frame advance rate	<ul style="list-style-type: none"> • CL: 1–7 fps • CH: 8 fps <p>Note: Frame rates assume continuous-servo AF, manual or shutter-priority auto exposure, a shutter speed of $\frac{1}{250}$ s or faster, Release selected for Custom Setting a1 (AF-C priority selection), and other settings at default values.</p>

Release	
Self-timer	2 s, 5 s, 10 s, 20 s; 1–9 exposures at intervals of 0.5, 1, 2, or 3 s
Remote control modes (ML-L3)	Delayed remote, quick-response remote, remote mirror-up
Exposure	
Metering system	TTL exposure metering using RGB sensor with approximately 180K (180,000) pixels
Metering mode	<ul style="list-style-type: none"> • Matrix: 3D color matrix metering III (type G, E, and D lenses); color matrix metering III (other CPU lenses) • Center-weighted: Weight of approximately 75% given to 8 mm circle in center of frame. Diameter of circle can be changed to 6, 10, or 13 mm, or weighting can be based on average of entire frame • Spot: Meters circle with diameter of about 3.5 mm (about 2.5% of frame) centered on selected focus point • Highlight-weighted: Available with type G, E, and D lenses
Range (ISO 100, f/1.4 lens, 20 °C/68 °F)	<ul style="list-style-type: none"> • Matrix, center-weighted, or highlight-weighted metering: 0–20 EV • Spot metering: 2–20 EV
Exposure meter coupling	CPU
Mode	Auto modes (📷 auto; 📷 auto, flash off); scene modes (👤 portrait; 🏞 landscape; 👦 child; 🏃 sports; 📷 close up; 🌃 night portrait; 🌃 night landscape; 🎉 party/indoor; 🏖 beach/snow; 🌅 sunset; 🌅 dusk/dawn; 🐾 pet portrait; 🕯 candlelight; 🌸 blossom; 🍂 autumn colors; 🍽 food); special effects modes (🌃 night vision; 🌈 super vivid; 📢 pop; 📷 photo illustration; 📷 toy camera effect; 📷 miniature effect; 🖌 selective color; 🖌 silhouette; 📷 high key; 📷 low key); programmed auto with flexible program (P); shutter-priority auto (S); aperture-priority auto (A); manual (M); U1 (user settings 1); U2 (user settings 2)

Exposure	
Exposure compensation	Can be adjusted by -5 – +5 EV in increments of 1/3 or 1/2 EV in P, S, A, M, SCENE , and EFFECTS modes
Exposure lock	Luminosity locked at detected value
ISO sensitivity (Recommended Exposure Index)	ISO 100–51200 in steps of 1/3 or 1/2 EV. Can also be set to approx. 0.3, 0.5, 0.7, or 1 EV (ISO 50 equivalent) below ISO 100 or to approx. 0.3, 0.5, 0.7, 1, 2, 3, 4, or 5 EV (ISO 1640000 equivalent) above ISO 51200; auto ISO sensitivity control available
Active D-Lighting	Can be selected from Auto, Extra high, High, Normal, Low, or Off
Focus	
Autofocus	Nikon Advanced Multi-CAM 3500 II autofocus sensor module with TTL phase detection, fine-tuning, 51 focus points (including 15 cross-type sensors; f/8 supported by 1 sensor), and AF-assist illuminator (range approx. 0.5–3 m/1 ft 8 in.–9 ft 10 in.)
Detection range	-3 – +19 EV (ISO 100, 20 °C/68 °F)
Lens servo	<ul style="list-style-type: none"> • Autofocus (AF): Single-servo AF (AF-S); continuous-servo AF (AF-C); auto AF-S/AF-C selection (AF-A); predictive focus tracking activated automatically according to subject status • Manual focus (M): Electronic rangefinder can be used
Focus point	Can be selected from 51 or 11 focus points
AF-area mode	Single-point AF; 9-, 21-, or 51-point dynamic-area AF, 3D-tracking, group-area AF, auto-area AF
Focus lock	Focus can be locked by pressing shutter-release button halfway (single-servo AF) or by pressing  AE-L/AF-L button

Flash	
Built-in flash	 : Auto flash with auto pop-up P, S, A, M, 11 : Manual pop-up with button release
Guide Number	Approx. 12/39, 12/39 with manual flash (m/ft, ISO 100, 20 °C/68 °F)
Flash control	TTL : i-TTL flash control using RGB sensor with approximately 180K (180,000) pixels is available with built-in flash; i-TTL balanced fill-flash for digital SLR is used with matrix, center-weighted, and highlight-weighted metering, standard i-TTL fill-flash for digital SLR with spot metering
Flash mode	Auto, auto with red-eye reduction, auto slow sync, auto slow sync with red-eye reduction, fill-flash, red-eye reduction, slow sync, slow sync with red-eye reduction, rear-curtain with slow sync, rear-curtain sync, off; Auto FP High-Speed Sync supported
Flash compensation	-3 – +1 EV in increments of 1/3 or 1/2 EV
Flash-ready indicator	Lights when built-in flash or optional flash unit is fully charged; flashes after flash is fired at full output
Accessory shoe	ISO 518 hot-shoe with sync and data contacts and safety lock
Nikon Creative Lighting System (CLS)	i-TTL flash control, radio-controlled Advanced Wireless Lighting, optical Advanced Wireless Lighting, modeling illumination, FV lock, Color Information Communication, Auto FP High-Speed Sync, AF-assist for multi-area AF
Sync terminal	AS-15 sync terminal adapter (available separately)

White balance	
White balance	Auto (2 types), incandescent, fluorescent (7 types), direct sunlight, flash, cloudy, shade, preset manual (up to 6 values can be stored, spot white balance measurement available during live view), choose color temperature (2500 K–10,000 K), all with fine-tuning
Bracketing	
Bracketing types	Exposure, flash, white balance, and ADL
Live view	
Modes	 (photo live view),  (movie live view)
Lens servo	<ul style="list-style-type: none"> • Autofocus (AF): Single-servo AF (AF-S); full-time servo AF (AF-F) • Manual focus (M)
AF-area mode	Face-priority AF, wide-area AF, normal-area AF, subject-tracking AF
Autofocus	Contrast-detect AF anywhere in frame (camera selects focus point automatically when face-priority AF or subject-tracking AF is selected)
Movie	
Metering system	TTL exposure metering using main image sensor
Metering mode	Matrix, center-weighted, or highlight-weighted
Frame size (pixels) and frame rate	<ul style="list-style-type: none"> • 3840 × 2160 (4K UHD); 30p (progressive), 25p, 24p • 1920 × 1080; 60p, 50p, 30p, 25p, 24p • 1280 × 720; 60p, 50p <p>Actual frame rates for 60p, 50p, 30p, 25p, and 24p are 59.94, 50, 29.97, 25, and 23.976 fps respectively; ★ high quality available at all frame sizes, normal quality available at all sizes except 3840 × 2160</p>
File format	MOV, MP4
Video compression	H.264/MPEG-4 Advanced Video Coding

Movie	
Audio recording format	Linear PCM, AAC
Audio recording device	Built-in stereo or external microphone; sensitivity adjustable
ISO sensitivity (Recommended Exposure Index)	<ul style="list-style-type: none"> • Mode M: Auto ISO sensitivity control (ISO 100 to Hi 5) available with selectable upper limit; manual selection (ISO 100 to 51200 in steps of $\frac{1}{3}$ or $\frac{1}{2}$ EV) with additional options available equivalent to approximately 0.3, 0.5, 0.7, 1, 2, 3, 4, or 5 EV (ISO 1640000 equivalent) above ISO 51200 • Modes P, S, and A: Auto ISO sensitivity control (ISO 100 to Hi 5) with selectable upper limit •  (EFFECT) mode: Auto ISO sensitivity control (ISO 100 to Hi 5) • Other modes: Auto ISO sensitivity control (ISO 100 to 12800)
Active D-Lighting	Can be selected from Same as photo settings, Extra high, High, Normal, Low, or Off
Other options	Index marking, time-lapse movies, electronic vibration reduction
Monitor	
Monitor	8-cm/3.2-in., approx. 922k-dot (VGA) tilting TFT touch-sensitive LCD with 170° viewing angle, approximately 100% frame coverage, manual monitor brightness control, and an eye-sensor controlling display on/off
Playback	
Playback	Full-frame and thumbnail (4, 9, or 72 images or calendar) playback with playback zoom, playback zoom cropping, movie playback, photo and/or movie slide shows, histogram display, highlights, photo information, location data display, picture rating, and auto image rotation

Interface	
USB	Hi-Speed USB with Micro-B connector; connection to built-in USB port is recommended
HDMI output	Type C HDMI connector
Accessory terminal	Can be used with MC-DC2 and other optional accessories
Audio input	Stereo mini-pin jack (3.5 mm diameter; plug-in power supported)
Audio output	Stereo mini-pin jack (3.5 mm diameter)
Wireless/Bluetooth	
Wireless	<ul style="list-style-type: none"> • Standards: IEEE 802.11b, IEEE 802.11g • Operating frequency: 2412–2462 MHz (channels 1–11) • Maximum output power: 8.4 dBm (EIRP) • Authentication: Open system, WPA2-PSK
Bluetooth	<ul style="list-style-type: none"> • Communication protocols: Bluetooth Specification Version 4.1 • Operating frequency Bluetooth: 2402–2480 MHz Bluetooth Low Energy: 2402–2480 MHz • Maximum output power (EIRP) Bluetooth: 6.4 dBm Bluetooth Low Energy: 6.4 dBm
Range (line of sight)	Approximately 10 m (32 ft) without interference; range may vary with signal strength and presence or absence of obstacles
Supported languages	
Supported languages	Arabic, Bengali, Bulgarian, Chinese (Simplified and Traditional), Czech, Danish, Dutch, English, Finnish, French, German, Greek, Hindi, Hungarian, Indonesian, Italian, Japanese, Korean, Marathi, Norwegian, Persian, Polish, Portuguese (Portugal and Brazil), Romanian, Russian, Serbian, Spanish, Swedish, Tamil, Telugu, Thai, Turkish, Ukrainian, Vietnamese

Power source	
Battery	One EN-EL15a rechargeable Li-ion battery; EN-EL15b/EN-EL15 can also be used, but note that fewer pictures may sometimes be taken on a single charge with an EN-EL15 than with an EN-EL15b/EN-EL15a (□ 349)
AC adapter	EH-5b/EH-5c AC adapter; requires EP-5B power connector (available separately)

Tripod socket	
Tripod socket	1/4 in. (ISO 1222)

Dimensions/weight	
Dimensions (W × H × D)	Approx. 135.5 × 104 × 72.5 mm (5.4 × 4.1 × 2.9 in.)
Weight	Approx. 720 g (1 lb 9.4 oz) with battery and memory card but without body cap; approx. 640 g (1 lb 6.6 oz; camera body only)

Operating environment	
Temperature	0 °C–40 °C (+32 °F–104 °F)
Humidity	85% or less (no condensation)

- Unless otherwise stated, all measurements are performed in conformity with Camera and Imaging Products Association (CIPA) standards or guidelines.
- All figures are for a camera with a fully-charged battery.
- Nikon reserves the right to change the appearance and specifications of the hardware and software described in this manual at any time and without prior notice. Nikon will not be held liable for damages that may result from any mistakes that this manual may contain.

■ ■ *MH-25a Battery Charger*

Rated input (in North America)	AC 120 V, 60 Hz, 0.2 A
Rated input (in other regions)	AC 100–240 V, 50/60 Hz, 0.23–0.12 A
Rated output	DC 8.4 V/1.2 A
Supported batteries	Nikon EN-EL15b/EN-EL15a/EN-EL15 rechargeable Li-ion batteries
Charging time	Approx. 2 hours and 35 minutes at an ambient temperature of 25 °C (77 °F) when no charge remains
Operating temperature	0 °C–40 °C (+32 °F–104 °F)
Dimensions (W × H × D)	Approx. 95 × 33.5 × 71 mm (3.7 × 1.3 × 2.8 in.), excluding projections
Length of power cable (if supplied)	Approx. 1.5 m (4.9 ft)
Weight	Approx. 115 g (4.1 oz), excluding supplied power connector (power cable or AC wall adapter)

The symbols on this product represent the following:

~ AC, --- DC,  Class II equipment (The construction of the product is double-insulated.)

■ ■ *EN-EL15a Rechargeable Li-ion Battery*

Type	Rechargeable lithium-ion battery
Rated capacity	7.0 V/1900 mAh
Operating temperature	0 °C–40 °C (+32 °F–104 °F)
Dimensions (W × H × D)	Approx. 40 × 56 × 20.5 mm (1.6 × 2.2 × 0.8 in.)
Weight	Approx. 78 g (2.8 oz), excluding terminal cover

Supported Standards

- **DCF Version 2.0:** The **D**esign **R**ule for **C**amera **F**ile **S**ystems (DCF) is a standard widely used in the digital camera industry to ensure compatibility among different makes of camera.
- **Exif version 2.31:** The camera supports Exif (**E**xchangeable **I**mage **F**ile **F**ormat for **D**igital **S**till **C**ameras) version 2.31, a standard in which information stored with photographs is used for optimal color reproduction when the images are output on Exif-compliant printers.
- **PictBridge:** A standard developed through cooperation with the digital camera and printer industries, allowing photographs to be output directly to a printer without first transferring them to a computer.
- **HDMI:** **H**igh-**D**efinition **M**ultimedia **I**nterface is a standard for multimedia interfaces used in consumer electronics and AV devices capable of transmitting audiovisual data and control signals to HDMI-compliant devices via a single cable connection.

Conformity Marking

The standards with which the camera complies can be viewed using the **Conformity marking** option in the setup menu (□ 273).

FreeType License (FreeType2)

Portions of this software are copyright © 2012 The FreeType Project (<http://www.freetype.org>). All rights reserved.

MIT License (HarfBuzz)

Portions of this software are copyright © 2017 The HarfBuzz Project (<http://www.freedesktop.org/wiki/Software/HarfBuzz>). All rights reserved.

Trademark Information

IOS is a trademark or registered trademark of Cisco Systems, Inc., in the United States and/or other countries and is used under license. Windows is either a registered trademark or a trademark of Microsoft Corporation in the United States and/or other countries. Mac, macOS, OS X, Apple®, App Store®, the Apple logos, iPhone®, iPad®, and iPod touch® are trademarks of Apple Inc. registered in the U.S. and/or other countries. Android, Google Play and the Google Play logo are trademarks of Google LLC. The Android robot is reproduced or modified from work created and shared by Google and used according to terms described in the Creative Commons 3.0 Attribution License. PictBridge logo is a trademark. The SD, SDHC, and SDXC logos are trademarks of the SD-3C, LLC. HDMI, the HDMI logo and High-Definition Multimedia Interface are trademarks or registered trademarks of HDMI Licensing LLC.

HDMI

Wi-Fi and the Wi-Fi logo are trademarks or registered trademarks of the Wi-Fi Alliance.

The Bluetooth® word mark and logos are registered trademarks owned by Bluetooth SIG, Inc. and any use of such marks by Nikon Corporation is under license.

All other trade names mentioned in this manual or the other documentation provided with your Nikon product are trademarks or registered trademarks of their respective holders.

Use of the Made for Apple badge means that an accessory has been designed to connect specifically to the Apple products identified in the badge, and has been certified by the developer to meet Apple performance standards. Apple is not responsible for the operation of this device or its compliance with safety and regulatory standards. Please note that the use of this accessory with an Apple product may affect wireless performance.

Certificates

• México

IFETEL: RCPMULB16-0363

LBEE5UW1FS

Módulo WLAN instalado adentro de esta computadora
La operación de este equipo está sujeta a las siguientes
dos condiciones:

- (1) es posible que este equipo o dispositivo no cause interferencia perjudicial y
- (2) este equipo o dispositivo debe aceptar cualquier interferencia, incluyendo la que pueda causar su operación no deseada.

• Paraguay

Número del Registro: 2016-01-I-0000022

Este producto contiene un transmisor
aprobado por la CONATEL.

• Maroc/

المغرب

AGREE PAR L'ANRT MAROC

Numéro d'agrément : MR 13153 ANRT 2017

Date d'agrément : 24/01/2017

• Indonesia

49678/SDPPI/2017

4588

49647/SDPPI/2017

4593

الأردن •

TRC/SS/2017/59

عمان •

OMAN-TRA

R/3918/17

D090024

الإمارات العربية المتحدة •

TRA

REGISTERED No:

ER45171/16

DEALER No:

DA39487/15

AF-S DX NIKKOR 18–140mm f/3.5–5.6G ED VR Lenses

Read this section if you purchased the camera with the AF-S DX NIKKOR 18–140mm f/3.5–5.6G ED VR lens kit available in some countries or regions. The parts of the lens are listed below.

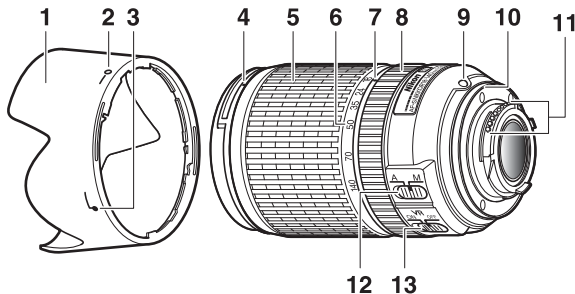

1 Lens hood *334	8 Focus ring 115
2 Lens hood lock mark334	9 Lens mounting mark..... 24
3 Lens hood alignment mark334	10 Rubber lens-mount gasket
4 Lens hood mounting mark.....334	11 CPU contacts.....280
5 Zoom ring51	12 A-M mode switch.....330
6 Focal length scale	13 Vibration reduction ON/OFF switch332
7 Focal length mark	

* Optional.

■ Focus

Focus mode is determined by the camera focus mode and the position of the lens A-M mode switch. See the camera manual for information on camera focus mode selection.

Camera focus mode	Lens focus mode	
	A	M
AF	Autofocus with manual override *	Manual focus with electronic rangefinder
MF	—	

* Manual override available only when single-servo AF (AF-S) is selected with the camera.

Autofocus

- 1 **Set the camera to AF (autofocus).**
- 2 **Slide the lens A-M mode switch to A.**
- 3 **Focus.**

Press the shutter-release button halfway to focus. In single-servo AF (**AF-S**), focus can be adjusted by keeping the shutter-release button pressed halfway after the autofocus operation is complete and manually rotating the focus ring. Do not rotate the focus ring until the autofocus operation is complete. To refocus using autofocus, press the shutter-release button halfway or press the **AF-ON** button.

Manual Focus

- 1 **Slide the lens A-M mode switch to M.**
- 2 **Focus.**
Focus manually using the lens focus ring.

■ Zoom and Depth of Field

Before focusing, rotate the zoom ring to adjust the focal length and frame the photograph. If the camera offers depth-of-field preview (stop down), depth of field can be previewed in the viewfinder.

Note: Focal length decreases as the focus distance shortens.

■ ■ Aperture

Aperture is adjusted using camera controls.

Zoom and Maximum Aperture

Changes to zoom can alter the maximum aperture by up to $1\frac{1}{3}$ EV. The camera however automatically takes this into account when setting exposure, and no modifications to camera settings are required following adjustments to zoom.

■ ■ Using the Built-in Flash

When using the built-in flash, be sure the subject is at a range of at least 0.6 m (2 ft) and remove lens hoods to prevent vignetting (shadows created where the end of the lens obscures the built-in flash).

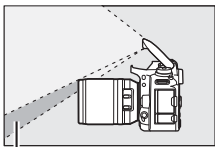

Shadow



Vignetting

When the lens is mounted on the following cameras, the built-in flash may be unable to light the entire subject at ranges less than those given below:

Camera	Zoom position	Minimum distance without vignetting
D7500/D7200/D7100/D7000/ D300 series/D200/D100	18 mm	1.0 m/3 ft 4 in.
	24–140 mm	No vignetting
D90/D80/D50	18 mm	2.5 m/8 ft 3 in.
	24 mm	1.0 m/3 ft 4 in.
	35–140 mm	No vignetting
D5600/D5500/D5300/D5200/ D5100/D5000/D3400/D3300/ D3200/D3100/D3000/D70 series/ D60/D40 series	24 mm	1.0 m/3 ft 4 in.
	35–140 mm	No vignetting

■ **Vibration Reduction (VR)**

Vibration reduction (VR) reduces blur caused by camera shake, allowing shutter speeds up to 4 stops slower than would otherwise be the case (measured at 140 mm with a D300s camera according to Camera and Imaging Products Association [CIPA] standards; effects vary with the photographer and shooting conditions). This increases the range of shutter speeds available and permits hand-held, tripod-free photography in a wide range of situations.

Using the Vibration Reduction ON/OFF Switch

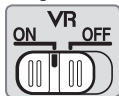

- **Select ON to enable vibration reduction.** Vibration reduction is activated when the shutter-release button is pressed halfway, reducing the effects of camera shake for improved framing and focus.
- **Select OFF to turn vibration reduction off.**

✔ Using Vibration Reduction: Notes

- When using vibration reduction, press the shutter-release button halfway and wait for the image in the viewfinder to stabilize before pressing the shutter-release button the rest of the way down.
- When vibration reduction is active, the image in the viewfinder may jiggle after the shutter is released. This does not indicate a malfunction.
- When the camera is panned, vibration reduction applies only to motion that is not part of the pan (if the camera is panned horizontally, for example, vibration reduction will be applied only to vertical shake), making it much easier to pan the camera smoothly in a wide arc.
- Do not turn the camera off or remove the lens while vibration reduction is in effect. If power to the lens is cut while vibration reduction is on, the lens may rattle when shaken. This is not a malfunction, and can be corrected by reattaching the lens and turning the camera on.
- If the camera is equipped with a built-in flash, vibration reduction will be disabled while the flash charges.
- Select **OFF** when the camera is mounted on a tripod unless the tripod head is unsecured or the camera is mounted on a monopod, in which case **ON** is recommended.

■ The Lens Hood

The lens hood protects the lens and blocks stray light that would otherwise cause flare or ghosting.

Attaching the Hood

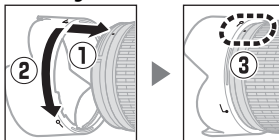

Align the lens hood mounting mark (●) with the lens hood alignment mark (☐) and then rotate the hood (②) until the ● mark is aligned with the lens hood lock mark (—○).

When attaching or removing the hood, hold it near the ☐ symbol on its base and avoid gripping it too tightly. Vignetting may occur if the hood is not correctly attached.

The hood can be reversed and mounted on the lens when not in use.

■ Supplied Accessories

- LC-67 67 mm snap-on Front Lens Cap
- Rear Lens Cap

■ Compatible Accessories

- 67 mm screw-on filters
- HB-32 Bayonet Hood
- CL-1018 Flexible Lens Pouch

■ Specifications

Type	Type G AF-S DX lens with built-in CPU and F mount
Focal length	18–140 mm
Maximum aperture	f/3.5–5.6
Lens construction	17 elements in 12 groups (including 1 ED lens element, 1 aspherical lens element)
Angle of view	76° – 11° 30′
Focal length scale	Graduated in millimeters (18, 24, 35, 50, 70, 140)
Distance information	Output to camera
Zoom	Manual zoom using independent zoom ring
Focusing	Nikon Internal Focusing (IF) System with autofocus controlled by Silent Wave Motor and separate focus ring for manual focus
Vibration reduction	Lens shift using voice coil motors (VCMs)
Minimum focus distance	0.45 m (1.48 ft) from focal plane at all zoom positions
Diaphragm blades	7 (rounded diaphragm opening)
Diaphragm	Fully automatic
Aperture range	<ul style="list-style-type: none">• 18 mm focal length: f/3.5–22• 140 mm focal length: f/5.6–38 The minimum aperture displayed may vary depending on the size of the exposure increment selected with the camera.
Metering	Full aperture
Filter-attachment size	67 mm (P = 0.75 mm)
Dimensions	Approx. 78 mm maximum diameter × 97 mm (distance from camera lens mount flange)
Weight	Approx. 490 g (17.3 oz)

Nikon reserves the right to change the appearance and specifications of the hardware and software described in this manual at any time and without prior notice. Nikon will not be held liable for damages that may result from any mistakes that this manual may contain.

AF-S DX NIKKOR 18–200mm f/3.5–5.6G ED VR II Lenses

Read this section if you purchased the camera with the AF-S DX NIKKOR 18–200mm f/3.5–5.6G ED VR II lens kit available in some countries or regions. The parts of the lens are listed below.

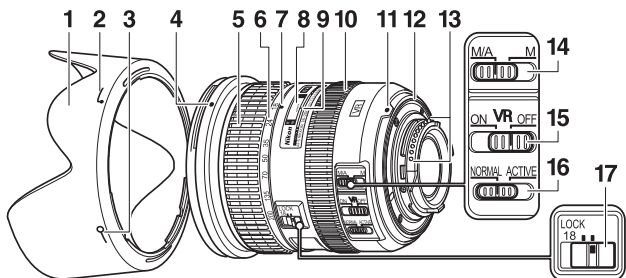

1 Lens hood342	10 Focus ring 115
2 Lens hood attachment index...342	11 Mounting index..... 24
3 Lens hood lock mark342	12 Lens mount rubber gasket
4 Lens hood mounting index342	13 CPU contacts280
5 Zoom ring 51	14 Focus mode switch.....337
6 Focal length scale	15 Vibration reduction ON/OFF switch340
7 Focal length index	16 Vibration reduction mode switch340
8 Distance scale	17 Zoom lock switch
9 Distance index line	

■ ■ Focus

Focus mode is determined by the camera focus mode and the position of the lens focus mode switch. See the camera manual for information on camera focus mode selection.

Camera focus mode	Lens focus mode	
	M/A	M
AF	Autofocus with manual override	Manual focus with electronic rangefinder
MF	Manual focus with electronic rangefinder	

M/A (Autofocus with Manual Override)

1 Slide the lens focus-mode switch to M/A.

2 Focus.

If desired, autofocus can be over-ridden by rotating the lens focus ring while the shutter-release button is pressed halfway (or, if the camera is equipped with an **AF-ON** button, while the **AF-ON** button is pressed). To re-focus using autofocus, press the shutter-release button halfway or press the **AF-ON** button again.

Getting Good Results with Autofocus

Refer to “A Note on Wide- and Super Wide-Angle Lenses” (📖 345).

■ ■ *Zoom and Depth of Field*

Before focusing, rotate the zoom ring to adjust the focal length and frame the photograph. If the camera offers depth-of-field preview (stop down), depth of field can be previewed in the viewfinder.

Note: The lens uses Nikon's Internal Focusing (IF) system. Unlike other lenses, focal length decreases as the focus distance shortens. Note that the focus distance indicator is intended only as a guide and may not accurately show the distance to the subject and may, due to depth of field or other factors, not show ∞ when the camera is focused on a distant object.

To lock the zoom ring, rotate it to the 18 mm position and slide the zoom lock switch to **LOCK**. This prevents the lens extending under its own weight while the camera is being carried from place to place.

■ ■ *Aperture*

Aperture is adjusted using camera controls.

Zoom and Maximum Aperture

Changes to zoom can alter the maximum aperture by up to 1⅓ EV. The camera however automatically takes this into account when setting exposure, and no modifications to camera settings are required following adjustments to zoom.

■ ■ Using the Built-in Flash

When using the built-in flash, be sure the subject is at a range of at least 0.6 m (2 ft) and remove lens hoods to prevent vignetting (shadows created where the end of the lens obscures the built-in flash).

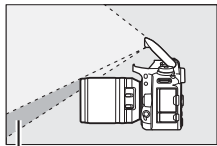

Shadow



Vignetting

When the lens is mounted on the following cameras, the built-in flash may be unable to light the entire subject at ranges less than those given below:

Camera	Zoom position	Minimum distance without vignetting
D7500/D7200/D7100/D7000/ D300 series/D200/D100	18 mm	1.0 m/3 ft 4 in.
	24–200 mm	No vignetting
D90/D80	24 mm	1.0 m/3 ft 4 in.
	35 mm	1.0 m/3 ft 4 in.
	50–200 mm	No vignetting
D5600/D5500/D5300/D5200/ D5100/D5000/D3400/D3300/ D3200/D3100/D3000/D70 series/ D60/D50/D40 series	24 mm	1.0 m/3 ft 4 in.
	35–200 mm	No vignetting

■ ■ *Vibration Reduction (VR)*

Using the Vibration Reduction ON/OFF Switch

- Select **ON** to enable vibration reduction. Vibration reduction is activated when the shutter-release button is pressed halfway, reducing the effects of camera shake for improved framing and focus.
- Select **OFF** to turn vibration reduction off.

Using the Vibration Reduction Mode Switch

- Select **NORMAL** for enhanced vibration reduction when photographing stationary subjects.
- Select **ACTIVE** to reduce the effects of vibration when shooting from a moving vehicle, and in other situations with active camera motion.

✔ Using Vibration Reduction: Notes

- When using vibration reduction, press the shutter-release button halfway and wait for the image in the viewfinder to stabilize before pressing the shutter-release button the rest of the way down.
- When vibration reduction is active, the image in the viewfinder may jiggle after the shutter is released. This does not indicate a malfunction.
- Slide the vibration reduction mode switch to **NORMAL** for panning shots. When the camera is panned, vibration reduction applies only to motion that is not part of a pan (if the camera is panned horizontally, for example, vibration reduction will be applied only to vertical shake), making it much easier to pan the camera smoothly in a wide arc.
- Do not turn the camera off or remove the lens while vibration reduction is in effect. If power to the lens is cut while vibration reduction is on, the lens may rattle when shaken. This is not a malfunction, and can be corrected by reattaching the lens and turning the camera on.
- If the camera is equipped with a built-in flash, vibration reduction will be disabled while the flash charges.
- In the case of cameras equipped with an **AF-ON** button, vibration reduction will not be performed when the **AF-ON** button is pressed.
- Select **OFF** when the camera is mounted on a tripod unless the tripod head is unsecured or the camera is mounted on a monopod, in which case **ON** is recommended.

■ The Lens Hood

The lens hood protects the lens and blocks stray light that would otherwise cause flare or ghosting.

Attaching the Hood

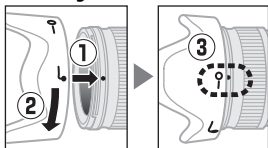

Align the lens hood mounting mark (●) with the lens hood alignment mark (└) and then rotate the hood (②) until the ● mark is aligned with the lens hood lock mark (—○).

When attaching or removing the hood, hold it near the └ symbol on its base and avoid gripping it too tightly. Vignetting may occur if the hood is not correctly attached.

The hood can be reversed and mounted on the lens when not in use.

■ Supplied Accessories

- LC-72 72 mm snap-on Front Lens Cap
- Rear Lens Cap
- HB-35 Bayonet Hood
- CL-1018 Flexible Lens Pouch

■ Compatible Accessories

72 mm screw-on filters

■ Specifications

Type	Type G AF-S DX Zoom-NIKKOR lens with built-in CPU and F mount, designed for use with Nikon DX-format digital SLR cameras
Focal length	18–200 mm
Maximum aperture	f/3.5–5.6
Lens construction	16 elements in 12 groups (including 2 ED lens elements and 3 aspherical lens elements)
Angle of view	76°–8°
Focal length scale	Graduated in millimeters (18, 24, 35, 50, 70, 135, 200)
Distance information	Output to camera
Zoom	Manual zoom using independent zoom ring
Focusing	Nikon Internal Focusing (IF) System with autofocus controlled by Silent Wave Motor and separate focus ring for manual focus
Vibration reduction	Lens shift using voice coil motors (VCMs)
Focus distance indicator	0.5 m to infinity (∞)
Minimum focus distance	0.5 m (1.6 ft.) from focal plane at all zoom positions
Diaphragm blades	7 (rounded diaphragm opening)
Diaphragm	Fully automatic
Aperture range	<ul style="list-style-type: none">• 18 mm focal length: f/3.5–22• 200 mm focal length: f/5.6–36
Metering	Full aperture
Filter-attachment size	72 mm (P = 0.75 mm)
Dimensions	Approx. 77 mm maximum diameter × 96.5 mm (distance from camera lens mount flange)
Weight	Approx. 565 g (19.9 oz)

Nikon reserves the right to change the appearance and specifications of the hardware and software described in this manual at any time and without prior notice. Nikon will not be held liable for damages that may result from any mistakes that this manual may contain.

✔ Lens Care

- Keep the CPU contacts clean.
- Should the rubber lens-mount gasket be damaged, cease use immediately and take the lens to a Nikon-authorized service center for repair.
- Use a blower to remove dust and lint from the lens surfaces. To remove smudges and fingerprints, apply a small amount of ethanol or lens cleaner to a soft, clean cotton cloth or lens-cleaning tissue and clean from the center outwards using a circular motion, taking care not to leave smears or touch the glass with your fingers.
- Never use organic solvents such as paint thinner or benzene to clean the lens.
- The lens hood or Neutral Color (NC) filters can be used to protect the front lens element.
- Attach the front and rear caps before placing the lens in its case.
- When a lens hood is attached, do not pick up or hold the lens or camera using only the hood.
- If the lens will not be used for an extended period, store it in a cool, dry location to prevent mold and rust. Do not store in direct sunlight or with naphtha or camphor moth balls.
- Keep the lens dry. Rusting of the internal mechanism can cause irreparable damage.
- Leaving the lens in extremely hot locations could damage or warp parts made from reinforced plastic.

🔍 A Note on Wide- and Super Wide-Angle Lenses

Autofocus may not provide the desired results in situations like those shown below.

1 Objects in the background occupy more of the focus point than the main subject:

If the focus point contains both foreground and background objects, the camera may focus on the background and the subject may be out of focus, particularly with wide- and super wide-angle lenses.

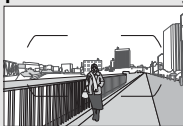

Example: *A far-off portrait subject at some distance from the background*

2 The subject contains many fine details.

The camera may have difficulty focusing on subjects that contain many fine details.

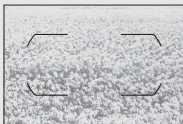

Example: *A field of flowers*

In these cases, use manual focus, or use focus lock to focus on another subject at the same distance and then recompose the photograph. For more information, see “Getting Good Results with Autofocus” (📖 114).

Approved Memory Cards

The camera supports SD, SDHC, and SDXC memory cards, including SDHC and SDXC cards compliant with UHS-I. Cards rated UHS Speed Class 3 or better are recommended for movie recording; using slower cards may result in recording being interrupted. When choosing cards for use in card readers, be sure they are compatible with the device. Contact the manufacturer for information on features, operation, and limitations on use.



Memory Card Capacity

The following table shows the approximate number of pictures that can be stored on a 16 GB SanDisk Extreme Pro 95 MB/s UHS-I SDHC card at different image quality (📖 97), image size (📖 99), and image area settings (as of June 2017; 📖 93).

■ DX (24×16) Image Area

Image quality	Image size	File size ¹	No. of images ¹	Buffer capacity ²
NEF (RAW), Lossless compressed, 12-bit	—	20.5 MB	436	74
NEF (RAW), Lossless compressed, 14-bit	—	25.5 MB	339	50
NEF (RAW), Compressed, 12-bit	—	17.5 MB	587	100
NEF (RAW), Compressed, 14-bit	—	21.5 MB	492	73
JPEG fine ³	Large	10.4 MB	1000	100
	Medium	6.3 MB	1700	100
	Small	3.4 MB	3300	100
JPEG normal ³	Large	5.3 MB	2000	100
	Medium	3.3 MB	3300	100
	Small	1.8 MB	6300	100
JPEG basic ³	Large	2.8 MB	4000	100
	Medium	1.8 MB	6300	100
	Small	1.0 MB	11,300	100

■ 1.3× (18×12) Image Area

Image quality	Image size	File size ¹	No. of images ¹	Buffer capacity ²
NEF (RAW), Lossless compressed, 12-bit	—	13.1 MB	713	100
NEF (RAW), Lossless compressed, 14-bit	—	15.6 MB	559	100
NEF (RAW), Compressed, 12-bit	—	11.0 MB	949	100
NEF (RAW), Compressed, 14-bit	—	13.4 MB	803	100
JPEG fine ³	Large	6.6 MB	1700	100
	Medium	4.2 MB	2700	100
	Small	2.4 MB	4600	100
JPEG normal ³	Large	3.4 MB	3300	100
	Medium	2.2 MB	5100	100
	Small	1.3 MB	8600	100
JPEG basic ³	Large	1.8 MB	6200	100
	Medium	1.2 MB	9500	100
	Small	0.8 MB	14,700	100

1 All figures are approximate. File size varies with scene recorded.

2 Maximum number of exposures that can be stored in memory buffer at ISO 100. Drops at image qualities marked with a star ("★") or when auto distortion control is on.

3 Figures assume size-priority JPEG compression. Selecting an image-quality option marked with a star ("★"; optimal compression) increases the file size of JPEG images; number of images and buffer capacity drop accordingly.

📷 d2—Max. Continuous Release (📖 263)

The maximum number of photographs that can be taken in a single burst can be set to any amount between 1 and 100.

Battery Life

The movie footage or number of shots that can be recorded with fully-charged batteries varies with the condition of the battery, temperature, interval between shots, and the length of time menus are displayed. Sample figures for EN-EL15a (1900 mAh) batteries are given below¹.

- **Photographs, single-frame release mode (CIPA standard²):**

Approximately 950 shots

- **Photographs, continuous release mode (Nikon standard³):**

Approximately 3880 shots

- **Movies⁴:** Approximately 80 minutes of HD footage

- 1 EN-EL15b or EN-EL15 batteries can also be used in place of the EN-EL15a, but note that fewer pictures may sometimes be taken on a single charge with an EN-EL15 than with an EN-EL15b/EN-EL15a.
- 2 Measured at 23 °C/73.4 °F (±2 °C/3.6 °F) with an AF-S DX NIKKOR 18–140mm f/3.5–5.6G ED VR lens under the following test conditions: lens cycled from infinity to minimum range and one photograph taken at default settings once every 30 s; flash fired once every other shot. Live view not used.
- 3 Measured at 23 °C/73.4 °F (±2 °C/3.6 °F) with an AF-S DX NIKKOR 18–140mm f/3.5–5.6G ED VR lens under the following test conditions: image quality set to JPEG normal, image size set to **L** (large), shutter speed $\frac{1}{250}$ s, shutter-release button pressed halfway for three seconds and focus cycled from infinity to minimum range three times; six shots are then taken in succession and monitor turned on for five seconds and then turned off; cycle repeated once standby timer expires.
- 4 Measured at 23 °C/73.4 °F (±2 °C/3.6 °F) with the camera at default settings and an AF-S DX NIKKOR 18–140mm f/3.5–5.6G ED VR lens under conditions specified by the Camera and Imaging Products Association (CIPA). Individual movies are composed of one or more files, each up to 4 GB in size, and can total up to 29 minutes 59 seconds in length; recording may end before these limits are reached if the camera temperature rises.

The following can reduce battery life:



























- Using the monitor
- Keeping the shutter-release button pressed halfway
- Repeated autofocus operations
- Taking NEF (RAW) photographs
- Slow shutter speeds
- Using camera Wi-Fi (wireless LAN) and Bluetooth features
- Using the camera with optional accessories connected
- Using VR (vibration reduction) mode with VR lenses
- Repeatedly zooming in and out with an AF-P lens.





















To ensure that you get the most from Nikon EN-EL15a rechargeable Li-ion batteries:

- Keep the battery contacts clean. Soiled contacts can reduce battery performance.
- Use batteries immediately after charging. Batteries will lose their charge if left unused.

Index

Symbols

 (Auto mode).....	48
 (Auto (flash off) mode).....	48
SCENE (Scene mode).....	61
EFFECTS (Special effects).....	64
 (Portrait).....	62
 (Landscape).....	62
 (Child).....	62
 (Sports).....	62
 (Close up).....	62
 (Night portrait).....	62
 (Night landscape).....	62
 (Party/indoor).....	62
 (Beach/snow).....	62
 (Sunset).....	63
 (Dusk/dawn).....	63
 (Pet portrait).....	63
 (Candlelight).....	63
 (Blossom).....	63
 (Autumn colors).....	63
 (Food).....	63
 (Night vision).....	64
VI (Super Vivid).....	64
POP (Pop).....	64
 (Photo Illustration).....	64, 66
 (Toy Camera Effect).....	64, 67
 (Miniature effect).....	65, 68
 (Selective color).....	65, 70
 (Silhouette).....	65
 (High key).....	65
 (Low key).....	65
P (Programmed auto).....	73
S (Shutter-priority auto).....	74
A (Aperture-priority auto).....	75
M (Manual).....	76
U1/U2	83
S (Single frame).....	86

CL (Continuous low speed).....	86
CH (Continuous high speed).....	86
Q (Quiet shutter-release).....	86
QC (Quiet continuous shutter-release).....	86
 (Self-timer).....	86, 89
MUP (Mirror up).....	86, 91
 (Face-priority AF).....	106
 (Wide-area AF).....	106
 (Normal-area AF).....	106
 (Subject-tracking AF).....	107
 (Matrix).....	123
 (Center-weighted).....	123
 (Spot).....	123
 (Highlight-weighted).....	123
AUTO (Auto flash).....	160
 (Red-eye reduction).....	160, 162
SLOW (Slow sync).....	160, 162
REAR (Rear-curtain sync).....	162
 (Exposure compensation).....	127
 (Flash compensation).....	167
 (Flexible program).....	73
 (Live view) button.....	49, 179
 button.....	183, 205, 230
 (Info) button.....	56, 187, 201
 button.....	42, 266
 switch.....	5
PRE (Preset manual).....	131, 139
BKT (Bracketing).....	209
 (Focus indicator).....	52, 111, 116
 (Memory buffer).....	87
 (Flash-ready indicator).....	55

Numerics

1.3x.....	190
1.3x (18x12).....	93
3D-tracking.....	104, 105, 109

A

AC adapter.....	287
Accessories.....	287
Active D-Lighting 153, 183, 219, 254, 258	
ADL bracketing.....	209, 219
AE & flash bracketing.....	209, 210
AE bracketing.....	209, 210
AE lock.....	125
AE-L/AF-L button.....	112, 125
AF.....	100–114
AF activation.....	261
AF area brackets.....	9, 11, 232
AF fine-tune.....	269
AF-A.....	100
AF-area mode.....	103
AF-assist.....	261
AF-C.....	100, 260
AF-F.....	101
AF-mode button.....	101, 108
AF-P.....	279
AF-S.....	100, 101, 260, 279
After delete.....	251
Airplane mode.....	272
A-M mode switch.....	329
Angle of view.....	284
Aperture.....	75–76
Aperture-priority auto.....	75
Aspect ratio.....	190
Assign remote (WR) Fn button....	272
Attaching the lens.....	24
Auto (Set Picture Control).....	148
Auto (White balance).....	130, 132
Auto bracketing set.....	209, 256
Auto distortion control.....	255
Auto flash.....	160
Auto image rotation.....	251
Auto info display.....	269
Auto ISO sensitivity control. 120, 257	
Auto  ISO sensitivity control.....	266

Auto-area AF.....	104, 109
Autoexposure lock.....	125
Autofocus.....	100–114
Autofocus mode.....	100
Auto-servo AF.....	100

B

Backlight.....	5
Battery.....	19, 21, 46, 273, 325
Battery info.....	273
Battery life.....	349
Beep options.....	271
BKT button.....	158, 266
Bluetooth.....	xxii, 273
Body cap.....	3, 287
Bracketing.....	209, 256
Built-in flash.....	55, 159
Bulb.....	79, 80

C

Camera Control Pro 2.....	287
Capture NX-D.....	iv
Center-weighted.....	123, 262
Charging the battery.....	19
Choose color temp. (White balance). 131, 137	
Choose image area 93, 190, 252, 257	
Choose start/end point.....	196
CL mode shooting speed.....	263
Clean image sensor.....	289
Clock.....	268
Clock battery.....	204
Cloudy (White balance).....	131
Color outline.....	276
Color sketch.....	276
Color space.....	254
Color temperature.....	131, 133, 137
Command dial.....	266
Compatible lenses.....	279
Conformity marking.....	273, 326
Connect to smart device.....	272

Connector for external microphone .	2
Continuous high speed	86
Continuous low speed	86
Continuous release mode	86
Continuous-servo AF	100
Control panel	8
Copyright	238, 271
CPU contacts	280
CPU lens.....	25, 279
Crop.....	190
Custom control assignment	266, 267
Custom Settings	260

D

Date and time	268
Date format	268
Daylight saving time	268
DCF	326
Default settings.....	206, 274
Delayed remote (Remote control mode (ML-L3))	175
Delete	60, 247
Delete all images	248
Delete current image.....	60, 247
Delete selected images.....	248
Diopter adjustment control .	11, 287, 301
Direct sunlight (White balance) ..	131
Distortion control.....	275
D-Lighting.....	275
DX (24×16).....	93
DX format.....	190
Dynamic-area AF	103, 109

E

Edit movie	196, 230, 277
Electronic front-curtain shutter ..	264
Electronic rangefinder.....	116
Electronic VR	184, 259
EV steps for exposure cntrl	262

Exif.....	326
Exposure	123–129
Exposure bracketing.....	209, 210, 256
Exposure compensation	127, 262, 265
Exposure delay mode.....	264
Exposure indicator	77, 267
Exposure lock	125
Exposure meters	54
Exposure preview	78
External GPS device options.....	223
External microphone.....	184
Eye sensor.....	13
Eye-Fi upload.....	273

F

Face-priority AF	106
File naming	252, 257
File number sequence	264
Filter effects	152, 276
Fine-tune optimal exposure	262
Fine-tuning white balance	134
Firmware version	274
Fisheye.....	276
Flash.....	55, 159, 160, 167, 169
Flash (White balance).....	131
Flash bracketing.....	209, 210, 256
Flash compensation.....	167
Flash control	252
Flash mode.....	160, 162
Flash range.....	166
Flash ready indicator	55, 170, 271
Flash shutter speed.....	163, 265
Flash sync speed	265, 317
Flash warning.....	271
Flat (Set Picture Control)	148
Flexible program.....	73
Flick.....	14, 271
Flicker reduction	255, 259
Fluorescent (White balance).....	130
Fn1 button.....	266, 267

Fn2 button	266, 267
f-number	72, 281
Focal length	283
Focal length scale	329, 336
Focal plane mark.....	116
Focus indicator	52, 111, 116
Focus lock	111
Focus mode.....	100
Focus point.....	51, 52, 103, 107, 116, 261
Focus tracking	102, 260
Focusing screen.....	316
Focus-mode selector	100
Format memory card.....	268
Frame rate.....	188
Frame size/frame rate.....	188, 257
Framing guides.....	56, 187
Frequency response.....	183, 259
Front-curtain sync.....	162
Full-frame playback.....	225
Full-frame playback flicks.....	271
Full-time servo AF	101
FV lock.....	169

G

GPS	223, 238
Group-area AF	104

H

H.264.....	321
HDMI.....	192, 271, 326
HDMI connector	2
Headphone volume	184
Headphones.....	184
Help.....	42
Hi.....	119
Hide image	250
High definition	326
High Dynamic Range (HDR)	155, 256
High ISO NR.....	255, 259
Highlight display	184
Highlights	233

Highlight-weighted metering.....	123
Histogram.....	234, 235

I

Image area	93, 95, 99, 183, 252, 257
Image comment.....	270
Image Dust Off ref photo.....	270
Image overlay	276
Image quality	97, 253
Image review.....	227, 250
Image size.....	99, 253
Incandescent (White balance)	130
Index marking.....	189, 195
Info display auto off.....	13, 269
In-focus indicator.....	52, 111, 116
Information.....	201, 231
Information display.....	201, 269
Interval timer shooting.....	256
ISO display.....	264
ISO sensitivity.....	118, 120, 253, 257, 264
ISO sensitivity settings.....	120, 253, 257
ISO sensitivity step value	261
i-TTL	165

J

JPEG	97
JPEG basic.....	97
JPEG fine	97
JPEG normal.....	97

L

L (large)	99, 192
Landscape (Set Picture Control)..	148
Language.....	268, 323
LCD illumination	5, 264
LED lamp.....	271
Lens.....	24, 25, 279, 329
Lens focus ring.....	115, 329, 336
Lens mount.....	3, 24, 116
Lens mounting mark	24

Lens vibration reduction switch 332, 340
LINK mode 271
Live view 49, 179–193
Live view selector 49, 179
Lo 119
Location data 223, 238
Lock mirror up for cleaning 292
Long exposure NR 255

M

M (medium) 99, 192
Manage Picture Control 254, 258
Manual 76, 115
Manual focus 115
Manual focus ring in AF mode 261
Matrix metering 123, 262
Max. continuous release 263
Maximum aperture 166, 281
Maximum sensitivity 121, 257
Memory buffer 87
Memory card 21, 47, 346, 347
Memory card capacity 347
Menu Guide iii
Metering 123
Microphone 183, 184, 259
Microphone sensitivity 183, 259
Miniature effect 65, 68, 277
Minimum aperture 25, 72
Minimum shutter speed 121
Mired 136
Mirror 91, 175, 292
Mirror up 86, 91
Mode dial 6
Mode dial lock release 6
Monitor 12, 14, 59, 225
Monitor brightness 184, 269
Monitor color balance 269
Monitor off delay 263
Monitor pre-flash 165, 170
Monochrome 148, 276

Mounting mark 24, 329, 336
Movie file type 257
Movie live view 179
Movie quality 188, 257
Movie shooting menu 257
Movie-record button 181, 266
Movies 179
Multiple exposure 256
Multi-selector power aperture 184
MY MENU 278

N

NEF (RAW) 97
NEF (RAW) processing 275
NEF (RAW) recording 253
Neutral (Set Picture Control) 148
Non-CPU lens 285
Normal-area AF 106
Number of focus points 260
Number of shots 349

O

OK button 42, 266
Optical VR 265
Overview data 239

P

Painting 277
Perspective control 276
Photo illustration 64, 276
Photo information 231
Photo shooting menu 252
PictBridge 326
Picture Controls 148, 150
Picture size 284
Playback 59, 225
Playback display options 231, 250
Playback folder 250
Playback information 231
Playback menu 250
Playback zoom 240

Pop	64
Portrait (Set Picture Control).....	148
Power aperture	184
Power connector.....	287
Predictive focus tracking.....	102
Preset manual (White balance)..	131, 139
Press the shutter-release button all the way down.....	53
Press the shutter-release button halfway.....	52
Programmed auto	73
Protecting photographs.....	242

Q

Quick retouch.....	275
Quick-response remote (Remote control mode (ML-L3)).....	175
Quiet continuous shutter-release.	86
Quiet shutter-release.....	86

R

Rating	243, 251
Rear-curtain sync.....	162
RECENT SETTINGS	278
Rechargeable Li-ion battery.....	19
Red-eye correction	275
Red-eye reduction	160, 162
Release button to use dial	267
Release mode	86
Release mode dial.....	86
Release mode dial lock release	86
Remote control.....	175, 287
Remote control mode (ML-L3) ...	175, 256
Remote cord	79, 287
Remote mirror-up (Remote control mode (ML-L3)).....	175
Remote on duration (ML-L3).....	263
Removing the lens from the camera	25

Reset.....	206, 274
Reset all settings	274
Reset custom settings.....	260
Reset movie shooting menu	257
Reset photo shooting menu.....	252
Reset user settings	85
Resize	275
Restoring default settings ...	206, 274
Retouch menu	230, 275
Reverse indicators	267
RGB	234
Rotate tall	251

S

S (small).....	99, 192
Save selected frame.....	196, 200
Save user settings.....	83
Save/load settings	274
Scene mode	61
SD memory card	47, 347
Select date.....	249, 250
Select to send to smart device....	246, 251
Select to send to smart device/ deselect	245
Selective color.....	65, 70, 277
Self-timer	86, 89, 263
Send to smart device (auto).....	273
Sensitivity	118, 120, 253, 257
Set clock from satellite.....	223
Set Picture Control	148, 254, 258
Setup menu	268
Shade (White balance).....	131
Shooting data	236
Shutter speed.....	74, 76
Shutter-priority auto	74
Shutter-release button .	53, 111, 125, 262, 267
Shutter-release button AE-L	262
Side-by-side comparison	277
Single frame.....	86

Single-point AF	103, 109
Single-servo AF	100, 101
Size	99, 192
Slide show	251
Slot empty release lock	273
Slow sync.....	160, 162
Slow-motion playback	194
Smart device	224, 251, 272
Speaker	5
Special effects.....	64
Spot	123
Spot white balance.....	143
Standard (Set Picture Control).....	148
Standard i-TTL fill-flash for digital SLR	165
Standby timer.....	54, 223, 263
Storage folder.....	252
Store points by orientation	261
Straighten	275
Subject-tracking AF	107
Super vivid	64

T

Text entry	270
Thumbnail.....	225
Tilting monitor	12
Time	79, 81, 268
Time zone.....	268
Time zone and date.....	268
Time-lapse movie.....	259
Timer.....	89
Toning.....	151, 152
Touch controls	14, 228, 271
Touch screen.....	14, 16, 228
Touch shutter	16
Toy camera effect.....	64
Trim	275
Trimming movies	196
Tripod	3
Two-button reset	206
Type D lens	280

Type E lens.....	280
Type G lens.....	280

U

User settings	83
UTC.....	224

V

Vibration reduction.....	184, 259, 332, 340
Viewfinder	9, 11, 287, 316
Viewfinder eyepiece	90
Viewfinder eyepiece cap.....	90
Viewfinder focus	11, 287
Viewfinder grid display.....	264
ViewNX-i.....	iv
Vignette control	255
Virtual horizon	56, 187, 269
Vivid (Set Picture Control).....	148
Volume	195

W

WB (White balance).....	130, 215, 258
WB bracketing.....	209, 215
White balance	130, 215, 254, 258
White balance bracketing....	209, 215
Wide-area AF	106
Wi-Fi.....	xxii, 273
Wind noise reduction.....	183, 259
Wireless	xxii
Wireless remote (WR) options.....	271
Wireless remote controller .	271, 272, 287

No reproduction in any form of this manual, in whole or in part (except for brief quotation in critical articles or reviews), may be made without written authorization from NIKON CORPORATION.

NIKON CORPORATION

Printed in Thailand

© 2017 Nikon Corporation



6MB38411-05