

# ***Nikon***

DIGITAL CAMERA

# **D6**

## Reference Manual

- Read this manual thoroughly before using the camera.
- To ensure proper use of the camera, be sure to read "For Your Safety" (page xli).
- After reading this manual, keep it in a readily accessible place for future reference.

**En**

# Package Contents

Be sure all items listed here were included with your camera.

- Camera



- BF-1B body cap



- BS-3 accessory shoe cover  
( 1066)



- EN-EL18c rechargeable Li-ion battery with terminal cover

- MH-26a battery charger with power cable and two contact protectors (shape of power cable depends on country or region of sale)

- HDMI/USB cable clip  
( 1068)

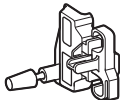

- UC-E24 USB cable

- AN-DC22 strap

- Warranty*

- User's Manual*

Memory cards are sold separately.

**D6 Model Name: N1823**

---

**✓ The Nikon Download Center**

Visit the Nikon download center to download firmware updates, ViewNX-i and other Nikon software, and manuals for Nikon products including cameras, NIKKOR lenses, and flash units.

<https://downloadcenter.nikonimglib.com/>



---



# About This Manual

## ■ Symbols

The following symbols and conventions are employed in this manual. Use them to help locate the information you need.

	This icon marks notes, information that should be read before using this product.
	This icon marks tips, additional information you may find helpful when using this product.
	This icon marks references to other sections in this manual.

## ■ Conventions

- This camera uses CFexpress (Type B) and XQD memory cards. Throughout this manual, CFexpress and XQD memory cards are generally referred to as “memory cards”. The terms “CFexpress cards” and “XQD cards” are however used where necessary to distinguish between the two types.
- Throughout this manual, battery chargers are referred to as “battery chargers” or “chargers”.
- Throughout this manual, smartphones and tablets are referred to as “smart devices”.
- Throughout this manual, the term “default settings” is used to refer to the settings in effect at shipment. The explanations in this manual assume that default settings are used.

---

**⚠ For Your Safety**

“For Your Safety” contains important safety instructions. Be sure to read them before using the camera. For more information, see “For Your Safety” (📖 xli).

---









# Table of Contents

Package Contents .....	ii
About This Manual.....	iv
Menu List.....	xxxv
For Your Safety .....	xli
Notices .....	xlix
<b>Getting to Know the Camera</b> .....	<b>1</b>
<hr/>	
Parts of the Camera .....	1
Camera Body.....	1
The Power Switch.....	8
The Top Control Panel .....	9
The Rear Control Panel.....	11
The Viewfinder .....	12
The Live View Displays (Photos/Movies).....	15
Touch Controls .....	18

<b>First Steps</b>	<b>27</b>
<hr/>	
Readying the Camera.....	27
Attaching the Strap.....	27
Charging the Battery .....	28
Inserting the Battery.....	32
Attaching a Lens.....	35
Inserting Memory Cards.....	38
Camera Setup.....	43
The Battery Level and Number of Exposures Remaining.....	47
Battery Level .....	47
Memory Card Indicators and Number of Exposures Remaining .....	48
<b>Basic Photography and Playback</b>	<b>50</b>
<hr/>	
Taking Photographs .....	50
Framing Photographs in the Viewfinder (Viewfinder Photography).....	50
Framing Photographs in the Monitor (Live View).....	55
Recording Movies.....	63
Taking Photos During Filming .....	70
Playback.....	71
Viewing Movies .....	73
Deleting Unwanted Pictures.....	76

Uploading Pictures .....	77
Uploading Pictures to Smart Devices .....	77
Uploading Pictures to a Computer or FTP Server .....	77
<b>Camera Controls</b> .....	<b>80</b>
<hr/>	
The <b>MENU</b> Button .....	80
Using the Menus.....	81
The <b>i</b> Button (the <b>i</b> Menu) .....	88
The Still Photography <b>i</b> Menu.....	90
The Movie <b>i</b> Menu .....	92
The Playback <b>i</b> Menu.....	93
The <b>info</b> Button .....	94
Viewfinder Photography .....	94
Live View Photography .....	95
The Focus-Mode Selector.....	97
The AF-Mode Button.....	98
Choosing an AF Mode .....	98
Choosing an AF-Area Mode.....	101
The AF-ON Button.....	107
The <b>MODE</b> Button.....	108
Choosing an Exposure Mode .....	108



The Release Mode Dial and  Button .....	109
Choosing a Release Mode.....	109
The  Button.....	111
Choosing a Metering Option .....	111
The BKT Button.....	113
The <b>ISO</b> (  <small>FORMAT</small> ) Button .....	114
Adjusting ISO Sensitivity .....	114
Enabling Auto ISO Sensitivity Control.....	116
The  Button.....	117
Adjusting Exposure Compensation .....	117
The <b>QUAL</b> Button .....	118
Adjusting Image Quality .....	118
Choosing an Image Size .....	120
The <b>WB</b> Button .....	121
Adjusting White Balance .....	121
The  (  <small>?</small> ) Button.....	125
Choosing a Picture Control .....	125
The  (  ) Button .....	131
Choosing a Flash Mode .....	131
Adjusting Flash Compensation .....	133
The Pv Button.....	134
The Fn1, Fn2, Fn3 (  ) , and Fn (Vertical) Buttons .....	135

---

Image Recording Options (Image Area, Quality, and Size).....	136
Adjusting Image Area Settings.....	136
Adjusting Image Quality .....	142
Choosing an Image Size.....	145
Choosing How the Camera Focuses (Focus) .....	148
Choosing a Focus Mode.....	148
Autofocus Mode .....	149
AF-Area Mode.....	153
Focus Point Selection.....	164
Custom Focus Groups .....	167
Focus Lock .....	170
Manual Focus.....	174
Exposure-Related Settings (Metering and Exposure Compensation) .....	178
Choosing How the Camera Sets Exposure.....	178
Choosing an Exposure Mode .....	182
Long Time-Exposures (Mode M Only) .....	191
Shutter Speed and Aperture Lock.....	194
Autoexposure Lock.....	196
Exposure Compensation .....	199

Choosing the Operation Performed When the Shutter Is Released (Release Mode).....	203
Choosing a Release Mode Such as Single-Frame, Continuous, or Quiet Shutter-Release.....	203
Using the Self-Timer (Ⓢ).....	209
Mirror Up Mode (Mup).....	211
Adjusting the Camera's Sensitivity to Light (ISO Sensitivity).....	213
ISO Sensitivity.....	213
Auto ISO Sensitivity Control.....	216
Achieving Natural Colors with Different Light Sources (White Balance).....	221
White Balance.....	221
Fine-Tuning White Balance.....	227
Choosing a Color Temperature.....	231
Preset Manual.....	234
Varying Exposure or White Balance over a Series of Photographs (Bracketing).....	249
Bracketing.....	250
Exposure and Flash Bracketing.....	251
White Balance Bracketing.....	259
ADL Bracketing.....	265

Image Processing (Picture Controls) .....	271
Picture Controls .....	271
Modifying Picture Controls from the Menus.....	274
Custom Picture Controls.....	276
Preserving Detail in Highlights and Shadows	
(Active D-Lighting and HDR) .....	281
Active D-Lighting .....	281
High Dynamic Range (HDR).....	283
<b>Movie Recording and Editing</b>	<b>292</b>
<hr/>	
Image Area: Choosing a Movie Crop.....	292
Frame Size/Frame Rate and Movie Quality.....	294
The Movie Crop.....	296
Points to Note When Recording Movies.....	297
Editing Movies.....	300
Trimming Movies.....	301
Saving Selected Frames as JPEG Stills.....	306
Adding Indices to Movies .....	307
<b>Other Shooting Options</b>	<b>308</b>
<hr/>	
Using Two Memory Cards .....	308
Deleting Copies.....	311

Two-Button Reset: Restoring Default Settings.....	312
Photo Shooting Menu.....	313
Movie Shooting Menu .....	315
Other Settings .....	316
Combining Multiple Exposures in a Single Photo	
(Multiple Exposure) .....	318
Multiple Exposure Options.....	318
Creating a Multiple Exposure .....	321
Using the <b>i</b> Button .....	329
Ending Multiple Exposures.....	330
Taking Photos at a Set Interval (Interval Timer Shooting) ...	331
Interval Timer Shooting Options.....	331
Interval-Timer Photography .....	336
Pausing Interval-Timer Photography .....	345
Resuming Interval Timer Shooting.....	346
Ending Interval Timer Shooting .....	347
Creating a Movie from Photos (Time-Lapse Movie).....	348
Time-Lapse Movie Options .....	348
Recording Time-Lapse Movies.....	350
Varying Focus over a Series of Photos	
(Focus Shift Shooting) .....	360
Focus Shift Shooting Options.....	360
Focus Shift Photography.....	363

The Electronic Shutter (Silent Live View Photography) .....	374
Customizing the <b>i</b> Menu: Customize <b>i</b> Menu .....	377
Using Non-CPU Lenses (Non-CPU Lens Data).....	379
Entering Lens Data.....	381
Recalling Non-CPU Lens Data .....	383
Location Data .....	384
Location Data Options.....	384
<b>Playback</b> .....	<b>390</b>
<hr/>	
Viewing Pictures .....	390
Full-Frame Playback .....	390
Thumbnail Playback.....	391
Playback Controls.....	392
Playback Touch Controls .....	395
The <b>i</b> Button .....	399
Photo Information .....	405
File Information.....	406
Exposure Data.....	407
Highlights.....	407
RGB Histogram .....	408
Shooting Data.....	410
Overview.....	416
Playback Zoom.....	418
Using Playback Zoom .....	419

Protecting Pictures from Deletion.....	421
Rating Pictures.....	423
Selecting Pictures for Upload.....	425
Filtered Playback.....	427
[Filtered Playback Criteria].....	427
Deleting Pictures.....	429
Using the Delete Button.....	429
Deleting Multiple Pictures.....	431
<b>Voice Memos</b>	<b>436</b>
<hr/>	
Recording Voice Memos.....	436
During Playback.....	436
During Shooting.....	438
Playing Voice Memos.....	443
Deleting Voice Memos.....	444
<b>Connecting to Computers and TVs</b>	<b>445</b>
<hr/>	
Connecting to Computers.....	445
Connecting via USB.....	445
Ethernet and Wireless Networks (Wi-Fi).....	451
Connecting to HDMI Devices.....	453
TVs.....	454
Recorders.....	454

---

Camera and Network System Chart .....	457
Connecting to Smart Devices .....	458
The SnapBridge App .....	458
What SnapBridge Can Do for You .....	459
Wireless Connections.....	460
Connecting via Wi-Fi (Wi-Fi Mode) .....	461
Connecting via Bluetooth .....	469
Connecting to Computers via Wi-Fi .....	485
What Wi-Fi Can Do for You .....	485
The Wireless Transmitter Utility .....	485
Infrastructure and Access-Point Modes .....	486
Connecting in Access-Point Mode.....	488
Connecting in Infrastructure Mode .....	494
Uploading Pictures .....	503
Disconnecting and Reconnecting.....	510
Troubleshooting Built-in Wi-Fi .....	512



---

Ethernet Connections and the WT-6 .....	514
The Wireless Transmitter Utility.....	515
What Ethernet and the WT-6 Can Do for You.....	516
Upload to FTP Servers or Computers .....	516
Computer-Based Remote Photography (Camera Control Mode) .....	517
Browser-Based Remote Photography (HTTP Server Mode).....	517
Camera-Based Remote Photography (Synchronized Release) .....	518
Clock Synchronization (Synchronize Date and Time) .....	518
Connecting an Ethernet Cable or WT-6.....	520
Connecting an Ethernet Cable.....	520
Attaching the WT-6 .....	521
Creating a Network Profile (Ethernet) .....	522
Image Transfer and Camera Control Modes .....	523
HTTP Server Mode .....	531
FTP Upload Mode .....	536

Creating Network Profiles (WT-6) .....	544
WT-6 Wireless Connection Options .....	545
Image Transfer and Camera Control Modes.....	546
HTTP Server Mode.....	560
FTP Upload Mode .....	571
Upload to Computers and FTP Servers .....	585
Connecting to a Computer or FTP Server.....	585
Camera Control .....	595
The [Wired LAN/WT] Status Display.....	598
HTTP Server .....	601
The [Wired LAN/WT] Status Display.....	607
Computer, Android, and iPad Web Browsers....	610
iPhone Web Browsers .....	622
Synchronized Release .....	628
About Synchronized Release .....	628
Using Synchronized Release .....	629
Synchronizing Camera Clocks .....	633
Ethernet/Wireless Transmitter Troubleshooting .....	636
Problems and Solutions .....	636
Error Codes .....	638

<b>On-Camera Flash Photography</b>	<b>640</b>
<hr/>	
“On-Camera” Versus “Remote” .....	640
Camera-Mounted Flash Units.....	640
Remote Flash Photography .....	640
Using an On-Camera Flash .....	641
Flash Control Mode.....	645
Flash Modes .....	648
Choosing a Flash Mode .....	651
Flash Compensation.....	653
Adjusting Flash Compensation .....	653
FV Lock .....	655
Flash Info for On-Camera Units .....	659
Flash Control Mode Displays .....	660
<b>Remote Flash Photography</b>	<b>663</b>
<hr/>	
What Is Remote Flash Photography?.....	663
Using Remote Flash Units.....	664
Radio AWL .....	665
Establishing a Wireless Connection .....	665
Remote Flash Photography .....	670
Adding a Shoe-Mounted Flash Unit.....	679
Optical AWL .....	680
Using Optical AWL with the SB-5000 or SB-500 .....	681

Optical/Radio AWL.....	694
Flash Info for Remote Units .....	695
Flash Control Mode Displays.....	695
<b>Menu Guide</b> .....	<b>698</b>
<hr/>	
Defaults.....	698
Playback Menu Defaults .....	698
Photo Shooting Menu Defaults.....	700
Movie Shooting Menu Defaults .....	707
Custom Settings Menu Defaults .....	709
Setup Menu Defaults .....	722
▶ The Playback Menu: Managing Images.....	730
Delete.....	731
Playback Folder .....	732
Playback Display Options .....	733
Delete Images from Both Slots .....	734
Dual-Format Recording PB Slot.....	735
Filtered Playback Criteria .....	735
Image Review.....	735
After Delete.....	736
After Burst, Show .....	737
Rotate Tall.....	738

Copy Image(s).....	738
Copying Pictures .....	739
Hide Image .....	746
Slide Show .....	748
Viewing Slide Shows.....	748
 The Photo Shooting Menu: Shooting Options .....	750
Photo Shooting Menu Bank .....	752
Renaming Photo Shooting Menu Banks .....	753
Restoring Default Settings.....	753
Extended Photo Menu Banks .....	754
Storage Folder .....	755
Renaming Folders.....	755
Select Folder by Number .....	756
Select Folder from List .....	758
File Naming .....	760
Role Played by Card in Slot 2 .....	761
Image Area .....	761
Image Quality .....	761
Image Size.....	762
NEF (RAW) Recording .....	762
NEF (RAW) Compression .....	763
NEF (RAW) Bit Depth.....	763

ISO Sensitivity Settings .....	764
White Balance .....	764
Set Picture Control .....	764
Manage Picture Control .....	765
Color Space .....	765
Active D-Lighting.....	766
Long Exposure NR .....	767
High ISO NR .....	768
Vignette Control .....	769
Diffraction Compensation.....	770
Auto Distortion Control.....	771
Flicker Reduction .....	772
Flash Control .....	774
Flash Control Mode .....	775
Wireless Flash Options .....	776
Remote Flash Control .....	777
Radio Remote Flash Info .....	777
Auto Bracketing .....	778
Multiple Exposure .....	779
HDR (High Dynamic Range).....	779
Interval Timer Shooting.....	780
Time-Lapse Movie .....	780
Focus Shift Shooting .....	780
Silent Live View Photography .....	781



 The Movie Shooting Menu: Movie Shooting Options .....	782
Reset Movie Shooting Menu.....	783
File Naming .....	783
Destination.....	783
Image Area .....	784
Auto DX Crop .....	784
Frame Size/Frame Rate .....	784
Movie Quality .....	785
Movie File Type .....	785
ISO Sensitivity Settings .....	786
White Balance.....	787
Set Picture Control.....	788
Manage Picture Control.....	788
Active D-Lighting .....	788
High ISO NR.....	789
Diffraction Compensation .....	789
Flicker Reduction.....	790
Electronic VR.....	791
Microphone Sensitivity .....	792
Attenuator .....	793
Frequency Response.....	793
Wind Noise Reduction.....	794
Headphone Volume .....	794
Timecode .....	795



 Custom Settings: Fine-Tuning Camera Settings .....	797
Custom Settings Bank.....	802
Renaming Custom Settings Banks .....	802
Restoring Default Settings .....	803
a: Autofocus.....	804
a1: AF-C Priority Selection.....	804
a2: AF-S Priority Selection .....	805
a3: Focus Tracking with Lock-On .....	805
Blocked Shot AF Response.....	806
Subject Motion.....	806
a4: Focus Points Used.....	807
a5: Store Points by Orientation .....	808
a6: AF Activation .....	810
a7: Single-Point AF Watch Area .....	811
a8: 3D-Tracking Face-Detection .....	811
a9: Group-Area AF Face Detection .....	812
a10: Custom Groupings (C1/C2).....	812
a11: Auto-Area AF Face Detection.....	812
a12: Auto-Area AF Starting Point .....	813
a13: Focus-Point Persistence .....	813
a14: Limit AF-Area Mode Selection .....	814
a15: Autofocus Mode Restrictions .....	815
a16: Focus Point Wrap-Around .....	815



a17: Focus Point Options .....	815
Manual Focus Mode.....	816
Focus Point Brightness .....	816
Dynamic-Area AF Assist.....	816
a18: Manual Focus Ring in AF Mode.....	817
b: Metering/Exposure .....	818
b1: ISO Sensitivity Step Value.....	818
b2: EV Steps for Exposure Cntrl .....	818
b3: Exp./Flash Comp. Step Value .....	818
b4: Easy Exposure Compensation .....	819
b5: Matrix Metering .....	820
b6: Center-Weighted Area .....	820
b7: Fine-Tune Optimal Exposure .....	821
c: Timers/AE Lock .....	822
c1: Shutter-Release Button AE-L .....	822
c2: Standby Timer.....	822
c3: Self-Timer.....	823
c4: Monitor Off Delay .....	823
d: Shooting/Display.....	824
d1: Continuous Shooting Speed.....	824
d2: Max. Continuous Release .....	825
d3: Limit Release Mode Selection.....	826
d4: Sync. Release Mode Options.....	826

d5: Exposure Delay Mode .....	827
d6: Electronic Front-Curtain Shutter .....	827
d7: Extended Shutter Speeds (M).....	828
d8: Limit Selectable Image Area .....	829
d9: File Number Sequence .....	830
d10: Peaking Highlights.....	832
d11: Framing Grid Display .....	832
d12: Rear Control Panel .....	833
d13: LCD Illumination .....	833
d14: Live View in Continuous Mode.....	835
d15: Optical VR.....	835
e: Bracketing/Flash .....	836
e1: Flash Sync Speed.....	836
e2: Flash Shutter Speed .....	838
e3: Exposure Comp. for Flash .....	838
e4: Auto  ISO Sensitivity Control .....	839
e5: Flash Burst Priority .....	840
e6: Modeling Flash.....	840
e7: Auto Bracketing (Mode M).....	841
e8: Bracketing Order .....	842
e9: Bracketing Burst Options .....	843

f: Controls.....	844
f1: Customize  Menu.....	844
f2: Customize  Menu (Lv).....	846
Photo Live View Display WB.....	848
Split-Screen Display Zoom.....	849
f3: Custom Controls.....	850
f4: Multi Selector Center Button.....	863
Viewfinder Photography.....	864
Live View.....	865
Playback Mode.....	866
f5: Shutter Spd & Aperture Lock.....	867
f6: Customize Command Dials.....	867
Reverse Rotation.....	868
Change Main/Sub.....	868
Aperture Setting.....	869
Menus and Playback.....	870
Sub-Dial Frame Advance.....	871
f7: Multi Selector.....	872
f8: Release Button to Use Dial.....	872
f9: Reverse Indicators.....	873
f10: Live View Button Options.....	874
f11:  Switch.....	874
f12: Full-Frame Playback Flicks.....	875
Flick Up/Flick Down.....	875
Flick Advance Direction.....	876

g: Movie.....	877
g1: Customize  Menu .....	877
Multi-Selector Power Aperture.....	878
Multi Selector Exposure Comp.....	878
g2: Custom Controls .....	879
g3: Multi Selector Center Button.....	884
g4: Highlight Display .....	884
Display Pattern .....	885
Highlight Display Threshold.....	885
 The Setup Menu: Camera Setup .....	886
Format Memory Card .....	887
Language.....	888
Time Zone and Date .....	889
Monitor Brightness .....	889
Monitor Color Balance .....	890
Virtual Horizon.....	892
Information Display .....	893
AF Fine-Tuning Options .....	894
Creating and Saving Fine-Tuning Values .....	897
Choosing a Default Fine-Tuning Value.....	899
Auto AF Fine-Tuning .....	900
Non-CPU Lens Data.....	904

Clean Image Sensor.....	905
Lock Mirror Up for Cleaning.....	906
Image Dust Off Ref Photo .....	906
Acquiring Image Dust Off Reference Data .....	907
Pixel Mapping.....	910
Image Comment .....	911
Input Comment .....	911
Attach Comment.....	912
Copyright Information .....	912
Artist/Copyright .....	913
Attach Copyright Information.....	913
IPTC .....	914
Renaming, Editing, and Copying Presets.....	915
Deleting Presets .....	915
Embedding Presets .....	916
Copying Presets to a Memory Card.....	916
Copying Presets to the Camera .....	917
Voice Memo Options .....	920
Voice Memo .....	920
Voice Memo Overwrite .....	921
Voice Memo Control.....	921
Audio Output .....	922

Beep Options.....	923
Beep On/Off.....	923
Volume .....	924
Pitch .....	924
Touch Controls .....	924
Enable/Disable Touch Controls.....	924
Glove Mode .....	924
HDMI .....	925
Location Data (Built-In).....	925
Wireless Remote (WR) Options .....	925
LED Lamp .....	926
Link Mode.....	926
Assign Remote (WR) Fn Button .....	928
Airplane Mode .....	929
Connect to Smart Device .....	929
Pairing (Bluetooth).....	930
Select to Send (Bluetooth) .....	930
Wi-Fi Connection.....	931
Send While Off.....	932
Location Data (Smart Device) .....	932
Connect to PC (Built-in Wi-Fi).....	932
Wi-Fi Connection .....	932
Network Settings.....	933
Options.....	935
MAC Address.....	936

Wired LAN/WT .....	937
Wired LAN/WT Functions.....	937
Choose Hardware .....	937
Network Settings .....	938
Options .....	945
Conformity Marking .....	949
Battery Info .....	950
Slot Empty Release Lock.....	951
Save/Load Menu Settings .....	952
Save Menu Settings.....	956
Load Menu Settings .....	956
Reset All Settings.....	957
Firmware Version .....	957
<input checked="" type="checkbox"/> The Retouch Menu: Creating Retouched Copies .....	958
Creating Retouched Copies .....	959
NEF (RAW) Processing: Converting NEF (RAW)	
to JPEG.....	962
Trim .....	967
Resize .....	968
Resizing Multiple Pictures.....	968
D-Lighting.....	973
Red-Eye Correction.....	974
Straighten .....	975

Distortion Control.....	976
Perspective Control .....	978
Monochrome .....	979
Image Overlay.....	980
Add .....	980
Lighten and Darken.....	985
Trim Movie .....	989
☰ My Menu/☰ Recent Settings.....	990
☰ My Menu: Creating a Custom Menu .....	990
☰ Recent Settings: Accessing Recently- Used Settings .....	997
<b>Troubleshooting</b>	<b>998</b>
<hr/>	
Before Contacting Customer Support.....	998
Problems and Solutions.....	1000
Battery/Display.....	1000
Shooting .....	1002
Playback.....	1009
Bluetooth and Wi-Fi (Wireless Networks) .....	1011
Miscellaneous .....	1011
Alerts and Error Messages.....	1012
Alerts .....	1012
Error Messages .....	1017



---

Camera Displays.....	1021
The Viewfinder.....	1021
The Information Display.....	1026
Live View (Still Photography/Movies) .....	1029
The Top Control Panel .....	1033
The Rear Control Panel .....	1036
Compatible F Mount Lenses.....	1037
CPU lenses .....	1037
Non-CPU lenses and Other Accessories .....	1045
The Electronic Rangefinder .....	1049
Compatible Flash Units .....	1051
The Nikon Creative Lighting System (CLS) .....	1051
Other Compatible Accessories .....	1060
Attaching a Power Connector and AC Adapter .....	1069
Software .....	1071
Caring for the Camera.....	1073
Storage .....	1073
Cleaning .....	1073
The Low-Pass Filter.....	1075
Replacing the Clock Battery.....	1083

Caring for the Camera and Battery: Cautions .....	1085
Camera Care .....	1085
Battery Care .....	1089
Using the Charger .....	1092
Exposure Program .....	1093
Specifications.....	1094
Nikon D6 Digital Camera .....	1094
Calibrating Batteries.....	1114
Approved Memory Cards .....	1119
Memory Card Capacity.....	1120
[FX (36 × 24)] Selected for Image Area .....	1120
[DX (24 × 16)] Selected for Image Area .....	1122
Battery Endurance .....	1125
Location Data (GPS/GLONASS) .....	1128
Trademarks and Licenses .....	1129
Index .....	1137

## Menu List

The camera offers the following menus. For a more complete description of individual menu items, refer to the “Menu Guide” chapter in the *Reference Manual*. Some items may not be displayed depending on camera settings or on the type of lens, flash unit, or other accessory attached.

<b>PLAYBACK MENU</b>	<b>PHOTO SHOOTING MENU</b>
Delete	Photo shooting menu bank
Playback folder	Extended photo menu banks
Playback display options	Storage folder
Delete images from both slots	File naming
Dual-format recording PB slot	Role played by card in Slot 2
Filtered playback criteria	Image area
Image review	Image quality
After delete	Image size
After burst, show	NEF (RAW) recording
Rotate tall	ISO sensitivity settings
Copy image(s)	White balance
Hide image	Set Picture Control
Slide show	Manage Picture Control
	Color space
	Active D-Lighting
	Long exposure NR
	High ISO NR

**PHOTO SHOOTING MENU**

Vignette control  
Diffraction compensation  
Auto distortion control  
Flicker reduction  
Flash control  
Auto bracketing  
Multiple exposure  
HDR (high dynamic range)  
Interval timer shooting  
Time-lapse movie  
Focus shift shooting  
Silent live view photography

**MOVIE SHOOTING MENU**

Reset movie shooting menu  
File naming  
Destination  
Image area  
Frame size/frame rate  
Movie quality  
Movie file type  
ISO sensitivity settings  
White balance  
Set Picture Control  
Manage Picture Control  
Active D-Lighting  
High ISO NR  
Diffraction compensation  
Flicker reduction  
Electronic VR  
Microphone sensitivity  
Attenuator  
Frequency response  
Wind noise reduction  
Headphone volume  
Timecode

**CUSTOM SETTING MENU**

Custom settings bank

**a Autofocus**

a1	AF-C priority selection
a2	AF-S priority selection
a3	Focus tracking with lock-on
a4	Focus points used
a5	Store points by orientation
a6	AF activation
a7	Single-point AF watch area
a8	3D-tracking face-detection
a9	Group-area AF face detection
a10	Custom groupings (C1/C2)
a11	Auto-area AF face detection
a12	Auto-area AF starting point
a13	Focus point persistence
a14	Limit AF-area mode selection
a15	Autofocus mode restrictions
a16	Focus point wrap-around
a17	Focus point options
a18	Manual focus ring in AF mode

**CUSTOM SETTING MENU**

b Metering/exposure

b1	ISO sensitivity step value
b2	EV steps for exposure cntrl
b3	Exp./flash comp. step value
b4	Easy exposure compensation
b5	Matrix metering
b6	Center-weighted area
b7	Fine-tune optimal exposure

c Timers/AE lock

c1	Shutter-release button AE-L
c2	Standby timer
c3	Self-timer
c4	Monitor off delay

**CUSTOM SETTING MENU**

## d Shooting/display

d1	Continuous shooting speed
d2	Max. continuous release
d3	Limit release mode selection
d4	Sync. release mode options
d5	Exposure delay mode
d6	Electronic front-curtain shutter
d7	Extended shutter speeds (M)
d8	Limit selectable image area
d9	File number sequence
d10	Peaking highlights
d11	Framing grid display
d12	Rear control panel
d13	LCD illumination
d14	Live view in continuous mode
d15	Optical VR

**CUSTOM SETTING MENU**

## e Bracketing/flash

e1	Flash sync speed
e2	Flash shutter speed
e3	Exposure comp. for flash
e4	Auto  ISO sensitivity control
e5	Flash burst priority
e6	Modeling flash
e7	Auto bracketing (mode M)
e8	Bracketing order
e9	Bracketing burst options

**CUSTOM SETTING MENU**

## f Controls

f1	Customize <b>i</b> menu
f2	Customize <b>i</b> menu (Lv)
f3	Custom controls
f4	Multi selector center button
f5	Shutter spd & aperture lock
f6	Customize command dials
f7	Multi selector
f8	Release button to use dial
f9	Reverse indicators
f10	Live view button options
f11	<b>⚙</b> : switch
f12	Full-frame playback flicks

## g Movie

g1	Customize <b>i</b> menu
g2	Custom controls
g3	Multi selector center button
g4	Highlight display

**SETUP MENU**

## Format memory card

Language

Time zone and date

Monitor brightness

Monitor color balance

Virtual horizon

Information display

AF fine-tuning options

Non-CPU lens data

Clean image sensor

Lock mirror up for cleaning

Image Dust Off ref photo

Pixel mapping

Image comment

Copyright information

IPTC

Voice memo options

Beep options

Touch controls

HDMI

Location data (built-in)

**SETUP MENU**

Wireless remote (WR) options  
Assign remote (WR) Fn button  
Airplane mode  
Connect to smart device  
Connect to PC (built-in Wi-Fi)  
Wired LAN/WT  
Conformity marking  
Battery info  
Slot empty release lock  
Save/load menu settings  
Reset all settings  
Firmware version

**RETOUCH MENU**

NEF (RAW) processing  
Trim  
Resize  
D-Lighting  
Red-eye correction  
Straighten  
Distortion control  
Perspective control  
Monochrome  
Image overlay  
Trim movie

**MY MENU**

Add items  
Remove items  
Rank items  
Choose tab



## For Your Safety

To prevent damage to property or injury to yourself or to others, read “For Your Safety” in its entirety before using this product.

Keep these safety instructions where all those who use this product will read them.

**⚠ DANGER:** Failure to observe the precautions marked with this icon carries a high risk of death or severe injury.

**⚠ WARNING:** Failure to observe the precautions marked with this icon could result in death or severe injury.

**⚠ CAUTION:** Failure to observe the precautions marked with this icon could result in injury or property damage.

### **⚠ WARNING**

**Do not use while walking or operating a vehicle.**

Failure to observe this precaution could result in accidents or other injury.

**Do not disassemble or modify this product. Do not touch internal parts that become exposed as the result of a fall or other accident.**

Failure to observe these precautions could result in electric shock or other injury.

**Should you notice any abnormalities such as the product producing smoke, heat, or unusual odors, immediately disconnect the battery or power source.**

Continued operation could result in fire, burns or other injury.

**Keep dry. Do not handle with wet hands. Do not handle the plug with wet hands.**

Failure to observe these precautions could result in fire or electric shock.

---

**Do not let your skin remain in prolonged contact with this product while it is on or plugged in.**

Failure to observe this precaution could result in low-temperature burns.

---

**Do not use this product in the presence of flammable dust or gas such as propane, gasoline or aerosols.**

Failure to observe this precaution could result in explosion or fire.

---

**Do not directly view the sun or other bright light source through the lens or camera.**

Failure to observe this precaution could result in visual impairment.

---

**Do not aim the flash or AF-assist illuminator at the operator of a motor vehicle.**

Failure to observe this precaution could result in accidents.

---

**Keep this product out of reach of children.**

Failure to observe this precaution could result in injury or product malfunction. In addition, note that small parts constitute a choking hazard. Should a child swallow any part of this product, seek immediate medical attention.

---

**Do not entangle, wrap or twist the straps around your neck.**

Failure to observe this precaution could result in accidents.

---

**Do not use batteries, chargers, or AC adapters not specifically designated for use with this product. When using batteries, chargers, and AC adapters designated for use with this product, do not:**

- **Damage, modify, forcibly tug or bend the cords or cables, place them under heavy objects, or expose them to heat or flame.**
- **Use travel converters or adapters designed to convert from one voltage to another or with DC-to-AC inverters.**

Failure to observe these precautions could result in fire or electric shock.

---

**Do not handle the plug when charging the product or using the AC adapter during thunderstorms.**

Failure to observe this precaution could result in electric shock.

---

**Do not handle with bare hands in locations exposed to extremely high or low temperatures.**

Failure to observe this precaution could result in burns, or frostbite.

---

 **CAUTION**

**Do not leave the lens pointed at the sun or other strong light sources.**

Light focused by the lens could cause fire or damage to product's internal parts. When shooting backlit subjects, keep the sun well out of the frame. Sunlight focused into the camera when the sun is close to the frame could cause fire.

---

**Turn this product off when its use is prohibited. Disable the location data feature. End location tracking. Disable wireless features when the use of wireless equipment is prohibited.**

The radio-frequency emissions produced by this product could interfere with equipment onboard aircraft or in hospitals or other medical facilities.

---

**Remove the battery and disconnect the AC adapter if this product will not be used for an extended period.**

Failure to observe this precaution could result in fire or product malfunction.

---

**Do not fire the flash in contact with or in close proximity to the skin or objects.**

Failure to observe this precaution could result in burns or fire.

---

**Do not leave the product where it will be exposed to extremely high temperatures, for an extended period such as in an enclosed automobile or in direct sunlight.**

Failure to observe this precaution could result in fire or product malfunction.

---

**Do not look directly at the AF-assist illuminator.**

Failure to observe this precaution could have adverse effects on vision.

---

**Do not transport cameras or lenses with tripods or similar accessories attached.**

Failure to observe this precaution could result in injury or product malfunction.

---

## **DANGER (Batteries)**

### **Do not mishandle batteries.**

Failure to observe the following precautions could result in the batteries leaking, overheating, rupturing, or catching fire:

- Use only rechargeable batteries approved for use in this product.
- Do not expose batteries to flame or excessive heat.
- Do not disassemble.
- Do not short-circuit the terminals by touching them to necklaces, hairpins, or other metal objects.
- Do not expose batteries or the products in which they are inserted to powerful physical shocks.
- Do not step on batteries, pierce them with nails, or strike them with hammers.

---

### **Charge only as indicated.**

Failure to observe this precaution could result in the batteries leaking, overheating, rupturing, or catching fire.

---

### **If battery liquid comes into contact with the eyes, rinse with plenty of clean water and seek immediate medical attention.**

Delaying action could result in eye injuries.

---

## **WARNING (Batteries)**

---

### **Keep batteries out of reach of children.**

Should a child swallow a battery, seek immediate medical attention.

---

### **Keep batteries out of reach of household pets and other animals.**

The batteries could leak, overheat, rupture, or catch fire if bitten, chewed, or otherwise damaged by animals.

---

### **Do not immerse batteries in water or expose to rain.**

Failure to observe this precaution could result in fire or product malfunction. Immediately dry the product with a towel or similar object should it become wet.

---

### **Discontinue use immediately should you notice any changes in the batteries, such as discoloration or deformation. Cease charging EN-EL18c rechargeable batteries if they do not charge in the specified period of time.**

Failure to observe these precautions could result in the batteries leaking, overheating, rupturing, or catching fire.

---

### **When batteries are no longer needed, insulate the terminals with tape.**

Overheating, rupture, or fire may result should metal objects come into contact with the terminals.

---

### **If battery liquid comes into contact with a person's skin or clothing, immediately rinse the affected area with plenty of clean water.**

Failure to observe this precaution could result in skin irritation.

---

## **DANGER (CR1616 Lithium Watch Batteries)**

### **Do not mishandle batteries.**

Failure to observe the following precautions could result in the battery leaking, overheating, rupturing, or catching fire:

- Do not attempt to recharge the battery.
- Do not expose batteries to flame or excessive heat.
- Do not disassemble.
- Do not short-circuit the terminals by touching them to necklaces, hairpins, or other metal objects.
- Do not expose batteries or the products in which they are inserted to powerful physical shocks.

---

### **If battery liquid comes into contact with the eyes, rinse with plenty of clean water and seek immediate medical attention.**

Delaying action could result in eye injuries.

---



## **WARNING (CR1616 Lithium Watch Batteries)**

---

### **Keep batteries out of reach of children.**

Should a child swallow a battery, seek immediate medical attention.

---

### **Do not immerse batteries in water or expose to rain.**

Failure to observe this precaution could result in fire or product malfunction. Immediately dry the product with a towel or similar object should it become wet.

---

### **Discontinue use immediately should you notice any changes in the battery, such as discoloration or deformation.**

Failure to observe this precaution could result in the battery leaking, overheating, rupturing, or catching fire.

---

### **Insert the battery in the correct orientation.**

Failure to observe this precaution could result in the battery leaking, overheating, rupturing, or catching fire.

---

### **When batteries are no longer needed, insulate the terminals with tape.**

Overheating, rupture, or fire may result should metal objects come into contact with the terminals.

---

### **If battery liquid comes into contact with a person's skin or clothing, immediately rinse the affected area with plenty of clean water.**

Failure to observe this precaution could result in skin irritation.

---



## Notices

- No part of the manuals included with this product may be reproduced, transmitted, transcribed, stored in a retrieval system, or translated into any language in any form, by any means, without Nikon's prior written permission.
- Nikon reserves the right to change the appearance and specifications of the hardware and software described in these manuals at any time and without prior notice.
- Nikon will not be held liable for any damages resulting from the use of this product.
- While every effort has been made to ensure that the information in these manuals is accurate and complete, we would appreciate it were you to bring any errors or omissions to the attention of the Nikon representative in your area (address provided separately).

## ● **Notice Concerning Prohibition of Copying or Reproduction**

Note that simply being in possession of material that has been digitally copied or reproduced by means of a scanner, digital camera, or other device may be punishable by law.

### • **Items prohibited by law from being copied or reproduced**

Do not copy or reproduce paper money, coins, securities, government bonds, or local government bonds, even if such copies or reproductions are stamped "Sample."

The copying or reproduction of paper money, coins, or securities which are circulated in a foreign country is prohibited.

Unless the prior permission of the government has been obtained, the copying or reproduction of unused postage stamps or post cards issued by the government is prohibited.

The copying or reproduction of stamps issued by the government and of certified documents stipulated by law is prohibited.

### • **Cautions on certain copies and reproductions**

The government has issued cautions on copies or reproductions of securities issued by private companies (shares, bills, checks, gift certificates, etc.), commuter passes, or coupon tickets, except when a minimum of necessary copies are to be provided for business use by a company. Also, do not copy or reproduce passports issued by the government, licenses issued by public agencies and private groups, ID cards, and tickets, such as passes and meal coupons.

### • **Comply with copyright notices**

Under copyright law, photographs or recordings of copyrighted works made with the camera cannot be used without the permission of the copyright holder. Exceptions apply to personal use, but note that even personal use may be restricted in the case of photographs or recordings of exhibits or live performances.

## ● Use Only Nikon Brand Electronic Accessories

Nikon cameras are designed to the highest standards and include complex electronic circuitry. Only Nikon brand electronic accessories (including lenses, chargers, batteries, AC adapters, and flash accessories) certified by Nikon specifically for use with this Nikon digital camera are engineered and proven to operate within the operational and safety requirements of this electronic circuitry.

The use of non-Nikon electronic accessories could damage the camera and may void your Nikon warranty. The use of third-party rechargeable Li-ion batteries not bearing the Nikon holographic seal shown at right could interfere with normal operation of the camera or result in the batteries overheating, igniting, rupturing, or leaking.



For more information about Nikon brand accessories, contact a local authorized Nikon dealer.

---

## ✔ Before Taking Important Pictures

Before taking pictures on important occasions (such as at weddings or before taking the camera on a trip), take a test shot to ensure that the camera is functioning normally. Nikon will not be held liable for damages or lost profits that may result from product malfunction.

## ✔ Life-Long Learning

As part of Nikon's "Life-Long Learning" commitment to ongoing product support and education, continually-updated information is available online at the following sites:

- **For users in the U.S.A.:** <https://www.nikonusa.com/>
- **For users in Europe and Africa:**  
<https://www.europe-nikon.com/support/>
- **For users in Asia, Oceania, and the Middle East:**  
<https://www.nikon-asia.com/>

Visit these sites to keep up-to-date with the latest product information, tips, answers to frequently-asked questions (FAQs), and general advice on digital imaging and photography. Additional information may be available from the Nikon representative in your area. See the following URL for contact information: <https://imaging.nikon.com/>

---

# Getting to Know the Camera

## Parts of the Camera

### Camera Body

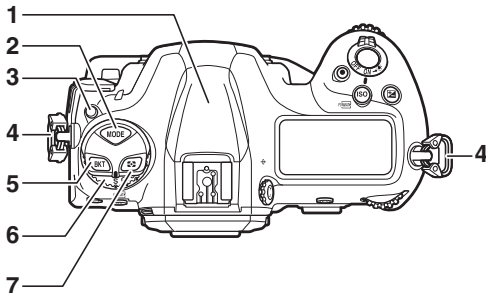





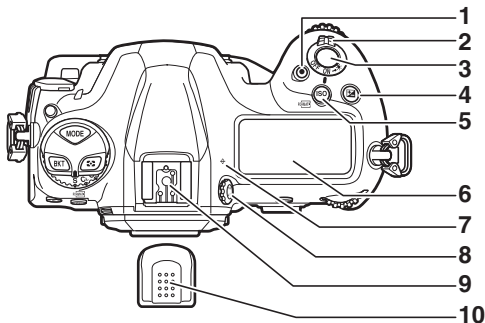



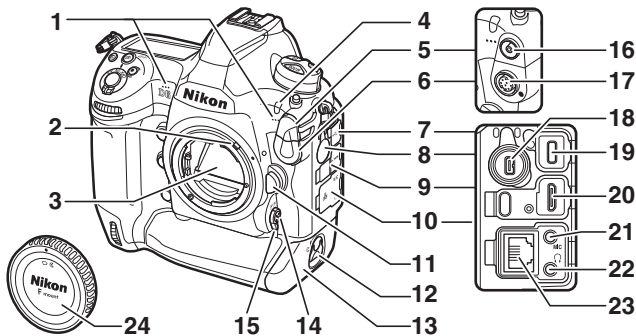







- 1 GNSS antenna (☞ 384)
- 2 **MODE** button (☞ 108)
- 3 Release mode dial lock release (☞ 109, 203)
- 4 Eyelet for camera strap (☞ 27)

- 5 **BKT** button (☞ 113, 251, 259, 265)
- 6 Release mode dial (☞ 109, 203)
- 7 **☑** button (☞ 111, 178)



- |  |  |
|--|--|
| <p><b>1</b> Movie-record button (☞ 63)</p> <p><b>2</b> Power switch (☞ 8)</p> <p><b>3</b> Shutter-release button (☞ 50)</p> <p><b>4</b> ☑ button (☞ 117, 199)</p> <p><b>5</b> <b>ISO</b> (FORMER) button (☞ 114, 213, 887)</p> <p><b>6</b> Top control panel (☞ 9, 1033)</p> | <p><b>7</b>  (focal plane mark; ☞ 177)</p> <p><b>8</b> Diopter adjustment control (☞ 14)</p> <p><b>9</b> Accessory shoe (for optional flash unit; ☞ 641)</p> <p><b>10</b> Accessory shoe cover (☞ 1066)</p> |
|--|--|



- |  |  |
|--|--|
| <p><b>1</b> Stereo microphone (for movies;  63)</p> <p><b>2</b> Meter coupling lever</p> <p><b>3</b> Mirror ( 63, 1078)</p> <p><b>4</b> Self-timer lamp ( 209)</p> <p><b>5</b> Flash sync terminal cover</p> <p><b>6</b> Ten-pin remote terminal cover</p> <p><b>7</b> USB connector cover</p> <p><b>8</b> Peripheral connector cover</p> <p><b>9</b> HDMI connector cover</p> <p><b>10</b> Cover for microphone, headphone, and Ethernet connectors</p> <p><b>11</b> Lens release button ( 37)</p> <p><b>12</b> Battery-chamber cover latch ( 32)</p> | <p><b>13</b> Battery-chamber cover ( 32)</p> <p><b>14</b> AF-mode button ( 98, 152, 163)</p> <p><b>15</b> Focus-mode selector ( 97, 148, 174)</p> <p><b>16</b> Flash sync terminal ( 644)</p> <p><b>17</b> Ten-pin remote terminal</p> <p><b>18</b> Peripheral connector ( 521)</p> <p><b>19</b> USB connector ( 445)</p> <p><b>20</b> HDMI connector ( 453)</p> <p><b>21</b> Connector for external microphone ( 299)</p> <p><b>22</b> Headphone connector ( 794)</p> <p><b>23</b> Ethernet connector ( 520)</p> <p><b>24</b> Body cap ( 35)</p> |
|--|--|

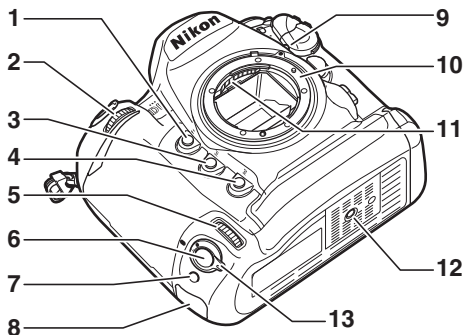

- |  |   |
|--|---|
| <p><b>1</b> P button (☞ 62, 134, 187)</p> <p><b>2</b> Sub-command dial (☞ 867)</p> <p><b>3</b> Fn1 button (☞ 135)</p> <p><b>4</b> Fn2 button (☞ 135)</p> <p><b>5</b> Sub-command dial for vertical shooting (☞ 867)</p> <p><b>6</b> Shutter-release button for vertical shooting</p> <p><b>7</b> Fn button (vertical; ☞ 135)</p> | <p><b>8</b> Security slot (for anti-theft cable; ☞ 7)</p> <p><b>9</b> Lens mounting mark (☞ 35)</p> <p><b>10</b> Lens mount (☞ 35)</p> <p><b>11</b> CPU contacts</p> <p><b>12</b> Tripod socket</p> <p><b>13</b> Vertical shooting shutter-release button lock (☞ 54)</p> |
|--|---|



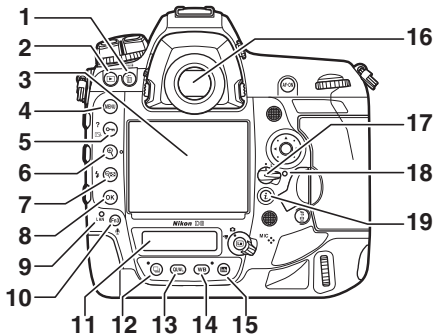

1	(FORMATS) button (☞ 76, 429, 887)	11	Rear control panel (☞ 11, 1036)
2	button (☞ 71, 390)	12	button (☞ 109, 208, 312)
3	Monitor (☞ 18, 55, 63, 395)	13	<b>QUAL</b> button (☞ 118, 144, 147)
4	<b>MENU</b> button (☞ 80, 698)	14	<b>WB</b> button (☞ 121, 221, 312)
5	(Fn/? ) button (☞ 87, 125, 273, 421)	15	button (☞ 94)
6	button (☞ 61, 418)	16	Viewfinder (☞ 14)
7	button (☞ 61, 131, 651, 653)	17	Focus selector lock (☞ 164)
8	(OK) button (☞ 81)	18	Memory card access lamp (☞ 38)
9	Network indicator (☞ 593)	19	<b>i</b> button (☞ 88, 399)
10	<b>Fn3</b> () button (☞ 135, 436)		

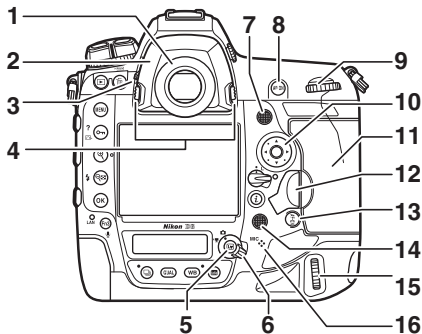

- |  |   |
|--|---|
| <p><b>1</b> Viewfinder eyepiece (📖 1067)</p> <p><b>2</b> Eyepiece adapter (📖 1067)</p> <p><b>3</b> Eyepiece shutter lever (📖 13)</p> <p><b>4</b> Eyepiece adapter latch (📖 1067)</p> <p><b>5</b> <b>Lv</b> button (📖 55, 63, 874)</p> <p><b>6</b> Live view selector (📖 55, 63)</p> <p><b>7</b> Sub-selector (📖 166, 170, 196)</p> <p><b>8</b> <b>AF-ON</b> button (📖 107, 173)</p> <p><b>9</b> Main command dial (📖 867)</p> <p><b>10</b> Multi selector (📖 81, 393)</p> <p><b>11</b> Memory card slot cover (📖 38)</p> | <p><b>12</b> Card slot cover release button cover (📖 38)</p> <p>Card slot cover release button (under cover; 📖 38)</p> <p><b>13</b> <b>Fn</b> button (📖 107)</p> <p><b>14</b> Multi selector (vertical; 📖 166)</p> <p><b>15</b> Main command dial (vertical; 📖 867)</p> <p>Speaker</p> <p><b>16</b> Microphone (for voice memos; 📖 436)</p> |
|--|---|

---

### ✓ **The GNSS Antenna**

If possible, stay in the open when using location data services. Keep the antenna pointed to the sky for best reception.

### ✓ **The Connector Covers**

Be sure to close the covers when the connectors are not in use. Foreign matter in the connectors could cause malfunction.

### ✓ **The Speaker**

Close proximity to the speaker could corrupt data stored on magnetic stripe cards or other such magnetic storage devices. Keep magnetic storage devices away from the speaker.

---

### ✓ **The Security Slot**

The security slot serves as an attachment point for third-party anti-theft cables. It is compatible and intended for use with Kensington security cable locks. For more information, see the documentation provided with the security cable lock.

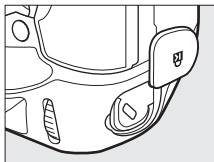

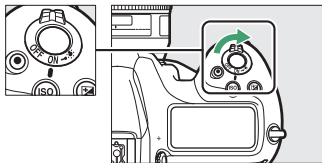

## **The Power Switch**

Rotate the power switch to the “ON” position as shown to turn the camera on. Returning the switch to the “OFF” position turns the camera off.



---

### **✓ The LCD Illuminator**

Rotating the power switch to  activates the backlights for the buttons and control panels (LCD illuminator). The backlights will remain lit for a few seconds after the power switch is released. The backlights turn off when the switch is rotated to  a second time or the shutter is released. Activating the button backlight makes the camera easier to use in the dark.

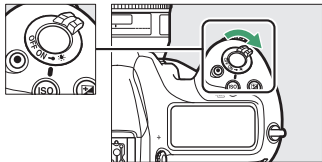

## The Top Control Panel

The following indicators appear in the top control panel at default settings. For a full list of the indicators that may be displayed, see “Camera Displays” (📖 1033) in “Technical Notes”.

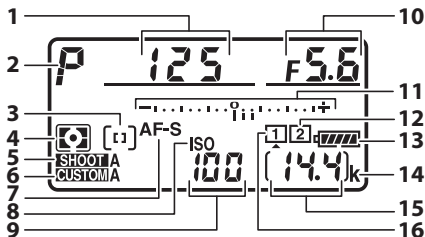

1	Shutter speed (📖 185, 188)	11	Exposure indicator Exposure (📖 190) Exposure compensation (📖 117, 199)
2	Exposure mode (📖 108, 182)	12	Memory card icon (Slot 2; 📖 41, 48)
3	AF-area mode indicator (📖 101, 163)	13	Battery indicator (📖 47)
4	Metering (📖 111, 178)	14	"k" (appears when memory remains for over 1000 exposures; 📖 48)
5	Photo shooting menu bank (📖 752)	15	Number of exposures remaining (📖 48, 1120)
6	Custom settings bank (📖 802)	16	Memory card icon (Slot 1; 📖 41, 48)
7	Autofocus mode (📖 98, 149)		
8	ISO sensitivity indicator (📖 114, 213)		
9	ISO sensitivity (📖 114, 213)		
10	Aperture (f-number; 📖 186, 188)		

---

### ✔ Camera Off Display

If the camera is turned off with a battery and memory card inserted, the memory card icon, the number of photos in the current folder (①), and the number of exposures remaining (②) will be displayed in the top control panel. Depending on the memory card, the camera may in rare cases not display this information when a card is inserted. This can be addressed by turning the camera on.

---

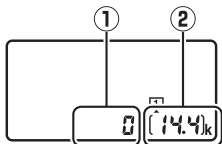

## The Rear Control Panel

The following indicators appear in the rear control panel at default settings. For a full list of the indicators that may be displayed, see “Camera Displays” (📖 1036) in “Technical Notes”.

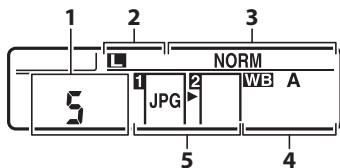

**1** Release mode (📖 109, 203)

**2** Size (JPEG images; 📖 120, 145)

**3** Image quality (📖 118, 144)

**4** White balance (📖 121, 221)

**5** Role played by memory card  
in Slot 2 (📖 308)  
Image quality (📖 118, 144)

## The Viewfinder

The following indicators appear in the viewfinder at default settings. For a full list of the indicators that may be displayed, see “Camera Displays” (📖 1021) in “Technical Notes”.

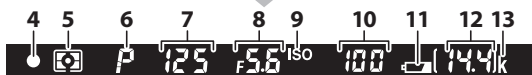
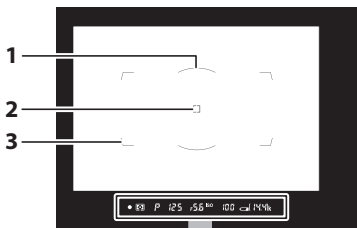

1	12-mm reference circle for center-weighted metering (📖 111, 178)	9	ISO sensitivity indicator (📖 114, 213)
2	Focus points (📖 164)	10	ISO sensitivity (📖 114, 213) AF-area mode (📖 101, 157)
3	AF-area brackets (📖 50, 164)	11	Battery indicator (📖 47)
4	Focus indicator (📖 50, 176)	12	Number of exposures remaining (📖 48, 1120) Number of shots remaining before memory buffer fills (📖 207, 1120)
5	Metering (📖 111, 178)	13	“k” (appears when memory remains for over 1000 exposures; 📖 48)
6	Exposure mode (📖 108, 182)		
7	Shutter speed (📖 185, 188) Autofocus mode (📖 98, 149)		
8	Aperture (f-number; 📖 186, 188)		



---

### ✓ **The Viewfinder**

When the battery is exhausted or no battery is inserted, the display in the viewfinder will dim. The display will return to normal when a charged battery is inserted.

### ✓ **Temperature Extremes**

The brightness of the control panel and viewfinder displays varies with temperature, and response times may drop when the temperature is low; the displays will return to normal at room temperature.

### ✓ **The Viewfinder Eyepiece Shutter**

To prevent light entering via the viewfinder interfering with photographs or exposure, raise the viewfinder eyepiece shutter lever to close the viewfinder eyepiece shutter when taking photos without your eye to the viewfinder.

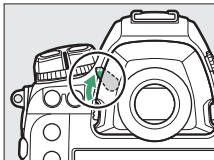

---

## ✔ The Diopter Adjustment Control

The viewfinder can be focused by lifting and rotating the diopter adjustment control. With your eye to the viewfinder, rotate the diopter control until display in the viewfinder is in sharp focus.

- Corrective lenses (available separately) can be used to further adjust viewfinder diopter.
- After adjusting diopter, push the diopter adjustment control back into its original position.

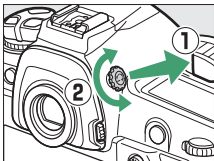

Viewfinder not in focus



Viewfinder in focus

## The Live View Displays (Photos/Movies)

Press the **[Lv]** button to display the view through the lens in the monitor. Rotate the live view selector to **[📷]** to take photographs or to **[🎥]** to record movies.

### ■ Live View Photography

The following indicators appear in the monitor at default settings. For a full list of the indicators that may be displayed, see “Camera Displays” (📖 1029) in “Technical Notes”.

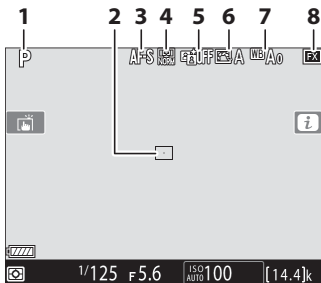

**1** Exposure mode (📖 108, 151)

**2** Focus point (📖 164)

**3** Autofocus mode (📖 98, 151)

**4** AF-area mode (📖 101, 160)

**5** Active D-Lighting (📖 281)

**6** Picture Control (📖 125, 271)

**7** White balance (📖 121, 221)

**8** Image area (📖 136)

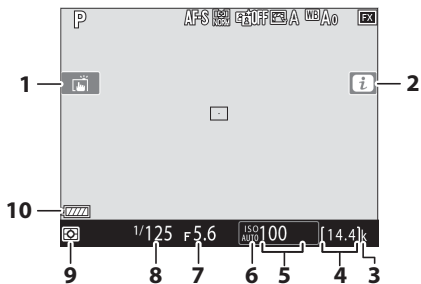

- |          |   |           |  |
|----------|---|-----------|--|
| <b>1</b> | Touch shooting (📖 18)   | <b>5</b>  | ISO sensitivity (📖 114, 213)           |
| <b>2</b> | <i>i</i> icon (📖 88)  | <b>6</b>  | ISO sensitivity indicator (📖 114, 213) |
| <b>3</b> | "k" (appears when memory remains for over 1000 exposures; 📖 48) | <b>7</b>  | Aperture (📖 186, 188)                  |
| <b>4</b> | Number of exposures remaining (📖 48, 1120)                      | <b>8</b>  | Shutter speed (📖 185, 188)             |
|          |   | <b>9</b>  | Metering (📖 111, 178)                  |
|          |   | <b>10</b> | Battery indicator (📖 47)               |

## ■ Movies

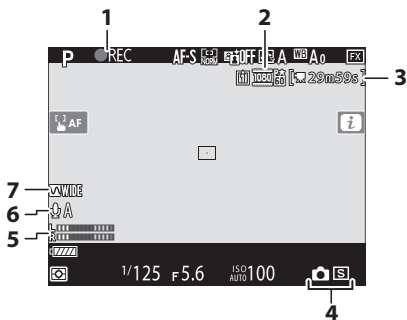

**1** Recording indicator (📖 63)  
“No movie” indicator (📖 297)

**2** Frame size and rate/image  
quality (📖 294)

**3** Time remaining (📖 63)

**4** Release mode (still  
photography; 📖 70)

**5** Sound level (📖 66)

**6** Microphone sensitivity  
(📖 792)

**7** Frequency response (📖 793)

## Touch Controls

- The touch-sensitive monitor offers a variety of controls that can be operated by touching the display with your fingers.

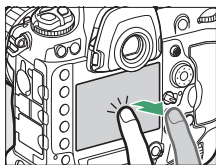

- Touch controls can be used to:
  - Focus and release the shutter (📖 19)
  - Adjust settings (📖 20)
  - View pictures (📖 21)
  - View movies (📖 23)
  - Access the **i** menu (📖 23)
  - Enter text (📖 24)
  - Navigate the menus (📖 25)

## ■ Focusing and Releasing the Shutter

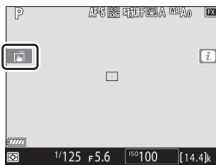
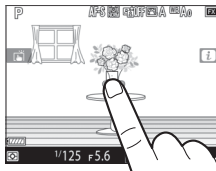

- Touch the monitor during live view to focus on the selected point (touch AF).
- During still photography, the shutter will be released when you lift your finger from the display (touch shutter).
- Touch AF settings can be adjusted by tapping the  icon.



## ■ Adjusting Settings

- Tap highlighted settings in the display.
- You can then choose the desired option by tapping icons or sliders.



- Tap  or press  to select the chosen option and return to the previous display.





## ■ Playback

- Flick left or right to view other pictures during full-frame playback.

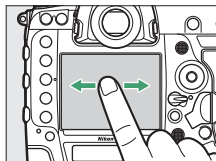

- In full-frame playback, touching the bottom of the display brings up a frame-advance bar. Slide your finger left or right over the bar to scroll rapidly to other pictures.

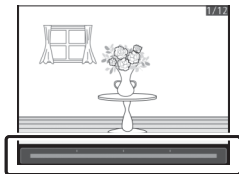
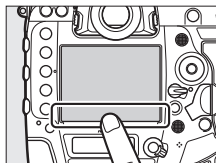

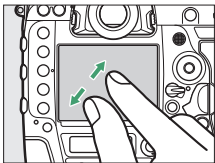

- To zoom in on a picture displayed in full-frame playback, use a stretch gesture or give the display two quick taps. After zooming in, you can adjust the zoom ratio using stretch gestures to zoom in and pinch gestures to zoom out.

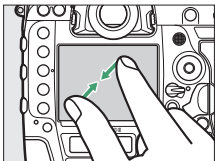

- Use slide gestures to view other parts of the image during zoom.
- Giving the display two quick taps while zoom is in effect cancels zoom.
- To “zoom out” to a thumbnail view, use a pinch gesture in full-frame playback. Use pinch and stretch to choose the number of images displayed from 4, 9, and 72 frames.



## ■ Viewing Movies

- Movies are indicated by a  icon; to start playback, tap the on-screen guide.
- Tap the display to pause. Tap again to resume.
- Tap  to exit to full-frame playback.

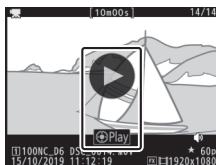

## ■ The *i* Menu

When the *i* menu ( 88) is displayed, you can tap items to view options.



## ■ Text Entry

- When a keyboard is displayed, you can enter text by tapping the keys.



- 1 Text display area
- 2 Keyboard area
- 3 Keyboard selection

- To position the cursor, tap ◀ or ▶ or tap directly in the text display area.
- To cycle through the upper- and lower-case and symbol keyboards, tap the keyboard selection button.

## ■ Navigating the Menus

- After pressing the **MENU** button to display the menus, you can slide up or down to scroll.

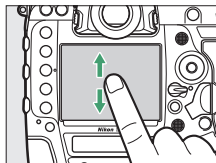

- Tap a menu icon to choose a menu.

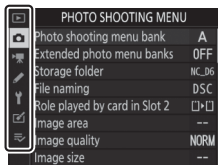

- Tap menu items to display options. You can then choose the desired option by tapping icons or sliders.

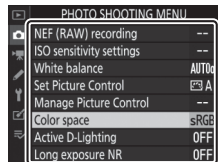

- To exit without changing settings, tap .

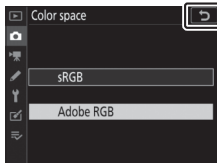

---

## ✓ The Touch Screen

- The touch screen responds to static electricity. It may not respond when touched with fingernails or gloved hands. For improved response when using the touch screen with gloves, select **[Enabled]** for **[Touch controls]** > **[Glove mode]** in the setup menu.
- Do not touch the screen with sharp objects.
- Do not use excessive force.
- The screen may not respond when covered with third-party protective films.
- The screen may not respond when touched simultaneously in multiple locations.

---

## ✓ Enabling or Disabling Touch Controls

Touch controls can be enabled or disabled using the **[Touch controls]** item in the setup menu.

---

# First Steps

## Readying the Camera

### Attaching the Strap

To attach a strap (whether the supplied strap or one that has been purchased separately):

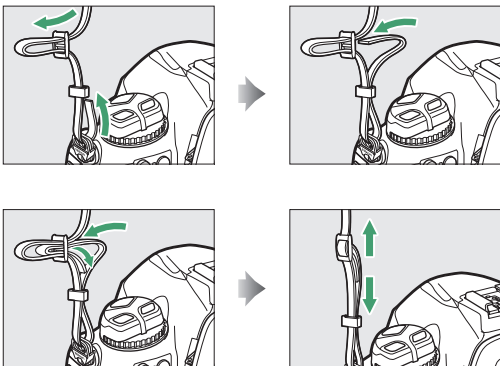

## **Charging the Battery**

Charge the supplied EN-EL18c battery in the supplied MH-26a battery charger before use. An exhausted battery will fully charge in about two hours and 35 minutes.

### **✓ The Battery and Charger**

Read and follow the warnings and cautions in "For Your Safety" (☞ xli) and "Caring for the Camera and Battery: Cautions" (☞ 1085).

#### **1 Connect the power cable to the charger.**

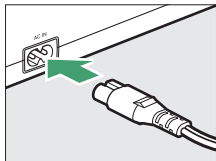

#### **2 Plug the charger in.**

#### **3 Remove the battery terminal cover.**

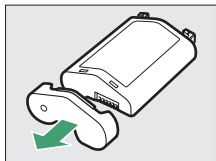



## 4 Remove the contact protector.

Slide the contact protector from the charger as shown.

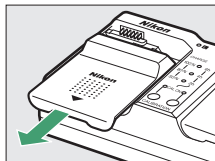

## 5 Charge the battery.

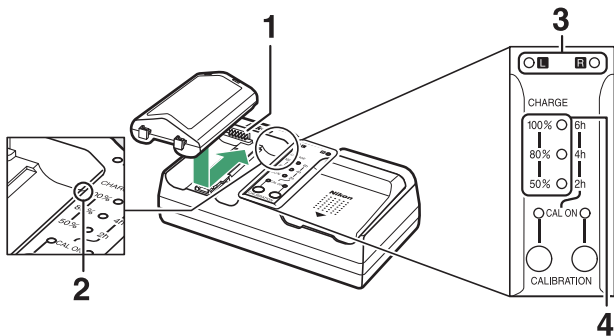

- 1 Contacts
- 2 Guide
- 3 Chamber lamps
- 4 Charge lamps (green)

- Insert the battery (terminals first), aligning the end of the battery with the guide and then sliding the battery in the direction indicated until it clicks into place.
- The lamp for the chamber containing the battery (“L” or “R”) will start to flash as charging begins.
- Charging is complete when the chamber lamp stops flashing and the charge lamps turn off.
- Battery status is shown by the chamber and charge lamps:

		Charge state			
		<50%	≥50%, <80%	≥80%, <100%	100%
<b>Chamber lamp</b>		☼ (flashes)	☼ (flashes)	☼ (flashes)	○ (on)
<b>Charge lamps</b>	<b>100%</b>	● (off)	● (off)	☼ (flashes)	● (off)
	<b>80%</b>	● (off)	☼ (flashes)	○ (on)	● (off)
	<b>50%</b>	☼ (flashes)	○ (on)	○ (on)	● (off)

---

## 6 Remove the battery and unplug the charger when charging is complete.

---

### ✔ Calibration

For information on calibrating batteries to ensure the accuracy of the battery level displays, see “Calibrating Batteries” (📖 1114).

### ✔ Warning Indicators

If the MH-26a chamber and charge lamps flash on and off in sequence, take the steps described below.

- **If no battery inserted:** There is a problem with the charger. Unplug the charger and consult a Nikon-authorized service representative.
  - **If a battery is inserted:** A problem has occurred with the battery or charger during charging. Remove the battery, unplug the charger, and consult a Nikon-authorized service representative.
-

## Inserting the Battery

Turn the camera off before inserting or removing the battery.

### **1 Remove the BL-6 battery-chamber cover.**

Lift the battery-chamber cover latch, turn it to the open (⊞) position (①) and remove the battery-chamber cover (②).

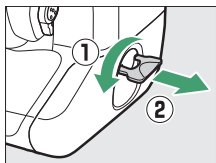

### **2 Attach the cover to the battery.**

- If the battery release is positioned so that the arrow (◀) is visible, slide the battery release to cover the arrow (◀).
- Insert the two projections on the battery into the matching slots in the cover as shown. The battery release will slide aside to completely reveal the arrow (◀).

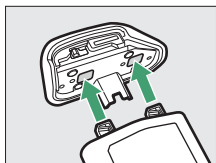
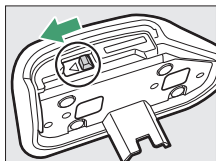

### 3 Insert the battery.

Insert the battery fully and securely as shown.

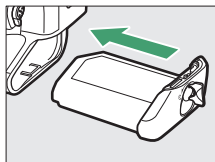

### 4 Latch the cover.

- Rotate the latch to the closed position (①) and fold it down as shown (②).

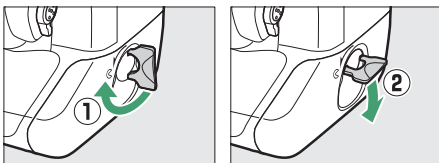

- Be sure the cover is securely latched to prevent the battery from becoming dislodged during operation.

## ■ Removing the Battery

Before removing the battery, turn the camera off, lift the battery-chamber cover latch, and turn it to the open (☞) position.

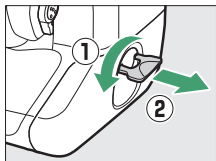

---

### ✓ Removing the Battery-Chamber Cover

To unlatch the battery-chamber cover so that it can be removed from the battery, slide the battery release in the direction indicated by the arrow (◀) until it stops.

### ✓ The Battery-Chamber Cover

- Use BL-6 battery-chamber covers only; other battery-chamber covers cannot be used with this camera.
  - The battery can be charged with the cover attached.
  - To prevent dust accumulating inside the battery chamber, replace the battery-chamber cover on the camera when the battery is not inserted.
-

## **Attaching a Lens**

- The lens generally used in this manual for illustrative purposes is an AF-S NIKKOR 50mm f/1.4G.
- Be careful to prevent dust entering the camera.
- Confirm that the camera is off before attaching the lens.
  - Remove the camera body cap (①, ②) and rear lens cap (③, ④).

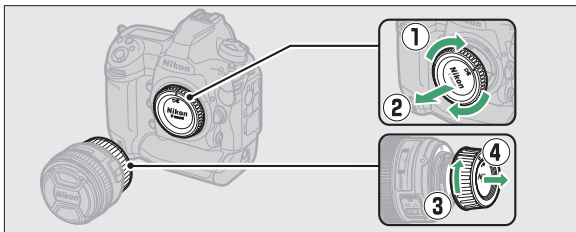

- Align the mounting marks on the camera (⑤) and lens (⑥).

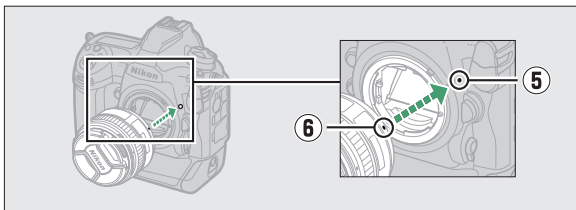

- Rotate the lens as shown until it clicks into place (7, 8).

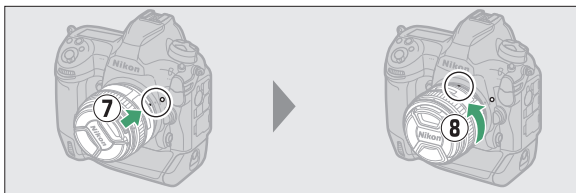

- Remove the lens cap before taking pictures.

---

### ✓ CPU Lenses with Aperture Rings

When using a CPU lens equipped with an aperture ring (🗨 1044), lock aperture at the minimum setting (highest f-number).

### ✓ Lens Focus Mode

If the lens is equipped with a focus mode switch, select autofocus mode (**A**, **M/A**, or **A/M**).



### ✓ Image Area

The DX format image area is automatically selected when a DX lens is attached.





## ■ Detaching Lenses

- After turning the camera off, press and hold the lens release button (①) while turning the lens in the direction shown (②).
- After removing the lens, replace the lens caps and camera body cap.

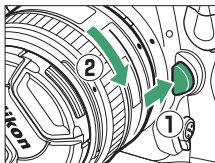

## Inserting Memory Cards

The camera is equipped with two memory card slots: Slot 1 (①) and Slot 2 (②), allowing simultaneous use of two memory cards.

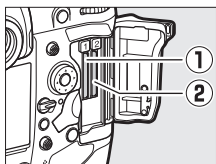

- Turn the camera off before inserting or removing memory cards.
- Do not push on the memory card while pressing the eject button. Failure to observe this precaution could damage the camera or memory card.

### **1** Open the card slot cover.

Open the door protecting the card-slot cover release button (①) and press the release button (②) to open the card slot (③).

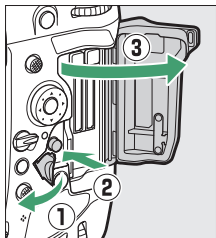

---

## 2 Insert the memory card.

*Inserting a card upside down or backwards could damage the camera or the card. Check to be sure that the card is in the correct orientation.*

Holding the card with the rear label toward the monitor, slide it all the way into the slot. When the memory card is fully inserted, the eject button (①) will pop up and the green memory card access lamp (②) will light briefly.

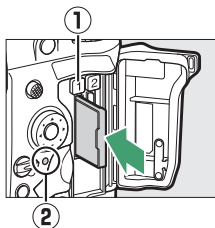

---

## 3 Close the card slot cover.

If this is the first time the memory card will be used after being used or formatted in another device, format the card in the camera before proceeding.

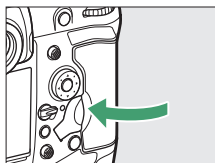

---

## ✔ Two Memory Cards

When two memory cards are inserted (one in each of Slots 1 and 2), the role played by the card in Slot 2 can be selected using **[Role played by card in Slot 2]** in the photo shooting menu.

- **[Overflow]**: Pictures will be recorded to the card in Slot 2 only when the card in Slot 1 is full.
- **[Backup]**: Two identical copies are recorded, one to each memory card and each with the same image quality and size.
- **[RAW Slot 1 - JPEG Slot 2]**: The NEF (RAW) copies of photos taken at settings of NEF (RAW) + JPEG are recorded only to the card in Slot 1, the JPEG copies only to the card in Slot 2.
- **[JPEG Slot 1 - JPEG Slot 2]**: Two JPEG copies are recorded, one to each memory card, but at different sizes.

---

## ■ Removing Memory Cards

After confirming that the memory card access lamp is off, turn the camera off and open the memory card slot cover. Press the eject button (①) to partially eject the card (②); the memory card can then be removed by hand.

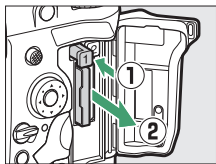

## ✔ Memory Cards

- Memory cards may be hot after use. Observe due caution when removing memory cards from the camera.
- Do not perform the following operations during formatting or while data are being recorded, deleted, or copied to a computer or other device. Failure to observe these precautions could result in loss of data or in damage to the camera or card.
  - Do not remove or insert memory cards
  - Do not turn the camera off
  - Do not remove the battery
  - Do not disconnect AC adapters
- Do not touch the card terminals with your fingers or metal objects.
- Do not use excessive force when handling memory cards. Failure to observe this precaution could damage the card.
- Do not bend or drop memory cards or subject them to strong physical shocks.
- Do not expose memory cards to water, heat, or direct sunlight.
- Do not format memory cards in a computer.

## ✔ Memory Card Icons

The memory card icons in the top control panel light when memory cards are inserted (the example in the illustration shows the display when two memory cards are inserted). If the memory card is full or an error has occurred, the icon for the affected card will flash.

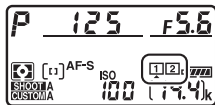

## ✔ No Memory Card Inserted

If no memory card is inserted, the exposure count displays in the viewfinder and top control panel will show (-E-). If the camera is turned off with a battery and no memory card inserted, (-E-) will be displayed in the top control panel.



## Camera Setup

The language option in the setup menu is automatically highlighted the first time menus are displayed. Choose a language and set the camera clock.

### 1 Turn the camera on.

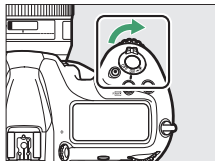

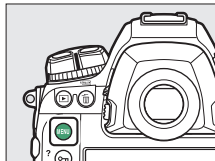

### 2 Highlight [Language] in the setup menu and press .



- The **[Language]** item is automatically highlighted in the setup menu the first time the **MENU** button is pressed after purchase.
- For information on using the menus, see “Using the Menus” (📖 81).



### 3 Select a language.

Press  or  to highlight the desired language and press  (the languages available vary with the country or region in which the camera was originally purchased).

### 4 Highlight [Time zone and date] and press .

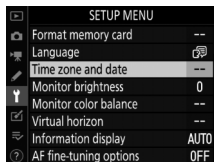

### 5 Choose a time zone.

- Select [**Time zone**] in the [**Time zone and date**] display.
- Highlight a time zone in the [**Time zone**] display and press .
- The display shows a time zone map listing the selected cities in the chosen zone and the difference between the time in the chosen zone and UTC.

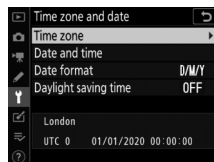



## 6 Turn daylight saving time on or off.

- Select [**Daylight saving time**] in the [**Time zone and date**] display.
- Highlight [**On**] (daylight saving time on) or [**Off**] (daylight saving time off) and press **OK**.
- Selecting [**On**] advances the clock one hour; to undo the effect, select [**Off**].

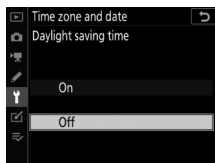

## 7 Set the clock.

- Select [**Date and time**] in the [**Time zone and date**] display.
- Press **OK** after using the multi-selector to set the clock to the date and time in the selected time zone (note that the camera uses a 24-hour clock).

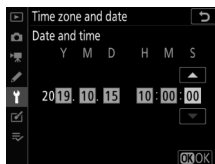

## 8 Choose a date format.

- Select [**Date format**] in the [**Time zone and date**] display.
- Highlight the desired date (year, month, and day) display order and press **OK**.

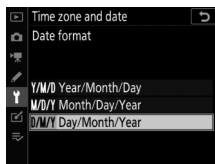

---

## 9 Exit the menus.

Lightly press the shutter-release button halfway to exit to shooting mode.



---

### ✓ The Clock Battery

The camera clock is powered by a separate, non-rechargeable CR1616 lithium battery with a life of about two years. When this battery is low, a  icon will be displayed in the top control panel while the standby timer is on, indicating that it is time to purchase a replacement. For information on replacing the clock battery, see “Replacing the Clock Battery” (📖 1083).

---

### ✓ Setting the Clock via GNSS

To record your location and the current UTC (Universal Coordinated Time), select **[On]** for **[Location data (built-in)]** > **[Record location data]**. To set the camera clock to the time supplied by the built-in GNSS receiver, select **[Yes]** for **[Location data (built-in)]** > **[Set clock from satellite]**.

### ✓ SnapBridge

Use the SnapBridge app to synchronize the camera clock with the clock on a smartphone or tablet (smart device). See SnapBridge online help for details.



# The Battery Level and Number of Exposures Remaining

Before taking photographs, check the battery level and number of exposures remaining.

## Battery Level

Check the battery level before taking photographs. The battery level is shown in the top control panel and viewfinder.

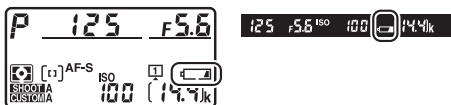

Top control panel	Viewfinder	Description
	—	Battery fully charged.
	—	Battery partially discharged.
	—	
	—	
		Low battery. Charge battery or ready spare battery.
 (flashes)	 (flashes)	Shutter release disabled. Charge or exchange battery.

## Memory Card Indicators and Number of Exposures Remaining

The top control panel and viewfinder show the number of additional photographs that can be taken at current settings (i.e, the number of exposures remaining).



- The top control panel shows the slot or slots that currently hold a memory card (the example shows the icons displayed when cards are inserted in both slots).
- At default settings, **[Overflow]** is selected for **[Role played by card in Slot 2]** in the photo shooting menu. When two memory cards are inserted, pictures will first be recorded to the card in Slot 1, switching to Slot 2 when the card in Slot 1 is full.

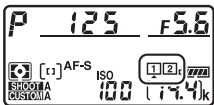

- If two memory cards are inserted, the camera will show the number of additional photographs that can be recorded to the card in Slot 1. When the card in Slot 1 is full, the display will show the number of exposures remaining on the card in Slot 2.
- Values over 1000 are rounded down to the nearest hundred. For example, values in the vicinity of 1400 are shown as 1.4 k.
- If the memory card is full or a card error has occurred, the icon for the affected slot will flash.

# Basic Photography and Playback

## Taking Photographs

Photographs can be framed in the viewfinder (viewfinder photography) or in the monitor (live view photography).

### Framing Photographs in the Viewfinder (Viewfinder Photography)

---

#### 1 Ready the camera.

Holding the handgrip in your right hand and cradling the camera body or lens with your left, bring your elbows in against the sides of your chest.



## 2 Frame the photograph.

- Frame a photograph in the viewfinder.
- Position the main subject in the AF-area brackets.

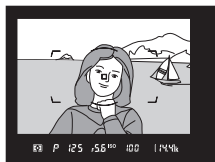

## 3 Press the shutter-release button halfway to focus.

- The in-focus indicator (●) will appear in the viewfinder when the focus operation is complete.

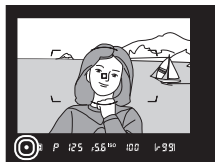

Viewfinder display	Description
● (steady)	The subject is in focus.
▶ (steady)	The focus point is in front of the subject.
◀ (steady)	The focus point is behind the subject.
▶ ◀ (flashes)	The camera is unable to focus using autofocus.

- You can also focus by pressing the **AF-ON** button.

---

**4 Smoothly press the shutter-release button the rest of the way down to take the photograph.**

The memory card access lamp will light while the photograph is being recorded. *Do not eject the memory card or remove or disconnect the power source until the lamp has gone out and recording is complete.*

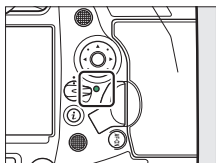



## The Standby Timer (Viewfinder Photography)

The camera uses a standby timer to help reduce the drain on the battery. The timer starts when the shutter-release button is pressed halfway and expires if no operations are performed for about 6 seconds. The viewfinder display and the shutter speed and aperture indicators in the top control panel turn off when the timer expires. To restart the timer and restore the displays, press the shutter-release button halfway a second time. The length of time before the standby timer expires can be adjusted using Custom Setting c2 [Standby timer].

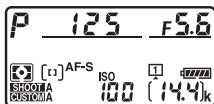

Standby timer on

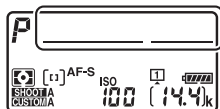

Standby timer off

## ✔ Framing Photos in Portrait (“Tall”) Orientation

The camera is equipped with controls for use in portrait (“tall”) orientation, including vertical shutter-release, **Fn**, and **AF-ON** buttons, main and sub-command dials, and a multi selector.



- Rotate the vertical shooting shutter-release button lock to **L** to avoid accidentally operating these controls when the camera is in landscape (“wide”) orientation.

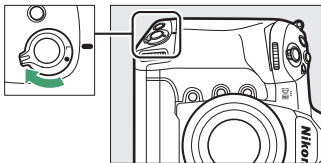

## Framing Photographs in the Monitor (Live View)

- 1 Rotate the live view selector to  (live view photography).**

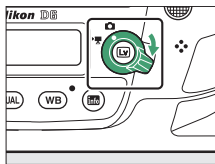

- 2 Press the  button.**

- The mirror will be raised and live view will start. The viewfinder will go dark and the view through the lens will be displayed in the monitor.
- During live view, exposure for movies and photographs can be previewed in the monitor.

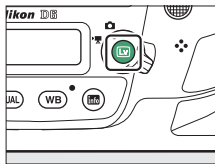

---

### 3 Ready the camera.

Hold the handgrip securely in your right hand and cradle the camera body or lens with your left.



---

### 4 Frame the photograph.

Position the subject near the center of the frame.

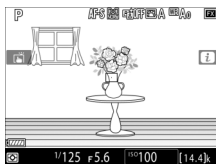

## 5 Press the shutter-release button halfway to focus.



- Focus locks while the shutter-release button is pressed halfway.
- If the camera is able to focus, the focus point will be displayed in green. If the camera is unable to focus, for example because the subject is too close to the camera, the focus point will flash red.

- To preview exposure in the monitor as shown in the illustration (exposure preview), press the **OK** button. You can preview how the settings selected for shutter speed, aperture, and ISO sensitivity affect exposure during shooting. Exposure compensation can be adjusted by  $\pm 5$  EV, although only values between  $-3$  and  $+3$  EV are reflected in the preview display.

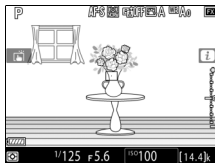

---

**6 Press the shutter-release button the rest of the way down to take the photograph.**

The monitor turns off during shooting.



---

**7 Press the  button to exit live view.**

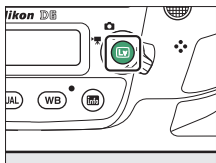

---

## ✓ Shooting in Live View

- Although these effects are not visible in the final pictures, during live view you may notice the following in the monitor:
  - Moving objects in the display appear distorted (individual subjects such as trains or cars moving at high speed through the frame may be distorted, or the entire frame may appear distorted when the camera is panned horizontally)
  - Jagged edges, color fringing, *moiré*, and bright spots may appear in the display
  - Bright regions or bands may appear in scenes lit by flashing signs and other intermittent light sources or when the subject is briefly illuminated by a strobe or other bright, momentary light source
- Flicker and banding visible in the monitor under fluorescent, mercury vapor, or sodium lamps can be reduced using the **[Flicker reduction]** item in the movie shooting menu, although they may still be visible in photographs taken at some shutter speeds.
- To prevent light entering via the viewfinder interfering with photographs or exposure, raise the viewfinder eyepiece shutter lever to close the viewfinder eyepiece shutter.
- When shooting in live view, avoid pointing the camera at the sun or other bright light sources. Failure to observe this precaution could result in damage to the camera's internal circuitry.
- Regardless of the option selected for Custom Setting c2 [**Standby timer**], the standby timer will not expire during live view.

## ✔ The Count-Down Display

A count down will appear in the top left corner of the display approximately 30 s before live view ends automatically.

- If the timer has been triggered by Custom Setting c4 [**Monitor off delay**], the count down will be displayed in black starting 30 s before the timer expires, switching to red when there are only 5 s to go. If [**No limit**] is selected for [**Monitor off delay**] > [**Live view**], the camera may nevertheless terminate live view as necessary to protect its internal circuits from high temperatures and the like.
- A count down will be displayed in red starting 30 s before the camera shuts down to protect its internal circuits. Depending on shooting conditions, the timer may appear immediately when live view is selected.

## ✔ Exposure Preview

- Exposure preview is not available when **b u l b** (Bulb) or **- -** (Time) is selected for shutter speed. The preview may not accurately reflect the final results when:
    - Flash lighting is used
    - [**Active D-Lighting**] or [**HDR (high dynamic range)**] is in effect
    - [**A**] (auto) is selected for the Picture Control [**Contrast**] parameter (☐ 128)
    - **x 25 a** is selected for shutter speed
    - Bracketing is in effect
  - If the subject is very bright or very dark, the exposure indicators will flash to warn that the preview may not accurately reflect exposure.
-





## Touch Controls

Touch controls can be used in place of the shutter-release button to focus and take pictures during live view photography (📖 19).

## Live View Zoom Preview

Press the  button to magnify the view in the monitor up to a maximum of about 11×.

- Press  to zoom in,  to zoom out.
- A navigation window will appear in a gray frame at the bottom right corner of the display.
- Use the multi selector to scroll to areas of the frame not visible in the monitor.

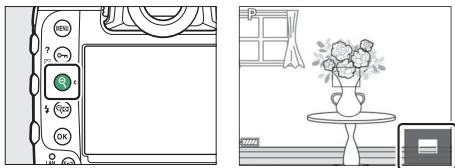

## **Previewing Focus During Live View**

To temporarily select maximum aperture for an improved focus preview during live view, press the **Pv** button. To return aperture to its original value, press the **Pv** button again or focus using autofocus. If the shutter-release button is pressed all the way down to take a picture during focus preview, aperture will return to the original value before the photo is taken. The maximum aperture icon (⊙) is displayed while maximum aperture is selected.

---

# Recording Movies

Live view can be used to record movies.

## “Filming” Versus “Recording”

Throughout this manual, the terms “filming” and “recording” are used as follows: “filming” is used if the live view selector is rotated to , while “recording” refers to the act of shooting footage using the movie-record button.

### 1 Rotate the live view selector to (movie live view).

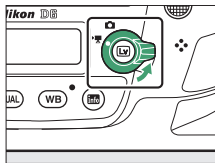

### 2 Press the button.

- The mirror will be raised and live view will start. The viewfinder will go dark and the view through the lens will be displayed in the monitor.
- During live view, exposure for movies and photographs can be previewed in the monitor.

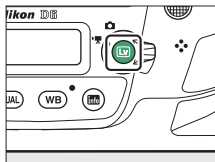

---

### 3 Press the AF-ON button to focus.

- Focus before beginning recording.
- Focus can be adjusted by tapping your subject in the monitor.

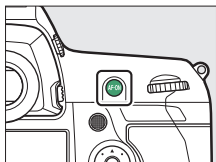

---

### 4 Press the movie-record button to start recording.

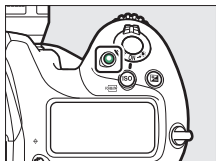

- A recording indicator will be displayed in the monitor. The monitor also shows the time remaining, or in other words the approximate amount of new footage that can be recorded to the memory card.

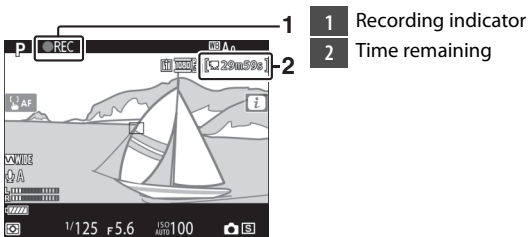

- The camera can be refocused during recording by pressing the **AF-ON** button or by tapping your subject in the monitor.
- Sound is recorded via the built-in microphone for movie recording. Do not cover the microphone during recording.
- Exposure can be altered by up to  $\pm 3$  EV using exposure compensation.

**5 Press the movie-record button again to end recording.**

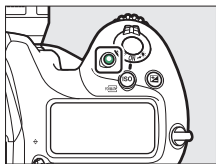

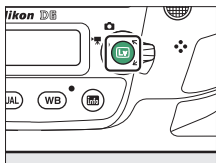

**6 Press the  button to exit live view.**



**✓ Recording Movies**

- When filming movies, you may notice the following in the display. These phenomena will also be visible in any footage recorded with the camera.
  - Flicker or banding in scenes lit by such sources as fluorescent, mercury vapor, or sodium lamps
  - Distortion associated with motion (individual subjects such as trains or cars moving at high speed through the frame may be distorted, or the entire frame may appear distorted when the camera is panned horizontally)



- Jagged edges, color fringing, *moiré*, and bright spots in the display
- Bright regions or bands in scenes lit by flashing signs and other intermittent light sources or when the subject is briefly illuminated by a strobe or other bright, momentary light source
- Flicker occurring while power aperture is in use
- Note that noise (randomly-spaced bright pixels, fog, or lines) and unexpected colors may appear if you use the  button to zoom in on the view through the lens ( 69) during filming.
- Movie recording will end automatically if:
  - The maximum length is reached
  - The live view selector is rotated to another setting
  - The lens is removed
- When recording movies, avoid pointing the camera at the sun or other strong light sources. Failure to observe this precaution could result in damage to the camera's internal circuitry.
- Sounds made by the camera may be audible in footage recorded:
  - During autofocus
  - When power aperture is used
  - During aperture adjustment
  - With vibration reduction enabled on vibration reduction (VR) lenses
- If the sound level is displayed in red, the volume is too high. Adjust microphone sensitivity.

## ✔ The Count-Down Display

A count down will appear in the top left corner of the display approximately 30 s before live view ends automatically.

- If the timer has been triggered by Custom Setting c4 [**Monitor off delay**], the count down will be displayed in black starting 30 s before the timer expires, switching to red when there are only 5 s to go. If [**No limit**] is selected for [**Monitor off delay**] > [**Live view**], the camera may nevertheless terminate live view as necessary to protect its internal circuits from high temperatures and the like.
- A count down will be displayed in red starting 30 s before the camera shuts down to protect its internal circuits. Depending on shooting conditions, the timer may appear immediately when live view is selected.
- Note that regardless of the time available (displayed in the top right corner of the monitor), live view and movie recording will end automatically when the count-down timer expires.

## ✔ Adjusting Settings During Movie Recording

- Headphone volume cannot be adjusted during recording.
  - If an option other than  (microphone off) is currently selected, microphone sensitivity can be changed while recording is in progress.  cannot be selected.
-







---

### **Focusing During Movie Recording**

Focus can also be adjusted by pressing the shutter-release button halfway.

### **Live View Zoom Preview**

Press the  button to zoom in on the view in the monitor ( 61). For a 100% zoom ratio during recording, press the  button. Press   to restore the previous zoom ratio.

---

## Taking Photos During Filming

Photos can be taken during filming by pressing the shutter-release button all the way down. The resulting photo will have an aspect ratio of 16:9.



- A  icon will flash in the display when a photo is taken.
- Photos can be taken while recording is in progress. Taking photos does not interrupt movie recording.

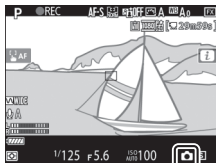

---

### ✓ Taking Photos During Filming

- Note that photos can be taken even when the subject is not in focus.
  - Photos are recorded at the dimensions currently selected for movie frame size.
  - Photos are recorded in [**JPEG fine★**] format, regardless of the option selected for image quality.
  - Photos are recorded to the card in the slot selected for [**Destination**] in the movie shooting menu.
  - The frame advance rate for continuous release modes varies with the option selected for [**Frame size/frame rate**]. While recording is in progress, only one photo will be taken each time the shutter-release button is pressed.
  - Up to 50 photographs can be taken with each movie.
  - Photographs taken during filming will not be displayed automatically after shooting even if [**On**] is selected for [**Image review**] in the playback menu.
-

# Playback

Press the  button to view photos and movies recorded with the camera.

## 1 Press the button.

- A picture will be displayed in the monitor.
- The memory card containing the picture currently displayed is shown by an icon.

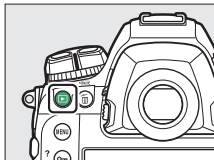

## 2 Press or to view additional pictures.

- Additional pictures can also be viewed by flicking a finger left or right over the display ( 21).
- To end playback and return to shooting mode, press the shutter-release button halfway.

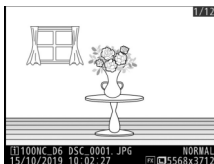



---

### **Image Review**



When **[On]** is selected for **[Image review]** in the playback menu, pictures are automatically displayed in the monitor after shooting without the user pressing the  button.

---



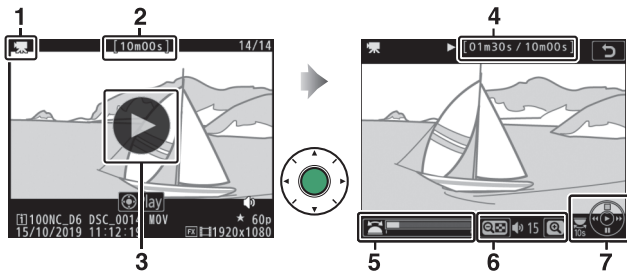









## Viewing Movies

Movies are indicated by a  icon. Tap the  icon in the display or press the center of the multi selector to start playback (a progress bar shows your approximate position in the movie).

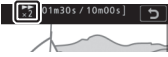
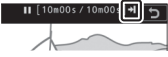

- 1  icon
- 2 Length
- 3  icon
- 4 Current position/total length
- 5 Progress bar
- 6 Volume
- 7 Guide

## ■ Movie Playback Operations

To	Description
<b>Pause</b>	Press  to pause playback.
<b>Resume</b>	Press the center of the multi selector to resume playback when playback is paused or during rewind/advance.
<b>Rewind/advance</b>	<ul style="list-style-type: none"> <li>Press  to rewind,  to advance. Speed increases with each press, from 2x to 4x to 8x to 16x.</li> <li>Keep  or  pressed to skip respectively to the first frame or last frame.</li> <li>The first frame is indicated by a  in the top right corner of the display, the last frame by a .</li> </ul>  
<b>Start slow-motion playback</b>	Press  while the movie is paused to start slow-motion playback.
<b>Jog rewind/advance</b>	<ul style="list-style-type: none"> <li>Press  or  while the movie is paused to rewind or advance one frame at a time.</li> <li>Keep  or  pressed for continuous rewind or advance.</li> </ul>
<b>Skip 10 s</b>	Rotate the main command dial one stop to skip ahead or back 10 s.
<b>Skip to last or first frame</b>	If the movie contains no indices, you can skip to the first or last frame by rotating the sub-command dial.

To	Description
<b>Skip to index</b>	If the movie contains indices, rotating the sub-command dial takes you to the next or previous index. <ul style="list-style-type: none"> <li>Indices can be added or removed from the <b>[EDIT MOVIE]</b> menu, which can be displayed by pausing playback and pressing the <b>i</b> button.</li> </ul>
<b>Adjust volume</b>	Press <b>Q</b> to increase volume, <b>Q</b> <b>⚡</b> to decrease.
<b>Trim movie</b>	To display the <b>[EDIT MOVIE]</b> menu, pause playback and press the <b>i</b> button.
<b>Exit</b>	Press <b>⏪</b> or <b>▶</b> to exit to full-frame playback.
<b>Exit to shooting mode</b>	Press the shutter-release button halfway to exit playback and return to shooting mode.

## Indices



Indices can be added when playback is paused by pressing the **i** button and selecting **[Add index]**. You can quickly jump to indexed locations during playback and editing. The presence of indices is indicated by a **i** icon in the full-frame playback display.



## Deleting Unwanted Pictures



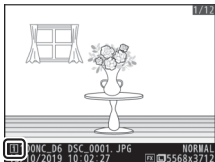
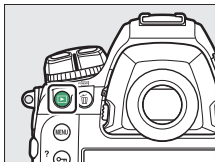

Pictures can be deleted as described below. *Note that once deleted, pictures cannot be recovered.*

### 1 Display the picture.

- Press the  button to start playback and press  or  until the desired picture is displayed.
- The location of the current image is shown by an icon at the bottom left corner of the display.



### 2 Delete the picture.

- Press the  () button; a confirmation dialog will be displayed. Press the  () button again to delete the image and return to playback.
- To exit without deleting the picture, press .

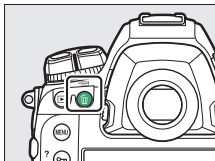



## Uploading Pictures

You can upload your pictures to smartphones or tablets (smart devices) or computers. Options for doing so are listed below. For more information, see the following in the Reference Manual: “Connecting to Computers and TVs” (📖 445), “Built-in Wireless” (📖 457), and “Ethernet/WT-6” (📖 514).

### Uploading Pictures to Smart Devices

Use the SnapBridge app to upload pictures using the camera’s built-in Wi-Fi or Bluetooth.



### Uploading Pictures to a Computer or FTP Server

Several options are available for uploading pictures to computers.

#### ■ ■ Built-in Wi-Fi

Use the camera’s built-in Wi-Fi to upload pictures to a computer via a wireless connection.



## ■ The WT-6 Wireless Transmitter

Use the optional WT-6 wireless transmitter to connect to wireless networks and upload pictures to computers or ftp servers. The WT-6 offers more reliable wireless connections than the camera's built-in Wi-Fi.



## ■ Ethernet

Connect to networks using an Ethernet cable attached to the camera's Ethernet connector and upload pictures to computers or ftp servers.



## ■ USB

Connect the camera to a computer using a USB cable and transfer pictures using the ViewNX-i computer application.

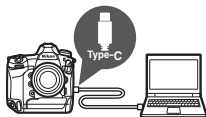

---

### ✔ **The Wireless Transmitter Utility**

You will need Wireless Transmitter Utility computer software when uploading pictures to a computer via the camera's built-in Wi-Fi, the WT-6, or an Ethernet connection.

### ✔ **The SnapBridge App and Computer Applications**

- The SnapBridge app is available from the Apple App Store® and on Google Play™.
- Nikon computer software is available from the Nikon Download Center. Check the version and system requirements and be sure to download the latest version.

<https://downloadcenter.nikonimglib.com/>

---

# Camera Controls

## The MENU Button

Press the **MENU** button to view the menus.

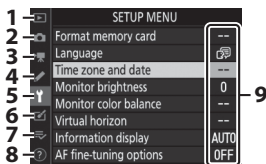
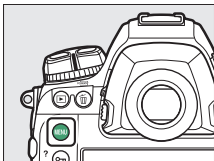

- 1 [PLAYBACK MENU]
- 2 [PHOTO SHOOTING MENU]
- 3 [MOVIE SHOOTING MENU]
- 4 [CUSTOM SETTING MENU]
- 5 [SETUP MENU]
- 6 [RETOUCH MENU]
- 7 [MY MENU] / [RECENT SETTINGS] \*
- 8 Help icon
- 9 Current settings

\* You can choose the menu displayed. The default is [MY MENU].

## Using the Menu

You can navigate the menu using the multi selector and **OK** button.

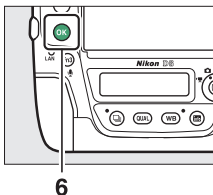
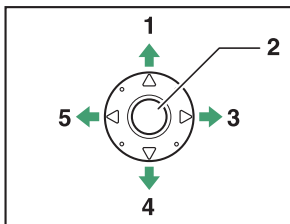

**1** Move cursor up

**2** Center of multi selector: select highlighted item

**3** Display sub-menu, select highlighted item, or move cursor right

**4** Move cursor down

**5** Cancel and return to previous menu, or move cursor left

**6** **OK** button: select highlighted item

### 1 Highlight the icon for the current menu.

Press **OK** to highlight the icon for the current menu.

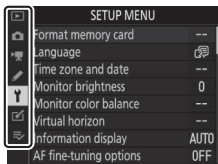

---

## 2 Select a menu.

Press  or  to select the desired menu.

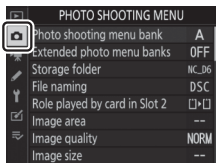

---

## 3 Position the cursor in the selected menu.

Press  to position the cursor in the selected menu.



---

## 4 Highlight a menu item.

Press  or  to highlight a menu item.

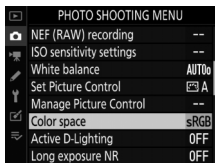

---

## 5 Display options.

Press  to display options for the selected menu item.

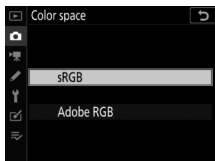

---

## 6 Highlight an option.

Press  or  to highlight an option.

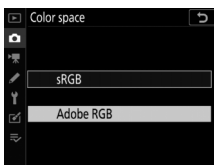

---

## 7 Select the highlighted option.

- Press .
- To exit without making a selection, press the **MENU** button.
- To exit the menus and return to shooting mode, press the shutter-release button halfway.

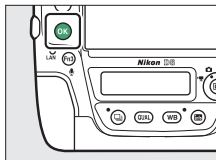



## ✓ The **OK** Button

While pressing **OK** or the center of the multi selector generally has the same effect as pressing **OK**, there are some items for which selection can only be made by pressing **OK**.

## ✓ Grayed-Out Items

- Some items and menu options may be unavailable depending on camera status. Unavailable items are displayed in gray.
- In some cases, pressing **OK** when a grayed-out item is highlighted will display a message explaining why the item is unavailable.

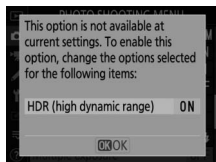
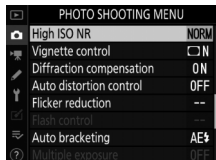

## ✓ Text Entry

A keyboard is displayed when text entry is required. Enter text as described below.

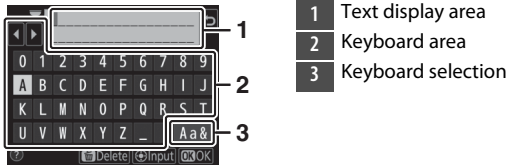





- Enter characters at the current cursor position by highlighting them with the multi selector arrow keys and then pressing the center of the multi selector.
  - To move the cursor left or right in the text display area, rotate the main command dial.
  - To cycle through the upper- and lower-case and symbol keyboards, highlight the keyboard selection icon and press the center of the multi selector. The keyboard selection icon may not be available in some cases.
  - If a character is entered when the text display area is full, the rightmost character will be deleted.
  - To delete the character under the cursor, press the (FORMAT) button.
  - To complete entry, press **OK**.
  - To exit without completing text entry, press **MENU**.
-

---

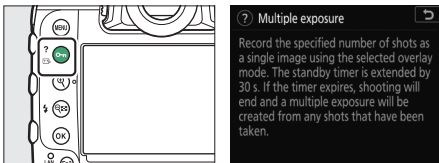
## The ? (Help) Icon

- Where available, a description of the currently-selected item can be viewed by pressing the  button.



- Press  or  to scroll.
- Press  again to return to the menus.

## Touch Controls

You can also navigate the menus using touch controls ( 25).

---

## The *i* Button (the *i* Menu)

For quick access to frequently-used settings, press the *i* button or tap the *i* icon in the live-view display to view the *i* menu.

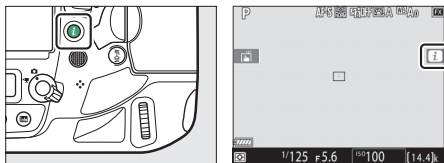

- Highlight items using the multi selector and press the center of the multi selector to view options. Highlight the desired option and press the center of the multi selector to select and return to the *i* menu.



- To cancel and return to the previous display, press the *i* button.
- Different menus are displayed during viewfinder photography, live view, and movie recording.

---

## ✓ Grayed-Out Items

Some items and menu options may be unavailable depending on camera status. Unavailable items are displayed in gray and cannot be selected.



---

## ✍ The Command Dials

- The main command dial can be used to choose the setting for the item currently highlighted in the **i** menu. Options for the selected setting, if any, can be selected by rotating the sub-command dial.
- Some items can be adjusted by rotating either dial.
- Press **OK** to save changes. You can also save changes by pressing the shutter-release button halfway or highlighting another item.



## The Still Photography *i* Menu

Pressing the *i* button during still photography displays the items listed below. Highlight the desired item using the multi-selector and press  $\odot$  to view options.

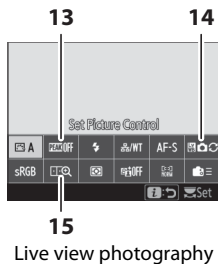
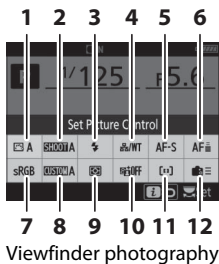



- |   |  |
|---|--|
| 1 | Set Picture Control                      |
| 2 | Photo shooting menu bank <sup>1</sup>    |
| 3 | Flash mode                               |
| 4 | Wired LAN/WT                             |
| 5 | Autofocus mode                           |
| 6 | Focus tracking with lock-on <sup>1</sup> |
| 7 | Color space                              |
| 8 | Select custom settings bank <sup>1</sup> |

- |    |   |
|----|---|
| 9  | Metering                                |
| 10 | Active D-Lighting                       |
| 11 | AF-area mode                            |
| 12 | Custom controls                         |
| 13 | Peaking highlights <sup>2</sup>         |
| 14 | Photo live view display WB <sup>2</sup> |
| 15 | Split-screen display zoom <sup>2</sup>  |

- 1 Displayed during viewfinder photography only.
- 2 Displayed during live view photography only.

---

## Customizing the *i* Menu

Choose the items displayed in the *i* menus. Use Custom Settings f1 [**Customize  menu**] and f2 [**Customize  menu (Lv)**] to choose the items displayed in viewfinder and live photography, respectively.

---

## The Movie *i* Menu

Pressing the **i** button during movie recording displays the items listed below. Highlight the desired item using the multi-selector and press **OK** to view options.

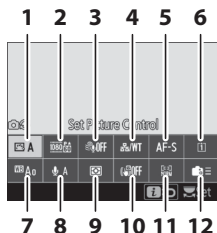

- |   |                                   |    |                        |
|---|-----------------------------------|----|------------------------|
| 1 | Set Picture Control               | 7  | White balance          |
| 2 | Frame size and rate/image quality | 8  | Microphone sensitivity |
| 3 | Wind noise reduction              | 9  | Metering               |
| 4 | Wired LAN/WT                      | 10 | Electronic VR          |
| 5 | Autofocus mode                    | 11 | AF-area mode           |
| 6 | Destination                       | 12 | Custom controls        |

---

### Customize the *i* Menu

Use Custom Setting g1 [**Customize *i* menu**] to choose the items displayed in the movie *i* menu.

---



## The Playback *i* Menu

Pressing the *i* button during playback displays a context-sensitive *i* menu of frequently-used playback options.

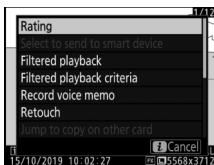
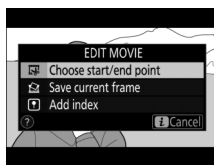

Photo playback



Movie playback



Movie playback paused

## The **Info** Button

Use the **Info** button to view shooting information or choose the indicators displayed.

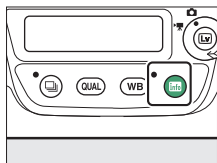

### Viewfinder Photography

During viewfinder photography, you can press the **Info** button to view an information display in the monitor. The display lists such data as shutter speed, aperture, number of exposures remaining, and AF-area mode.

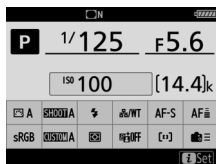

## Live View Photography

Use the **info** button to cycle through the following displays:

### ■ Live View Selector Rotated to

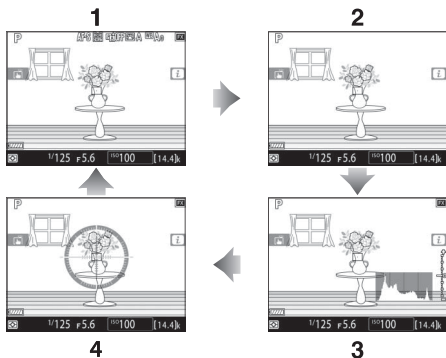

- 1 Indicators on
- 2 Simplified display
- 3 Histogram \*
- 4 Virtual horizon

\* Displayed during exposure preview only.

## Live View Selector Rotated to 90°

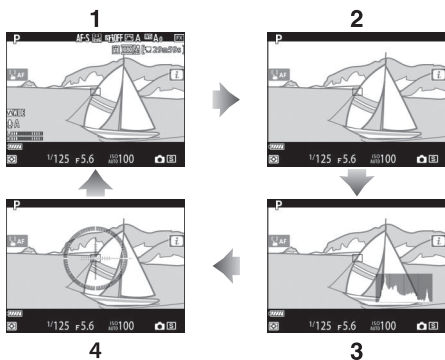

- 1 Indicators on
- 2 Simplified display
- 3 Histogram
- 4 Virtual horizon

## The Focus-Mode Selector

Choose **AF** for autofocus, **M** for manual focus.

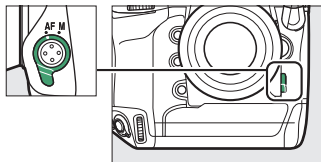

## The AF-Mode Button

Choose the AF and AF-area modes. The AF mode determines how the camera focuses in autofocus mode, the AF-area mode how the camera selects the focus point for autofocus.

### Choosing an AF Mode

Hold the AF-mode button and rotate the main command dial. The options available vary with camera settings.

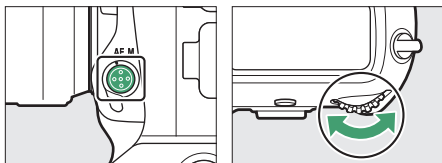

## ■ Viewfinder Photography

During viewfinder photography, the selected AF mode is displayed in the top control panel and viewfinder.



Option		Description
AF-S	[Single AF]	Use with stationary subjects. Focus locks while the shutter-release button is pressed halfway.
AF-C	[Continuous AF]	For moving subjects. The camera adjusts focus continuously in response to changes in the distance to the subject while the shutter-release button is pressed halfway.

## ■ Live View Photography and Filming

During live view photography and filming, the selected AF mode is displayed in the monitor.

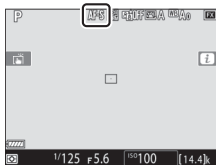

Option		Description
<b>AF-S</b>	<b>[Single AF]</b>	Use with stationary subjects. Focus locks while the shutter-release button is pressed halfway.
<b>AF-F</b>	<b>[Full-time AF]</b>	For moving subjects. The camera adjusts focus continuously in response to changes in the distance to the subject until the shutter-release button is pressed halfway. Focus locks while the shutter-release button is pressed halfway.



## **Choosing an AF-Area Mode**

Hold the AF-mode button and rotate the sub-command dial.  
The options available vary with the AF mode.

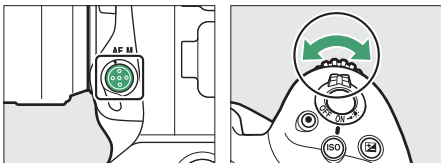

## ■ Viewfinder Photography

The selected AF-area mode is displayed in the top control panel and viewfinder during viewfinder photography.

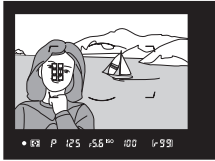

Option	Description
[Single-point AF]	The camera focuses on a point selected by the user. <ul style="list-style-type: none"><li>• Use with stationary subjects.</li></ul>
[Dynamic-area AF (9 points)]/ [Dynamic-area AF (25 points)]/ [Dynamic-area AF (49 points)]/ [Dynamic-area AF (105 points)]	The camera focuses on a point selected by the user; if the subject briefly leaves the selected point, the camera will focus based on information from surrounding focus points. Dynamic-area AF is available when <b>AF-C</b> is selected for autofocus mode. <ul style="list-style-type: none"><li>• Choose for subjects that move unpredictably. The greater the number of focus points, the wider the area used for focus.</li></ul>
[3D-tracking]	The user selects the focus point; while the shutter-release button is pressed halfway, the camera will track subjects that leave the selected focus point and select new focus points as required. 3D-tracking is available when <b>AF-C</b> is selected for autofocus mode. <ul style="list-style-type: none"><li>• Use for subjects that are moving erratically from side to side.</li></ul>

Option	Description
<p>[Group-area AF]/ [Group-area AF (C1)]/[Group-area AF (C2)]</p>	<p>The camera focuses using a group of focus points selected by the user.</p> <ul style="list-style-type: none"> <li>• Choose for snapshots, subjects that are in motion, and other subjects that are difficult to photograph using [Single-point AF].</li> <li>• Use [Group-area AF (C1)] and [Group-area AF (C2)] to create custom groups in which the number of focus points in each dimension can be chosen using the multi selector. This can be used, for example, if the size and shape of the area used for focus can be determined in advance with a fair degree of accuracy.</li> </ul>
<p>[Auto-area AF]</p>	<p>The camera automatically detects the subject and selects the focus point. If a face is detected, the camera will give priority to the portrait subject.</p> 

---

## ✔ Custom Focus Groups: [Group-Area AF (C1)]/[Group-Area AF (C2)]

- When [Group-area AF (C1)] or [Group-area AF (C2)] is highlighted, you can adjust the width of the custom focus group by holding the AF-mode button and pressing or . Press or to choose the height. The height and width are shown in the top control panel.

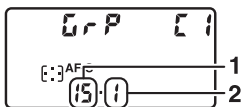

- 1 Width (number of focus points)
- 2 Height (number of focus points)

- If you keep your eye to the viewfinder while choosing the number of focus points, you can preview the shape of the selected custom focus group.

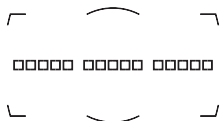



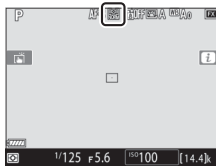

- The number of focus points can also be selected using Custom Setting a10 [Custom groupings (C1/C2)].
-

## ■ Live View Photography/Movie Recording

The selected AF-area mode is displayed in the monitor during live view photography and filming.



Option	Description
 <b>[Face-priority AF]</b>	The camera automatically detects and focuses on portrait subjects; the selected subject is indicated by a yellow border. If multiple faces (up to a maximum of 16) are detected, you can choose a subject using the multi selector. <ul style="list-style-type: none"><li>• Use for portraits.</li></ul>
 <b>[Wide-area AF]</b>	As for <b>[Normal-area AF]</b> except that the camera focuses on a wider area.
 <b>[Normal-area AF]</b>	The camera focuses on a point selected by the user.
 <b>[Subject-tracking AF]</b>	Position the focus point over your subject and press the center of the multi selector; the focus point will track the selected subject as it moves through the frame. To end tracking, press the center of the multi selector again. <ul style="list-style-type: none"><li>• Use to track focus on a chosen subject.</li></ul>

## Manual Focus-Point Selection

When an option other than [Auto-area AF], [Face-priority AF], or [Subject-tracking AF] is selected for AF-area mode, you can select the focus point manually. Press the multi selector up, down, left, or right (⬆️⬇️⬅️➡️) or diagonally to select the focus point.

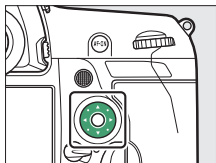

## Locking Focus-Point Selection

Focus-point selection can be locked by rotating the focus selector lock to the “L” position. Focus-point selection can be re-enabled by rotating the lock to ●.



## The AF-ON Button

The **AF-ON** button can be used for focus in autofocus mode.

- You can choose the role assigned to the **AF-ON** button. Use Custom Settings f3 [**Custom controls**] and g2 [**Custom controls**] in the Custom Settings menu to choose the roles played by the button during photography and movie recording, respectively.

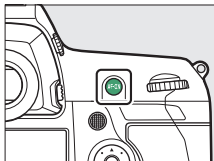

---

### The AF-ON Button for Vertical Shooting

The **AF-ON** button performs the same function, but can only be used when the vertical shooting shutter-release button lock is unlocked.

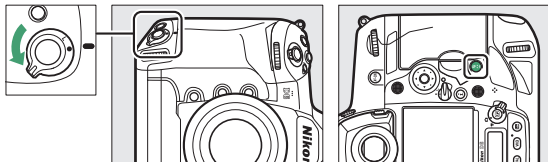

## The MODE Button

Choose an exposure mode.

### Choosing an Exposure Mode

Hold the **MODE** button and rotate the main command dial.

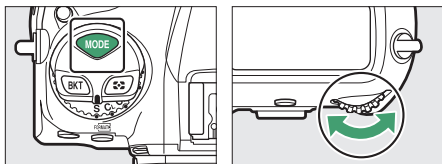

Mode		Description
<b>P</b>	<b>Programmed auto</b>	The camera sets shutter speed and aperture for optimal exposure.
<b>S</b>	<b>Shutter-priority auto</b>	You choose the shutter speed; the camera selects the aperture for best results.
<b>A</b>	<b>Aperture-priority auto</b>	You choose the aperture; the camera selects the shutter speed for best results.
<b>M</b>	<b>Manual</b>	You control both shutter speed and aperture. Set shutter speed to "bulb" or "time" for long time-exposures.



## The Release Mode Dial and Button



Rotate the release mode dial to choose the operation performed when the shutter is released.

### Choosing a Release Mode

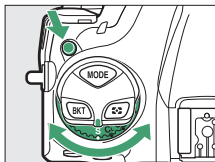
Press the release mode dial lock release on top of the camera and rotate the release mode dial.



Mode		Description
S	<b>Single frame</b>	The camera takes one photograph each time the shutter-release button is pressed.
CL	<b>Continuous low speed</b>	The camera takes photos at a selected rate while the shutter-release button is pressed. The frame rate can be selected from values between 1 and 10 fps.
CH	<b>Continuous high speed</b>	The camera takes photos at a selected rate while the shutter-release button is pressed. The frame rate can be selected from values between 10 and 14 fps.

Mode		Description
Q	<b>Quiet shutter release</b>	Take pictures more quietly than in single-frame mode. Burst shooting at rates of 1 to 5 fps is also supported.
	<b>Self-timer</b>	Take pictures with the self-timer.
MUP	<b>Mirror up</b>	The mirror is raised before shooting to minimize blur caused by camera shake.
	<b>Quick release-mode selection</b>	The release mode can be selected by holding the  button and rotating the main command dial.



## The Button

Use the  button to choose how the camera meters light when setting exposure.

### Choosing a Metering Option

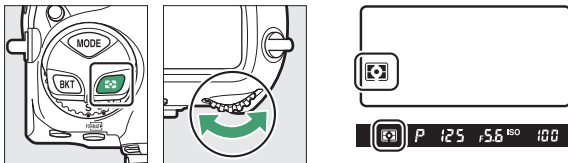
Hold the  button and rotate the main command dial.



Option	Description
 <b>[Matrix metering]</b>	Matrix metering is adapted to a wide range of subjects. It produces natural-looking results.
 <b>[Center-weighted metering]</b>	The camera assigns the greatest weight to the center of the frame. It can be used with subjects that dominate the composition, for example.

Option	Description
<input type="checkbox"/> [Spot metering]	The camera meters a circle 4 mm (0.16 in.) in diameter (approximately 1.5% of frame). Use for example to meter a specific area of the frame when your subject is backlit or features sharply contrasting areas.
<input type="checkbox"/> * [Highlight-weighted metering]	The camera assigns the greatest weight to highlights. Use this option to reduce loss of detail in highlights, for example when photographing spotlit performers on stage.

## The BKT Button

Use the **BKT** button to choose the bracketing increment and number of shots in the bracketing program. Bracketing is used to vary exposure, flash level, white balance, or Active D-Lighting (ADL) over a series of shots.

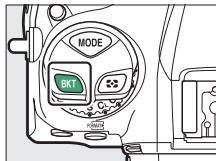

- The role performed by the **BKT** button can be chosen using Custom Setting f3 [**Custom controls**].

## The ISO (FORMAT) Button

Use the ISO (FORMAT) button to adjust the camera's sensitivity to light (ISO sensitivity). The higher the ISO sensitivity, the less light needed to make an exposure, allowing faster shutter speeds or smaller apertures. You also have the option of enabling auto ISO sensitivity control, which automatically adjusts sensitivity if optimal exposure cannot be achieved at the setting selected by the user.

### **Adjusting ISO Sensitivity**

Hold the ISO (FORMAT) button and rotate the main command dial.

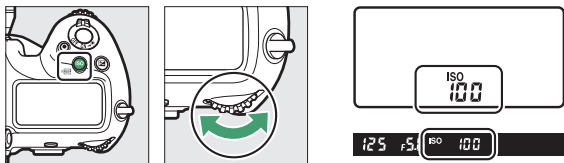

Choose from values of from ISO 100 to 102400. Settings of from about 0.3 to 1 EV below ISO 100 and 0.3 to 5 EV above ISO 102400 are also available.

---

### ✓ High ISO Sensitivities

The higher the ISO sensitivity, the less light needed to make an exposure, allowing pictures to be taken when lighting is poor and helping prevent blur when the subject is in motion. Note, however, that the higher the sensitivity, the more likely the image is to be affected by “noise” in the form of randomly-spaced bright pixels, fog, or lines.

---

## Enabling Auto ISO Sensitivity Control

Hold the **ISO** () button and rotate the sub-command dial to choose whether the camera will automatically adjust ISO sensitivity if the desired exposure cannot be achieved at the value selected by the user.

- When auto ISO sensitivity control is enabled, **ISO AUTO** indicators will appear in the top control panel and viewfinder. When these indicators are lit (not flashing), pictures will be taken at the sensitivity selected for [**ISO sensitivity**]. When sensitivity is altered from the value selected by the user, the **ISO AUTO** indicators will flash and the altered value will be shown in the displays.

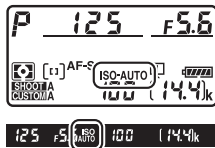
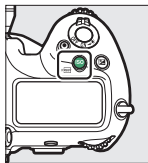

---

### **Maximum Sensitivity**

You can select an upper limit for auto ISO sensitivity control to prevent ISO sensitivity being raised too high. The maximum ISO sensitivity can be selected using the [**ISO sensitivity settings**] > [**Auto ISO sensitivity control**] > [**Maximum sensitivity**] item in the photo shooting menu.

---



## The Button

Use the  (exposure compensation) button to alter exposure from the value suggested by the camera. Exposure compensation can be used to make pictures brighter or darker.



-1 EV



No exposure  
compensation



+1 EV

### Adjusting Exposure Compensation

Hold the  button and rotate the main command dial.

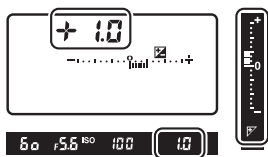
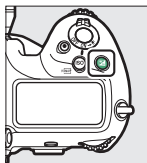

- Higher values make the subject brighter, lower values darker.
- Normal exposure can be restored by setting exposure compensation to  $\pm 0.0$ . Exposure compensation is not reset when the camera is turned off.

## The QUAL Button

The **QUAL** button is used to adjust image quality and choose the size of JPEG images.

### Adjusting Image Quality

Hold the **QUAL** button and rotate the main command dial.

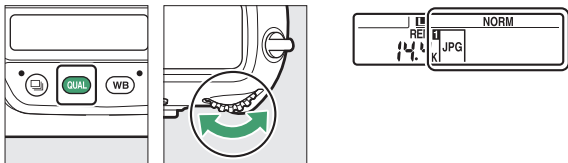

Option	Description
[NEF (RAW) + JPEG fine★]	Record two copies of each photo: an NEF (RAW) image and a JPEG copy. For the JPEG copy, you can choose from options prioritizing image quality or file size. Options with a star ("★") prioritize image quality, those without a star ("★") file size.
[NEF (RAW) + JPEG fine]	
[NEF (RAW) + JPEG normal★]	
[NEF (RAW) + JPEG normal]	
[NEF (RAW) + JPEG basic★]	
[NEF (RAW) + JPEG basic]	
[NEF (RAW)]	Record photos in NEF (RAW) format.

Option	Description
[JPEG fine★]	Record photos in JPEG format. Image quality increases as quality progress from basic through normal to fine. Options with a star ("★") prioritize image quality, those without a star ("★") file size.
[JPEG fine]	
[JPEG normal★]	
[JPEG normal]	
[JPEG basic★]	
[JPEG basic]	

### Dual-Format Recording

- If you select [RAW Slot 1 - JPEG Slot 2] for [Role played by card in Slot 2] in the photo shooting menu when taking pictures with a NEF (RAW) + JPEG option selected for image quality, the NEF (RAW) copies will be recorded to the card in Slot 1 and the JPEG copies to the card in Slot 2.
- If a JPEG option is selected for image quality and [JPEG Slot 1 - JPEG Slot 2] is selected for [Role played by card in Slot 2], the camera will record two copies of each picture, one to each memory card and each at different sizes.

## Choosing an Image Size

Hold the **QUAL** button and rotate the sub-command dial.

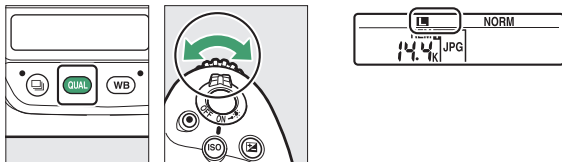

- Choose from [**Large**], [**Medium**], and [**Small**]; the selected option applies to JPEG photos. The physical dimensions of the photos in pixels varies with image area.

Image area	Image size		
	[Large]	[Medium]	[Small]
[FX (36×24)]	5568×3712	4176×2784	2784×1856
[1.2× (30×20)]	4640×3088	3472×2312	2320×1544
[DX (24×16)]	3648×2432	2736×1824	1824×1216
[5:4 (30×24)]	4640×3712	3472×2784	2320×1856
[1:1 (24×24)]	3712×3712	2784×2784	1856×1856
[16:9 (36×20)]	5568×3128	4176×2344	2784×1560

- The size of NEF (RAW) images can be selected using the [**Image size**] > [**NEF (RAW)**] item in the photo shooting menu.

## The WB Button

The **WB** button can be used to adjust white balance. White balance delivers natural colors with light sources of different hues.

### Adjusting White Balance

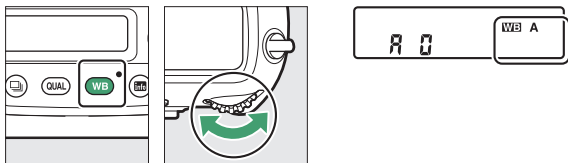

Hold the **WB** button and rotate the main command dial.

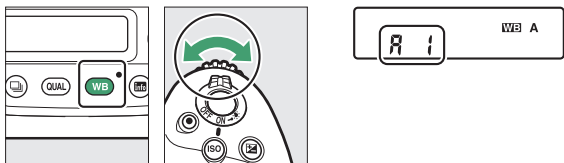

Options for the selected setting, if any, can be selected by holding the **WB** button and rotating the sub-command dial.



Option	Description
AUTO [Auto]	White balance is adjusted automatically for optimal results with most light sources.
AUTO0 [Keep white (reduce warm colors)]	Eliminate the warm color cast produced by incandescent lighting.
AUTO1 [Keep overall atmosphere]	Partially preserve the warm color cast produced by incandescent lighting.
AUTO2 [Keep warm lighting colors]	Preserve the warm color cast produced by incandescent lighting.
☀️ A [Natural light auto]	When used under natural light in place of [Auto], this option produces colors closer to those seen by the naked eye.
☀️ [Direct sunlight]	Use with subjects lit by direct sunlight.
☁️ [Cloudy]	Use in daylight under overcast skies.
🏠 [Shade]	Use in daylight with subjects in shade.
💡 [Incandescent]	Use under incandescent lighting.

Option	Description
 <b>[Fluorescent]</b> <b>[Sodium-vapor lamps]</b> <b>[Warm-white fluorescent]</b> <b>[White fluorescent]</b> <b>[Cool-white fluorescent]</b> <b>[Day white fluorescent]</b> <b>[Daylight fluorescent]</b> <b>[High temp. mercury-vapor]</b>	Use under fluorescent lighting; choose the bulb type according to the light source.
 <b>[Flash]</b>	Use for flash photography.
 <b>[Choose color temperature]</b>	Choose the color temperature directly.
<b>PRE [Preset manual]</b>	Measure white balance for the subject or light source or copy white balance from an existing photograph.

---

## ✔ Fine-Tuning White Balance

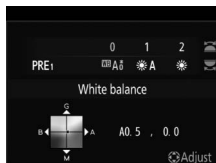
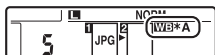

To fine-tune white balance, use the multi selector while holding the **WB** button.

- When an option other than [**Choose color temperature**] or [**Preset manual**] is selected, you can fine-tune white balance on the amber-blue axis by pressing or and on the green-magenta axis by pressing or .
- When [**Choose color temperature**] is selected, you can press or to highlight a digit. Press or to change.
- Release the **WB** button to return to shooting mode.
- At settings other than 0, an asterisk ("**\***") appears in the rear control panel.
- To view the current value, press the **WB** button while shooting information is displayed.















## The (/?) Button

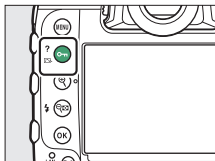



Use the  (/?) button to choose image processing (“Picture Control”) options for new photos according to the scene or your creative intent.

### **Choosing a Picture Control**

Pressing the  (/?) button displays Picture Control options. Highlight an option using  or  and press  to select.









Option		Description
 A	<b>[Auto]</b>	The camera automatically adjusts hues and tones based on the <b>[Standard]</b> Picture Control.
 SD	<b>[Standard]</b>	Standard processing for balanced results. Recommended for most situations.
 NL	<b>[Neutral]</b>	Minimal processing for natural results. Choose for photographs that will later be processed or retouched.
 VI	<b>[Vivid]</b>	Pictures are enhanced for a vivid, photoprint effect. Choose for photographs that emphasize primary colors.
 MC	<b>[Monochrome]</b>	Take monochrome photographs.

Option		Description
 PT	<b>[Portrait]</b>	Smooth complexions for natural-looking portraits.
 LS	<b>[Landscape]</b>	Shoot vibrant landscapes and cityscapes.
 FL	<b>[Flat]</b>	Details are preserved over a wide tone range, from highlights to shadows. Choose for photographs that will later be extensively processed or retouched.
 01 -  20	<b>Creative Picture Control</b>	Creative Picture Controls offer unique combinations of hue, tone, saturation, and other settings tuned for particular effects. Choose from a total of 20 options, including <b>[Dream]</b> and <b>[Morning]</b> .

## ■ ■ Modifying Picture Controls

To modify Picture Control settings, highlight a Picture Control and press .

- Press  or  to highlight settings. Press  or  to choose a value in increments of 1, or rotate the sub-command dial to choose a value in increments of 0.25.
- The options available vary with the Picture Control selected.
- Default settings can be restored by pressing the  (FORMAT) button.
- Press  to save changes.
- Picture Controls that have been modified from default settings are indicated by an asterisk ("**\***").

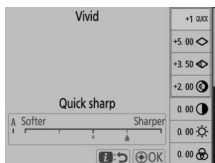

## Picture Control Settings

Option	Description
[Effect level]	Mute or heighten the effect of Creative Picture Controls.
[Quick sharp]	Quickly adjust levels for balanced [Sharpening], [Mid-range sharpening], and [Clarity]. These parameters can also be adjusted individually.
[Sharpening]	Control the sharpness of details and outlines.
[Mid-range sharpening]	Adjust the sharpness of patterns and lines in the range between [Sharpening] and [Clarity].
[Clarity]	Adjust overall sharpness and the sharpness of thicker outlines without affecting brightness or dynamic range.
[Contrast]	Adjust contrast.
[Brightness]	Raise or lower brightness without loss of detail in highlights or shadows.
[Saturation]	Control the vividness of colors.
[Hue]	Adjust hue.
[Filter effects]	Simulate the effect of color filters on monochrome pictures.
[Toning]	Choose the tint used in monochrome pictures. Pressing  when an option other than [B&W] (black-and-white) is selected displays saturation options.
[Toning] (Creative Picture Control)	Choose the shade of color used for Creative Picture Controls.

## ✓ The $\Delta$ Indicator

The  $\Delta$  indicator under the value display in the Picture Control setting menu indicates the previous value for the setting.



## ✓ [A] (Auto)

- Selecting the [A] (auto) option available for some settings lets the camera adjust the setting automatically.
- Results vary with exposure and the position of the subject in the frame.

## ✓ [Filter Effects]

Choose from the following [Filter effects]:

Option	Description
[Y] (yellow) *	These options enhance contrast and can be used to tone down the brightness of the sky in landscape photographs. Orange [O] produces more contrast than yellow [Y], red [R] more contrast than orange.
[O] (orange) *	
[R] (red) *	
[G] (green) *	Green softens skin tones. Use for portraits and the like.

- \* The term in parentheses is the name of the corresponding third-party color filter for black-and-white photography.

---

## ✔ The [Auto] Picture Control

Settings can be adjusted in the range [A-2] to [A+2].

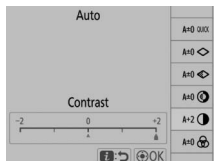

## ✔ Protecting Pictures from Deletion

During playback, the  (L/?) button can be used to protect pictures. Protecting pictures helps prevent accidental deletion.

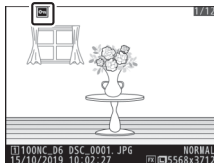

## ✔ Viewing Help

Press the  (L/?) button to view help for the current item, where available (📖 87).

---



## The (⚡) Button

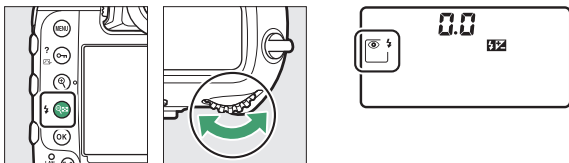

During shooting, the  button can be used to choose the flash mode and adjust flash compensation for optional flash units. Flash mode determines the effect produced by the flash, flash compensation the flash level.

### Choosing a Flash Mode

Hold the  button and rotate the main command dial.



	Option	Description
	<b>[Fill flash]</b> (front-curtain sync)	This mode is recommended for most situations.
	<b>[Red-eye reduction]</b> (red-eye reduction)	The flash fires before the photograph is taken, reducing "red-eye".
	<b>[Slow sync]</b> (slow sync)	As for "fill flash", except that slow shutter speeds are used to capture background lighting at night or under low light.

	Option	Description
	<b>[Slow sync + red-eye]</b> (red-eye reduction with slow sync)	As for “red-eye reduction”, except that slow shutter speeds are used to capture background lighting at night or under low light.
	<b>[Rear-curtain sync]</b> (rear-curtain sync)	The flash fires just before the shutter closes.
	<b>[Flash off]</b>	The flash does not fire.



## Adjusting Flash Compensation

Hold the  button and rotate the sub-command dial.

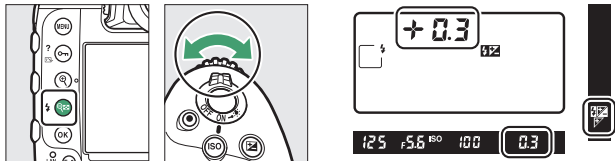

- Choose positive values for brighter lighting, negative values to ensure that the subject is not too brightly lit.
- Normal flash output can be restored by setting flash compensation to  $\pm 0.0$ . Flash compensation is not reset when the camera is turned off.

## The Pv Button

Pressing the **Pv** button during viewfinder photography stops lens aperture down to the current value, allowing depth of field to be previewed as long as the button is kept pressed.

- Optional flash units compatible with the Nikon Creative Lighting System (CLS) will emit a modeling flash. The modeling flash can be disabled by selecting [**Off**] for Custom Setting e6 [**Modeling flash**].
- You can choose the role assigned to the **Pv** button. Use Custom Settings f3 [**Custom controls**] and g2 [**Custom controls**] in the Custom Settings menu to choose the roles played by the button during photography and filming, respectively.

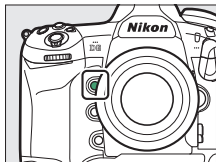

## The Fn1, Fn2, Fn3 (👉), and Fn (Vertical) Buttons

Use the **Fn1**, **Fn2**, **Fn3** (👉), or vertical **Fn** button for quick access to selected settings.

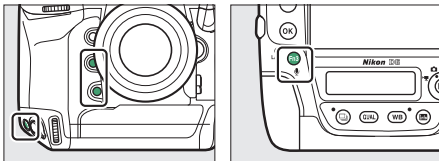

- The assigned setting can be adjusted by holding the corresponding button and rotating the command dials. In some cases, adjustments can be made using both the main and sub-command dials.
- Use Custom Settings f3 [**Custom controls**] and g2 [**Custom controls**] in the Custom Settings menu to choose the roles played by these buttons during photography and movie recording, respectively.

# Shooting Settings

## Image Recording Options (Image Area, Quality, and Size)





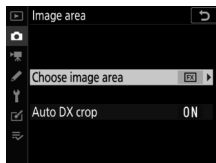

### Adjusting Image Area Settings

Image area settings can be displayed by selecting **[Image area]** in the photo shooting menu.



## ■ Choose Image Area

Choose the image area. The following options are available:

	Option	Description
	<b>[FX(36×24)]</b>	Record pictures in FX format with an angle of view equivalent to a 35 mm format camera. Use this option when taking photographs with NIKKOR lenses for 35 mm format cameras.
	<b>[1.2×(30×20)]</b>	Reduces the angle of view of the lens mounted on the camera to that of a lens with a focal length approximately 1.2 times longer.
	<b>[DX(24×16)]</b>	Pictures are recorded in DX format. To calculate the approximate focal length of the lens in 35 mm format, multiply by 1.5.
	<b>[5:4(30×24)]</b>	Pictures are recorded with an aspect ratio of 5:4.
	<b>[1:1(24×24)]</b>	Pictures are recorded with an aspect ratio of 1:1.
	<b>[16:9(36×20)]</b>	Pictures are recorded with an aspect ratio of 16:9.

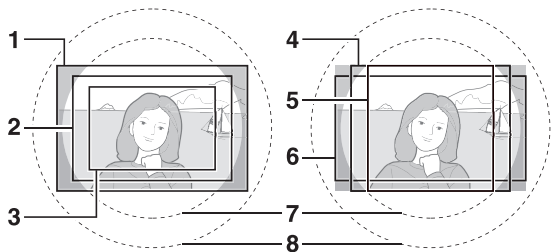

**1** FX (36×24)

**2** 1.2× (30×20)

**3** DX (24×16)

**4** 5:4 (30×24)

**5** 1:1 (24×24)

**6** 16:9 (36×20)

**7** DX format image circle

**8** 35 mm format image circle

## ■ Auto DX Crop

Choose whether the camera automatically selects the **[DX (24×16)]** (DX format) image area when a DX lens is attached.

Option	Description
<b>[On]</b>	The camera automatically selects the <b>[DX (24×16)]</b> (DX format) image area when a DX lens is attached.
<b>[Off]</b>	Automatic image-area selection disabled.

## ✓ Cropping

DX lenses are designed for use with DX format cameras and have a smaller angle of view than lenses for 35 mm format cameras. If **[Off]** is selected for **[Auto DX crop]** and an option other than **[DX (24 × 16)]** (DX format) is selected for **[Choose image area]** when a DX lens is attached, the edges of the image may be eclipsed. This is referred to as “cropping”. Cropping may not be apparent in the viewfinder, but when the images are played back you may notice a drop in resolution or that the edges of the picture are blacked out.

## The Viewfinder Display

The viewfinder displays for image area options other than [FX (36×24)] are shown below. The area outside the current crop is shown in gray.

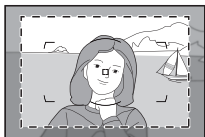

1.2× (30×20)



DX (24×16)



5:4 (30×24)



1:1 (24×24)



16:9 (36×20)



## Choosing the Image Area via Buttons and Command Dials

If [**Choose image area**] has been assigned to a button using Custom Setting f3 [**Custom controls**], the image area can be selected by pressing the button and rotating a command dial.

- The selected crop is displayed in the viewfinder.
- The option currently selected for image area can be displayed in the top control panel and viewfinder by pressing the button to which [**Choose image area**] is assigned.
- Camera controls assigned [**Choose image area**] cannot be used for image area selection when a DX lens is attached and [**On**] is selected for [**Auto DX crop**].

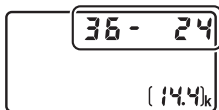

Image area	Display
[FX (36×24)]	36 - 24
[1.2× (30×20)]	30 - 20
[DX (24×16)]	24 - 16
[5:4 (30×24)]	30 - 24
[1:1 (24×24)]	24 - 24
[16:9 (36×20)]	36 - 20

## Image Size

Image size varies with the option selected for [**Image area**].

---

## Adjusting Image Quality

Choose the image quality option used when photographs are recorded.

Option	Description
[NEF (RAW) + JPEG fine★]	<p>Record two copies of each photo: an NEF (RAW) image and a JPEG copy.</p> <ul style="list-style-type: none"><li>• For the JPEG copy, you can choose from options prioritizing image quality or file size. Choose options with a star ("★") to maximize image quality. Choose options without a star ("★") to ensure that the JPEG copies all have more or less the same file size.</li><li>• Only the JPEG copy is displayed during playback. If only one memory card was inserted in the camera when the photos were recorded, the NEF (RAW) copies can only be viewed using a computer.</li><li>• If the photo was recorded with only one memory card inserted or with [Overflow] or [Backup] selected for [Role played by card in Slot 2] and two memory cards inserted, deleting the JPEG copy on the camera will also delete the NEF (RAW) image.</li></ul>
[NEF (RAW) + JPEG fine]	
[NEF (RAW) + JPEG normal★]	
[NEF (RAW) + JPEG normal]	
[NEF (RAW) + JPEG basic★]	
[NEF (RAW) + JPEG basic]	

Option	Description
[NEF (RAW)]	Record photos in NEF (RAW) format.
[JPEG fine★]	Record photos in JPEG format. "Fine" produces higher quality pictures than "normal" and "normal" higher quality pictures than "basic". • Choose options with a star ("★") to maximize image quality. Choose options without a star ("★") to ensure that the JPEG copies all have more or less the same file size.
[JPEG fine]	
[JPEG normal★]	
[JPEG normal]	
[JPEG basic★]	
[JPEG basic]	

### NEF (RAW)

- NEF (RAW) image files contain the raw data output from the image sensor. They have the extension "\*.nef".
- Using Nikon's ViewNX-i or Capture NX-D software, you can adjust and re-adjust settings such as exposure compensation and white balance. Such adjustments can be performed as often as you please without degrading image quality, making this the ideal format for photos that will be processed in multiple different ways. ViewNX-i and Capture NX-D are available free-of-charge from the Nikon Download Center.
- The process of converting NEF (RAW) images to other formats such as JPEG is referred to as "NEF (RAW) processing". You can save NEF (RAW) images in other formats using the ViewNX-i and Capture NX-D computer applications or the **[NEF (RAW) processing]** option in the camera retouch menu.

## ■ Choosing an Image Quality Option

To choose an image quality option during viewfinder photography, hold the **QUAL** button and rotate the main command dial. The selected option is displayed in the rear control panel.

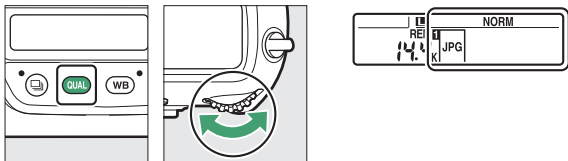

---

### ✔ The Photo Shooting Menu [Image Quality] Option

Image quality can also be adjusted using the [Image quality] item in the photo shooting menu. Use the [Image quality] item in the photo shooting menu to adjust image quality during live view.

#### ✔ “NEF (RAW) + JPEG”

- The camera displays only the JPEG copies of photos recorded at image quality settings of “NEF (RAW) + JPEG”. If only one memory card was inserted in the camera when the photos were recorded, the NEF (RAW) copies can only be viewed using a computer.
  - In the case of photos recorded with only one memory card inserted, deleting the JPEG copies on the camera also deletes the NEF (RAW) images.
  - If [RAW Slot 1 - JPEG Slot 2] is selected for [Role played by card in Slot 2], the NEF (RAW) copies will be recorded to the card in Slot 1 and the JPEG copies to the card in Slot 2 (☐ 308).
-

## Choosing an Image Size

Choose a size for new JPEG pictures. The size for JPEG pictures can be selected from [**Large**], [**Medium**], and [**Small**]. The number of pixels in the image varies with the option selected for image area (☞ 136).

<b>Image area</b>	<b>Image size</b>
<b>[FX (36×24)]</b>	Large (5568 × 3712 pixels)
	Medium (4176 × 2784 pixels)
	Small (2784 × 1856 pixels)
<b>[1.2× (30×20)]</b>	Large (4640 × 3088 pixels)
	Medium (3472 × 2312 pixels)
	Small (2320 × 1544 pixels)
<b>[DX (24×16)]</b>	Large (3648 × 2432 pixels)
	Medium (2736 × 1824 pixels)
	Small (1824 × 1216 pixels)

Image area	Image size
[5:4 (30×24)]	Large (4640 × 3712 pixels)
	Medium (3472 × 2784 pixels)
	Small (2320 × 1856 pixels)
[1:1 (24×24)]	Large (3712 × 3712 pixels)
	Medium (2784 × 2784 pixels)
	Small (1856 × 1856 pixels)
[16:9 (36×20)]	Large (5568 × 3128 pixels)
	Medium (4176 × 2344 pixels)
	Small (2784 × 1560 pixels)

### **Print Size**

Print size in inches equals image size in pixels divided by printer resolution in dots per inch (dpi; 1 inch = 2.54 cm).

## ■ Choosing an Image Size

To choose a size for JPEG images during viewfinder photography, hold the **QUAL** button and rotate the sub-command dial. The selected option is displayed in the rear control panel.

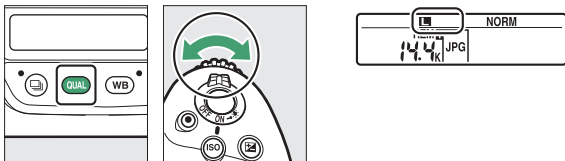

- To choose a size for NEF (RAW) images, use the **[Image size] > [NEF (RAW)]** option in the photo shooting menu.

---

### The Photo Shooting Menu [Image Size] Option

- Image size can also be adjusted using the **[Image size] > [JPEG]** and **[NEF (RAW)]** options in the photo shooting menu.
  - Selecting a size of **[Medium]** or **[Small]** for NEF (RAW) pictures fixes the **[NEF (RAW) recording] > [NEF (RAW) compression]** and **[NEF (RAW) bit depth]** options in the photo shooting menu at **[Lossless compressed]** and **[12-bit]**, respectively.
-

# Choosing How the Camera Focuses (Focus)

## Choosing a Focus Mode

Rotate the focus-mode selector to **AF** to select autofocus or to **M** to select manual focus.

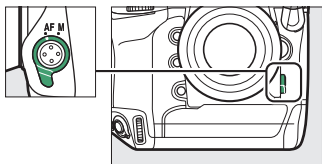

During viewfinder photography, the camera focuses using 105 focus points.

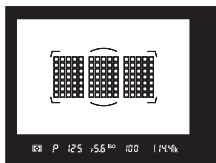



## Autofocus Mode

Choose how the camera focuses in autofocus mode.

### ■ Viewfinder Photography

	Option	Description
AF-S	[Single AF]	<p>Use with stationary subjects. Focus locks while the shutter-release button is pressed halfway. The shutter cannot be released unless the camera is in focus.</p> <ul style="list-style-type: none"><li>• At default settings, the shutter can be released only when the camera is in focus (focus priority).</li></ul>
AF-C	[Continuous AF]	<p>Use for shots of athletes and other moving subjects. If the subject moves while the shutter-release button is pressed halfway, the camera will engage predictive focus tracking to predict final distance to subject and adjust focus as necessary.</p> <ul style="list-style-type: none"><li>• Focus does not lock when the in-focus indicator (●) is displayed; instead, the camera adjusts focus continuously until the shutter is released.</li><li>• At default settings, the shutter can be released whether or not subject is in focus (release priority).</li></ul>

---

### **Predictive Focus Tracking**

In autofocus mode **AF-C**, the camera will initiate predictive focus tracking if the subject moves toward or away from the camera while the shutter-release button is pressed halfway or the **AF-ON** button is pressed. This allows the camera to track focus while attempting to predict where the subject will be when the shutter is released.

---

## ■ Live View Photography and Filming

Option		Description
<b>AF-S</b>	<b>[Single AF]</b>	Use with stationary subjects. Focus locks while the shutter-release button is pressed halfway.
<b>AF-F</b>	<b>[Full-time AF]</b>	Use with moving subjects. The camera adjusts focus continuously in response to subject motion until the shutter-release button is pressed halfway. Focus locks when the shutter-release button is pressed halfway.

## ■ Choosing an Autofocus Mode

To choose the autofocus mode, hold the AF-mode button and rotate the main command dial.

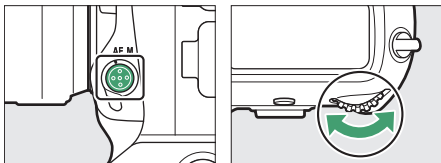

- During viewfinder photography, the selected option is displayed in the viewfinder and top control panel.



- During live view or while movies are being filmed, the selected option is displayed in the monitor.



## AF-Area Mode

Choose how the camera selects the focus point for autofocus.

### ■ Viewfinder Photography

Option	Description
[Single-point AF]	<p>The user selects the focus point (☐ 164). The camera will focus on the subject in the selected focus point only.</p> <ul style="list-style-type: none"><li>• Use with stationary subjects.</li></ul>
[Dynamic-area AF (9 points)]/ [Dynamic-area AF (25 points)]/ [Dynamic-area AF (49 points)]/ [Dynamic-area AF (105 points)]	<p>The user selects the focus point, but if the subject briefly leaves the selected point, the camera will focus based on information from surrounding focus points. Dynamic-area AF is available when <b>AF-C</b> is selected for autofocus mode.</p> <ul style="list-style-type: none"><li>• Choose for subjects that move unpredictably. The greater the number of focus points, the wider the area used for focus.</li><li>• <b>[Dynamic-area AF (9 points)]/[Dynamic-area AF (25 points)]</b>: Choose when there is time to compose the photograph or when photographing subjects that are moving predictably (e.g., runners or race cars on a track).</li><li>• <b>[Dynamic-area AF (49 points)]</b>: Choose when photographing subjects that are moving unpredictably (e.g., players at a football game).</li><li>• <b>[Dynamic-area AF (105 points)]</b>: Choose when photographing subjects that are moving quickly and cannot be easily framed in the selected focus point (e.g., birds).</li></ul>

Option	Description
[3D-tracking]	<p>The camera tracks the subject using all 105 focus points. If you keep the shutter-release button pressed halfway after focusing on the subject in the selected focus point, the camera will track the subject as it moves through the frame and select new focus points as required. 3D-tracking is available when <b>AF-C</b> is selected for autofocus mode.</p> <ul style="list-style-type: none"><li>• Use to quickly compose pictures with subjects that are moving erratically from side to side (e.g., tennis players).</li><li>• If the subject leaves viewfinder, remove your finger from the shutter-release button and recompose the photograph with the subject in the selected focus point.</li></ul>

Option	Description
<p>[<b>Group-area AF</b>]/[<b>Group-area AF (C1)</b>]/[<b>Group-area AF (C2)</b>]</p>	<p>The camera focuses using a group of focus points selected by the user. Focus is distributed over a wider area, reducing the risk of the camera focusing on the background.</p> <ul style="list-style-type: none"> <li>• Choose for snapshots, subjects that are in motion, and other subjects that are difficult to photograph using [<b>Single-point AF</b>].</li> <li>• Use [<b>Group-area AF (C1)</b>] and [<b>Group-area AF (C2)</b>] to create custom groups in which the number of focus points in each dimension can be chosen using the multi selector (☐ 167). This can be used, for example, if the size and shape of the area used for focus can be determined in advance with a fair degree of accuracy.</li> </ul>



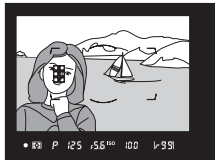



Option	Description
<p data-bbox="104 317 280 346"><b>[Auto-area AF]</b></p>	<p data-bbox="313 103 617 295">The camera automatically detects the subject and selects the focus point. If a face is detected, the camera will give priority to the portrait subject.</p> <ul data-bbox="313 299 912 564" style="list-style-type: none"> <li data-bbox="313 299 912 430">• Use on occasions when you don't have time to select the focus point yourself, for portraits, or for snapshots and other spur-of-the-moment photos.</li> <li data-bbox="313 435 912 564">• When <b>AF-S</b> is selected for autofocus mode, the active focus points are briefly highlighted after the camera focuses. When <b>AF-C</b> is selected, the camera displays the active focus points.</li> </ul>







## ✓ AF-Area Mode

AF-area mode is shown in the viewfinder and top control panel.

AF-area mode	Top control panel	Viewfinder	Viewfinder focus-point display (during selection)
[Single-point AF]	S	S	
[Dynamic-area AF (9 points)]*	d 9	d 9	
[Dynamic-area AF (25 points)]*	d 25	d 25	
[Dynamic-area AF (49 points)]*	d 49	d 49	
[Dynamic-area AF (105 points)]*	d 105	d 105	
[3D-tracking]	3d	3d	

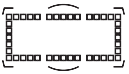
AF-area mode	Top control panel	Viewfinder	Viewfinder focus-point display (during selection)
[Group-area AF]	<i>GrP</i>	<i>GrP</i>	
[Group-area AF (C1)]	<i>GrP C1</i>	<i>C1</i>	
[Group-area AF (C2)]	<i>GrP C2</i>	<i>C2</i>	
[Auto-area AF]	<i>Auto</i>	<i>Auto</i>	

\* Only active focus point is displayed in the viewfinder. Remaining focus points provide information to assist focus operation.

---

### **3D-Tracking**

When [**3D-tracking**] is selected for AF-area mode, the camera stores the colors in the area surrounding the focus point at the moment the shutter-release button is pressed halfway. Consequently 3D-tracking may not produce the desired results with subjects that are similar in color to the background or that occupy a very small area of the frame.

### **Quick Focus-Point Selection**

Choosing [**27 points**] or [**15 points**] for Custom Setting a4 [**Focus points used**] reduces the number of focus points available via the multi selector, speeding focus-point selection.

### **Auto-Area AF Starting Point**





Selecting [**Enable**] for Custom Setting a12 [**Auto-area AF starting point**] lets you choose the starting focus point when **AF-C** is selected for AF mode. After you focus on the subject in the selected point, the camera will resume normal auto-area AF. This feature is recommended when your subject's position in the frame can be predicted with some degree of confidence.

### **AF-S/AF-I Teleconverters**

If [**3D-tracking**] or [**Auto-area AF**] is selected for AF-area mode when an AF-S/AF-I teleconverter is used, [**Single-point AF**] will automatically be selected at combined apertures slower than f/5.6.

---

## ■ Live View Photography and Filming

Option	Description
 [Face-priority AF]	<p>The camera automatically detects and focuses on portrait subjects; the selected subject is indicated by a yellow border. If multiple faces (up to a maximum of 16) are detected, you can choose a subject using the multi selector.</p> <ul style="list-style-type: none"><li>• Use for portraits.</li><li>• If the camera can no longer detect the subject, for example because they have looked away, it will cease to display the yellow border.</li></ul>
 [Wide-area AF]	<p>As for [Normal-area AF] except that the camera focuses on a wider area.</p>
 [Normal-area AF]	<p>The camera focuses on a point selected by the user.</p> <ul style="list-style-type: none"><li>• Use of a tripod is recommended.</li></ul>
 [Subject-tracking AF]	<p>Position the focus point over your subject and press the center of the multi selector; the focus point will track the selected subject as it moves through the frame. To end tracking, press the center of the multi selector again.</p> <ul style="list-style-type: none"><li>• Use to track focus on a chosen subject.</li></ul>

---

### ✔ Subject-Tracking AF

The camera may be unable to track subjects that:

- are similar in color to the background,
- change visibly in size, color, or brightness,
- are too large or too small,
- are too bright or too dark,
- move quickly, or
- are obscured by other objects or leave the frame.

## ✔ Using Autofocus in Live View

- The camera may take longer to focus in live view than during viewfinder photography. The camera may be unable to focus if:
    - The subject contains lines parallel to the long edge of the frame
    - The subject lacks contrast
    - The subject in the focus point contains areas of sharply contrasting brightness
    - The focus point includes night-time spot lighting or a neon sign or other light source that changes in brightness
    - Flicker or banding appears under fluorescent, mercury-vapor, sodium-vapor, or similar lighting
    - A cross (star) filter or other special filter is used
    - The subject appears smaller than the focus point
    - The subject is dominated by regular geometric patterns (e.g., blinds or a row of windows in a skyscraper)
    - The subject is moving
  - The monitor may brighten or darken while the camera focuses.
  - The focus point may sometimes be displayed in green when the camera is unable to focus.
  - Use an AF-S or AF-P lens, as the desired results may not be achieved with other lenses or teleconverters.
- 

## ✔ : The Center Focus Point

In all AF-area modes except [**Subject-tracking AF**], a dot appears in the focus point when it is in the center of the frame.

---

## ■ Choosing an AF-Area Mode

To choose the AF-area mode, hold the AF-mode button and rotate the sub-command dial.

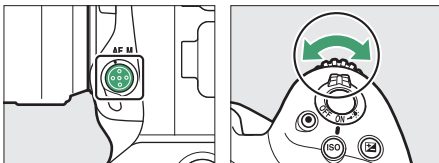

- During viewfinder photography, the selected option is displayed in the viewfinder and top control panel.



- During live view or while movies are being filmed, the selected option is displayed in the monitor.

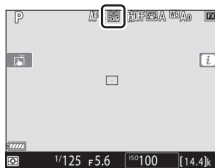

## Focus Point Selection

Except when [**Auto-area AF**] or [**Subject tracking AF**] is selected for AF-area mode, the focus point can be selected manually, allowing photographs to be composed with the subject positioned almost anywhere in the frame.

### 1 Undo the focus selector lock.

Rotate the focus selector lock to ●.

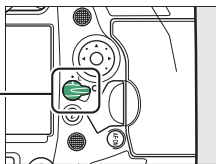

### 2 Use the multi selector to select the focus point while the standby timer is on.

- During viewfinder photography, you can choose from 105 focus points in the AF-area brackets.

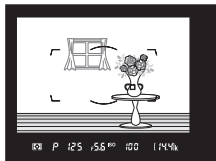





---

### ✔ The Sub-Selector

- The sub-selector can be used for focus-point selection in place of the multi selector.
- Exposure and focus lock while the center of the sub-selector is pressed.
- Be careful not to put your fingers in your eye while using the sub-selector.

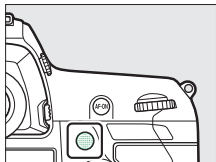

### ✔ Portrait Orientation

You may find it convenient to use the vertical multi selector when taking photographs in portrait orientation. See Custom Setting f3 [**Custom controls**] > [**Multi selector for vertical shooting**].

### ✔ Using the Sub-Selector and Vertical Multi Selector

You can press the centers of the sub-selector and vertical multi selector or tilt them as shown. The controls may not function as expected when pressed from the side.



## **Custom Focus Groups**

You can choose the dimensions of the focus groups used when [Group-area AF (C1)] and [Group-area AF (C2)] are selected for AF-area mode. Custom focus groups can be used if the size and shape of the area used for focus can be determined in advance with a fair degree of accuracy.

- 
- 1 Choose [Group-area AF (C1)] or [Group-area AF (C2)] for AF-area mode.**

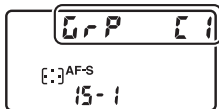

- 
- 2 Choose the dimensions of the custom focus group.**

- Hold the AF-mode button and use the multi selector to choose the dimensions of the selected custom group.

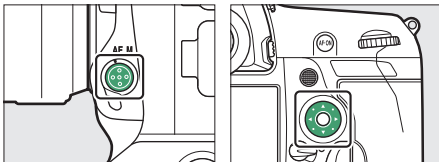

- Press or to choose the height, or to choose the width. The shape of the current AF-area group is indicated by a number in the top control panel. The shapes of the different AF-area groups are shown below.

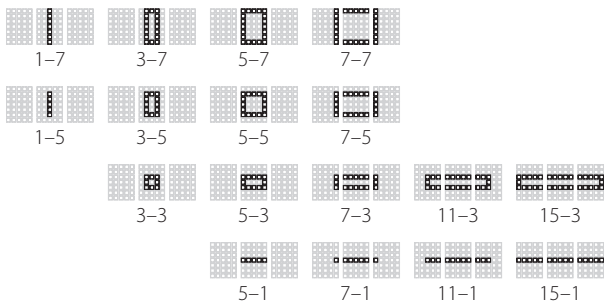
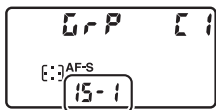

- The changes are saved when you release the AF-mode button.

---

## **Choosing Custom Focus Groups**

The dimensions of the custom focus groups for [Group-area AF (C1)] and [Group-area AF (C2)] can also be selected using Custom Setting a10 [Custom groupings (C1/C2)]. Select the desired custom group AF-area mode and size the group using the multi selector. Press  to save changes.

---

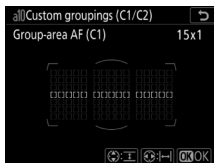

## **Focus Lock**

Use focus lock with subjects that will not be in the selected focus point in the final composition or to focus in cases in which the camera is unable to focus using autofocus (📖 173). Before using focus lock, choose an option other than **[Auto-area AF]** for AF-area mode.

---

### **1 Position the subject in the selected focus point and press the shutter-release button halfway.**

The in-focus indicator (●) will be displayed when the camera focuses.

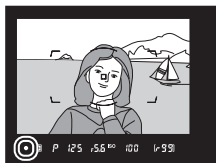

## 2 Lock focus.

### **AF-C selected for autofocus mode:**

Keeping the shutter-release button pressed halfway (①), press the center of the sub-selector (②) to lock focus. Focus and exposure will remain locked while the center of the sub-selector is pressed, even if you remove your finger from the shutter-release button.

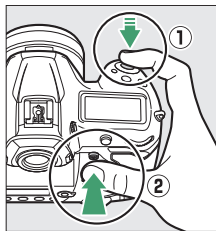

An **AE-L** icon will be displayed in the viewfinder while the center of the sub-selector is pressed.



### **AF-S selected for autofocus mode:**

Focus locks while the shutter-release button is pressed halfway. You can also lock focus by pressing the center of the sub-selector.

---

### 3 Without releasing focus lock, recompose the photograph and press the shutter-release button the rest of the way down to shoot.

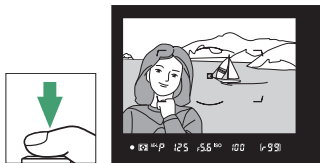

Do not change the distance between the camera and the subject. If the distance to the subject changes, release the lock and focus again at the new distance.

---

#### ✓ Taking Multiple Shots at the Same Focus Distance

- If you locked focus by pressing the shutter-release button halfway, focus will remain locked if you keep the shutter-release button pressed halfway between shots.
- If you locked focus by pressing the center of the sub-selector, focus will remain locked between shots if you keep the center of the sub-selector pressed.



## Locking Focus with the AF-ON Button

- The **AF-ON** button can be used for focus in place of the shutter-release button.
- If [**AF-ON only**] is selected for Custom Setting a6 [**AF activation**] during viewfinder photography, focus can be initiated only by pressing the **AF-ON** button; the camera will not focus when the shutter-release button is pressed halfway. Focus will remain locked after the **AF-ON** button is released. To end focus lock, press the **AF-ON** button again.

## Getting Good Results with Autofocus

The camera may be unable to focus under the conditions listed below, in which case the shutter release may be disabled or pictures may be out of focus, the latter a result of the camera either displaying the in-focus indicator (●)—or, in live view, displaying the focus point in green—when the subject is not in focus. Focus manually or use focus lock to focus on another subject at the same distance.

- There is little contrast between the subject and the background, as may be the case if the subject is photographed against a featureless wall or the background is the same color as the subject.
  - The focus point contains objects at different distances from the camera, as may be the case if the subject is inside a cage.
  - The subject is dominated by regular geometric patterns such as the rows of windows in a skyscraper.
  - The focus point contains areas of sharply contrasting brightness, as may be the case if the subject is half in the shade.
  - Background objects appear larger than the main subject, as may be the case if a building is in the frame behind the subject.
  - The subject contains many fine details, as may be the case when the subject is a field of flowers.
-

## Manual Focus

The procedure for selecting manual focus varies with the lens. Follow the steps below.

- **AF lenses:** Rotate the camera focus-mode selector to **M**. If the lens is equipped with a focus-mode switch, set it to **M** as well.

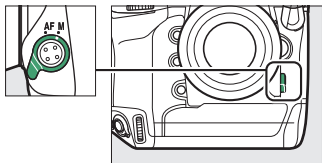

- If you are using an AF-S lens, or an AF-P lens with a focus-mode switch, set the focus-mode switch to **M**. In this case, there is no need to choose manual focus on the camera.

- **Manual focus lenses:** Manual focus is available at all times.

To focus manually, rotate the lens focus ring until the image in the viewfinder is in focus.

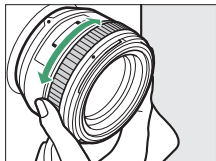

---

**✓ Using Manual Focus with AF Lenses (AF-S and AF-P Lenses Excluded)**

Be sure to rotate the camera focus-mode selector to **M** when using manual focus with AF lenses (AF-S and AF-P lenses excepted). Attempting to focus manually with the focus-mode selector set to **AF** could damage the camera or lens.

---

## ■ The Electronic Rangefinder

When focusing manually, you can use the focus indicator (●) in the viewfinder to check whether the subject in the selected focus point is in focus.

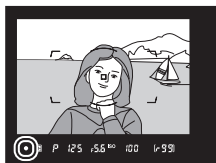

- In-focus indicator (●) is displayed when the subject is in focus.

Focus indicator	Status
● (steady)	The subject is in focus.
▶ (steady)	The focus point is in front of the subject.
◀ (steady)	The focus point is behind the subject.
▶ ◀ (flashes)	The camera is unable to focus.

- Note that with the subjects listed in “Getting Good Results with Autofocus” (□ 173), the in-focus indicator (●) may sometimes be displayed when the subject is not in focus. Confirm focus in the viewfinder before shooting.
- A tripod is recommended if you experience trouble focusing.

---

## AF-P Lenses

When an AF-P lens is used in manual focus mode, the in-focus indicator will flash in the viewfinder (or in live view, the focus point will flash in the monitor) to warn that continuing to rotate the focus ring in the current direction will not bring the subject into focus.

## The Focal Plane Mark and Flange-Back Distance

Focus distance is measured from the focal plane mark (⊖) on the camera body, which shows the position of the focal plane inside the camera (①). Use this mark when measuring the distance to your subject for manual focus or macro photography. The distance between the focal plane and the lens mounting flange is known as the “flange-back distance” (②). On this camera, the flange-back distance is 46.5 mm (1.83 in.).

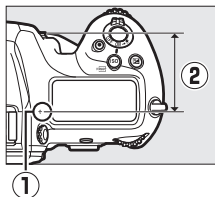

## Focus Peaking

- If an option other than **[Off]** is selected for Custom Setting d10 **[Peaking highlights]** > **[Peaking level]**, objects that are in focus will be indicated by colored outlines that appear when focus is adjusted manually during live view.
- Note that peaking highlights may not be displayed if the camera is unable to detect outlines. In this case focus can be checked by zooming in on the view through the lens in the display.

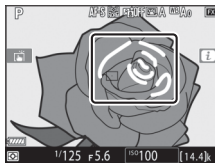

## Exposure-Related Settings (Metering and Exposure Compensation)

### Choosing How the Camera Sets Exposure

Metering determines how the camera sets exposure. Choose the method used and area metered when the camera sets exposure.

Option	Description
☑ [Matrix metering]	Produces natural results in most situations. The camera meters a wide area of the frame and sets exposure according to tone distribution, color, composition, and distance for results close to those seen by the naked eye.
☑ [Center-weighted metering]	The camera meters the entire frame but assigns the greatest weight to an area in the center. Choose for shots in which, for example, the main subject occupies a large area at the center of the frame. <ul style="list-style-type: none"><li>• [Center-weighted metering] is also recommended when using filters with an exposure factor (filter factor) over 1×.</li><li>• The size of the area assigned the greatest weight can be selected using Custom Setting b6 [Center-weighted area]. If a non-CPU lens or an AF-S Fisheye NIKKOR 8–15mm f/3.5–4.5E ED lens is attached, the camera uses an area equivalent to a circle 12 mm in diameter.</li></ul>

Option	Description
<input type="checkbox"/> [Spot metering]	<p>The camera meters a circle with a diameter of 4 mm/0.16 in. (equivalent to approximately 1.5% of the frame). This ensures that the subject will be correctly exposed even when the background is much brighter or darker. The metered area is centered on the current focus point. Note, however, that the camera will instead meter the center focus point if:</p> <ul style="list-style-type: none"> <li>• [Auto-area AF], [Group-area AF (C1)], or [Group-area AF (C2)] is selected for AF-area mode, or</li> <li>• a non-CPU lens or an AF-S Fisheye NIKKOR 8–15mm f/3.5–4.5E ED lens is attached.</li> </ul>
<input type="checkbox"/> * [Highlight-weighted metering]	<p>The camera assigns the greatest weight to highlights. Use this option to reduce loss of detail in highlights, for example when photographing spotlight performers on stage.</p>

## ■ Choosing a Metering Option

Hold the  button and rotate the main command dial. The selected option is displayed in the viewfinder and top control panel.

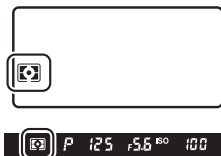
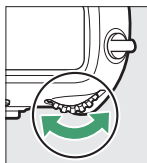
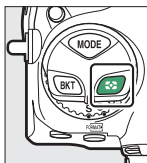



---

### [Matrix Metering] and Lens Type

The metering method used when matrix metering is selected varies with the lens.

- **CPU lenses:**

- **3D color matrix metering III:** Available with type D, E, and G CPU lenses. The camera includes distance information when calculating exposure.
- **Color matrix metering III:** Available with CPU lenses of types other than D, E, and G. Distance information is not included.

- **Non-CPU lenses:**

- Color matrix metering is available if lens data are provided using the [Non-CPU lens data] option in the setup menu. [Center-weighted metering] will be used if lens data are not provided.

### [Highlight-Weighted Metering] and Lens Type

[Center-weighted metering] will be used if [Highlight-weighted metering] is selected when non-CPU lenses and certain CPU lenses (AI-P NIKKOR lenses and AF lenses of types other than D, E, or G) are attached.

---

## Choosing an Exposure Mode

To choose an exposure mode, hold the **MODE** button and rotate the main command dial. The selected option is displayed in the top control panel.

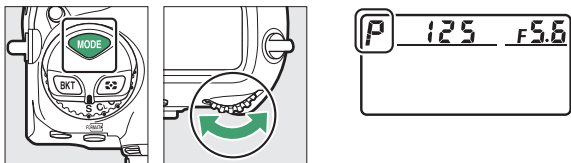

	Mode	Description
<b>P</b>	<b>Programmed auto</b> (📖 184)	Use for snapshots and in other situations in which there is little time to adjust camera settings. The camera chooses both shutter speed and aperture automatically.
<b>S</b>	<b>Shutter-priority auto</b> (📖 185)	Use to freeze or blur motion. You choose the shutter speed; the camera adjusts aperture automatically.
<b>A</b>	<b>Aperture-priority auto</b> (📖 186)	Use to blur backgrounds or bring both foreground and background into focus. You choose the aperture; the camera adjusts shutter speed automatically.
<b>M</b>	<b>Manual</b> (📖 188)	You control both shutter speed and aperture. Choose a shutter speed of "Bulb" or "Time" for long time-exposures.

---

### ✔ Lens Types

- When using a CPU lens of a type other than G or E, lock the aperture ring at the minimum aperture (highest f-number).
  - Mode **A** will be selected automatically if a non-CPU lens is attached in mode **P** or **S**.
-

## ■ P (Programmed Auto)

In this mode, the camera automatically adjusts shutter speed and aperture according to a built-in program to ensure optimal exposure in most situations. You also have the option of choosing different combinations of shutter speed and aperture without altering exposure (“flexible program”).

---

### ✔ Flexible Program

Mode **P** offers “flexible program”, in which although the camera chooses the initial shutter speed and aperture, the main command dial can (while the standby timer is on) be rotated to select different combinations without altering exposure from the value chosen by the camera. While flexible program is in effect, a flexible program indicator (“\*”) appears in the viewfinder and top control panel.

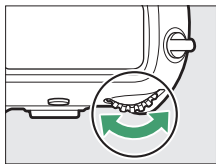

- To restore default shutter speed and aperture settings, rotate the dial until the flexible program indicator is no longer displayed. The default shutter speed and aperture are also restored when you turn the camera off or select another mode.

## ■ S (Shutter-Priority Auto)

In shutter-priority auto, you choose the shutter speed while the camera automatically adjusts aperture for optimal exposure. Choose fast shutter speeds to “freeze” motion, slow shutter speeds to suggest motion by blurring moving objects. To choose a shutter speed, rotate the main command dial while the exposure meters are on.

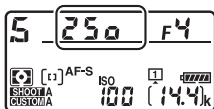
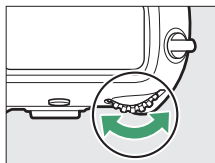

- Shutter speed can be set to “x 250” or to values between  $\frac{1}{8000}$  s (8000) and 30 s (30’).
- Shutter speed can be locked at the selected value (📖 194).

## ■ A (Aperture-Priority Auto)

In aperture-priority auto, you choose the aperture while the camera automatically adjusts shutter speed for optimal exposure. To adjust aperture, rotate the sub-command dial while the exposure meters are on.

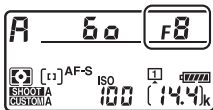
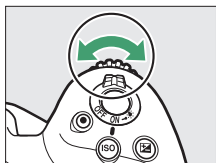

- The minimum and maximum values for aperture vary with the lens.
- Aperture can be locked at the selected value (📖 194).

---

## Non-CPU Lenses

If when using a non-CPU lens you enter its maximum aperture using the [Non-CPU lens data] item in setup menu, the current f-number will be displayed in the viewfinder and top control panel. Use the lens aperture ring to adjust aperture. Although other values can be selected, the value shown in the displays will be rounded to the nearest full aperture stop.

- If you do not supply the maximum aperture, the aperture displays in the viewfinder and top control panel will show only the number of stops ( $\Delta F$ , with maximum aperture displayed as  $\Delta F0$ ) and the f-number must be read from the lens aperture ring.

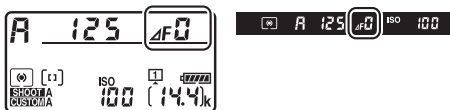

## Depth-of-Field Preview

Aperture can be stopped down by pressing and holding the **Pv** button. Depth of field (the range of distances that appears to be in focus) can then be previewed in the viewfinder.

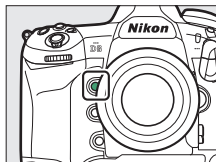

## ■ M (Manual)

You control both shutter speed and aperture. Choose this mode for long time-exposures of such subjects as fireworks or the night sky (“Bulb” or “Time” photography, [□ 191](#)). Shutter speed and aperture can be adjusted with reference to the exposure indicators by rotating the command dials as follows while the standby timer is on:

- Rotate the main command dial to choose the shutter speed. Shutter speed can be set to values between  $1/8000$  s (**8000**) and 30 s (**30'**), to **b u l b** (“Bulb”) or **- -** (“Time”), or to **x 250**.
- Aperture can be adjusted by rotating the sub-command dial.
- The minimum and maximum values for aperture vary with the lens.
- Shutter speed and aperture can be locked at the selected values ([□ 194](#)).

### Aperture:

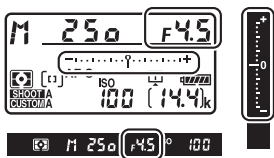



## Shutter speed:

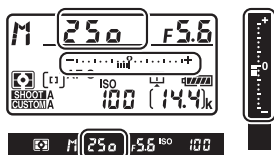
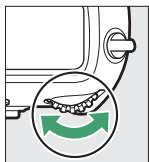

---

### **Extended Shutter Speeds**







For shutter speeds as slow as 900 s (15 minutes), select **[On]** for Custom Setting d7 **[Extended shutter speeds (M)]**.

### **AF Micro NIKKOR Lenses**

Users of external exposure meters need not take the exposure ratio into account when adjusting aperture via the sub-command dial. Users will however need to consider the exposure ratio when using the lens aperture ring.

## Exposure Indicators

The exposure indicators in the viewfinder and top control panel show whether the photograph would be under- or over-exposed at current settings. The exposure indicators can be read as follows (the display varies with the option selected for Custom Setting b2 [**EV steps for exposure cntrl**]):

Display	[1/3 step] selected for [EV steps for exposure cntrl]		
	Optimal exposure	Underexposed by 1/3 EV	Overexposed by over 3 1/3 EV
Top control panel			
Viewfinder			

- The orientation of the exposure indicators can be reversed using Custom Setting f9 [**Reverse indicators**].

## Exposure Warning

The displays will flash if the selected settings exceed the limits of the exposure metering system or the exposure limits for live view.

---

## Long Time-Exposures (Mode M Only)

The camera offers two options for long time-exposures: “Bulb” and “Time”. Long time-exposures can be used for pictures of fireworks, night scenery, the stars, or moving lights.



A 35-second exposure shot at a shutter speed of “Bulb” and an aperture of  $f/25$

Shutter speed	Description
Bulb	The shutter remains open while the shutter-release button is held down.
Time	The exposure starts when the shutter-release button is pressed and ends when the button is pressed a second time.

- To prevent blur, use a tripod or a device such as an optional wireless remote controller or remote cord that can be used to operate the shutter remotely.

**1** Keep the camera steady, for example by using a tripod.

**2** Hold the **MODE** button and rotate the main command dial to select mode **M**.

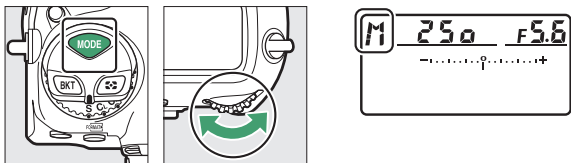

**3** Rotate the main command dial to choose a shutter speed of **bULB** ("Bulb") or **- -** ("Time").

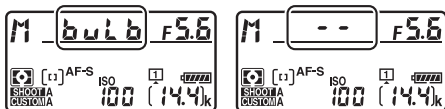

Note that the exposure indicators are not displayed at a shutter speed of **bULB** or **- -**.

---

## 4 Focus and start the exposure.

- **“Bulb”**: Press the shutter-release button all the way down to start the exposure. Keep the shutter-release button pressed during the exposure.
- **“Time”**: Press the shutter-release button all the way down to start the exposure.

---

## 5 End the exposure.

- **“Bulb”**: Lift your finger from the shutter-release button.
- **“Time”**: Press the shutter-release button all the way down a second time.

---

### Long Time-Exposures

- To prevent light entering via the viewfinder from appearing in the photograph or interfering with exposure, raise the viewfinder eyepiece shutter lever to close the viewfinder eyepiece shutter before pressing the shutter-release button to start the exposure (📖 13).
  - Note that “noise” (bright spots, randomly-spaced bright pixels or fog) may be present in long exposures.
  - Bright spots and fog can be reduced by choosing **[On]** for **[Long exposure NR]** in the photo shooting menu.
  - Nikon recommends using a fully-charged battery or an optional AC adapter and power connector to prevent loss of power during long exposures.
-

## Shutter Speed and Aperture Lock

You can lock shutter speed (mode **S**), aperture (mode **A**), or both shutter speed and aperture (mode **M**).

Shutter speed and aperture lock are not available in mode **P**.

---

### **1 Assign [Shutter spd & aperture lock] to a control using Custom Setting f3 [Custom controls].**

---

### **2 Lock shutter speed and/or aperture.**

#### **Shutter speed:**

- After confirming that camera is in mode **S** or **M**, press the control to which **[Shutter spd & aperture lock]** has been assigned and rotate the main command dial until  (shutter-speed lock) icons appear in the viewfinder and top control panel.

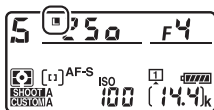

- To unlock shutter speed, press the control to which **[Shutter spd & aperture lock]** has been assigned and rotate the main command dial until the  icons are no longer displayed.

## Aperture:

- After confirming that camera is in mode **A** or **M**, press the control to which [**Shutter spd & aperture lock**] has been assigned and rotate the sub-command dial until **L** (aperture lock) icons appear in the viewfinder and top control panel.

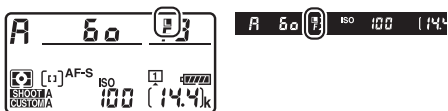

- To unlock aperture, press the control to which [**Shutter spd & aperture lock**] has been assigned and rotate the sub-command dial until the **L** icons are no longer displayed.

## **Autoexposure Lock**

Use autoexposure lock to recompose photographs after setting exposure for a specific area of the subject. Exposure lock comes in handy when the area used to set exposure is much brighter or darker than its surroundings.

---

### **1 Select [Center-weighted metering] or [Spot metering] (📖 178).**

---

### **2 With the subject positioned in the selected focus point and the shutter-release button pressed halfway, press the center of the sub-selector to lock exposure.**

- While the center of the sub-selector is pressed, exposure will lock at the value metered in an area of the subject determined by the selected metering option.
- An **AE-L** icon will be displayed in the viewfinder.

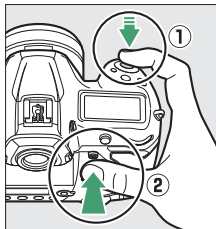



- If you are using autofocus, you should also confirm that the in-focus indicator (●) is displayed.

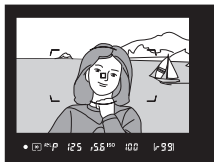

### 3 Keeping the center of the sub-selector pressed, recompose the photograph and shoot.

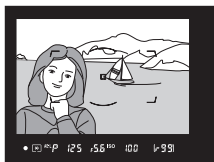

#### Locking Exposure with the Shutter-Release Button

If **[On (half press)]** is selected for Custom Setting c1 **[Shutter-release button AE-L]**, exposure will lock while the shutter-release button is pressed halfway.

### **Metered Area**

- In [**Spot metering**], exposure will be locked at the value metered in a circle centered on the current focus point (☐ 178).
- In [**Center-weighted metering**], exposure will be locked at the value metered in a 12-mm circle in the center of the viewfinder.

### **Adjusting Shutter Speed and Aperture**

The following settings can be adjusted while the center of the sub-selector is pressed:

<b>Mode</b>	<b>Setting</b>
<b>P</b>	Shutter speed and aperture (flexible program; ☐ 184)
<b>S</b>	Shutter speed
<b>A</b>	Aperture

- The new values can be confirmed in the viewfinder and top control panel.
- The option selected for metering cannot be changed while exposure lock is in effect.

## Exposure Compensation

Exposure compensation is used to alter exposure from the value suggested by the camera. It can be used to make pictures brighter or darker. It is most effective when used with **[Spot metering]** or **[Center-weighted metering]** (📖 178).



-1 EV



No exposure  
compensation



+1 EV

## ■ Adjusting Exposure Compensation





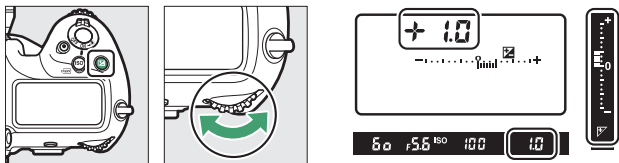

Hold the  button and rotate the main command dial.

- The selected value is displayed in the viewfinder and top control panel.



- Choose from values between  $-5$  EV (underexposure) and  $+5$  EV (overexposure).
- By default, changes are made in increments of  $1/3$  EV. The size of the increments can be changed using Custom Setting b3 [**Exp./flash comp. step value**].
- In general, positive values make the subject brighter while negative values make it darker.

- The current value is displayed in the viewfinder and top control panel when the  button is pressed.

Display	No exposure compensation (  button pressed)	-0.3 EV	+2 EV
Top control panel			
Viewfinder			

-  icons and exposure indicators appear in the viewfinder and top control panel. In modes other than **M**, the zero (“0”) at the center of the exposure indicator flashes.

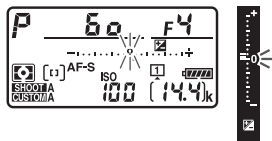

- Normal exposure can be restored by setting exposure compensation to  $\pm 0.0$ . Exposure compensation is not reset when the camera is turned off.

---

### **Mode M**

In mode **M**, exposure compensation affects only the exposure indicator; shutter speed and aperture do not change.

### **Using a Flash**

When an optional flash is used, exposure compensation affects both flash level and exposure, altering the brightness of both the main subject and the background; if desired, the effect can be restricted to the background using Custom Setting e3 [**Exposure comp. for flash**].

---

## Choosing the Operation Performed When the Shutter Is Released (Release Mode)





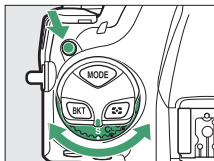

### Choosing a Release Mode Such as Single-Frame, Continuous, or Quiet Shutter-Release

To choose the operation performed when the shutter-release button is pressed all the way down, hold the release mode dial lock release and rotate the release mode dial.



- Stop when the pointer aligns with the desired setting.



Mode		Description
S	<b>Single frame</b>	The camera takes one photograph each time the shutter-release button is pressed.
CL	<b>Continuous low speed</b>	The camera takes photographs at a selected rate while the shutter-release button is pressed. <ul style="list-style-type: none"><li>• Choose from rates of from 1 to 10 fps.</li><li>• To choose the frame rate, hold the  button and rotate the sub-command dial.</li></ul>

Mode		Description
CH	<b>Continuous high speed</b>	<p>The camera takes photographs at a selected rate while the shutter-release button is pressed. Use for active subjects.</p> <ul style="list-style-type: none"> <li>• Choose from rates of from 10 to 14 fps.</li> <li>• To choose the frame rate, hold the  button and rotate the sub-command dial.</li> </ul>
Q	<b>Quiet shutter release</b>	<p>The mirror stays raised while the shutter-release button is fully pressed. Not only can you control the timing of the click made when the mirror is lowered, but the click itself is quieter than in single-frame mode.</p> <ul style="list-style-type: none"> <li>• No beep will sound, regardless of the option chosen for [Beep options] &gt; [Beep on/off] in the setup menu.</li> <li>• Burst shooting can be enabled by holding the  button and rotating a command dial. <ul style="list-style-type: none"> <li>-  is displayed in the rear control panel when burst shooting is enabled.</li> <li>- Choose from rates of from 1 to 5 fps.</li> </ul> </li> </ul>
	<b>Self-timer</b>	Take pictures with the self-timer (  209).
MUP	<b>Mirror up</b>	Choose this mode to prevent blur caused by vibrations produced when the mirror is raised (  211). You may find this beneficial when using telephoto lenses and during close-up photography.



Mode	Description
 <b>Quick release-mode selection</b>	Hold the  button and rotate the main command dial to select the release mode (  208).

### ✔ Frame Advance Rate

- The frame rates for **CL** and **CH** modes and for burst photography in mode **Q** can also be selected using Custom Setting d1 [**Continuous shooting speed**].
- The maximum frame advance rate when [**On**] is selected for [**Silent live view photography**] during live view is approximately 10.5 fps, even if rates of from 11 to 14 fps are selected in **CH** mode.
- The figures for frame advance rate apply in mode **S** or **M** at shutter speeds of  $\frac{1}{250}$  s or faster with **AF-C** selected for autofocus mode and other settings at default values. Frame advance rates may slow:
  - at slow shutter speeds,
  - when [**On**] is selected for [**ISO sensitivity settings**] > [**Auto ISO sensitivity control**] in the photo shooting menu and ISO sensitivity is altered automatically by the camera,
  - if flicker is detected with [**Enable**] selected for [**Flicker reduction**] > [**Flicker reduction setting**] in the photo shooting menu,
  - at extremely small apertures (high f-numbers),
  - when vibration reduction (available with VR lenses) is on,
  - when the battery is low,
  - with certain lenses, or
  - if a non-CPU lens is attached with [**Aperture ring**] selected for Custom Setting f6 [**Customize command dials**] > [**Aperture setting**].

### ✔ **Burst Photography**

- Depending on shooting conditions and memory card performance, the memory card access lamp may light for anywhere from a few tens of seconds to around a minute. Do not remove the memory card while the memory card access lamp is lit. Not only could any unrecorded images be lost, but the camera or memory card could be damaged.
  - If the camera is switched off while the memory card access lamp is lit, it will not power off until all images in the buffer have been recorded.
  - If the battery is exhausted while images remain in the buffer, the shutter release will be disabled and the images transferred to the memory card.
-

---



## The Memory Buffer

- While the shutter-release button is pressed halfway, the frame-count display will show the number of pictures that can be stored in the memory buffer.



- When the buffer is full, the display will show **r00** and the frame rate will drop.
  - The number shown is approximate. The actual number of photos that can be stored in the memory buffer varies with camera settings and shooting conditions.
  - Memory buffer capacity may drop briefly immediately after the camera is turned on.
  - Memory buffer capacity can be viewed in the monitor during live view.
-

## ■ Quick Release-Mode Selection

With the release mode dial rotated to , you can choose a release mode by holding the  button and rotating the main command dial.

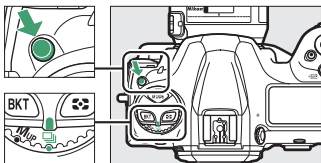

- Settings for the selected mode can be adjusted by holding the  button and rotating the sub-command dial.

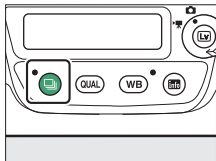

- The selected options are shown in the rear control panel.



## Using the Self-Timer (☺)

- 1 Rotate the release mode dial to ☺ (self-timer mode).**

Hold the release mode dial lock release and rotate the release mode dial to ☺.

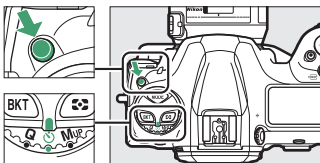

- 2 Frame the photograph and focus.**

The timer will not start if the shutter cannot be released, as may be the case, for example, if the camera is unable to focus when **AF-S** is selected for autofocus mode.



---

### 3 Start the timer.

- Press the shutter-release button all the way down to start the timer; the shutter will be released after about 10 seconds, during which the self-timer lamp will at first flash for approximately 8 seconds and then light for roughly 2 seconds.
- To turn the self-timer off before a photograph is taken, turn the release mode dial to another setting.
- The timer duration, the number of shots taken, and the interval between shots can be selected using Custom Setting c3 [**Self-timer**].



---

#### Setting the Timer

To choose the timer duration, press and hold the  button and rotate a command dial to choose from values of 20, 10, 5, or 2 seconds. The selected option is displayed in the rear control panel.



## Mirror Up Mode (MUP)

Choose this mode to minimize blurring caused by vibrations produced as the mirror is raised.

- Hold the release mode dial lock release and rotate the release mode dial to **MUP** (mirror up).

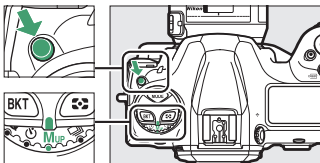

- After pressing the shutter-release button halfway to set focus and exposure, press the shutter-release button the rest of the way down to raise the mirror. **rdy** will be displayed in the control panels.



- Press the shutter-release button all the way down a second time to take the picture.

---

### ✔ **Mirror Up**

- Photos cannot be framed in the viewfinder.
  - Autofocus and metering are not available.
- 

### ✔ **Taking Pictures**

- Use of a tripod is recommended.
  - Press the shutter-release button smoothly to prevent blur.
  - The mirror lowers when shooting ends.
  - A picture will be taken automatically if no operations are performed for about 30 s after the mirror is raised.
  - In live view, the picture is taken the first time the shutter-release button is pressed all the way down.
-



# Adjusting the Camera's Sensitivity to Light (ISO Sensitivity)

## ISO Sensitivity

The camera's sensitivity to light (ISO sensitivity) can be adjusted according to the amount of light available. In general, choosing higher values allows faster shutter speeds at the same aperture. Choose from settings of from ISO 100 to 102400. Extended settings of from about 0.3 to 1 EV below ISO 100 and 0.3 to 5 EV above ISO 102400 are also available.

### ■ Adjusting ISO Sensitivity

Hold the **ISO** (FORMAT) button and rotate the main command dial.

- The selected option is displayed in the viewfinder and top control panel.

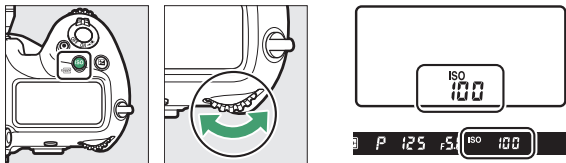

- By default, changes are made in increments of  $\frac{1}{3}$  EV. The size of the increments can be changed using Custom Setting b1 [ISO sensitivity step value].

## ✔ The Photo Shooting Menu [ISO Sensitivity Settings] Option

ISO sensitivity can also be adjusted using the [ISO sensitivity settings] item in the photo shooting menu.



## ✔ High ISO Sensitivities

The higher the ISO sensitivity, the less light needed to make an exposure, allowing pictures to be taken when lighting is poor and helping prevent blur when the subject is in motion. Note, however, that the higher the sensitivity, the more likely the image is to be affected by “noise” in the form of randomly-spaced bright pixels, fog, or lines.

- “Noise” can be reduced by enabling high ISO noise reduction. High ISO noise reduction can be enabled using the [High ISO NR] items in the photo and movie shooting menus.

### **Hi 0.3–Hi 5**

A setting of [**Hi 0.3**] corresponds to an ISO sensitivity approximately 0.3 EV higher than ISO 102400 (ISO 128000) and [**Hi 5.0**] to an ISO sensitivity approximately 5 EV higher (ISO 3280000). Note that pictures taken at these settings are particularly prone to “noise” in the form of randomly-spaced bright pixels, fog, or lines.

### **Lo 0.3–Lo 1**

[**Lo 0.3**] corresponds to an ISO sensitivity about 0.3 EV below ISO 100 (equivalent to ISO 80). [**Lo 1.0**] is roughly 1 EV below ISO 100 (ISO 50). Use for larger apertures or slower shutter speeds when lighting is bright. Highlights may be overexposed. In most cases, ISO sensitivities of ISO [**100**] or above are recommended.

---

## Auto ISO Sensitivity Control

Auto ISO sensitivity control automatically adjusts ISO sensitivity if optimal exposure cannot be achieved at the value selected by the user.

### ■ Enabling Auto ISO Sensitivity Control

- 1 Select [ISO sensitivity settings] in the photo shooting menu, highlight [Auto ISO sensitivity control] and press .**

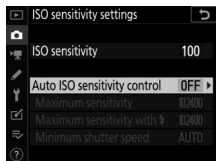

- 2 Select [On].**

- Highlight **[On]** and press  to enable auto ISO sensitivity control. If a flash is used, ISO sensitivity will be adjusted appropriately.
- If **[Off]** is selected, **[ISO sensitivity]** will remain fixed at the value selected by the user.

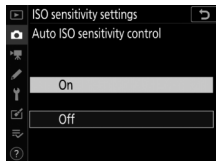

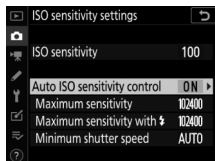

### 3 Adjust settings.

- Adjust auto ISO sensitivity control settings.



Option	Description
[Maximum sensitivity]	To prevent ISO sensitivity being raised too high, you can select an upper limit for ISO sensitivity control; choose from values of from ISO 200 to Hi 5. The minimum value that will be selected using auto ISO sensitivity control is ISO 100.
[Maximum sensitivity with flash]	Choose the maximum ISO sensitivity for flash photography; options range from ISO 200 to Hi 5. Selecting [ <b>Same as without flash</b> ] sets the maximum ISO sensitivity for flash photography to the value currently selected for [ <b>Maximum sensitivity</b> ].

Option	Description
<p><b>[Minimum shutter speed]</b></p>	<p>In modes <b>P</b> and <b>A</b>, auto ISO sensitivity control only takes effect if the shutter speed needed for optimal exposure would fall below this value; choose from settings of <math>1/4000</math> s to 30 s. If <b>[Auto]</b> is selected, the camera will choose the minimum shutter speed based on lens focal length (CPU lenses only). For example, the camera will automatically choose faster minimum shutter speeds to prevent blur caused by camera shake when a long lens is attached.</p> <ul style="list-style-type: none"> <li>• To view auto shutter-speed selection options, highlight <b>[Auto]</b> and press . Auto shutter-speed selection can be fine-tuned by choosing faster or slower minimums. Faster settings can be used to reduce blur when photographing fast-moving subjects.</li> <li>• Shutter speeds may drop below the selected minimum if optimal exposure cannot be achieved at the ISO sensitivity chosen for <b>[Maximum sensitivity]</b>.</li> </ul>

- Press  to save changes.

When [On] is selected for [Auto ISO sensitivity control], **ISO AUTO** indicators will appear in the viewfinder and top control panel. When these indicators are lit (not flashing), pictures will be taken at the sensitivity selected for [ISO sensitivity]. When sensitivity is altered from the value selected by the user, the **ISO AUTO** indicators will flash and the altered value will be shown in the displays.

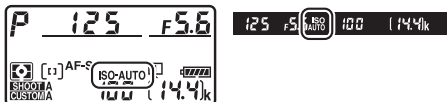



---

## ✓ Auto ISO Sensitivity Control

- If value currently selected for **[ISO sensitivity]** is higher than that chosen for **[Maximum sensitivity]**, the value chosen for **[ISO sensitivity]** will serve as the upper limit for auto ISO sensitivity control.
- During flash photography, shutter speed is limited to the range defined by the values selected for Custom Settings e1 **[Flash sync speed]** and e2 **[Flash shutter speed]**. If the value selected for **[Minimum shutter speed]** is not in this range, the value selected for Custom Setting e2 **[Flash shutter speed]** becomes the effective minimum shutter speed.
- If a non-CPU lens is used without lens data, the minimum shutter speed will be fixed at  $1/30$  s.
- If an optional flash unit is attached, ISO sensitivity may be raised automatically when auto ISO sensitivity control is used in combination with slow sync flash modes, possibly preventing the camera from selecting slow shutter speeds.

---

## ✓ Turning Auto ISO Sensitivity Control On or Off

You can also turn **[Auto ISO sensitivity control]** on or off by holding the **ISO** () button and rotating the sub-command dial ( 116).

---





# Achieving Natural Colors with Different Light Sources (White Balance)

## White Balance

Adjusting settings for natural colors under different light sources is referred to as “matching white balance to the light source”. The default setting (AUTO) is suitable for use with most light sources, but if it fails to produce the desired results, other settings can be selected according to the weather or light source.

Option	Color temperature *	Description
AUTO [Auto]		The camera adjusts white balance for optimal results with most light sources. If an optional flash unit is used, white balance will be adjusted in accord with the conditions in effect when the flash fires.

Option	Color temperature *	Description
AUTO0 [Keep white (reduce warm colors)]	Approx. 3500–8000 K	Eliminate the warm color cast produced by incandescent lighting.
AUTO1 [Keep overall atmosphere]	Approx. 3500–8000 K	Partially preserve the warm color cast produced by incandescent lighting.
AUTO2 [Keep warm lighting colors]	Approx. 3500–8000 K	Preserve the warm color cast produced by incandescent lighting.
☀️A [Natural light auto]	Approx. 4500–8000 K	White balance is adjusted for non-artificial light sources, producing more life-like colors than does [Auto] when used under natural light.
☀️ [Direct sunlight]	Approx. 5200 K	Use with subjects lit by direct sunlight.
☁️ [Cloudy]	Approx. 6000 K	Use in daylight under overcast skies.
🏠 [Shade]	Approx. 8000 K	Use in daylight with subjects in shade.
💡 [Incandescent]	Approx. 3000 K	Use under incandescent lighting.

Option	Color temperature *	Description
 [Fluorescent]		Use under fluorescent lighting; choose bulb type according to light source.
[Sodium-vapor lamps]	Approx. 2700 K	
[Warm-white fluorescent]	Approx. 3000 K	
[White fluorescent]	Approx. 3700 K	
[Cool-white fluorescent]	Approx. 4200 K	
[Day white fluorescent]	Approx. 5000 K	
[Daylight fluorescent]	Approx. 6500 K	
[High temp. mercury-vapor]	Approx. 7200 K	
 [Flash]	Approx. 5400 K	Use for flash photography.
 [Choose color temperature]	Approx. 2500–10,000 K	Direct color-temperature selection. <ul style="list-style-type: none"> <li>• To choose a color temperature, hold the <b>WB</b> button and rotate the sub-command dial.</li> </ul>

Option	Color temperature *	Description
PRE [Preset manual]		Measure white balance directly from a subject or light source or copy white balance from an existing photograph. <ul style="list-style-type: none"> <li>• To choose a white balance preset, hold the <b>WB</b> button and rotate the sub-command dial.</li> <li>• To enter direct measurement mode, press and hold the <b>WB</b> button (☐ 234).</li> </ul>

\* Values when fine-tuning is set to 0.

### ✔ Auto

- The photo info [Basic shooting data] page for pictures shot with [Auto] or [Natural light auto] selected for white balance lists the color temperature selected by the camera at the time the picture was taken (☐ 410). You can use this as reference when choosing a value for [Choose color temperature].
- To view the [Basic shooting data] page during playback, go to [Playback display options] in the playback menu and place checks (☑) next to [Shooting data] and [Basic shooting data].

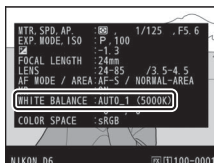

## ■ Choosing a White Balance Option

To choose a white balance option, hold the **WB** button and rotate the main command dial. The selected option is displayed in the rear control panel.

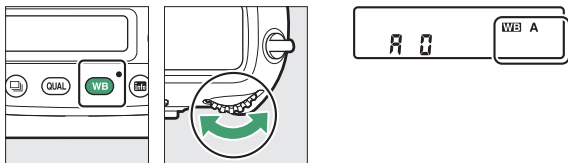

Options for the selected setting, if any, can be selected by holding the **WB** button and rotating the sub-command dial.

---

### ✓ Studio Flash Lighting

[Auto] may not produce the desired results with large studio flash units. Use preset white balance or set white balance to **[Flash]** and use fine-tuning to adjust white balance.

---

## ✓ The [White Balance] Options

White balance can also be adjusted from the photo and movie shooting menus.



## ✓ [Natural Light Auto]

[Natural light auto] may not produce the desired results under artificial light. Choose [Auto] or an option that matches the light source.

## ✓ Color Temperature

The perceived color of a light source varies with the viewer; some may have a red cast while others appear blue. Color temperature is an objective measure of the color of a light source, expressed in Kelvins (K). The lower the color temperature, the redder the cast (①); the higher the temperature, the bluer the cast (②).

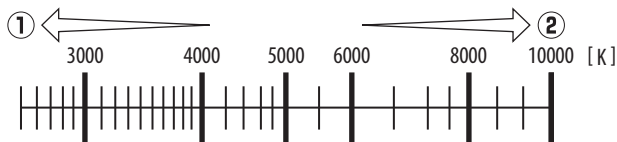

## ✓ Choosing a Color Temperature

In general, choose lower values if your pictures have a red cast or to intentionally make pictures bluer, higher values if your pictures are tinged blue or to intentionally make pictures redder.

## Fine-Tuning White Balance

- 1 Select [White balance] in the photo shooting menu, highlight the desired option, and press  as often as necessary to display fine-tuning options.

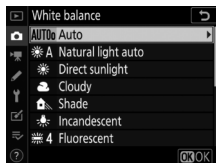

For information on fine-tuning [**Preset manual**] white balance, see “Fine-Tuning Preset Manual White Balance” (📖 248).

---

## 2 Fine-tune white balance.

- Use the multi selector to position the cursor on the grid. The cursor can be moved up to six steps from the center along either of the A (amber)–B (blue) and G (green)–M (magenta) axes. The selected value is displayed to the right of the grid.
- The A (amber)–B (blue) axis corresponds to color temperature and is ruled in increments of 0.5. A change of 1 is equivalent to approximately 5 mired.
- The G (green)–M (magenta) axis has effects similar to color compensation filters and is ruled in increments of 0.25. A change of 1 is equivalent to approximately 0.05 diffuse density units.

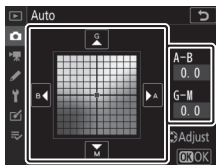

---

## 3 Save changes.

- Press **OK** to save changes and exit to the menus.
- If white balance has been fine-tuned, an asterisk (“\*”) will be displayed in the rear control panel.





## The Information Display

During viewfinder photography, you can press the **WB** button to adjust white balance settings in the information display.

- Rotate the main command dial to choose the white balance mode. When [**Auto**] or [**Fluorescent**] is selected, you can choose an [**Auto**] or [**Fluorescent**] sub-option by rotating the sub-command dial.
- When [**Choose color temperature**] is selected, you can rotate the sub-command dial to choose the color temperature.
- When [**Preset manual**] is selected, you can rotate the sub-command dial to choose a white balance preset.
- In modes other than [**Choose color temperature**] and [**Preset manual**], you can use the multi-selector to fine-tune white balance on the A (amber)–B (blue) and G (green)–M (magenta) axes.

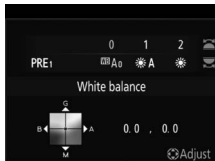

## Adjusting White Balance in Live View

White balance settings can be displayed by pressing the **WB** button during live view.

- The procedures for choosing a white balance mode and fine-tuning white balance are the same as in the information display.
- The effects can be previewed in the monitor.

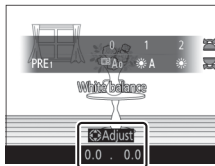

## ✔ **White Balance Fine-Tuning**

The colors on the fine-tuning axes are relative, not absolute. Selecting more of a color on a given axis does not necessarily result in that color appearing in pictures. For example, moving the cursor to B (blue) when a “warm” setting such as [**Incandescent**] is selected will make pictures slightly “colder” but will not actually make them blue.

## ✔ **“Mired”**

Values in mired are calculated by multiplying the inverse of the color temperature by  $10^6$ . Any given change in color temperature produces a greater difference in color at low color temperatures than it would at higher color temperatures. For example, a change of 1000 K produces a much greater change in color at 3000 K than at 6000 K. Mired is a measure of color temperature that takes such variation into account, and as such is the unit used in color-temperature compensation filters.

E.g.: Change in color temperature (in Kelvin): Value in mired

- 4000 K–3000 K = 1000 K: 83 mired
  - 7000 K–6000 K = 1000 K: 24 mired
-









# Choosing a Color Temperature

## ■ Using the Menus

Choose a color temperature by entering values for the A (amber)–B (blue) and G (green)–M (magenta) axes.

**1 Select [White balance] in the photo shooting menu, then highlight [Choose color temperature] and press .**

**2 Choose a color temperature.**

- Press  or  to highlight digits on the amber (A)–blue (B) axis and press  or  to change.
- Press  or  to highlight the value for the green (G)–magenta (M) axis and press  or  to change.

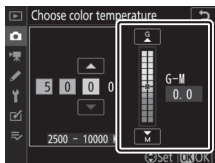
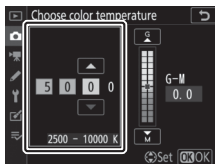

---

### 3 Save changes.

- Press **OK** to save changes and exit to the menus.
- If a value other than 0 is selected for the green (G)–magenta (M) axis, an asterisk (“\*”) will appear in the rear control panel.

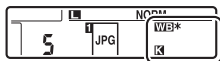

## ■ Using Buttons (Amber–Blue Only)

To adjust color temperature when [**Choose color temperature**] is selected for white balance, hold the **WB** button and use the multi selector or rotate the sub-command dial.

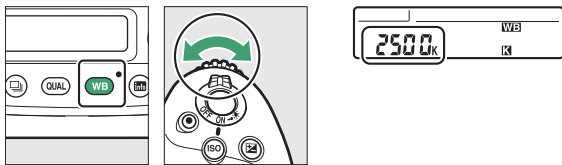

- Hold the **WB** button and rotate the sub-command dial to choose a color temperature in mireds.
- To highlight a digit, hold the **WB** button and press  $\odot$  or  $\ominus$ . Press  $\odot$  or  $\ominus$  to edit the highlighted digit.
- Changes apply only to the A (amber)–B (blue) axis.
- The selected setting takes effect when the **WB** button is released.

---

### ✔ Color-Temperature Selection

- Do not use color-temperature selection with flash lighting or fluorescent light sources; instead, use the [**Fluorescent**] or [**Flash**] option, respectively.
  - When using color-temperature selection with other light sources, take a test shot to determine if the selected value is appropriate.
-

## **Preset Manual**

Preset manual is used to record and recall custom white balance values measured under specific lighting or copied from a photograph. It is recommended under mixed lighting or lighting with a strong color cast or whenever settings such as **[Auto]**, **[Incandescent]**, and color-temperature selection fail to produce the desired results.

The camera can store up to six values for preset white balance in presets d-1 through d-6. Two methods are available for setting preset white balance:

<b>Method</b>	<b>Description</b>
<b>Direct measurement</b>	Measure white balance from a white or neutral gray object under the lighting for the final shot (☐ 235). During live view, white balance can be measured in a selected area of the frame (spot white balance, ☐ 241).
<b>Copying a value from existing photograph</b>	Copy white balance from a photo on a memory card (☐ 246).

---

### **White Balance Presets**

Changes to white balance presets d-1 through d-6 apply to all photo shooting menu banks (A–D). For example, changes to presets made when photo shooting menu bank A is selected also apply to photo shooting menu banks B through D.

---

## ■ Viewfinder Photography

### Before Measuring White Balance:

- Place a neutral gray or white object under the lighting that will be used in the final photograph. In studio settings, a standard 18% gray panel can be used as a reference object.
- Note that exposure is automatically increased by 1 EV when white balance is measured using a neutral gray or white reference object. In mode **M**, adjust exposure so that the exposure indicator shows  $\pm 0$  (📖 190).

### 1 Hold the WB button and rotate the main command dial to select PRE.

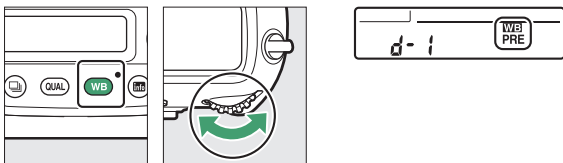

## 2 Select a preset.

Hold the **WB** button and rotate the sub-command dial until the desired white balance preset (d-1 to d-6) is displayed.

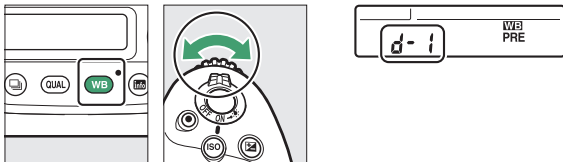

## 3 Select direct measurement mode.

- Release the **WB** button briefly and then press the **WB** button until the **PrE** indicators in the viewfinder and top control panel and the **PRE** icon in the rear control panel start to flash.

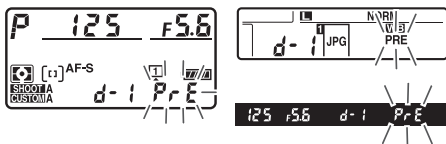



- In direct measurement mode, the focus point changes to a white balance target as shown and stays in the center of the frame.

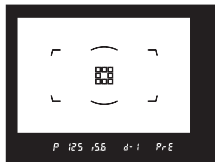

#### **4 Before the $P$ , $r$ , $E$ indicators stop flashing, photograph the reference object.**

- Position the reference object in the white balance target and press the shutter-release button all the way down to measure a value for white balance and store it in the preset selected in Step 2.
- Even if the camera is not in focus, the shutter will be released and white balance will be measured normally. No photograph will be recorded.



## 5 Check the results.

- If the camera was able to measure a value for white balance, **Good** will flash in the top and rear control panels, while the viewfinder will show a flashing **Wd**. Press the shutter-release button halfway to exit to shooting mode.

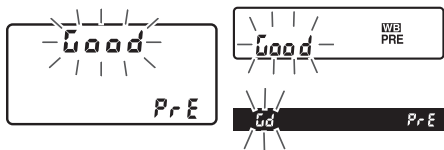

- If lighting is too dark or too bright, the camera may be unable to measure white balance. A flashing **noWd** will appear in the viewfinder and in the top and rear control panels. Press the shutter-release button halfway to return to Step 4 and measure white balance again.

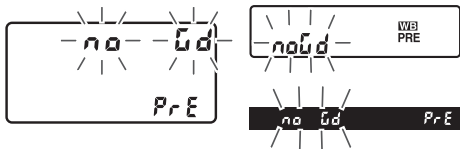

---

### ✔ **Time Limit (Viewfinder Photography)**

If no operations are performed during viewfinder photography while the displays are flashing, direct measurement mode will end in the time selected for Custom Setting c2 [**Standby timer**].

---

### ✔ **Measuring White Balance (Viewfinder Photography)**

Preset manual white balance cannot be measured during:

- multiple exposures,
- interval-timer photography,
- time-lapse movie recording, or
- focus shift.

## ✔ Protected Presets

If the current preset is protected, the camera will be unable to measure a value for preset manual white balance; any attempt to measure white balance for a protected preset will be accompanied by a flashing **P** in the viewfinder and top control panel and a flashing **OK** in the rear control panel.

## ✔ Presets

- At shipment, presets d-1 through d-6 are set to 5200 K, equivalent to the “direct sunlight” white balance option.
- White balance presets can be viewed by selecting **[White balance]** > **[Preset manual]** in the photo shooting menu. To recall a stored value, highlight a preset using the multi selector and press **OK**.

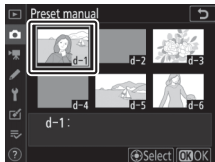

## ■ Live View (Spot White Balance)

During live view, white balance can be measured from white or gray objects in a smaller area of the frame than would be possible in viewfinder photography (spot white balance). As long as the subject contain a white or gray area, you will not have to prepare a reference object or change lenses during telephoto photography.

- When measuring preset manual white balance for flash photography, use the viewfinder as described in “Viewfinder Photography” (📖 235).

---

### 1 Hold the WB button and rotate the main command dial to select PRE.

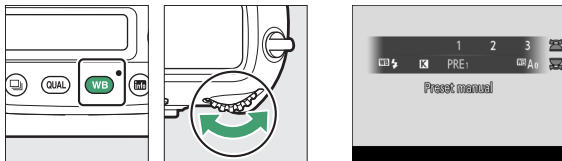

---

## 2 Select a preset.

Hold the **WB** button and rotate the sub-command dial until the desired white balance preset (d-1 to d-6) is displayed.

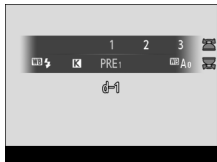
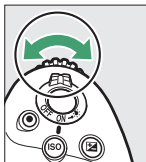
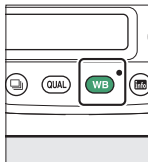

---

## 3 Select direct measurement mode.

Release the **WB** button briefly and then press the **WB** button until the **PRE** icon in the monitor starts to flash.

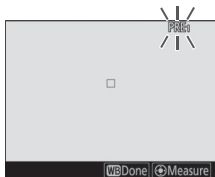

---

**4** While the PRE icon is flashing, use the multi selector to position the spot white balance target (□) over a white or gray area of the subject.

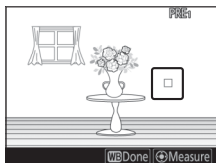

To zoom in on the area around the target (□) for more precise positioning, press the  button.

---

**5** Measure a value for preset white balance either by pressing the center of the multi selector or by pressing the shutter-release button all the way down.

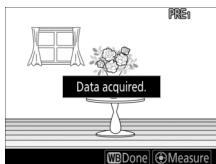

- If the camera is able to measure white balance, the new value will be reflected in the display.

- If the camera is unable to measure white balance, a message will be displayed and the camera will return to Step 4. Try measuring white balance again, for example with the target (□) positioned over a different area of the subject.



## 6 Press the WB button to exit direct measurement mode.

White balance presets can be viewed by selecting [**White balance**] > [**Preset manual**] in the photo or movie shooting menu. White frames show the positions of the targets used to measure preset white balance.

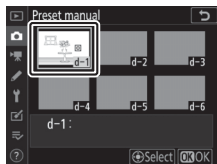



---

### ✔ Time Limit (Live View)

Direct measurement mode will end if no operations are performed in the time selected for Custom Setting c4 [Monitor off delay] > [Live view].

### ✔ Measuring White Balance (Live View)

Preset manual white balance cannot be measured when [Multiple exposure] is active or an option other than [None] is selected for [Photo live view display WB] (☐ 848).

---

### ✔ Touch Controls

In direct measurement mode, you can position the target (☐) and measure white balance by tapping the desired area in the display.

---

## ■ Copying White Balance from a Photograph

Follow the steps below to copy a value for white balance from an existing photograph to a selected preset.

- 1 Select [White balance] in the photo shooting menu, then highlight [Preset manual] and press .**

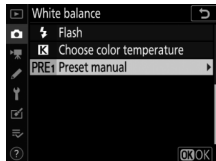

## 2 Select a destination.

- Using the multi selector, highlight the destination preset (d-1 to d-6).
- Press the center of the multi selector to view the preset manual white balance menu.

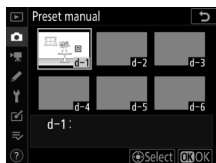

---

### 3 Choose [Select image].

Highlight [**Select image**] and press  to view the pictures on the current memory card.

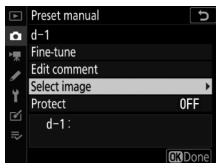

---

### 4 Highlight the source image.

- Highlight the desired image using the multi selector.
- To view the highlighted image full frame, press and hold the  button.



---

### 5 Copy white balance.

- Press  to copy the white balance value for the highlighted photograph to the selected preset.
- If the highlighted photograph has a comment, the comment will be copied to the comment for the selected preset.

---

## ✔ **Fine-Tuning Preset Manual White Balance**

The selected preset can be fine-tuned by selecting [**Fine-tune**] in the preset manual white balance menu.

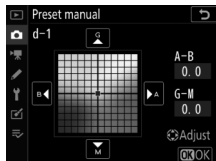

## ✔ **“Edit Comment”**

To enter a descriptive comment of up to 36 characters for the current white-balance preset, select [**Edit comment**] in the preset manual white balance menu. Enter a comment as described in “Text Entry” (86).



## ✔ **“Protect”**

To protect the current white-balance preset, select [**Protect**] in the preset manual white balance menu. Highlight [**On**] and press **OK**; the current white balance preset is now protected. The preset cannot be modified as long as [**On**] is selected for [**Protect**].

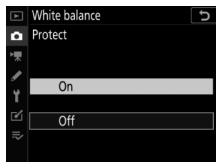

## **Varying Exposure or White Balance over a Series of Photographs (Bracketing)**

Bracketing automatically varies exposure, flash level, Active D-Lighting (ADL), or white balance slightly with each shot, “bracketing” the current value. Choose in situations in which getting the right settings is difficult and there is not time to check results and adjust settings with each shot, or to experiment with different settings for the same subject.

## Bracketing

Bracketing is adjusted using the **[Auto bracketing]** > **[Auto bracketing set]** item in the photo shooting menu, which contains the following options:

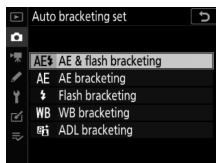

Option	Description
<b>[AE &amp; flash bracketing]</b>	The camera varies exposure and flash level over a series of photographs.
<b>[AE bracketing]</b>	The camera varies exposure over a series of photographs.
<b>[Flash bracketing]</b>	The camera varies flash level over a series of photographs.
<b>[WB bracketing]</b>	The camera creates multiple copies of each photograph, each with a different white balance.
<b>[ADL bracketing]</b>	The camera varies Active D-Lighting (ADL) over a series of exposures.

## **Exposure and Flash Bracketing**

Vary exposure and/or flash level over a series of photographs.  
To perform exposure and/or flash bracketing:



No exposure  
compensation



-1 EV



+1 EV

# 1 Choose the number of shots.

- Hold the **BKT** button and rotate the main command dial to choose the number of shots in the bracketing sequence.

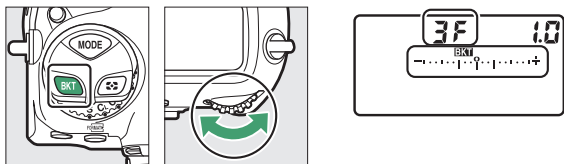

- At settings other than **0F**, a **BKT** icon and an exposure and flash bracketing indicator will appear in the viewfinder and top control panel.

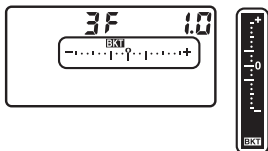



## 2 Select an exposure increment.

- Hold the **BKT** button and rotate the sub-command dial to choose the exposure increment.

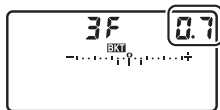
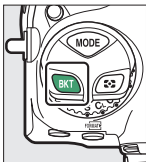

- When **[1/3 step]** is selected for Custom Setting b2 [**EV steps for exposure ctrl**], the size of the increment can be chosen from 0.3 ( $1/3$ ), 0.7 ( $2/3$ ), 1.0, 2.0, and 3.0 EV. Bracketing programs with an increment of 2.0 or 3.0 EV offer a maximum of 5 shots. If a value of 7 or 9 was selected in Step 1, the number of shots will automatically be set to 5.

- The bracketing programs with an increment of 0.3 EV are listed below.

Top control panel	Exposure and flash bracketing indicator	No. of shots	Bracketing order (EVs)
0F 0.3	-.....°.....+	0	0
+ 3F 0.3	-.....ᵀ.....+	3	0/+0.3/+0.7
-- 3F 0.3	-.....ᵀ.....+	3	0/-0.7/-0.3
+ 2F 0.3	-.....ᵀ.....+	2	0/+0.3
-- 2F 0.3	-.....ᵀ.....+	2	0/-0.3
3F 0.3	-.....ᵀ.....+	3	0/-0.3/+0.3
5F 0.3	-.....ᵀ.....+	5	0/-0.7/-0.3/+0.3/+0.7
7F 0.3	-.....ᵀ.....+	7	0/-1.0/-0.7/-0.3/+0.3/+0.7/+1.0
9F 0.3	-.....ᵀ.....+	9	0/-1.3/-1.0/-0.7/-0.3/+0.3/+0.7/+1.0/+1.3

### 3 Take pictures.



- Take the number of pictures in the bracketing program.
- The modified values for shutter speed and aperture are shown in the display.
- Bracketing progress indicators are displayed in the viewfinder and top control panel. A segment indicating the photograph taken will disappear from the indicator after each shot.

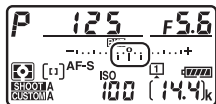

No. shots: 3  
Increment: 0.7

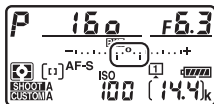

Display after first shot

- Exposure changes due to bracketing are added to those made with exposure compensation.

---

## **Bracketing Options**

When [**AE & flash bracketing**] is selected, the camera varies both exposure and flash level. Select [**AE bracketing**] to vary only exposure, [**Flash bracketing**] to vary only flash level. Note that flash bracketing is available in i-TTL and, where supported, auto aperture (Ⓐ) flash control modes only (☐ 643, 1051).

## **Exposure and Flash Bracketing**

- [**Number of shots**] and [**Increment**] can also be selected via the [**Auto bracketing**] item in the photo shooting menu.
- In **CL** and **CH** modes and during burst photography in mode **Q**, shooting will pause after the number of shots specified in the bracketing program have been taken. Shooting will resume the next time the shutter-release button is pressed.
- If the camera is turned off before all shots in the sequence have been taken, bracketing will resume from the first shot in the sequence when the camera is turned on.

## Exposure Bracketing

The settings (shutter speed and/or aperture) altered during exposure bracketing vary with the exposure mode.

Mode	Setting
<b>P</b>	Shutter speed and aperture <sup>1</sup>
<b>S</b>	Aperture <sup>1</sup>
<b>A</b>	Shutter speed <sup>1</sup>
<b>M</b>	Shutter speed <sup>2,3</sup>

- 1 If **[On]** is selected for **[ISO sensitivity settings] > [Auto ISO sensitivity control]** in the photo shooting menu, the camera will automatically vary ISO sensitivity for optimum exposure when the limits of the camera exposure system are exceeded.
  - 2 If **[On]** is selected for **[ISO sensitivity settings] > [Auto ISO sensitivity control]** in the photo shooting menu, the camera will first use auto ISO sensitivity control to bring exposure as close as possible to the optimum and then bracket this exposure by varying shutter speed.
  - 3 Use Custom Setting e7 **[Auto bracketing (mode M)]** to choose whether the camera varies shutter speed, aperture, or both shutter speed and aperture.
-

## ■ Cancelling Bracketing

To cancel bracketing, press the **BKT** button and rotate the main command dial until the number of shots in the bracketing sequence is zero (0F) and BKT is no longer displayed. The program last in effect will be restored the next time bracketing is activated. Bracketing can also be cancelled by performing a two-button reset (Fn 312), although in this case the bracketing program will not be restored the next time bracketing is activated.

## White Balance Bracketing

The camera creates multiple copies of each photograph, each with a different white balance. To use white balance bracketing:

### 1 Choose the number of shots.

- Hold the **BKT** button and rotate the main command dial to choose the number of shots in the bracketing sequence.

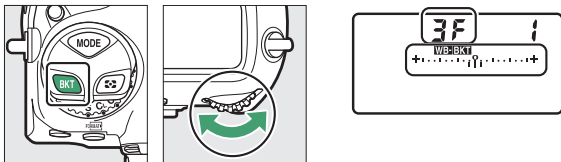

- At settings other than **AF**, a **WB-BKT** icon and a white balance bracketing indicator will appear in the top control panel and **BKT** will be displayed in the viewfinder.

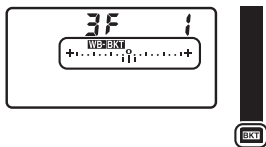

## 2 Select a white balance increment.

- Hold the **BKT** button and rotate the sub-command dial to choose the white balance increment.

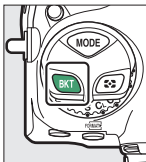

- The size of the increment can be chosen from 1 (1 step), 2 (2 steps), or 3 (3 steps).
- Each step is equivalent to 5 mired. Higher “A” values correspond to increased amounts of amber. Higher “B” values correspond to increased amounts of blue.



- The bracketing programs with an increment of 1 are listed below.

Top control panel	White balance bracketing indicator	No. of shots	White balance increment	Bracketing order
0F	+.....°.....+	0	1	0
b3F	+.....;i.....+	3	1B	0/B1/B2
A3F	+.....;i.....+	3	1A	0/A2/A1
b2F	+.....;i.....+	2	1B	0/B1
A2F	+.....;i.....+	2	1A	0/A1
3F	+.....;ii.....+	3	1A, 1B	0/A1/B1
5F	+.....;iii.....+	5	1A, 1B	0/A2/A1/B1/B2
7F	+.....;iiii.....+	7	1A, 1B	0/A3/A2/A1/B1/B2/B3
9F	+.....;iiiii.....+	9	1A, 1B	0/A4/A3/A2/A1/B1/B2/B3/B4

### 3 Take pictures.

- Each shot will be processed to create the number of copies specified in the bracketing program, and each copy will have a different white balance.
- Modifications to white balance are added to the white balance adjustment made with white balance fine-tuning.
- If the number of shots in the bracketing program is greater than the number of exposures remaining, **FULL** and the icon for the affected memory card will flash in the top control panel, a flashing **FuL** icon will appear in the viewfinder, and the shutter release will be disabled. Shooting can begin when a new memory card is inserted.

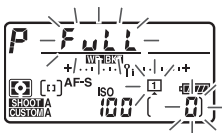

---

## ✓ White Balance Bracketing Restrictions

White balance bracketing is not available at image quality settings of NEF (RAW) or NEF (RAW) + JPEG.

---

## ✍ White Balance Bracketing

- **[Number of shots]** and **[Increment]** can also be selected via the **[Auto bracketing]** item in the photo shooting menu.
  - White balance bracketing affects only color temperature (the amber–blue axis in the white balance fine-tuning display). No adjustments are made on the green–magenta axis.
  - If the camera is turned off while the memory card access lamp is lit, the camera will power off only after all photographs in the sequence have been recorded.
  - In self-timer mode, the number of copies specified in the white balance bracketing program will be created each time the shutter is released, regardless of the option selected for Custom Setting c3 **[Self-timer]** > **[Number of shots]**.
-

## ■ C Cancelling Bracketing

To cancel bracketing, press the **BKT** button and rotate the main command dial until the number of shots in the bracketing sequence is zero (0) and ~~WB-BKT~~ is no longer displayed. The program last in effect will be restored the next time bracketing is activated. Bracketing can also be cancelled by performing a two-button reset (☰ 312), although in this case the bracketing program will not be restored the next time bracketing is activated.

## ADL Bracketing

The camera varies Active D-Lighting (ADL) over a series of exposures. To use ADL bracketing:

### 1 Choose the number of shots.

- Hold the **BKT** button and rotate the main command dial to choose the number of shots in the bracketing sequence.

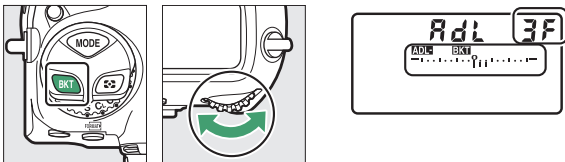

- At settings other than **3F**, an **ADL-BKT** icon and an ADL bracketing indicator will appear in the top control panel and **BKT** will be displayed in the viewfinder.



- The number of shots determines the bracketing sequence:

Number of shots	Bracketing sequence
2	[Off] → Value selected in Step 2
3	[Off] → [Low] → [Normal]
4	[Off] → [Low] → [Normal] → [High]
5	[Off] → [Low] → [Normal] → [High] → [Extra high 1]
	[Low] → [Normal] → [High] → [Extra high 1] → [Extra high 2]

- If you selected 5 shots, you can choose from bracketing sequences of [Off] to [Extra high 1] and [Low] to [Extra high 2] by holding the **BKT** button and rotating the sub-command dial.
- If you chose more than two shots, proceed to Step 3.

---

## 2 Choose the Active D-Lighting amount.

- Hold the **BKT** button and rotate the sub-command dial to choose the Active D-Lighting setting for the second shot when the number of shots in the bracketing sequence is 2.

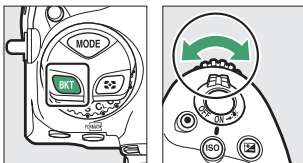

- The selected option is shown in the Active D-Lighting top control panel.

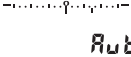
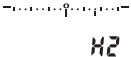
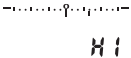
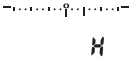
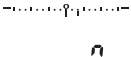
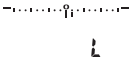
Active D-Lighting amount	Top control panel
☞ A Auto	
☞ H2 Extra high 2	
☞ H1 Extra high 1	
☞ H High	
☞ N Normal	
☞ L Low	



---

### 3 Take pictures.

- Take the number of pictures in the bracketing program.
- While bracketing is in effect, a bracketing progress indicator will be displayed in the top control panel. A segment will disappear from the indicator after each shot.

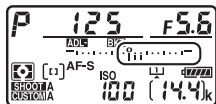

No. shots: 3

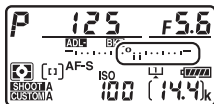

Display after first shot

---

#### ADL Bracketing

- **[Number of shots]** and **[Amount]** can also be selected via the **[Auto bracketing]** item in the photo shooting menu.
  - In **CL** and **CH** modes and during burst photography in mode **Q**, shooting will pause after the number of shots specified in the bracketing program have been taken. Shooting will resume the next time the shutter-release button is pressed.
  - If the camera is turned off before all shots in the sequence have been taken, bracketing will resume from the first shot in the sequence when the camera is turned on.
-



## ■ Cancelling Bracketing







To cancel bracketing, press the **BKT** button and rotate the main command dial until the number of shots in the bracketing sequence is zero (0) and **ADL BKT** is no longer displayed. The program last in effect will be restored the next time bracketing is activated. Bracketing can also be cancelled by performing a two-button reset (☰ 312), although in this case the bracketing program will not be restored the next time bracketing is activated.

# Image Processing (Picture Controls)

## Picture Controls

Adjust image processing (Picture Control) settings according to your subject or creative intent.

	Option	Description
 A	<b>[Auto]</b>	The camera automatically adjusts hues and tones based on the <b>[Standard]</b> Picture Control. <ul style="list-style-type: none"><li>• The complexions of portrait subjects will appear softer than in pictures taken with the <b>[Standard]</b> Picture Control.</li><li>• In outdoor shots, elements such as the foliage and sky will appear more vivid than in pictures taken with the <b>[Standard]</b> Picture Control.</li></ul>
 SD	<b>[Standard]</b>	Standard processing for balanced results. Recommended for most situations.
 NL	<b>[Neutral]</b>	Minimal processing for natural results. Choose for photographs that will later be processed or retouched.

Option		Description
 VI	<b>[Vivid]</b>	Pictures are enhanced for a vivid, photoprint effect. Choose for photographs that emphasize primary colors.
 MC	<b>[Monochrome]</b>	Take monochrome photographs.
 PT	<b>[Portrait]</b>	Smooth complexions for natural-looking portraits.
 LS	<b>[Landscape]</b>	Shoot vibrant landscapes and cityscapes.
 FL	<b>[Flat]</b>	Details are preserved over a wide tone range, from highlights to shadows. Choose for photographs that will later be extensively processed or retouched.
 01- 20	<b>Creative Picture Control</b>	Creative Picture Controls offer unique combinations of hue, tone, saturation, and other settings tuned for particular effects. Choose from a total of 20 options, including <b>[Dream]</b> and <b>[Morning]</b> .

## ■ ■ Choosing a Picture Control

Pressing the **OK** (MENU/?) button displays the Picture Control list. Highlight an option using **◀** or **▶** and press **OK** to select.

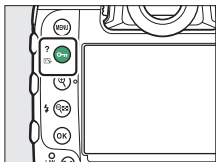

- The Picture Control used for movies can be selected by pressing the **OK** (MENU/?) button during filming.





---

### "Set Picture Control"

The [**Set Picture Control**] item in the movie shooting menu also offers a [**Same as photo settings**] option that sets the Picture Control for movies to the same as that used for photographs.

---

## **Modifying Picture Controls from the Menu**

Picture Controls can be adapted to suit the scene or the photographer's creative intent. Picture Controls can also be edited using the  (  / ? ) button. For more information, see "The  (  / ? ) Button" (  125) in "Camera Controls".

### **1 Select a Picture Control.**

Highlight the desired Picture Control in the Picture Control list and press

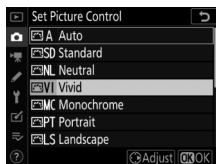

## 2 Adjust settings.

- Press or to highlight settings. Press or to choose a value in increments of 1, or rotate the sub-command dial to choose a value in increments of 0.25.
- The options available vary with the Picture Control selected.
- To quickly adjust levels for balanced [**Sharpening**], [**Mid-range sharpening**], and [**Clarity**], highlight [**Quick sharp**] and press or .
- Default settings can be restored by pressing the (FORMAT) button.



## 3 Save changes and exit.

Press to save changes. Picture Controls that have been modified from default settings are indicated by an asterisk ("\*").



## Custom Picture Controls

Save modified Picture Controls as custom Picture Controls.

Option	Description
[Save/edit]	Create a new custom Picture Control based on an existing preset or custom Picture Control, or edit existing custom Picture Controls.
[Rename]	Rename custom Picture Controls.
[Delete]	Delete custom Picture Controls.
[Load/save]	Copy custom Picture Controls to and from the memory card.

### ■ Creating Custom Picture Controls

- 1 Highlight [Manage Picture Control] in the photo or movie shooting menu and press .**

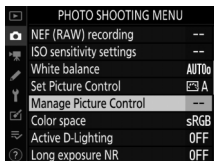



## 2 Select [Save/edit].

Highlight [**Save/edit**] and press **▶** to view [**Choose Picture Control**] options.

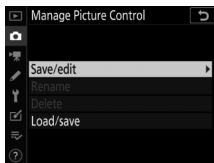

## 3 Select a Picture Control.

- Highlight an existing Picture Control and press **▶**.
- To save a copy of the highlighted Picture Control without further modification, press **ⓄK**. [**Save as**] options will be displayed; proceed to Step 5.

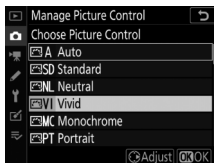

## 4 Adjust settings.

- The options and procedure are the same as for [**Set Picture Control**].
- Press **ⓄK** to display [**Save as**] options when settings are complete.
- Default settings can be restored by pressing the **🗑️ (FORMAT)** button.



## 5 Select a destination.

Choose a destination for the custom Picture Control (C-1 through C-9).

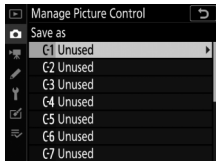

## 6 Name the Picture Control.

- Pressing  when a destination is highlighted in the previous step displays the **[Rename]** text-entry dialog.
- The default name, created by adding a two-digit number to the name of the existing Picture Control, appears in the text display area. The two-digit number is generated automatically by the camera.
- Custom Picture Control names can be up to nineteen characters long.
- For information on text entry, see “Text Entry” (📖 86).



## 7 Press **OK**.

- Text entry will end.
- The new Picture Control will be added to the Picture Control list.

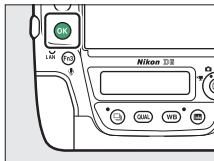

### **The “Original Picture Control” Icon**

The original preset Picture Control on which the custom Picture Control is based is indicated by an icon in the top right corner of the edit display.



## ✔ Custom Picture Control Options

The options available with custom Picture Controls are the same as those on which the custom Picture Control was based.

## ✔ Sharing Custom Picture Controls

The [**Load/save**] item in the [**Manage Picture Control**] menu can be used to copy custom Picture Controls from the camera to a memory card. You can also delete custom Picture Controls or copy them from a memory card to the camera. (The memory card must be inserted in Slot 1. Memory cards inserted in Slot 2 will not be detected.)

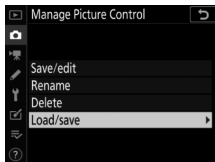

- [**Copy to camera**]: Copy (import) custom Picture Controls from the memory card to the camera. When importing custom Picture Controls, you can choose the destination (C-1 through C-9) and name it as desired.
  - [**Delete from card**]: Delete selected custom Picture Controls from the memory card.
  - [**Copy to card**]: Copy (export) a custom Picture Control from the camera to a memory card. Highlight a destination (1 through 99) for the selected Picture Control and press **ⓧ** to export it to the memory card.
-

## Preserving Detail in Highlights and Shadows (Active D-Lighting and HDR)

### **Active D-Lighting**

Active D-Lighting, accessed via the [Active D-Lighting] item in the photo or movie shooting menu, is used to preserve details in highlights and shadows, creating pictures with natural contrast. Use for high-contrast scenes, for example when photographing brightly-lit outdoor scenery through a door or window or taking pictures of shaded subjects on a sunny day. Active D-Lighting is most effective when [Matrix metering] is selected for metering.









[Off]



[Auto]

## ■ Active D-Lighting Options

Option		Description
 A	[Auto]	The camera automatically adjusts Active D-Lighting in response to shooting conditions.
 H2	[Extra high 2]	Choose the amount of Active D-Lighting performed from [Extra high 2], [Extra high 1], [High], [Normal], and [Low].
 H1	[Extra high 1]	
 H	[High]	
 N	[Normal]	
 L	[Low]	
[Off]		Active D-Lighting off.

### ✓ Active D-Lighting

- “Noise” in the form of randomly-spaced bright pixels, fog, or lines may appear in photos taken with Active D-Lighting.
- In mode **M**, [Auto] is equivalent to [Normal].
- Uneven shading may be visible with some subjects.
- Active D-Lighting does not apply at high ISO sensitivities (Hi 0.3–Hi 5), including high sensitivities selected via auto ISO sensitivity control.
- The [Active D-Lighting] option in the movie shooting menu offers a choice of [Extra high], [High], [Normal], [Low], and [Off].

## High Dynamic Range (HDR)

The [HDR (high dynamic range)] item in the photo shooting menu can be used with high-contrast subjects to preserve details in highlights and shadows by combining two shots taken at different exposures. Use with high-contrast scenes and other subjects to preserve a wide range of details, from highlights to shadows.



## ■ HDR Options

Option	Description
[HDR mode]	<ul style="list-style-type: none"><li>• <b>[On (series)]</b>: Take a series of HDR photographs. To end HDR photography, select <b>[HDR mode]</b> again and choose <b>[Off]</b>.</li><li>• <b>[On (single photo)]</b>: Take a single HDR photograph.</li><li>• <b>[Off]</b>: End HDR photography.</li></ul>
[Exposure differential]	Choose the difference in exposure between the two shots. The higher the value, the greater the dynamic range. If <b>[Auto]</b> is selected, the camera will automatically adjust the exposure differential to suit the scene.
[Smoothing]	Choose how much the boundaries between the two images are smoothed.
[Save individual images (NEF)]	Choose <b>[On]</b> to save each of the individual shots used to create the HDR image; the shots are saved in NEF (RAW) format. The shots are saved at an image size of <b>[Large]</b> , regardless of the option selected for <b>[Image size]</b> > <b>[NEF (RAW)]</b> in the photo shooting menu.





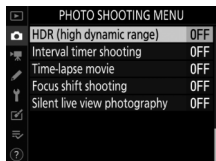

## ■ Taking HDR Photographs

We recommend that you use the [**Matrix metering**] metering option when shooting with HDR.

- 1 Highlight [HDR (high dynamic range)] in the photo shooting menu and press .**



- 2 Select an [HDR mode].**

- Highlight [**HDR mode**] and press .
- Highlight one of the following options using  or  and press .

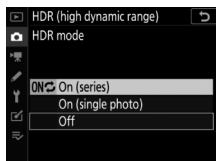
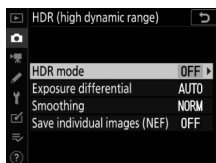



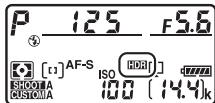

Option	Description
[ON  On (series)]	Take a series of HDR photographs. HDR shooting will continue until you select [Off] for [HDR mode].
[On (single photo)]	Normal shooting will resume after you have taken a single HDR photograph.
[Off]	Proceed without taking additional HDR photographs.

- If [On (series)] or [On (single photo)] is selected, an HDR icon will be displayed in the top control panel while HDR mode is in effect.





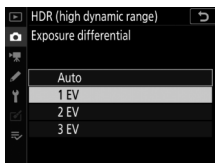
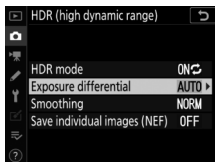

### 3 Choose a value for [Exposure differential].

- Highlight [**Exposure differential**] and press .
- Highlight an option using  or  and press .
- Choose higher values for high-contrast subjects.
- Note, however, that choosing a higher value than required may not produce the desired results. Match your choice to the level of contrast in the scene.
- If [**Auto**] is selected, the camera will automatically adjust the exposure differential to suit the scene.





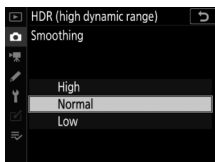
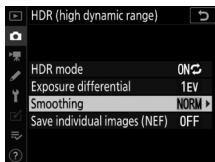

## 4 Adjust [Smoothing].

- Highlight [**Smoothing**] and press .
- Highlight an option using  or  and press ; the selected option represents the amount the boundaries between the two images are smoothed.
- Higher values produce a smoother composite image.



## 5 Choose a setting for [Save individual images (NEF)].

- Highlight [**Save individual images (NEF)**] and press .
- Highlight an option using  or  and press .
- Choose [**On**] to save each of the individual shots used to create the HDR image; the shots are saved in NEF (RAW) format. The shots are saved at an image size of [**Large**], regardless of the option selected for [**Image size**] > [**NEF (RAW)**] in the photo shooting menu.

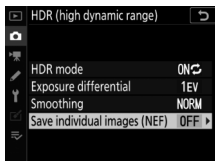

## 6 Frame the photograph, focus, and shoot.

- The camera takes two exposures when the shutter-release button is pressed all the way down.
- Flashing “b53” and “53” indicators appear respectively in the top control panel and viewfinder while the images are combined. No additional pictures can be taken until recording is complete.

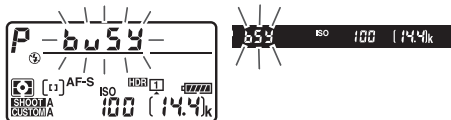

- If [On (series)] is selected for [HDR mode], you can continue to take HDR photographs until [Off] is selected.
- If [On (single photo)] is selected, HDR will turn off automatically after a single shot.

---

## ✓ NEF (RAW)

HDR photographs taken when an NEF (RAW) or NEF (RAW) + JPEG option is selected for image quality will be recorded in JPEG format.

## ✓ HDR Photography

- The edges of the image will be cropped out.
- The desired results may not be achieved if the camera or subject moves during shooting. Use of a tripod is recommended.
- Depending on the scene, you may notice shadows around bright objects or halos around dark objects. This can be mitigated using **[Smoothing]**.
- Uneven shading may be visible with some subjects.
- With non-CPU lenses and when **[Spot metering]** or **[Center-weighted metering]** is selected, an **[Exposure differential]** of **[Auto]** is equivalent to **[2 EV]**.
- Optional flash units will not fire.
- In **CL** and **CH** modes and during burst photography in mode **Q**, only one photograph will be taken each time the shutter-release button is pressed all the way down.
- Shutter speeds of **b** **u** **1** **b** ("Bulb") and - - ("Time") are not available.

## ✓ HDR Restrictions

HDR cannot be combined with some camera features, including:

- Bracketing
- Multiple exposure
- Interval-timer photography
- Time-lapse movies
- Focus shift

---

## ✓ Adjusting HDR Settings

When [**HDR (high dynamic range)**] is selected for Custom Setting f3 [**Custom controls**] > [**BKT button**], [**HDR mode**] (Step 2) and [**Exposure differential**] (Step 3) can be selected using the **BKT** button and command dials.

- Hold the **BKT** button and rotate the main command dial to choose from the following HDR modes: **OFF** ([**Off**]), **i** ([**On (single photo)**]), and **L** ([**On (series)**]).
- You can choose the exposure differential by holding the **BKT** button and rotating the sub-command dial.



# Movie Recording and Editing

## Image Area: Choosing a Movie Crop

At frame sizes of  $1920 \times 1080$  and  $1280 \times 720$ , you can choose an image area using the **[Image area]** > **[Choose image area]** option in the movie shooting menu. Select **[FX]** to shoot movies in what is referred to as “FX-based movie format”, **[DX]** to shoot in “DX-based movie format”. The differences between the two are illustrated below.





- The sizes of the areas recorded in FX- and DX-based movie formats differ. The differences are shown below.





Format	Area recorded
<b>FX-based movie format</b>	Approx. $35.9 \times 20.2$ mm
<b>DX-based movie format</b>	Approx. $23.5 \times 13.2$ mm



- Movies shot with a DX-format lens and **[On]** selected for **[Image area]** > **[Auto DX crop]** in the movie shooting menu are recorded in DX-based movie format.
- Image-area selection is not available at frame sizes of  $3840 \times 2160$  and “ $1920 \times 1080$  crop”. Image area does not change when a DX lens is attached.
- Enabling electronic vibration reduction by selecting **[On]** for **[Electronic VR]** in the movie shooting menu reduces the size of the crop, slightly increasing the apparent focal length.

## Frame Size/Frame Rate and Movie Quality

The [**Frame size/frame rate**] item in the movie shooting menu is used to choose the movie frame size (in pixels) and frame rate. You can also choose from two [**Movie quality**] options: [**High quality**] and [**Normal**]. Together, these options determine the maximum bit rate and recording time, as shown in the following table.

Frame size/frame rate <sup>1</sup>		Max. bit rate		Max. recording time
		High quality	Normal	
$\frac{2160}{60} \frac{P}{F}$	[3840 × 2160; 30p] <sup>2</sup>	144 Mbps	— <sup>3</sup>	29 min. 59 s <sup>4</sup>
$\frac{2160}{50} \frac{P}{F}$	[3840 × 2160; 25p] <sup>2</sup>			
$\frac{2160}{24} \frac{P}{F}$	[3840 × 2160; 24p] <sup>2</sup>			
$\frac{1080}{60} \frac{P}{F} / \frac{1080}{60} \frac{P}{F}$	[1920 × 1080; 60p]	56 Mbps	28 Mbps	29 min. 59 s <sup>4</sup>
$\frac{1080}{50} \frac{P}{F} / \frac{1080}{50} \frac{P}{F}$	[1920 × 1080; 50p]			
$\frac{1080}{60} \frac{P}{F} / \frac{1080}{60} \frac{P}{F}$	[1920 × 1080; 30p]	28 Mbps	14 Mbps	
$\frac{1080}{24} \frac{P}{F} / \frac{1080}{24} \frac{P}{F}$	[1920 × 1080; 25p]			
$\frac{1080}{60} \frac{P}{F} / \frac{1080}{60} \frac{P}{F}$	[1920 × 1080; 24p]			
$\frac{720}{60} \frac{P}{F} / \frac{720}{60} \frac{P}{F}$	[1280 × 720; 60p]			
$\frac{720}{50} \frac{P}{F} / \frac{720}{50} \frac{P}{F}$	[1280 × 720; 50p]			

Frame size/frame rate <sup>1</sup>		Max. bit rate		Max. recording time
		High quality	Normal	
 [1920×1080; 60p crop] <sup>5</sup>	56 Mbps	28 Mbps	29 min. 59 s <sup>4</sup>	
 [1920×1080; 50p crop] <sup>5</sup>				
 [1920×1080; 30p crop] <sup>5</sup>	28 Mbps	14 Mbps		
 [1920×1080; 25p crop] <sup>5</sup>				
 [1920×1080; 24p crop] <sup>5</sup>				

- 1 The frame rates for 60p, 50p, 30p, 25p, and 24p are respectively 59.94 fps, 50 fps, 29.97 fps, 25 fps, and 23.976 fps.
- 2 Movies are recorded in 4K UHD.  is displayed in the monitor.
- 3 Movie quality fixed at [**High quality**].
- 4 Each movie may be recorded across up to 8 files. Each file may be up to 4 GB in size. The number of files and the length of each file vary with the options selected for [**Movie quality**] in the movie shooting menu. Movies recorded to memory cards formatted in the camera will however be recorded as a single file regardless of size if the card has a capacity over 32 GB.
- 5  is displayed in the monitor.

## The Movie Crop

Movies have an aspect ratio of 16:9. The crop varies with frame size.

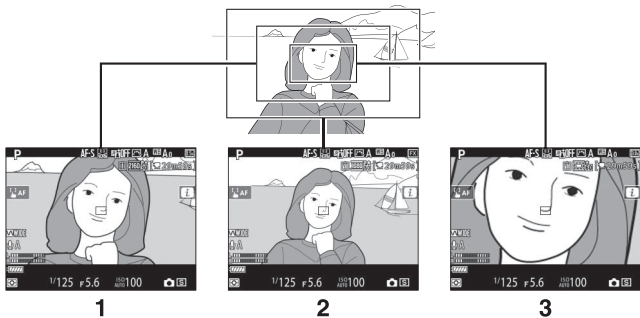

**1** 3840 × 2160

**2** 1920 × 1080 and 1280 × 720

**3** 1920 × 1080 crop

- Going from a frame size of 1920 × 1080 or 1280 × 720 to 3840 × 2160 increases the apparent focal length by approximately 1.5x.
- Going from 1920 × 1080 or 1280 × 720 to “1920 × 1080 crop” increases the apparent focal length by approximately 3x.

## Points to Note When Recording Movies

Note the following points when recording movies:

- Depending on memory card write speed, shooting may end before the maximum length (📖 294) is reached.
- Note that the number of subjects that can be detected in **[Face-priority AF]** drops during movie recording.
- A  icon (📖 17) indicates that movies cannot be recorded.
- **[Spot metering]** is not available during movie recording.
- Flash lighting (📖 641) cannot be used.

## ✔ **Movie Recording: Exposure Mode**

- If the subject is over- or under-exposed in mode **P** or **S**, exit and restart live view or select mode **A** and adjust aperture.
- The following exposure settings can be adjusted during filming:

Mode	Aperture	Shutter speed	ISO sensitivity <sup>2</sup>
<b>P, S</b> <sup>1</sup>	—	—	— <sup>3</sup>
<b>A</b>	✓	—	— <sup>3</sup>
<b>M</b>	✓	✓	✓ <sup>4</sup>

- 1 Exposure control in mode **S** is the same as in mode **P**.
- 2 If **[On]** is selected for **[Electronic VR]** in the movie shooting menu when ISO sensitivity is set to a value of from Hi 0.3 to Hi 5, ISO sensitivity will be limited to 102400.
- 3 The upper limit for ISO sensitivity can be selected using the **[ISO sensitivity settings] > [Maximum sensitivity]** item in the movie shooting menu.
- 4 If **[On]** is selected for **[ISO sensitivity settings] > [Auto ISO control (mode M)]** in the movie shooting menu, the upper limit for ISO sensitivity can be selected using **[Maximum sensitivity]**.

## ✔ **Adjusting White Balance During Movie Recording**

White balance can be adjusted during movie recording by holding the **WB** button and rotating the main command dial. If **[Auto]** or **[Fluorescent]** is selected, a sub-option can be selected by rotating the sub-command dial.

### **Recording Movies in Mode M**

In mode **M** shutter speed can be set to values between  $1/25$  s and  $1/8000$  s (the slowest available shutter speed varies with the frame rate).

### **Wireless Remote Controllers and Remote Cords**

If **[Record movies]** is selected for Custom Setting g2 **[Custom controls]** > **[Shutter-release button]**, the shutter-release buttons on optional wireless remote controllers and remote cords can be pressed halfway to start live view or pressed all the way down to start and end movie recording.





### **Using an External Microphone**

Optional ME-1 stereo microphones or ME-W1 wireless microphones can be used to record movie audio.

---

## Editing Movies

Movies can be edited using the following options:

	Option	Description
	<b>[Choose start/end point]</b>	Create a copy from which unwanted footage has been removed.
	<b>[Save current frame]</b>	Save a selected frame as a JPEG still.
	<b>[Add index]</b>	Add indices to movies during playback. Indices can be used to quickly locate frames during playback and editing (📖 307).
	<b>[Delete index]</b>	Delete indices from movies (📖 307).





# Trimming Movies



## 1 Display a movie full frame.

## 2 Pause the movie on the new opening frame.

- Press the center of the multi selector to start playback. Press  to pause.
- Your approximate position in the movie can be ascertained from the movie progress bar.
- Press  or  or rotate the main command dial to locate the desired frame.



## 3 Select [Choose start/end point].

Press the **i** button, highlight [Choose start/end point], and press .



## 4 Choose the start point.

To create a copy that begins from the current frame, highlight **[Start point]** and press **OK**.

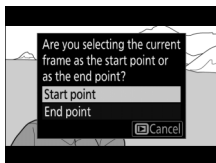

## 5 Confirm the new start point.

- If the desired frame is not currently displayed, press **⏪** or **⏩** to advance or rewind.
- To skip to 10 s ahead or back, rotate the main command dial.
- To skip to the first or last frame, rotate the sub-command dial.



## 6 Choose the end point.

Press **OK** (⏏/? ) to switch to the end-point selection tool (▮) and then select the closing frame (▮) as described in Step 5.

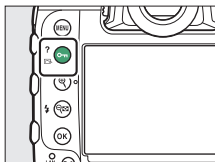

## 7 Press **OK** to create the copy.

## 8 Preview the copy.

- To preview the copy, highlight [**Preview**] and press **OK** (to interrupt the preview and return to the save options menu, press **OK**).
- To abandon the current copy and return to Step 5, highlight [**Cancel**] and press **OK**.

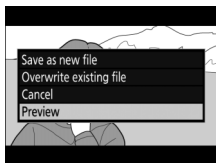

---

## 9 Choose a save option.

Choose [**Save as new file**] to save the edited copy as a new file. To replace the original movie with the edited copy, choose [**Overwrite existing file**].

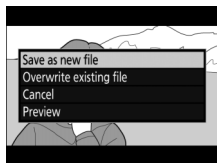

---

## 10 Save the copy.

Press **OK** to save the copy.





---

### ✔ Trimming Movies

- The copy will not be saved if there is insufficient space available on the memory card.
  - Movies less than two seconds long cannot be edited using [**Choose start/end point**].
  - Copies have the same time and date of creation as the original.
-

---

### **Removing Opening or Closing Footage**

- To remove only the closing footage from a movie, choose **[End point]** in Step 4, select the closing frame, and proceed to Step 7 without pressing the  (/?) button in Step 6.
- To remove only the opening footage, proceed to Step 7 without pressing the  (/?) button in Step 6.



### **The Retouch Menu [Trim Movie] Option**

Movies can also be edited using the **[Trim movie]** item in the retouch menu.

---



## Saving Selected Frames as JPEG Stills

### 1 Pause the movie on the desired frame.

- Press  to pause playback.
- Press  or  to locate the desired frame.



### 2 Choose [Save current frame].

Press the  button, then highlight [Save current frame] and press  to create a JPEG copy of the current frame.





#### [Save Current Frame]

- Stills are saved at the dimensions selected for [Frame size/frame rate] in the movie shooting menu when the movie was recorded.
- They cannot be retouched.
- Some categories of photo information are not displayed during playback.

## Adding Indices to Movies



---

### 1 Pause playback on the desired frame.

- Press  to pause playback.
- Press  or  to locate the desired frame.



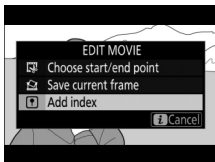

### 2 Select [Add index].

- Press the  button, highlight [Add index], and press  to add an index.
- Up to 20 indices can be added to each movie.



---

### Deleting Indices



After rotating the sub-command dial to skip to the desired index (either while playback is in progress or while playback is paused), press the  button to display a menu. The selected index can then be deleted by highlighting [Delete index] and pressing .

---



# Other Shooting Options

## Using Two Memory Cards

To choose the role played by the memory card in Slot 2 when two memory cards are inserted, select **[Role played by card in Slot 2]** in the photo shooting menu.

Option		Description
	<b>[Overflow]</b>	The card in Slot 2 is used only when the card in Slot 1 is full.
	<b>[Backup]</b>	Each picture is recorded twice, once to the card in Slot 1 and again to the card in Slot 2.
	<b>[RAW Slot 1 - JPEG Slot 2]</b>	<ul style="list-style-type: none"><li>• NEF (RAW) copies of photos taken at settings of NEF (RAW) + JPEG are recorded only to the card in Slot 1, JPEG copies only to the card in Slot 2.</li><li>• Pictures taken at other image quality settings are recorded twice at the same setting, once to the card in Slot 1 and again to the card in Slot 2.</li></ul>

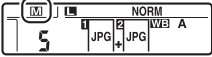

Option	Description
 <p data-bbox="192 339 346 397"><b>[JPEG Slot 1 - JPEG Slot 2]</b></p>	<ul style="list-style-type: none"> <li>• Two JPEG copies are recorded, one to each memory card.</li> <li>• The copy saved to the card in Slot 1 is recorded at the image quality and size selected via the <b>QUAL</b> button or photo shooting menu. The copy saved to the card in Slot 2 is recorded at an image quality of <b>[JPEG basic]</b> and a size of either <b>[Medium]</b> or <b>[Small]</b>. The size can be selected by pressing  when <b>[JPEG Slot 1 - JPEG Slot 2]</b> is highlighted.</li> <li>• At image qualities of NEF (RAW) or NEF (RAW) + JPEG, this option is equivalent to <b>[Backup]</b>.</li> <li>• The size of the images recorded to the card in Slot 2 is displayed in the rear control panel.</li> </ul> 

### **[RAW Slot 1 - JPEG Slot 2]**

If **[On]** is selected for **[Multiple exposure]** > **[Save individual images (NEF)]** in the photo shooting menu, or if **[On]** is selected for **[HDR (high dynamic range)]** > **[Save individual images (NEF)]** in the photo shooting menu, unprocessed copies of the individual NEF (RAW) photos that make up each multiple exposure or HDR image will be recorded to both memory cards together with the JPEG composite, regardless of the option selected for image quality.

---

### ✔ [Backup], [RAW Slot 1 - JPEG Slot 2], and [JPEG Slot 1 - JPEG Slot 2]

- The viewfinder and top control panel show the number of exposures remaining on the card with the least amount of space available.
- The shutter release is disabled when either card is full.

### ✔ Viewing Dual-Format Photos

- Use the [Dual-format recording PB slot] item in the playback menu to choose the slot from which dual-format photos are played back.
- When viewing dual-format photos, you can view the other copy using [Jump to copy on other card] in the **i** menu.





### ✔ Recording Movies

When two memory cards are inserted in the camera, the slot used to record movies can be selected using the [Destination] item in the movie shooting menu.

---

## Deleting Copies

When deleting pictures recorded using **[Backup]**, **[RAW Slot 1 - JPEG Slot 2]**, or **[JPEG Slot 1 - JPEG Slot 2]**, you have the choice of erasing either both copies or only the copy on the card in the current slot.

- Pressing  (FORMAT) when a picture created using either of these options is highlighted during playback displays a confirmation message.
- To delete only the copy on the card in the current slot, highlight **[Selected image]** and press  (FORMAT) again.
- To delete both copies, highlight **[Same images on [1] and [2]]** and press  (FORMAT).
- If a voice memo is appended to the picture, a confirmation dialog will be displayed. To delete only the voice memo, highlight **[Voice memo only]** and press  (FORMAT).

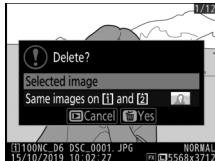

---

### Delete Options

Use the **[Delete images from both slots]** item in the playback menu to choose the options displayed when a picture is deleted.

---

## Two-Button Reset: Restoring Default Settings

The camera settings listed below can be restored to default values by pressing the two buttons marked with green dots (🖥️ and **WB**) at the same time and holding them for over two seconds (the control panels turn off briefly while settings are reset).

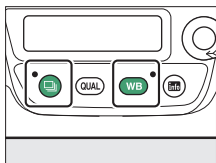

## **Photo Shooting Menu**

With the exceptions of multiple exposure, interval timer, time-lapse movie, and focus shift, only settings in the current photo shooting menu bank are affected.

<b>Option</b>	<b>Default</b>
Extended photo menu banks	Off
Image quality	JPEG normal
Image size	
JPEG	Large
NEF (RAW)	Large
ISO sensitivity settings	
ISO sensitivity	100
Auto ISO sensitivity control	Off
White balance	AUTO0 Keep white (reduce warm colors)
Fine-tune	A-B: 0, G-M: 0
Set Picture Control	Auto
Active D-Lighting	Off

Option	Default
Flicker reduction	
Flicker reduction setting	Disable
Flicker reduction indicator	On
Auto bracketing	Off <sup>1</sup>
Multiple exposure	Off <sup>2</sup>
HDR (high dynamic range)	Off <sup>3</sup>
Silent live view photography	Off

- 1 The number of shots is reset to zero. The bracketing increment for exposure, flash, and white balance bracketing is reset to 1. The amount for the second shot in two-shot ADL bracketing programs is reset to **[Auto]**.
- 2 If a multiple exposure is currently in progress, shooting will end and a multiple exposure will be created from exposures recorded to that point. If **[On (series)]** or **[On (single photo)]** is selected, the multiple exposure mode will be reset to **[Off]**. **[Number of shots]**, **[Overlay mode]**, **[Save individual images (NEF)]** and **[Overlay shooting]** are not reset.
- 3 **[On (series)]** and **[On (single photo)]** are reset to **[Off]**. **[Exposure differential]**, **[Smoothing]**, and **[Save individual images (NEF)]** are not reset.

## **Movie Shooting Menu**

<b>Option</b>	<b>Default</b>
ISO sensitivity settings	
Maximum sensitivity	102400
Auto ISO control (mode M)	Off
ISO sensitivity (mode M)	100
White balance	Same as photo settings
Set Picture Control	Same as photo settings
Active D-Lighting	Off
Electronic VR	Off
Headphone volume	15

## **Other Settings**

<b>Option</b>	<b>Default</b>
Focus point	Center
Preset focus point	Center
Exposure mode	Programmed auto
Flexible program	Off
Exposure compensation	Off (0.0)
AE lock (Hold)	Off
Aperture lock	Off
Shutter speed lock	Off
Exposure preview	Off
Autofocus mode	AF-S
AF-area mode (viewfinder photography)	Single-point AF



<b>Option</b>	<b>Default</b>
AF-area mode (live view/filming)	Normal-area AF
Photo live view display WB	None
Metering	Matrix metering
Flash mode	Fill flash
Flash compensation	Off (0.0)
FV lock	Off
Multi-selector power aperture	Disable
Multi selector exposure comp.	Disable
Exposure delay mode	Off *
Highlight display	Off

\* Only settings in the current Custom Settings menu bank are affected.

## Combining Multiple Exposures in a Single Photo (Multiple Exposure)

Use the [**Multiple exposure**] item in the photo shooting menu to record two to ten NEF (RAW) exposures as a single photograph.

### Multiple Exposure Options

Option	Description
[ <b>Multiple exposure mode</b> ]	<ul style="list-style-type: none"><li>• [<b>On (series)</b>]: Take a series of multiple exposures. To end multiple exposure photography, select [<b>Multiple exposure mode</b>] again and choose [<b>Off</b>].</li><li>• [<b>On (single photo)</b>]: Create one multiple exposure.</li><li>• [<b>Off</b>]: End multiple exposure photography.</li></ul>
[ <b>Number of shots</b> ]	Choose the number of exposures that will be combined to form a single photograph.

Option	Description
<p>[Overlay mode]</p>	<ul style="list-style-type: none"> <li>• <b>[Add]:</b> The exposures are overlaid without modification; gain is not adjusted.</li> <li>• <b>[Average]:</b> Gain is adjusted before the exposures are overlaid.               <ul style="list-style-type: none"> <li>- The gain for each exposure is equal to 1 divided by the total number of exposures taken. For example, in a photo made by combining two exposures, the gain for each exposure will be set to <math>1/2</math>, while in a photo combining three exposures, gain will be set to <math>1/3</math>.</li> </ul> </li> <li>• <b>[Lighten]:</b> The camera compares the pixels in each exposure and uses only the brightest.</li> </ul>
	<ul style="list-style-type: none"> <li>• <b>[Darken]:</b> The camera compares the pixels in each exposure and uses only the darkest.</li> </ul>





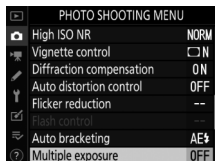

Option	Description
<p><b>[Save individual images (NEF)]</b></p>	<ul style="list-style-type: none"> <li>• <b>[On]:</b> Save both the multiple exposure and the shots that make it up; the latter are saved in NEF (RAW) format.</li> <li>• <b>[Off]:</b> Discard the individual shots and save only the multiple exposure.</li> </ul>
<p><b>[Overlay shooting]</b></p>	<ul style="list-style-type: none"> <li>• <b>[On]:</b> Earlier exposures are superimposed on the view through the lens during live view photography. The earlier exposures aid composition of the next shot.</li> <li>• <b>[Off]:</b> Earlier exposures are not displayed while shooting is in progress.</li> </ul>
<p><b>[Select first exposure (NEF)]</b></p>	<p>Choose the first exposure from the NEF (RAW) images on the memory card.</p>

# Creating a Multiple Exposure

- 1 Highlight [Multiple exposure] in the photo shooting menu and press .





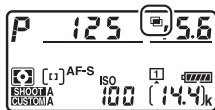
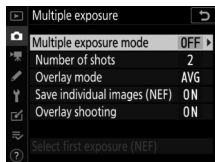

- 2 Choose an option for [Multiple exposure mode].

- Highlight [Multiple exposure mode] and press .
- Highlight a multiple exposure mode using  or  and press .
- A  icon is displayed in the top control panel when [On (series)] or [On (single photo)] is selected.





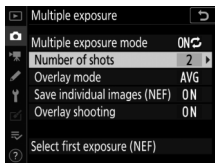

### 3 Choose a value for [Number of shots] (number of exposures).

- Highlight [Number of shots] and press .
- Choose the number of exposures using  or  and press .





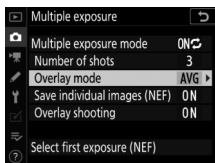

### 4 Choose an option for [Overlay mode].

- Highlight [Overlay mode] and press .
- Highlight an option using  or  and press .



---



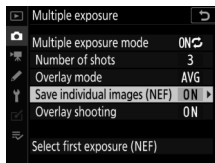

## 5 Choose a setting for [Save individual images (NEF)].

- Highlight [**Save individual images (NEF)**] and press .
- Highlight an option using  or  and press .
- To save both the multiple exposure and the shots that make it up, select [**On**]; the individual shots are saved in NEF (RAW) format. To save only the multiple exposure, select [**Off**].





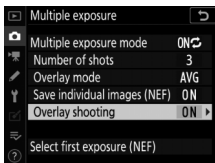

---

## 6 Choose an option for [Overlay shooting].

- Highlight [**Overlay shooting**] and press .
- Highlight an option using  or  and press .
- Select [**On**] to superimpose earlier exposures on the view through the lens in live view.



## 7 Choose an option for [Select first exposure (NEF)].

- To choose the first exposure from existing NEF (RAW) photos, highlight [Select first exposure (NEF)] and press .
- Use the multi selector to highlight the desired picture.
- To view the highlighted picture full frame, press and hold the  button.
- To view pictures in other locations, press  and choose the desired card and folder in the [Choose slot and folder] dialog.
- After highlighting the desired picture, press .
- If an NEF (RAW) image taken at an ISO sensitivity of Hi 0.3 to Hi 5 is selected as the first exposure, the electronic shutter will not be used to record the remaining shots even if [Enable] is selected for Custom Setting d6 [Electronic front-curtain shutter].

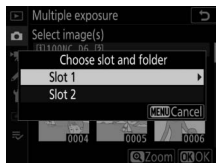



## 8 Start shooting.



- The  icon will flash.
- Take the selected number of shots. If you used [**Select first exposure (NEF)**] to select an existing NEF (RAW) image as the first exposure in Step 7, shooting will start from the second exposure.

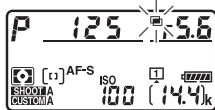

- The number of exposures remaining in the current multiple exposure can be displayed by pressing the shutter-release button halfway between shots.

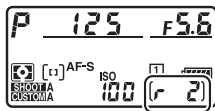

- Once you have taken the selected number of shots, the pictures will be overlaid to create a multiple exposure. Multiple exposures are recorded in JPEG format regardless of the option selected for image quality.

- If [**On (single photo)**] is selected, the camera will exit multiple exposure mode and the  icon will clear from the display once the number of shots selected in Step 3 has been taken and the multiple exposure has been recorded.
- If [**On (series)**] is selected for [**Multiple exposure mode**], you can continue to take additional multiple exposures until [**Off**] is selected.

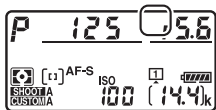

---

### ✔ Multiple Exposure

- Voice memos can be recorded once shooting is complete. You cannot record voice memos while shooting is in progress.
- If you use the monitor for menu navigation or playback while shooting a multiple exposure, remember that shooting will end and the multiple exposure will be recorded if no operations are performed for about 30 seconds after the monitor has turned off. The time available to record the next exposure can be extended by choosing longer times for Custom Setting c2 [**Standby timer**].

- Multiple exposures may be affected by “noise” in the form of randomly-spaced bright pixels, fog, or lines.
  - In **CL** and **CH** modes and during silent burst photography in mode **Q**, the camera will take pictures while the shutter-release button is pressed and record a multiple exposure once the selected number shots has been taken. If [**On (single photo)**] is selected for multiple exposure mode, multiple exposure mode will end once a multiple exposure has been recorded. If [**On (series)**] is selected, the camera will continue to record multiple exposures while the shutter-release button is pressed.
  - In self-timer mode (☐ 209), the interval between each shot in the exposure is selected using Custom Setting c3 [**Self-timer**] > [**Interval between shots**]. Regardless of the value selected for the c3 [**Number of shots**] option, shooting will however end after the number of shots selected for the multiple exposure.
  - Shooting settings and photo info for multiple exposure photographs are those for the first exposure.
  - Do not remove or replace the memory card while a multiple exposure is in progress.
  - Memory cards cannot be formatted while a multiple exposure is in progress. Some menu items will be grayed out and unavailable.
-

---

## ✓ Adjusting Multiple Exposure Settings

When [Multiple exposure] is selected for Custom Setting f3 [Custom controls] > [BKT button], [Multiple exposure mode] (Step 2) and [Number of shots] (Step 3) can be selected using the **BKT** button and command dials.

- Hold the **BKT** button and rotate the main command dial to choose from the following multiple exposure modes: **OFF** ([Off]), **i** ([On (single photo)]), and **L** ([On (series)]).



- You can choose the number of shots by holding the **BKT** button and rotating the sub-command dial until the desired value is displayed in the top control panel.

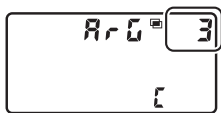



## ✓ Multiple Exposure: Restrictions

Multiple exposure cannot be combined with some camera features, including:

- Movie recording
- Bracketing
- HDR (high dynamic range)
- Interval-timer photography
- Time-lapse movies
- Focus shift

## Using the **i** Button

Pictures can be viewed by pressing the  button while a multiple exposure is in progress. The most recent shot in the current multiple exposure is indicated by a  icon; pressing the **i** button when this icon is present displays the multiple exposure **i** menu.

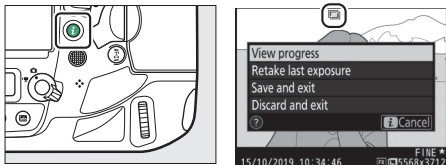

- Highlight items and press **OK** to select.
- You can also have the option of using touch controls after pressing the **i** button.

Option	Description
[View progress]	View a preview created from the exposures recorded to the current point.
[Retake last exposure]	Retake the most recent exposure.
[Save and exit]	Create a multiple exposure from the exposures taken to current point.
[Discard and exit]	Exit without recording a multiple exposure. <ul style="list-style-type: none"><li>• If <b>[On]</b> is selected for <b>[Save individual images (NEF)]</b>, the individual exposures will be saved separately.</li></ul>

## Ending Multiple Exposures

To end a multiple exposure before the specified number of exposures have been taken, select **[Off]** for multiple exposure mode. A multiple exposure will be created from the exposures that have been recorded to that point (if **[Average]** is selected for **[Overlay mode]**, gain will be adjusted to reflect the number of exposures actually recorded).

The multiple exposure will also end if:

- a two-button reset is performed,
- the camera is turned off,
- the battery is exhausted, or
- you press the **[▶]** button followed by the **[i]** button and select either **[Save and exit]** or **[Discard and exit]**

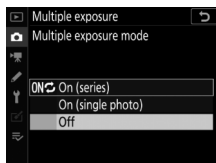

## Taking Photos at a Set Interval (Interval Timer Shooting)

Use the [**Interval timer shooting**] item in the photo shooting menu to take photographs at a selected interval until a specified number of shots has been recorded. When using the interval timer, select a release mode other than  and **MUP**.

### Interval Timer Shooting Options





Option	Description
[ <b>Start</b> ]	Start interval timer shooting. Shooting will begin either after 3 s ([ <b>Now</b> ] selected for [ <b>Choose start day/time</b> ]) or at a selected date and time [ <b>Choose day/time</b> ]. Shooting will continue at the selected interval until all shots have been taken.
[ <b>Choose start day/time</b> ]	Choose a start option. Select [ <b>Now</b> ] to start shooting immediately, [ <b>Choose day/time</b> ] to start shooting at a chosen date and time.
[ <b>Interval</b> ]	Specify the interval between shots in hours, minutes, and seconds.
[ <b>Intervalsxshots/interval</b> ]	Choose the number of intervals and the number of shots per interval.

Option	Description
<p><b>[Exposure smoothing]</b></p>	<p>Selecting <b>[On]</b> allows the camera to adjust exposure to match the previous shot.</p> <ul style="list-style-type: none"> <li>• Large changes in subject brightness during shooting may result in apparent variations in exposure. This can be addressed by shortening the interval between shots.</li> <li>• Exposure smoothing will not take effect in mode <b>M</b> if <b>[Off]</b> is selected for <b>[ISO sensitivity settings]</b> &gt; <b>[Auto ISO sensitivity control]</b> in the photo shooting menu.</li> </ul>
<p><b>[Silent photography]</b></p>	<p>Select <b>[On]</b> to silence the shutter and eliminate the vibrations it produces during shooting.</p>



Option	Description
<b>[Interval priority]</b>	<ul style="list-style-type: none"> <li>• <b>[On]</b>: Enable interval priority to ensure that frames shot in modes <b>P</b> and <b>A</b> are taken at the chosen interval. <ul style="list-style-type: none"> <li>- Flash photography is disabled.</li> <li>- The number of shots per interval is set to 1, even if the number of shots chosen for <b>[Intervalsxshots/interval]</b> is 2 or more.</li> <li>- If <b>AF-S</b> is selected for autofocus mode, select <b>[Release]</b> for Custom Setting a2 <b>[AF-S priority selection]</b>. If <b>AF-C</b> is selected, select <b>[Release]</b> for Custom Setting a1 <b>[AF-C priority selection]</b>.</li> <li>- If <b>[On]</b> is selected for <b>[ISO sensitivity settings]</b> &gt; <b>[Auto ISO sensitivity control]</b> and the time chosen for <b>[Minimum shutter speed]</b> is longer than the interval, the time selected for the interval will take priority over the selected shutter speed.</li> </ul> </li> <li>• <b>[Off]</b>: Disable interval priority to ensure that photos are correctly exposed.</li> </ul>
<b>[Focus before each shot]</b>	If <b>[On]</b> is selected, the camera will focus between shots.

Option	Description
[Options]	<p>Combine interval-timer photography with other options.</p> <ul style="list-style-type: none"> <li>• <b>[AE bracketing]</b>: Perform exposure bracketing during interval-timer photography.</li> <li>• <b>[Time-lapse movie]</b>: Use the photos taken during interval-timer photography to create a time-lapse movie with an aspect ratio of 16:9. <ul style="list-style-type: none"> <li>- The camera saves both the photos and the time-lapse movie.</li> <li>- Selecting <b>[1.2x(30×20)]</b>, <b>[5:4 (30×24)]</b>, or <b>[1:1 (24×24)]</b> for <b>[Image area]</b> &gt; <b>[Choose image area]</b> in the photo shooting menu disables the shutter release.</li> <li>- Movies created using <b>[Time-lapse movie]</b> are recorded in the <b>[sRGB]</b> color space, regardless of the option selected for <b>[Color space]</b> in the photo shooting menu.</li> </ul> </li> <li>• <b>[Off]</b>: Do not perform additional operations during interval-timer photography.</li> </ul>

Option	Description
[Starting storage folder]	<p>Highlight either of the following options and press  to select; selected items are marked with a check . To deselect (remove the check from: ) a selected option, highlight it and press  again.</p> <ul style="list-style-type: none"> <li>• <b>[New folder]</b>: A new folder is created for each new sequence.</li> <li>• <b>[Reset file numbering]</b>: File numbering is reset to 0001 whenever a new folder is created.</li> </ul>

### Before Shooting

- Take a test shot at current settings.
- Select **[Time zone and date]** in the setup menu and make sure that the camera clock is set to the correct time and date.
- We recommend using a tripod and disabling lens vibration reduction (VR).
- To ensure that shooting is not interrupted, use a fully-charged battery or an AC adapter and power connector (available separately).
- To prevent light entering via the viewfinder interfering with photographs or exposure when your eye is from the viewfinder and **[Off]** is selected for **[Silent photography]**, raise the viewfinder eyepiece shutter lever to close the viewfinder eyepiece shutter.

# Interval-Timer Photography

**1 Highlight [Interval timer shooting] in the photo shooting menu and press .**

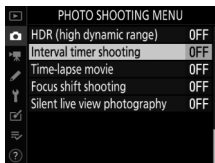

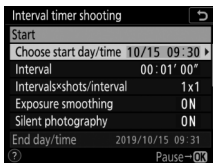

**2 Adjust interval timer settings.**

• **Choose the start day and time.**

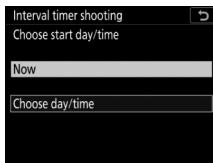

Highlight [**Choose start day/time**] and press .



Highlight an option and press .

- To start shooting immediately, select [**Now**].

- To start shooting at a chosen date and time, select [**Choose day/time**]. Choose the date and time and press .

- **Choose the interval between shots.**

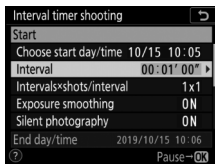

Highlight [**Interval**] and press

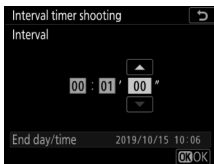

Choose an interval (in hours, minutes, and seconds) and press

- **Choose the number of shots per interval.**

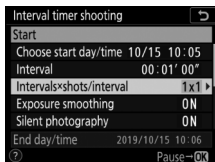

Highlight [**Intervals\*shots/interval**] and press

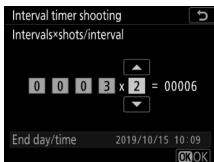

Choose the number of intervals and the number of shots per interval and press

- In release mode **S** (single frame), the photographs for each interval will be taken at the rate selected for Custom Setting d1 [**Continuous shooting speed**] > [**Continuous high-speed**].
- When [**Off**] is selected for [**Silent photography**], the maximum number of intervals will vary with the number of shots per interval.

- **Enable or disable exposure smoothing.**

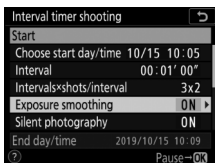

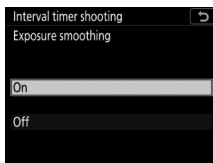

Highlight [**Exposure smoothing**] and press .



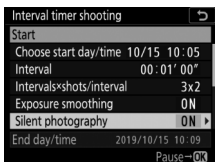

Highlight an option and press .

- **Enable or disable silent photography.**

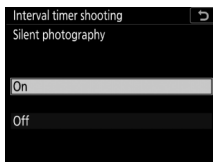

Highlight [**Silent photography**] and press .



Highlight an option and press .

- If [**On**] is selected, the only time the sound of the shutter or mirror will be heard is when the mirror is raised or lowered at the start and end of shooting.

- **Choose an interval priority option.**

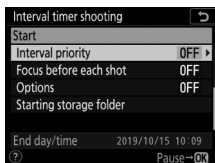

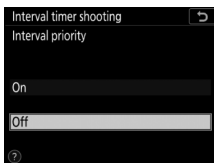

Highlight [**Interval priority**] and press .



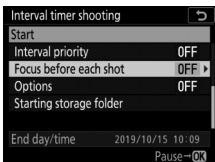

Highlight an option and press .

- **Choose whether the camera focuses between shots.**

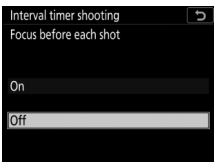

Highlight [**Focus before each shot**] and press .



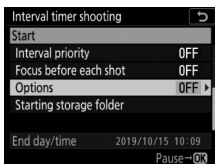

Highlight an option and press .

- **Choose additional options.**

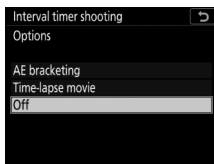

Highlight [**Options**] and press .



Highlight [**AE bracketing**] or [**Time-lapse movie**] and press .

- If you selected [**AE bracketing**], choose values for [**Number of shots**] and [**Increment**]; if you selected [**Time-lapse movie**], choose settings for [**Frame size/frame rate**] and [**Destination**].

- **Choose starting folder options.**

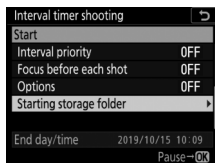

Highlight [**Starting storage folder**] and press .

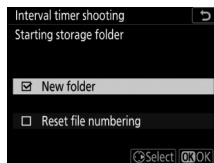

Select the desired options and press  to proceed.



### 3 Highlight [Start] and press .

- If [Now] was selected for [Choose start day/time] in Step 2, shooting will start after three seconds.
- Otherwise shooting will start at the time selected for [Choose start day/time] > [Choose day/time].
- Shooting will continue at the selected interval until all shots have been taken.

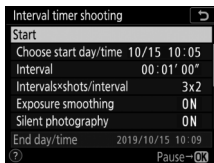

#### Interval-Timer Photography

- Choose an interval longer than the time needed to take the selected number of shots at the predicted shutter speed. Note that during actual interval-timer photography, the camera must not only take shots at the selected interval but must also have sufficient time to complete the exposures and perform such tasks as processing the photographs. If the interval is too short to take the selected number of photos, the camera may skip to the next interval without shooting.
- If the interval is too short, the total number of shots taken may be less than that selected for [Intervalsxshots/interval].
- If you are using a flash, choose an interval longer than the time needed for the flash to charge. If the interval is too short, the flash may fire at less than the power needed for full exposure.

- If shooting cannot proceed at current settings—for example, if shutter speed is set to **bulb** ("Bulb") or **-** ("Time"), **[00:00'00"]** is selected for **[Interval]**, or the start time is in less than a minute—a warning will be displayed in the monitor.
- If **[Time-lapse movie]** is selected for **[Options]**, the standby timer will not expire during interval-timer photography, regardless of the option selected for Custom Setting c2 **[Standby timer]**.
- If the memory card is full, the interval timer will remain active but no pictures will be taken. Insert another memory card and resume shooting (☐ 346).
- Interval timer shooting will pause if:
  - The camera is turned off and then on again (when the camera is off, batteries and memory cards can be replaced without ending interval-timer photography)
  - **☺** or **MUP** is selected for release mode
- Changing camera settings while the interval timer is active may cause shooting to end.

### ✔ **Release Mode**

Regardless of the release mode selected, the camera will take the specified number of shots at each interval.

### ✔ **Adjusting Settings Between Shots**

Pictures can be viewed and shooting and menu settings adjusted between shots. Note, however, that the monitor will turn off approximately 2 s before the next shot is taken.

### ✔ Interval-Timer Photography: Restrictions

Interval-timer photography cannot be combined with some camera features, including:

- Live view
- Movie recording
- Long time-exposures (“Bulb” or “Time”)
- The self-timer
- Bracketing
- Multiple exposure
- HDR (high dynamic range)
- Focus shift

### ✔ When [On] Is Selected for [Silent Photography]

Selecting [On] for [Silent photography] disables some camera features, including:

- ISO sensitivities of Hi 0.3 through Hi 5
- Flash photography
- Long exposure noise reduction
- Exposure delay mode
- Flicker reduction

### ✔ Interval Timer Settings

Turning the camera off or selecting a new release mode does not affect interval-timer photography settings.

---

---

## ✔ During Shooting

During interval-timer photography, the **INTVL** icon will flash in the top control panel.

Immediately before the next shooting interval begins, the shutter speed display will show the number of intervals remaining, and the aperture display will show the number of shots remaining in the current interval.



- Between shots, the number of intervals remaining and the number of shots in each interval can be viewed by pressing the shutter-release button halfway.
- If **[Time-lapse movie]** is selected for **[Options]**, the memory card access lamp will remain lit during interval-timer photography.

## ✔ Photo Shooting Menu Banks

Changes to interval timer settings apply to all photo shooting menu banks (A through D). Interval timer shooting will consequently continue even if you switch menu banks using the **[Photo shooting menu bank]** option in the photo shooting menu. If photo shooting menu settings are reset using the **[Photo shooting menu bank]** item in the photo shooting menu, interval timer shooting will end and interval timer settings for all banks will be reset.

---

## **Pausing Interval-Timer Photography**

Interval-timer photography can be paused between intervals by pressing **OK** or by selecting [**Interval timer shooting**] in the photo shooting menu, highlighting [**Pause**], and pressing **OK**. Note that the menus may not be displayed when the **MENU** button is pressed if the time selected for [**Interval**] is very short.

- If [**Time-lapse movie**] is selected for [**Options**], pressing **OK** between intervals will end interval-timer photography.

## Resuming Interval Timer Shooting

Shooting can be resumed using the [Interval timer shooting] item in the photo shooting menu. The procedure is as follows:

### To resume shooting immediately:

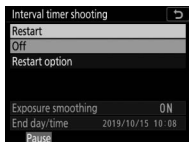

Highlight [**Restart**] and press **OK**.

### To resume shooting at a specified time:

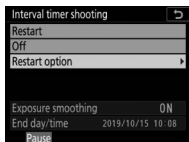

Select [**Choose start day/time**], highlight [**Choose day/time**] and press **OK**.

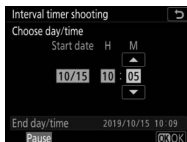

Choose a starting date and time and press **OK**.

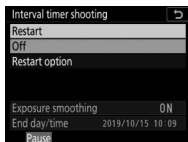

Highlight [**Restart**] and press **OK**.

## **Ending Interval Timer Shooting**

To end interval-timer photography before all the photos are taken, select [**Interval timer shooting**], highlight [**Off**], and press **OK**. Note that the menus may not be displayed when the **MENU** button is pressed if the time selected for [**Interval**] is very short. In this case you will need to press **OK** to pause interval-timer photography and then select [**Interval timer shooting**] in the photo shooting menu, highlight [**Off**], and press **OK**.

## Creating a Movie from Photos (Time-Lapse Movie)

Use the [**Time-lapse movie**] item in the photo shooting menu to create silent time-lapse movies from photos taken automatically at a selected interval.

### Time-Lapse Movie Options

Option	Description
[ <b>Start</b> ]	Start time-lapse recording. Shooting starts after about 3 s and continues at the interval selected for [ <b>Interval</b> ] for the time selected for [ <b>Shooting time</b> ].
[ <b>Interval</b> ]	Choose the interval between shots, in minutes and seconds.
[ <b>Shooting time</b> ]	Choose how long the camera will continue to take pictures, in hours and minutes.
[ <b>Exposure smoothing</b> ]	Selecting [ <b>On</b> ] smooths abrupt changes in exposure. <ul style="list-style-type: none"><li>• Large changes in subject brightness during shooting may result in apparent variations in exposure. This can be addressed by shortening the interval between shots.</li><li>• Exposure smoothing will not take effect in mode <b>M</b> if [<b>Off</b>] is selected for [<b>ISO sensitivity settings</b>] &gt; [<b>Auto ISO sensitivity control</b>] in the photo shooting menu.</li></ul>



Option	Description
[Silent photography]	Select [On] to silence the shutter and eliminate the vibrations it produces during shooting.
[Image area]	<ul style="list-style-type: none"> <li>• [Choose image area]: Choose the image area for time-lapse movies from [FX] and [DX].</li> <li>• [Auto DX crop]: If [On] is selected, the camera will automatically choose the [DX] crop when a DX lens is attached.</li> </ul>
[Frame size/ frame rate]	Choose the frame size and rate for the final movie.
[Interval priority]	<ul style="list-style-type: none"> <li>• [On]: Enable interval priority to ensure that frames shot in modes <b>P</b> and <b>A</b> are taken at the chosen interval. <ul style="list-style-type: none"> <li>- If <b>AF-S</b> is selected for autofocus mode, select [Release] for Custom Setting a2 [<b>AF-S priority selection</b>]. If <b>AF-C</b> is selected, select [Release] for Custom Setting a1 [<b>AF-C priority selection</b>].</li> <li>- If [On] is selected for [ISO sensitivity settings] &gt; [<b>Auto ISO sensitivity control</b>] and the time chosen for [<b>Minimum shutter speed</b>] is longer than the interval, the time selected for the interval will take priority over the selected shutter speed.</li> </ul> </li> <li>• [Off]: Disable interval priority to ensure that photos are correctly exposed.</li> </ul>
[Focus before each shot]	If [On] is selected, the camera will focus between shots.
[Destination]	Choose the slot used to record time-lapse movies when two memory cards are inserted.

## Recording Time-Lapse Movies

### ✓ Before Shooting

- Time-lapse movies are shot using the movie crop. Check the composition before shooting.
- Take test shots and check the results in the monitor.
- Before proceeding, select [**Time zone and date**] in the setup menu and make sure that the camera clock is set to the correct time and date.
- We recommend using a tripod and disabling lens vibration reduction (VR).
- To ensure that shooting is not interrupted, use a fully-charged battery or an AC adapter and power connector (available separately).
- To prevent light entering via the viewfinder interfering with photographs or exposure when your eye is from the viewfinder and [**Off**] is selected for [**Silent photography**], raise the viewfinder eyepiece shutter lever to close the viewfinder eyepiece shutter.

### 1 Highlight [**Time-lapse movie**] in the photo shooting menu and press .

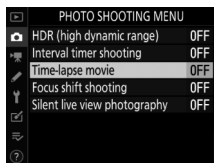

## 2 Adjust time-lapse movie settings.

- Choose the interval between shots.

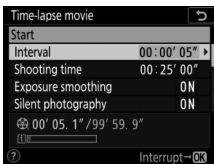

Highlight [**Interval**] and press



Choose an interval (in minutes and seconds) and press

- Choose an interval longer than the slowest anticipated shutter speed.

- Choose the total shooting time.

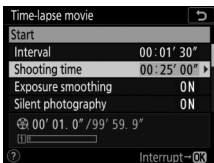

Highlight [**Shooting time**] and press

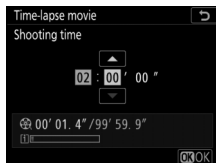

Choose a shooting time (in hours and minutes) and press

- The maximum shooting time is 7 hours and 59 minutes.

- **Enable or disable exposure smoothing.**

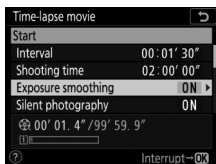

Highlight [**Exposure smoothing**] and press .

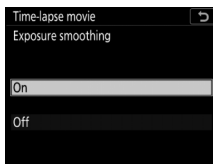

Highlight an option and press .

- Selecting [**On**] smooths abrupt changes in exposure.

- **Enable or disable silent photography.**

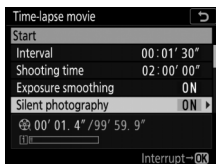

Highlight [**Silent photography**] and press .

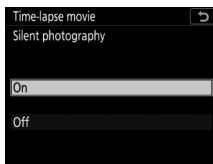

Highlight an option and press .

- If [**On**] is selected, the only time the sound of the shutter or mirror will be heard is when the mirror is raised or lowered at the start and end of shooting.

## • Choose the image area.

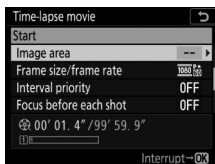

Highlight [**Image area**] and press .

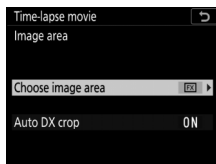

Highlight [**Choose image area**] or [**Auto DX crop**] and press .

- Highlight the desired option ((**FX**) or (**DX**) in the case of [**Choose image area**], [**On**] or [**Off**] in the case of [**Auto DX crop**]) and press .

## • Choose the frame size and rate.

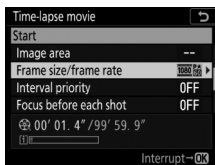

Highlight [**Frame size/frame rate**] and press .

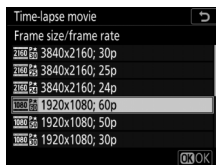

Highlight an option and press .

- Choose an interval priority option.

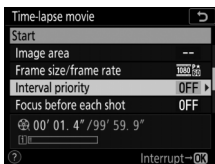

Highlight [**Interval priority**] and press

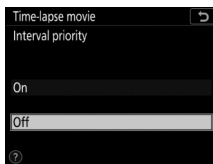

Highlight an option and press

- Choose whether the camera focuses between shots.

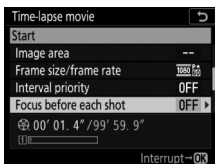

Highlight [**Focus before each shot**] and press

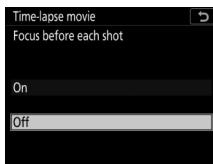

Highlight an option and press

- If [**On**] is selected for [**Focus before each shot**], the camera will focus before each shot according to the option currently selected for autofocus mode.

• **Choose a destination.**

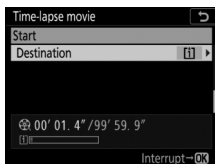

Highlight [**Destination**] and press

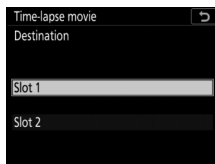

Highlight the slot that will be used to record time-lapse movies when two memory cards are inserted and press

---

### 3 Highlight [**Start**] and press .

- Shooting starts after about 3 s.
- The camera takes pictures at interval selected for [**Interval**] for the time selected for [**Shooting time**] in Step 2.



## Ending Shooting

To end shooting before all the photos are taken, press **OK** or select [**Time-lapse movie**] in the photo shooting menu, highlight [**Off**], and press **OK**. Note that the menu may not be displayed when the **MENU** button is pressed if the time selected for [**Interval**] is very short.

- A movie will be created from the frames shot to the point where shooting ended and normal photography will resume.

## Calculating the Length of the Final Movie

- The total number of frames in the final movie can be calculated by dividing the shooting time selected in Step 2 by the interval, rounding up, and adding 1.
- The length of the final movie can then be calculated by dividing the number of shots by the frame rate selected for [**Frame size/frame rate**] (for example, a 48-frame movie recorded with [**1920 × 1080; 24p**] selected for [**Frame size/frame rate**] will be about two seconds long).
- The maximum length for time-lapse movies is 20 minutes.

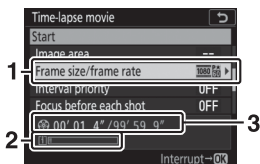

- |   |                                |
|---|--------------------------------|
| 1 | Frame size/frame rate          |
| 2 | Memory card indicator          |
| 3 | Length recorded/maximum length |



## ✔ Image Review

The  button cannot be used to view pictures while shooting is in progress. The current frame will however be displayed for a few seconds after each shot if **[On]** is selected for **[Image review]** in the playback menu. Note that other playback operations cannot be performed while the frame is displayed. The current frame may not be displayed if the interval is very short.

## ✔ Time-Lapse Movies

- Sound is not recorded with time-lapse movies.
- The shutter speed and the time needed to record the image to the memory card may vary from shot to shot. As a result, the interval between a shot being recorded and the start of the next shot may vary.
- Shooting will not begin if a time-lapse movie cannot be recorded at current settings, for example if:
  - The value selected for **[Interval]** is longer than that selected for **[Shooting time]**
  - **[00:00'00"]** is selected for **[Interval]** or **[Shooting time]**
  - **[On]** is selected for both **[Silent photography]** and **[Interval priority]** and **[00:00'0.5"]** is selected for **[Interval]**
  - The memory card is full
- The  button cannot be used to view pictures while time-lapse recording is in progress.
- For consistent coloration, choose a white balance setting other than **[Auto]** or **[Natural light auto]** when recording time-lapse movies.
- Regardless of the option selected for Custom Setting c2 **[Standby timer]**, the standby timer will not expire while recording is in progress.

- Shooting may end if camera controls are used, settings are changed, or an HDMI cable is connected. A movie will be created from the frames shot to the point where shooting ended.
- The following end shooting without a beep sounding or a movie being recorded:
  - Disconnecting the power source
  - Ejecting the memory card

### ✓ **During Shooting**

- During shooting, **INTVL** and the time-lapse recording indicator will be displayed in the top control panel. The time remaining (in hours and minutes) appears in the shutter-speed display immediately before each frame is recorded.
- At other times, the time remaining can be viewed by pressing the shutter-release button halfway.

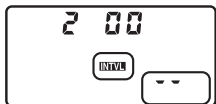

### ✓ **Adjusting Settings Between Shots**

Shooting and menu settings can be adjusted between shots. Note, however, that the monitor will turn off approximately 2 s before the next shot is taken.

### ✓ **Time-Lapse Movies: Restrictions**

Time-lapse movie recording cannot be combined with some camera features, including:

- Live view photography
- Movie recording
- Long time-exposures (“Bulb” or “Time”)
- The self-timer
- Bracketing
- Multiple exposure
- HDR (high dynamic range)
- Interval-timer photography
- Focus shift

### ✓ **When [On] Is Selected for [Silent Photography]**

Selecting [**On**] for [**Silent photography**] disables some camera features, including:

- ISO sensitivities of Hi 0.3 through Hi 5
  - Flash photography
  - Exposure delay mode
  - Long exposure noise reduction
  - Flicker reduction
-

## Varying Focus over a Series of Photos (Focus Shift Shooting)

The [**Focus shift shooting**] item in the photo shooting menu varies focus automatically over a series of photographs. Use it to take pictures that will later be combined via focus stacking. The photos can be copied to a computer and combined using third-party software.

### Focus Shift Shooting Options

Option	Description
[ <b>Start</b> ]	Start shooting. The camera will take the selected number of shots, changing the focus distance by the selected amount with each shot.
[ <b>No. of shots</b> ]	Choose the number of shots (maximum 300).
[ <b>Focus step width</b> ]	Focus shift varies the focus distance over a series of photographs. Choose the amount the focus distance changes with each shot.

Option	Description
<b>[Interval until next shot]</b>	The time between shots, in seconds. <ul style="list-style-type: none"> <li>• Select <b>[00]</b> to take photos at up to about 3 fps.</li> <li>• To ensure correct exposure when using a flash, choose an interval long enough for the flash to charge.</li> </ul>
<b>[First-frame exposure lock]</b>	<ul style="list-style-type: none"> <li>• <b>[On]</b>: The camera locks exposure for all shots at the setting for the first frame.</li> <li>• <b>[Off]</b>: The camera adjusts exposure before each shot.</li> </ul>
<b>[Silent photography]</b>	Select <b>[On]</b> to silence the shutter and eliminate the vibrations it produces during shooting.
<b>[Starting storage folder]</b>	Highlight either of the following options and press  to select ( <input checked="" type="checkbox"/> ) or deselect ( <input type="checkbox"/> ). <ul style="list-style-type: none"> <li>• <b>[New folder]</b>: A new folder is created for each new sequence.</li> <li>• <b>[Reset file numbering]</b>: File numbering is reset to 0001 whenever a new folder is created.</li> </ul>

---

## ✔ Before Shooting

- Use an AF-S or AF-P lens.
  - Choose a release mode other than .
  - For best results, we recommend that you choose mode **A** or **M** so that aperture does not change during shooting.
  - We recommend that you stop aperture down two or three stops from the maximum.
  - We recommend that you take all shots at the same ISO sensitivity.
  - Take a test shot at current settings.
  - We recommend using a tripod and disabling lens vibration reduction (VR).
  - To ensure that shooting is not interrupted, use a fully-charged battery or an AC adapter and power connector (available separately).
  - To prevent light entering via the viewfinder interfering with photographs or exposure when your eye is from the viewfinder and [**Off**] is selected for [**Silent photography**], raise the viewfinder eyepiece shutter lever to close the viewfinder eyepiece shutter.
-

# Focus Shift Photography

---

## 1 Rotate the focus-mode selector to AF.

Focus shift is not available with manual focus lenses.

---

## 2 Focus.

- During focus shift, the camera takes a series of shots starting from a selected focus position and continuing toward infinity. The starting focus position should be slightly in front of the closest point on the subject.
  - Do not move the camera after focusing.
- 

## 3 Highlight [Focus shift shooting] in the photo shooting menu and press .

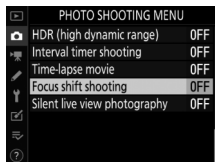

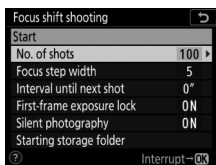

## 4 Adjust focus shift settings.

- Choose the number of shots.

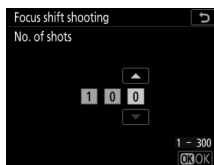

Highlight [**No. of shots**] and press .



Choose the number of shots and press .

- The maximum number of shots is 300.
- We recommend taking more shots than you think you'll need. You can winnow them down during focus stacking.
- More than 100 shots may be required for photographs of insects or other small objects. On the other hand, only a few may be needed to photograph a landscape from front to back with a wide-angle lens.



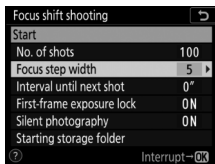

- **Choose the amount the focus distance changes with each shot.**

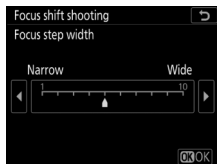

Highlight [**Focus step width**] and press .



Choose a focus step width and press .

- Press  to reduce the focus step width,  to increase.
- Note that high settings increase the risk that some areas will be out of focus when the shots are stacked. A value of 5 or less is recommended.
- Try experimenting with different settings before shooting.

## • Choose the interval between shots.

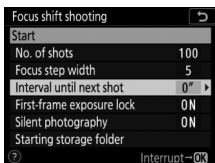

Highlight [**Interval until next shot**] and press .

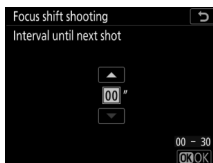

Choose the interval between shots (in seconds) and press .

- Choose the interval between shots, in seconds.
- Select [**00**] to take photos at up to approximately 3 fps.
- To ensure correct exposure when using a flash, choose an interval long enough for the flash to charge. A setting of [**00**] is recommended when shooting without a flash.

## • Enable or disable first-frame exposure lock.

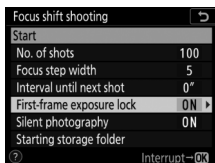

Highlight [**First-frame exposure lock**] and press .

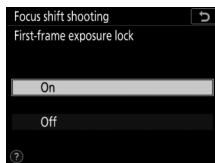



Highlight an option and press .

- [**Off**] is recommended if lighting and other conditions will not change during shooting, [**On**] when photographing landscapes and the like under variable lighting.
- Selecting [**On**] locks exposure at the value for the first shot, ensuring that all photos have the same exposure. Large changes in subject brightness during shooting may however result in apparent variations in exposure. This can be addressed by selecting [**Off**].

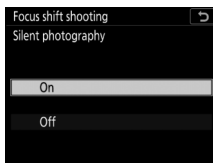
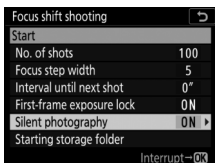
## • Enable or disable silent photography.



Highlight [**Silent photography**] and press .

Highlight an option and press .

- If [**On**] is selected, the only time the sound of the shutter or mirror will be heard is when the mirror is raised or lowered at the start and end of shooting.

- **Choose starting folder options.**

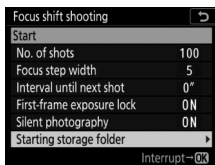

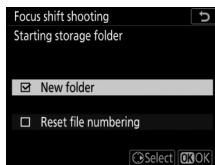

Highlight [**Starting storage folder**] and press  $\blacktriangleleft$ .



Select the desired options and press  $\text{OK}$  to proceed.

- Highlight an option and press  $\blacktriangleleft$  to select; selected items are marked with a check (). To deselect (remove the check from: ) a selected option, highlight it and press  $\blacktriangleleft$  again.
- Place a check () next to [**New folder**] to create a new folder for each new sequence.
- Place a check () next to [**Reset file numbering**] to reset file numbering to 0001 whenever a new folder is created.

## 5 Highlight [Start] and press .

- Shooting starts after about 3 s.
- The camera takes photographs at the selected interval, starting at the focus distance selected at the start of shooting and progressing out toward infinity by the selected focus step distance with each shot.
- Shooting ends when the selected number of shots has been taken or focus reaches infinity.
- To end shooting before all shots have been taken, either:
  - select [**Focus shift shooting**] in the photo shooting menu, highlight [**Off**], and press ,
  - press the shutter-release button halfway or press the  button between shots.

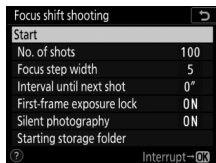

---

### ✔ Focus Shift Photography

- The shutter speed and the time needed to record the image may vary from shot to shot. As a result, the interval between a shot being recorded and the start of the next shot may vary.
- Regardless of the option selected for Custom Setting c2 [**Standby timer**], the standby timer will not expire while shooting is in progress.
- If you are using a flash, choose an interval longer than the time needed for the flash to charge. If the interval is too short, the flash may fire at less than the power needed for full exposure.
- If shooting cannot proceed at current settings, for example because shutter speed is set to **BULB** ("Bulb") or **-** ("Time"), a warning will be displayed.
- Changing camera settings while focus shift photography is in progress may cause shooting to end.

### ✔ Adjusting Settings Between Shots

Shooting and menu settings adjusted between shots. Note, however, that the monitor will turn off approximately 2 s before the next shot is taken.

---

## ✔ Close-ups

Because focus depth is reduced at short focus distances, we recommend choosing smaller focus steps and increasing the number of shots when photographing subjects close to the camera.

## ✔ During Shooting

During focus shift photography, the **INTVL** icon will flash in the top control panel. Immediately before each shot, the AF indicator will flash and the shutter speed display will show the number of shots remaining.

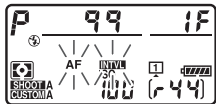



## **Focus Shift Photography: Restrictions**

- Focus shift shooting will not start if:
  - The camera clock is not set
  - An incompatible lens is attached (use only AF-S or AF-P lenses)
  - No memory card is inserted
- Focus-shift photography cannot be combined with some camera features, including:
  - Live view
  - Movie recording
  - Long time-exposures (“Bulb” or “Time”)
  - The self-timer
  - Bracketing
  - Multiple exposure
  - HDR (high dynamic range)
  - Interval-timer photography
  - Time-lapse movies

## **When [On] Is Selected for [Silent Photography]**

Selecting **[On]** for **[Silent photography]** disables some camera features, including:

- ISO sensitivities of Hi 0.3 through Hi 5
  - Flash photography
  - Long exposure noise reduction
  - Exposure delay mode
  - Flicker reduction
-

## The Electronic Shutter (Silent Live View Photography)

To enable the electronic shutter during live view photography, muting the shutter and eliminating the vibrations it produces, select **[On]** for **[Silent live view photography]** in the photo shooting menu. Use for landscapes, still lifes, and other static subjects.

- Use of a tripod is recommended.
- Enabling silent live view photography changes the frame advance rates for continuous release modes (📖 205).

---

## Silent Live View Photography

- The amount of time you can continue shooting is shown in place of the number of exposures remaining.
- Selecting [On] for [Silent live view photography] does not completely silence the camera. Camera sounds may still be audible, for example during autofocus or aperture adjustment.
- During silent live view photography, you may notice the following in the display and in photographs recorded with the camera.
  - Flicker or banding in scenes lit by such sources as fluorescent, mercury vapor, or sodium lamps
  - Distortion associated with motion (individual subjects such as trains or cars moving at high speed through the frame may be distorted, or the entire frame may appear distorted when the camera is panned horizontally)
  - Jagged edges, color fringing, *moiré*, and bright spots
  - Bright regions or bands in scenes lit by flashing signs and other intermittent light sources or when the subject is briefly illuminated by a strobe or other bright, momentary light source
- In continuous release modes, focus is fixed at the values for the first shot in each series.
- Silent photography mutes the shutter, but this does not absolve photographers of the need to respect their subjects' privacy and image rights.

## **Silent Photography**

Some camera features, including the following, cannot be combined with silent live view photography:

- ISO sensitivities of Hi 0.3 through Hi 5
  - Flash photography
  - Long exposure noise reduction
-

## Customizing the **i** Menu: Customize **i** Menu

Choose the items displayed in the **i** menu during shooting. Use Custom Setting f1 [**Customize **i** menu**] to choose the items displayed during viewfinder photography, Custom Setting f2 [**Customize **i** menu (Lv)**] to choose the items displayed during live view photography, and Custom Setting g1 [**Customize **i** menu**] to choose the items displayed during movie recording. The procedure for customizing the **i** menu is described below.

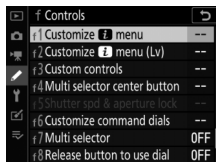

### 1 Highlight the position you want to change and press **OK**.

A list of the items available for the selected position will be displayed.



---

## 2 Highlight the desired item and press **OK**.

- The item will be assigned to the selected position and the options shown in Step 1 will be displayed.
- Repeat Steps 1 and 2 as desired.

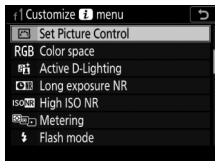

---

## 3 Press the MENU button.

Changes will be saved and the Custom Settings menu will be displayed.

## Using Non-CPU Lenses (Non-CPU Lens Data)

Non-CPU lenses (☐ 1045) can be used in exposure modes **A** and **M**. Aperture is set using the lens aperture ring. Entering lens data using the **[Non-CPU lens data]** item in the setup menu grants access to the following CPU lens functions.

- **Entering the focal length:**

- allows use of power zoom with optional flash units and
- allows lens focal length to be listed, with an asterisk ("\*"), in the playback photo info display.

- **Entering the maximum aperture:**

- allows the aperture value to be displayed in the top control panel and viewfinder,
- allows flash level to be adjusted for changes in aperture in auto aperture (⊗A) mode, and
- allows aperture to be listed, with an asterisk ("\*"), in the playback photo info display.

- **Entering both the focal length and the maximum aperture allows use of:**
    - color matrix metering (Note that color matrix metering may not produce the desired results with some lenses, including Reflex-NIKKOR lenses. In these cases [**Center-weighted metering**] or [**Spot metering**] can be used instead.)
  - **Entering both the focal length and the maximum aperture improves the precision of:**
    - [**Center-weighted metering**],
    - [**Spot metering**], and
    - i-TTL flash control
- 

### ✓ **Teleconverters and Zoom Lenses**

- If the correct focal length is not available, for example because you are using a teleconverter or zoom lens, choose the next largest value.
  - The maximum aperture for teleconverters is the combined maximum aperture of the teleconverter and the lens.
-



# Entering Lens Data

## 1 Highlight [Non-CPU lens data] in the setup menu and press



## 2 Highlight [Lens number].

Press or to choose a lens number.

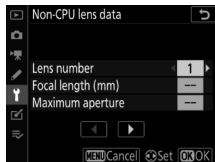

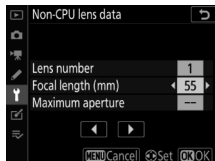

## 3 Highlight [Focal length (mm)].

Press or to enter the lens focal length.



---

## 4 Highlight [Maximum aperture].

Press  or  to enter the maximum aperture.

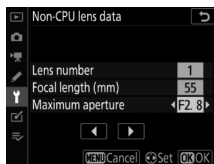

---

## 5 Press to save changes.

Lens information will be saved and the camera will exit to the setup menu.

## Recalling Non-CPU Lens Data

**1** Assign [Choose non-CPU lens number] to a control using Custom Setting f3 [Custom controls].

**2** Hold the control to which [Choose non-CPU lens number] has been assigned and rotate a command dial.

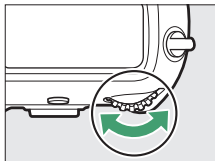

The selected lens number is displayed in the top control panel. Rotate the dial until the desired lens number is displayed.



- 1** Focal length
- 2** Maximum aperture
- 3** Lens number

### Zoom Lenses

Lens data are not adjusted when non-CPU lenses are zoomed in or out. Edit lens data after adjusting zoom.



## Location Data

The built-in location data unit records the camera's current latitude, longitude, and altitude, together with the current time (Coordinated Universal Time, or UTC). Location data embedded in pictures can be viewed in the location data page of the playback photo info display (☐ 414).

### Location Data Options





To enable or disable the location data function or adjust location data settings, highlight [**Location data (built-in)**] in the setup menu and press .

Option	Description
[ <b>Record location data</b> ]	Select [ <b>On</b> ] to enable the location data function.
[ <b>Standby timer</b> ]	If [ <b>Enable</b> ] is selected when [ <b>Record location data</b> ] is set to [ <b>On</b> ], the standby timer will expire if no operations are performed for the period chosen using Custom Setting c2 [ <b>Standby timer</b> ]. Choose this option to reduce the drain on the battery.
[ <b>Set clock from satellite</b> ]	Select [ <b>Yes</b> ] to set the camera clock to the time reported by the location data function.

Option	Description
[Create log]	<p>Record a track log.</p> <ul style="list-style-type: none"> <li>• <b>[Log location data]</b>: The camera will log location data at the interval chosen using <b>[Log interval]</b> for the time selected for <b>[Log length]</b>. To end, pause, or resume the log, highlight <b>[Log location data]</b> and press .</li> <li>• <b>[Log interval]</b>: Choose how often the camera logs its current location.</li> <li>• <b>[Log length]</b>: Choose how long logging will continue.</li> </ul>
[Log list]	<p>List track logs by date.</p> <ul style="list-style-type: none"> <li>• Where multiple logs were recorded on the same day, an identifier appears after the date.</li> <li>• The camera can store up to 100 track logs.</li> <li>• To delete a log, highlight it and press  (FORMAT).</li> </ul>
[Position]	<p>View the latitude, longitude, altitude, and Coordinated Universal Time (UTC) currently reported by the built-in location data unit. UTC data are provided by the built-in location data unit independently of the camera clock.</p>

## ■ The Satellite Signal Indicator

Signal strength is shown by a  icon in the top control panel.

-  **(static)**: The camera records the current latitude, longitude, and altitude.
-  **(flashing)**: The camera is unable to determine its location from the satellite signal; location data are not recorded. Wait for the  icon to stop flashing.
-  **not displayed**: The  icon clears from the display if no signal is received for two seconds. Location data will not be recorded with pictures taken when the icon is not displayed. Note, however, that location data previously acquired may be recorded with pictures taken after the icon has cleared from the display.

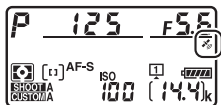

---

## Location Data

- The camera may in certain cases need additional time to acquire location data, for example immediately after the battery is inserted, when the location data function is enabled for the first time, or after an extended period of disuse.
- The positions of navigation satellites change constantly. This may slow or prevent the acquisition of location data in some locations or at certain hours of the day.
- Satellite signals may be blocked or reflected in the locations listed below, rendering the data acquired less accurate or preventing its acquisition altogether.
  - In buildings or under ground
  - Between tall buildings
  - Under bridges
  - In tunnels
  - Near power lines or similar structures
  - In dense forest
  - In metal briefcases or other containers
- The presence of cellular telephones or other devices that transmit on frequencies close to those of navigation satellites may interfere with the acquisition of location data.

- The location reported by the camera may differ from its actual location by up to several hundred meters.
- The location data recorded with movies are those reported at the start of recording.
- The location data embedded in pictures may differ from the location in which they were actually recorded.
- Turning the camera off does not disable the location data function. The location data function can be disabled by selecting **[Off]** for **[Location data (built-in)] > [Record location data]** in the setup menu.

### **Track Logs**

- Track logs will not be recorded if the camera clock is not set or if no memory card is inserted.
- To prevent logs being interrupted, be sure the camera battery is fully charged.
- Tracking ends if:
  - the camera battery runs low,
  - the battery is removed, or
  - **[Off]** is selected for **[Location data (built-in)] > [Record location data]**.
- Location data will not be logged while the camera is unable to acquire a satellite signal.



## Track Logs

- The time remaining appears in the **[Location data (built-in)]** display while logging is in progress.
- Logs are not interrupted when the camera is turned off or the standby timer expires. Be sure to monitor the battery level while logging is in progress.
- Logs are stored in the “NIKON” > “GNSS” folder on the memory card and have names of the form “Nyymmddx.log”. Here “yy” is the last two digits of the current year, “mm” the month, “dd” the day, “x” a single-character identifier from 0 (zero) to Z assigned in ascending order by the camera, and “.log” the extension (thus the first log recorded on October 15, 2019, will be named “N1910150.log”).
- Logs are in NMEA format. There is however no guarantee that they will display correctly in all software or on all devices.

## SnapBridge

- Using the SnapBridge app, location data can be downloaded to the camera from a smartphone or tablet (smart device) via a wireless link even when location data cannot be acquired using the camera’s built-in location data unit.
  - Location data downloaded from the smart device will be recorded with pictures even if **[Off]** is selected for **[Location data (built-in)]** > **[Record location data]**. Location data recording can be ended by disabling the location data feature in the SnapBridge app.
-





# Playback

## Viewing Pictures

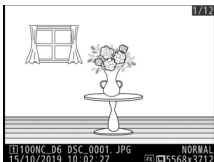
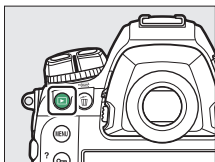

### Full-Frame Playback

Press the  button to view the most recent picture full frame.







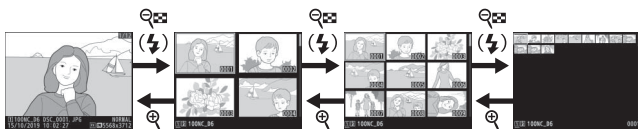
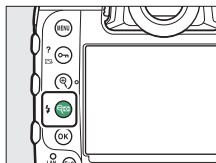

- Additional pictures can be viewed using the multi selector: press  to view pictures in the order recorded,  to view pictures in reverse order.
- To view more information on the current picture, press  or  (see page 405).

## Thumbnail Playback





To view multiple pictures, press the  () button when a picture is displayed full frame.

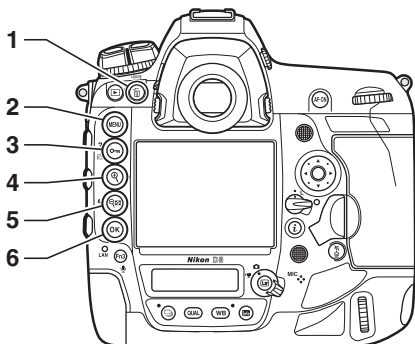

- The number of pictures displayed increases from 4 to 9 to 72 each time the  () button is pressed, and decreases with each press of the  button.
- Highlight pictures using , , , or .













## Playback Controls



- 1 : Delete the current picture (☞ 429).
- 2 **MENU**: View the menus (☞ 80).
- 3 : Protect the current picture (☞ 421).
- 4 : Zoom in (☞ 419).
- 5 : View multiple pictures (☞ 391).
- 6  button

## ■ The Button and Multi Selector

The following operations can be performed by holding  and pressing the multi selector as indicated.

Option	Description
 + 	Display [ <b>Choose slot and folder</b> ] options. Highlight a slot and press  to display a list of the folders on the memory card in the selected slot. You can then highlight a folder and press  to view the pictures it contains.
 + 	If the current picture is a photograph, retouch options will be displayed.
 + 	View the IPTC presets created using the [ <b>IPTC</b> ] option in the setup menu. To embed an IPTC preset in the current photo, highlight the preset and press  (any preset already embedded in the current photo will be replaced).
 + 	Upload the current picture to a computer or ftp server over a wireless or Ethernet network in image transfer mode (  587).

---

## ✔ Touch Controls

Touch controls can be used when pictures are displayed in the monitor (📖 18).

## ✔ Rotate Tall

To display “tall” (portrait-orientation) photographs in tall orientation, select **[On]** for **[Rotate tall]** in the playback menu.



---

## ✔ Two Memory Cards

If two memory cards are inserted, **[Choose slot and folder]** options can also be viewed by pressing the **Q** (🔌) button when 72 thumbnails are displayed.

## ✔ Image Review

When **[On]** is selected for **[Image review]** in the playback menu, photographs are automatically displayed in the monitor after shooting; there is no need for you to press the **▶** button.

- In **CH** and **CL** modes and during burst photography in mode **Q**, display begins when shooting ends, with the first photograph in the current series displayed.
  - Because the camera will already be in the correct orientation, images are not rotated during image review even if **[On]** is selected for **[Rotate tall]** in the playback menu.
-

## **Playback Touch Controls**

During playback, the touch-sensitive monitor can be used for the operations below.

### **■ Viewing Other Pictures**

Flick left or right to view other pictures.

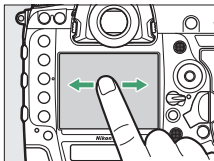

### **■ Scrolling Rapidly to Other Pictures**

Touching the bottom of the screen in full-frame view displays a frame advance bar. Slide your finger left or right along the bar to scroll rapidly to other pictures.

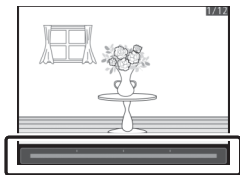
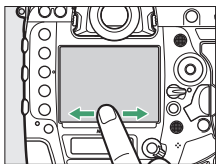

## ■ Zoom (Photos Only)

Double-tap or use stretch gestures to initiate zoom during full-frame playback (📖 418).

- Stretch again to zoom in further.
- Pinch to zoom out.
- Glide to scroll.
- Double-tap to cancel zoom.

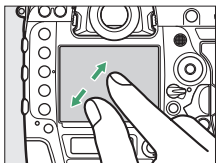

## ■ Viewing Thumbnails

Use a pinch gesture to “zoom out” from full-frame playback to a thumbnail view (📖 391).

- Use pinch and stretch to choose the number of images displayed from 4, 9, and 72 frames.

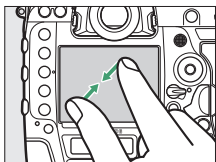



## ■ Viewing Movies

Tap the on-screen guide to start movie playback (movies are indicated by a  icon).

- Tap the display to pause. Tap again to resume.
- To exit to full-frame playback, tap .
- Note that some of the icons in the movie playback display do not respond to touch-screen operations.

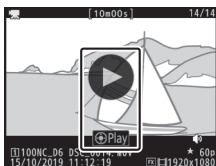

---

## ✔ Vertical Flick Gestures

To choose the operations performed by flicking up or down during full-frame playback, use Custom Setting f12 [**Full-frame playback flicks**].

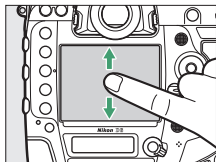

- Choose from the following options.
    - [**Rating**]: Assign the current picture a previously-selected rating.
    - [**Select to send (wired LAN/WT)**]: Select the current picture for upload to a computer or ftp server via Ethernet or wireless transmitter.
    - [**Protect**]: Protect the current picture.
    - [**Voice memo**]: Record a voice memo or play the voice memo for the current picture.
    - [**None**]: Flicking in the selected direction has no effect.
  - In the case of [**Rating**], [**Select to send (wired LAN/WT)**], and [**Protect**], the operation can be undone by flicking again in the same direction.
-

## The **i** Button



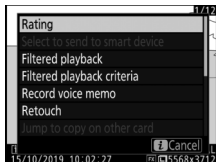
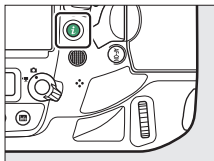

Pressing the **i** button during playback zoom or full-frame or thumbnail playback displays the **i** menu for playback mode. Highlight items and press **OK** or **▶** to select.

Press the **i** button again to return to playback.



## ■ Photos

Option	Description
[Quick crop] <sup>1</sup>	Save a copy of the current image cropped to the area visible in the display. This option is not available when RGB histograms are displayed (☞ 408).
[Rating]	Rate the current picture (☞ 423).
[Select to send to smart device]	
[Select to send to computer]	Select the current picture for upload. The option displayed varies with the type of device connected.
[Select to send (wired LAN/WT)]	
[Filtered playback]	View only pictures that match selected criteria (☞ 427).
[Filtered playback criteria]	Choose filter criteria.
[Record voice memo]	Add a voice memo to the current picture (☞ 440).
[Play voice memo]	Play the voice memo for the current picture (☞ 443).
[Retouch]	Create a retouched copy of the current picture (☞ 958).

Option	Description
<b>[Jump to copy on other card]</b>	If the current picture is one of a pair created with <b>[Backup]</b> , <b>[RAW Slot 1 - JPEG Slot 2]</b> , or <b>[JPEG Slot 1 - JPEG Slot 2]</b> selected for <b>[Role played by card in Slot 2]</b> , choosing this option displays the copy on the card in the other slot.
<b>[Choose slot and folder]</b>	Choose a slot and folder for playback. Highlight a slot and press  to display a list of the folders on the memory card in the selected slot. You can then highlight a folder and press  to view the pictures it contains.
<b>[Select R, G, B]</b> <sup>2</sup>	Press  or  to choose a color channel for the highlight display.
<b>[IPTC]</b>	Embed a selected IPTC preset in the current photo (  914).
<b>[Side-by-side comparison]</b> <sup>3</sup>	Compare retouched copies to the originals.

- 1 Available only during playback zoom.
- 2 Available only when highlights or RGB histograms are displayed.
- 3 Available only when a retouched copy (indicated by a  icon) or the source picture for a retouched copy is selected.

---

## ✔ Side-by-Side Comparison



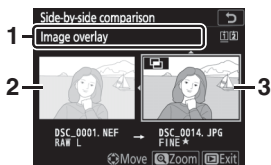

Choose [**Side-by-side comparison**] to compare retouched copies with the unretouched originals.



- 1 Options used to create copy
- 2 Source image
- 3 Retouched copy





- The source image is displayed on the left, the retouched copy on the right.
  - The options used to create the copy are listed at the top of the display.
  - Press or to switch between the source image and the retouched copy.
  - If the copy is an overlay created from multiple source images, press or to view the other images.
  - If the source has been copied multiple times, press or to view the other copies.
  - To view the highlighted picture full screen, press and hold the button.
  - Press to return to playback with the highlighted image displayed full screen.
  - The source image will not be displayed if the copy was created from a photograph that is now protected.
  - The source image will not be displayed if the copy was created from a photograph that has since been deleted or hidden.
-

## ■ Movies

Option	Description
[Rating]	Rate the current picture (□ 423).
[Select to send to computer]	Select the current picture for upload. The option displayed varies with the type of device connected.
[Select to send (wired LAN/WT)]	
[Filtered playback]	View only pictures that match selected criteria (□ 427).
[Filtered playback criteria]	Choose filter criteria.
[Volume control]	Adjust playback volume.
[Trim movie]	Trim footage from the current movie and save the edited copy in a new file (□ 300).
[Choose slot and folder]	Choose a slot and folder for playback. Highlight a slot and press  to display a list of the folders on the memory card in the selected slot. You can then highlight a folder and press  to view the pictures it contains.
[Select R, G, B] *	Press  or  to choose a color channel for the highlight display.



\* Available only when highlights or RGB histograms are displayed.

## ■ Movies (Playback Paused)

	Option	Description
	<b>[Choose start/end point]</b>	Trim footage from the current movie and save the edited copy in a new file (📖 300).
	<b>[Save current frame]</b>	Save a selected frame as a JPEG still (📖 306).
	<b>[Add index]</b>	Add indices to movies during playback. Indices can be used to quickly locate frames during playback and editing (📖 307).
	<b>[Delete index]</b>	Delete indices (📖 307).



## Photo Information

Photo information is superimposed on images displayed in full-frame playback. Press  or  to cycle through photo information as shown below.

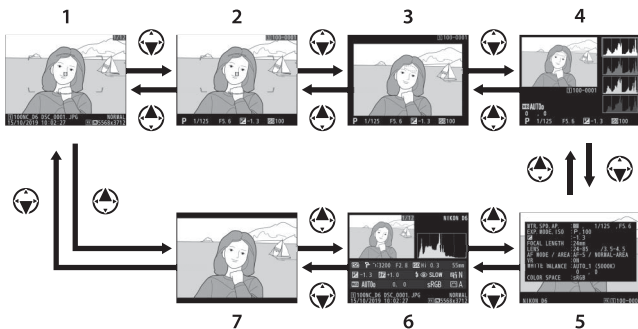

- 1 File information
- 2 Exposure data \*
- 3 Highlights \*
- 4 RGB histogram \*

- 5 Shooting data \*
- 6 Overview data \*
- 7 None (image only) \*

\* Displayed only if the corresponding option is selected for **[Playback display options]** in the playback menu.

## File Information

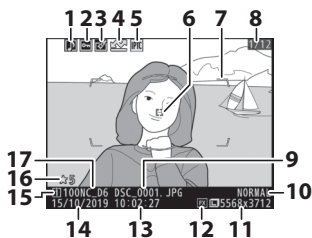

- 1 Voice memo indicator (☞ 436)
- 2 Protect status (☞ 421)
- 3 Retouch indicator (☞ 958)
- 4 Upload marking (☞ 425)
- 5 IPTC preset indicator (☞ 400, 914)
- 6 Focus point <sup>1</sup> (☞ 164)
- 7 AF-area brackets <sup>2</sup> (☞ 164)
- 8 Frame number/total number of frames
- 9 File name (☞ 760)
- 10 Image quality (☞ 118, 144)
- 11 Image size (☞ 120, 145)
- 12 Image area (☞ 136)
- 13 Time of recording (☞ 43)
- 14 Date of recording (☞ 43)
- 15 Current card slot (☞ 38)
- 16 Rating (☞ 423)
- 17 Folder name (☞ 755)

- 1 Displayed only if **[Focus point]** is selected for **[Playback display options]** in the playback menu.
- 2 Displayed only if **[Focus point]** is selected for **[Playback display options]** in the playback menu and the picture was taken during viewfinder photography.

## Exposure Data

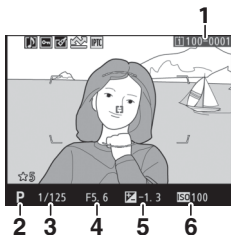

- 1 Folder number–frame number (☐ 755)
- 2 Exposure mode (☐ 108, 182)
- 3 Shutter speed (☐ 185, 188)
- 4 Aperture (☐ 186, 188)
- 5 Exposure compensation (☐ 117, 199)
- 6 ISO sensitivity \* (☐ 114, 213)

\* Displayed in red if the picture was taken with auto ISO sensitivity control enabled.

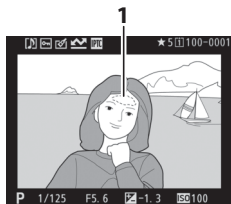

## Highlights

To choose a color channel for the highlight display, choose [Select R, G, B] in the **i** menu and press **⏪** or **⏩**.



- 1 Highlights (areas that may be overexposed)

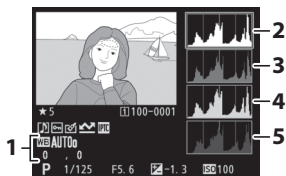

## RGB Histogram

To choose a color channel for the highlight display, choose [Select R, G, B] in the *i* menu and press  or .



- 1 White balance (📖 121, 221)  
Color temperature (📖 231)  
Preset manual (📖 234)  
White balance fine-tuning (📖 227)
- 2 Histogram (RGB channel)
- 3 Histogram (red channel)
- 4 Histogram (green channel)
- 5 Histogram (blue channel)

### ✓ Playback Zoom

To zoom in on the picture in the histogram display, press . The histogram will be updated to show only the data for the portion of the image visible in the display. Use the multi selector to scroll. Press  to zoom out.



## ✔ Histograms

Histograms show tone distribution. Pixel brightness (tone) is plotted on the horizontal axis and the number of pixels on the vertical axis.

- If the image contains objects with a wide range of brightnesses, the distribution of tones will be relatively even.



- If the image is dark, the distribution will be shifted to the left.



- If the image is bright, the distribution will be shifted to the right.





Increasing exposure compensation shifts the distribution of tones to the right, while decreasing exposure compensation shifts the distribution to the left.

Histograms can provide a rough idea of overall exposure when bright ambient lighting makes it difficult to see pictures in the monitor.

## ✔ The Histogram Display

- RGB histograms show tone distribution.
  - Camera histograms may differ from those displayed in imaging applications. Use them as a guide to actual tone distribution.
-

## Shooting Data

View the settings in effect at the time the picture was taken. The shooting data list has multiple pages, which can be viewed by pressing  or . The information displayed can be selected using [Playback display options] > [Detailed shooting data] in the playback menu.

### Basic Shooting Data

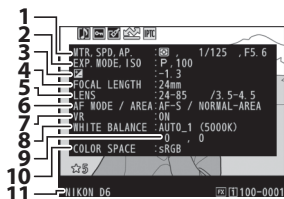

- 1 Metering (📖 111, 178)  
Shutter speed (📖 185, 188)  
Aperture (📖 186, 188)
- 2 Exposure mode (📖 108, 182)  
ISO sensitivity <sup>1</sup> (📖 114, 213)

- 3 Exposure compensation (📖 117, 199)  
Optimal exposure tuning <sup>2</sup> (📖 821)
- 4 Focal length <sup>3</sup>
- 5 Lens data
- 6 Autofocus mode (📖 98, 149)  
AF-area mode (📖 101, 153)
- 7 Lens vibration reduction (VR) on/off <sup>4</sup>
- 8 White balance <sup>5</sup> (📖 121, 221)
- 9 White balance fine-tuning (📖 227)
- 10 Color space (📖 765)
- 11 Camera name

- 1 Displayed in red if the picture was taken in mode **P**, **S**, or **A** with auto ISO sensitivity control enabled.
- 2 Displayed if Custom Setting b7 [**Fine-tune optimal exposure**] has been set to a value other than zero for any metering method.
- 3 Also includes the magnification for pictures taken with a teleconverter.
- 4 Displayed only if the picture was shot with a VR lens.
- 5 Also includes the color temperature for pictures taken using [**Auto**] or [**Natural light auto**].

## Flash Data

Flash data are displayed only for pictures taken with optional flash units.

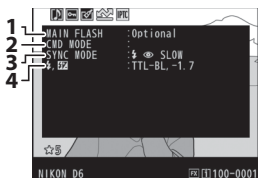

- 1 Flash type
- 2 Remote flash control
- 3 Flash mode (☐ 131, 648)
- 4 Flash control mode (☐ 645)  
Flash compensation (☐ 133, 653)  
Flash level \*

\* In the case of pictures taken using TTL flash control (☐ 645), the flash level selected by the flash unit is displayed using the equivalent manual flash output value.

## Picture Control Data



- 1 Picture Control (☐ 125, 271)

\* The items displayed vary with the Picture Control in effect when the picture was taken.



## Other Shooting Data



- 1 High ISO noise reduction (☞ 768)  
Long exposure noise reduction (☞ 767)
- 2 Active D-Lighting (☞ 281)
- 3 HDR exposure differential (☞ 283)  
HDR smoothing (☞ 283)
- 4 Vignette control (☞ 769)
- 5 Retouch history (☞ 958).  
Changes are listed in the order applied.
- 6 Image comment (☞ 911)

## Copyright Info

Copyright information is only displayed if recorded using the [Copyright information] item in the setup menu at the time the picture was taken.



- 1 Photographer (☞ 912)
- 2 Copyright holder (☞ 912)

## ■ Location Data

Location data are displayed only if embedded in the picture at the time it was taken.

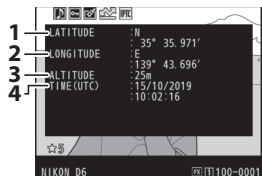

- |   |                                  |
|---|----------------------------------|
| 1 | Latitude                         |
| 2 | Longitude                        |
| 3 | Altitude                         |
| 4 | Universal Coordinated Time (UTC) |

## ■ IPTC Data



- 1 Caption
- 2 Event ID
- 3 Headline
- 4 Object Name
- 5 City
- 6 State
- 7 Country
- 8 Category
- 9 Supp. Cat. (Supplemental Categories)
- 10 Byline
- 11 Byline Title
- 12 Writer/Editor
- 13 Credit
- 14 Source

# Overview

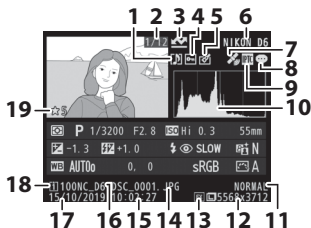

1	Voice memo indicator (☞ 436)	10	Histogram (☞ 409)
2	Frame number/total number of frames	11	Image quality (☞ 118, 144)
3	Upload marking (☞ 425)	12	Image size (☞ 120, 145)
4	Protect status (☞ 421)	13	Image area (☞ 136)
5	Retouch indicator (☞ 958)	14	File name (☞ 760)
6	Camera name	15	Time of recording (☞ 43)
7	Location data indicator (☞ 384)	16	Folder name (☞ 755)
8	Image comment indicator (☞ 911)	17	Date of recording (☞ 43)
9	IPTC preset indicator (☞ 400, 914)	18	Current card slot (☞ 38)
		19	Rating (☞ 423)

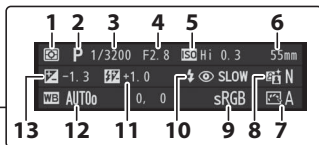
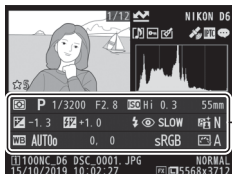

- 1** Metering (☞ 111, 178)
- 2** Exposure mode (☞ 108, 182)
- 3** Shutter speed (☞ 185, 188)
- 4** Aperture (☞ 186, 188)
- 5** ISO sensitivity <sup>1</sup> (☞ 114, 213)
- 6** Focal length
- 7** Picture Control (☞ 125, 271)
- 8** Active D-Lighting (☞ 281)
- 9** Color space (☞ 765)

- 10** Flash mode <sup>2</sup> (☞ 131, 648)
- 11** Flash compensation <sup>2</sup> (☞ 133, 653)  
Commander mode <sup>2</sup>
- 12** White balance (☞ 121, 221)  
Color temperature (☞ 231)  
Preset manual (☞ 234)  
White balance fine-tuning (☞ 227)
- 13** Exposure compensation (☞ 117, 199)



- 1** Displayed in red if photo was taken in mode **P**, **S**, or **A** with auto ISO sensitivity control on.
- 2** Displayed only if photo was taken with optional flash unit.

## Playback Zoom

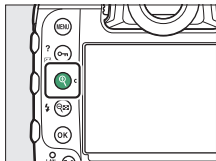
To zoom in on a photo displayed in full-frame playback, press the  button or the center of the multi selector or give the display two quick taps. [FX (36×24)]-format photos can be zoomed in to maximum of approximately 21× (**Large** pictures), 16× (**Medium**), or 10× (**Small**). Faces detected during zoom are indicated by white borders; rotate the sub-command dial to view other faces.



## Using Playback Zoom

Operation	Description
<b>Zoom in or out</b>	<ul style="list-style-type: none"><li>• Press the  button or use stretch gestures to zoom in.</li><li>• To zoom out, press  or use pinch gestures.</li></ul>  <p>A navigation window is displayed when the zoom ratio is altered, with the area currently visible indicated by a yellow border. A bar below the navigation window shows the zoom ratio, turning green at 1:1. The navigation window clears from the display after a few seconds.</p>
<b>View other areas of image</b>	Use the multi selector or glide gestures to view areas of image not visible in the monitor. Keep the multi selector pressed to scroll rapidly to other areas of frame.

Operation	Description
<b>Crop picture</b> *	To crop the picture to the area currently visible in the monitor, press <b>i</b> and select <b>[Quick crop]</b> .
<b>Select faces</b>	<p data-bbox="298 179 609 397">Faces detected during zoom are indicated by white borders in the navigation window. Rotate the sub-command dial or tap the on-screen guide to view other faces.</p> 
<b>View other pictures</b>	Rotate the main command dial to view the same location in other photos without changing the zoom ratio (selecting a movie cancels zoom). You can also view other photos by tapping the ◀ or ▶ icon at the bottom of the display.
<b>Protect pictures</b>	Press the <b>On</b> ( <b>[P]</b> / <b>[?]</b> ) button to toggle protection for the current picture on or off (☐ 421).
<b>Resume shooting</b>	Press the shutter-release button halfway or press the <b>[▶]</b> button to exit to shooting mode.
<b>View menus</b>	Press the <b>MENU</b> button to view the menus.

\* **[Quick crop]** is not available in the **i** menu when RGB histograms are displayed (☐ 408).



## Protecting Pictures from Deletion

Pictures can be protected to prevent their being deleted accidentally. Protected pictures will however be deleted when the memory card is formatted (📖 887).

---



### 1 Select a picture.

- Display the picture in full-frame playback or playback zoom.
- Alternatively, you can highlight the picture in the thumbnail list using the multi selector.

---

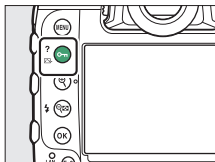
### 2 Press the button.



- Protected pictures are marked with a  icon.
- To remove protection, display the picture or highlight it in the thumbnail list and press  (/?) again.

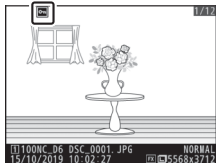





---

### **Voice Memos**

Protecting photos also protects any voice memos recorded with the pictures. Voice memos cannot be protected separately.

### **Removing Protection from All Images**

To remove protection from all images in the folder or folders currently selected for **[Playback folder]** in the playback menu, press the  (/?) and  () buttons for about two seconds during playback.

---

# Rating Pictures

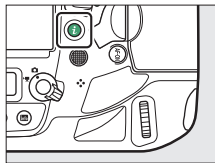

- 1 Select the desired picture with the multi selector and press the *i* button.**

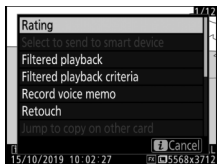

- 2 Highlight [Rating] and press .**



- 3 Choose a rating.**

Rotate the main command dial to choose the desired rating and then press . Choose from ratings of from zero to five stars, or select  to mark the picture as a candidate for later deletion.



---

## Ratings

Ratings can also be viewed in ViewNX-i and Capture NX-D. Protected pictures cannot be rated.

## Rating Pictures Using Camera Controls

If **[Rating]** is assigned to **[Fn button for vertical shooting]** or **[Fn3 button]** using Custom Setting f3 **[Custom controls]**, pictures can be rated by holding the selected control and rotating the main command dial.

---

## Selecting Pictures for Upload



Follow the steps below to select the current picture for upload to a smart device, computer, or ftp server.

- The **i** menu items used to select pictures for upload vary with the type of device connected:
  - [**Select to send to smart device**]: Displayed when the camera is connected to a smart device via built-in Bluetooth using [**Connect to smart device**] in the setup menu (☞ 929).
  - [**Select to send to computer**]: Displayed when the camera is connected to a computer via built-in Wi-Fi using [**Connect to PC (built-in Wi-Fi)**] in the setup menu (☞ 932).
  - [**Select to send (wired LAN/WT)**]: Displayed when the camera is connected to a computer or ftp server via Ethernet or an optional WT-6 wireless transmitter using [**Wired LAN/WT**] in the setup menu (☞ 937).
- Movies cannot be selected for upload when the camera is connected to a smart device via the SnapBridge app.
- The maximum file size for movies uploaded by other means is 4 GB.

---

**1 Select the desired picture and press the *i* button.**

**2 Highlight [Select to send to smart device], [Select to send to computer], or [Select to send (wired LAN/WT)] and press **OK**.**

Pictures destined for a smart device are marked with a  icon, while those destined for a computer or ftp server are marked with .

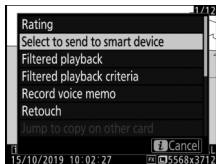

---

**✓ Removing Upload Marking**

To remove upload marking, repeat Steps 1 and 2.

---

## Filtered Playback

Select [**Filtered playback**] in the **i** menu to view only pictures that meet the criteria chosen for [**Filtered playback criteria**] in the playback menu or playback **i** menu.

### [Filtered Playback Criteria]

Highlight options and press  to select () or deselect (). During filtered playback, only pictures that meet all criteria marked with a check () will be displayed.

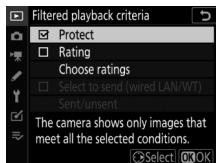

Option	Description
[Protect]	<input checked="" type="checkbox"/> : Include protected pictures.
[Rating]	<input checked="" type="checkbox"/> : Include pictures with selected ratings.
[Select to send (wired LAN/WT)]	<ul style="list-style-type: none"> <li>• Select <input checked="" type="checkbox"/> [Sent images] to include pictures previously uploaded to a computer or ftp server via Ethernet or an optional WT-6 wireless transmitter.</li> <li>• Select <input checked="" type="checkbox"/> [Unsent images] to include pictures that have yet to be uploaded.</li> <li>• Select both options to include both sent and unsent pictures.</li> </ul>

- During filtered playback, a white border appears around the display.
- To end filtered playback, select [Filtered playback] again.







## Deleting Pictures

Follow the steps below to delete pictures from memory cards. Note that pictures cannot be recovered once deleted. Pictures that are protected or hidden, however, cannot be deleted.

### Using the Delete Button

Press the  (FORMAT) button to delete the current picture.

**1 Select the desired picture with the multi selector and press the  (FORMAT) button.**

- A confirmation dialog will be displayed.
- To exit without deleting the picture, press .

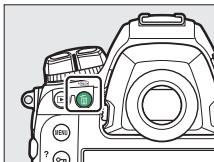

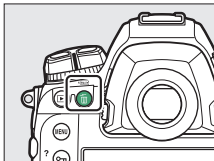

**2 Press the  (FORMAT) button again.**

The picture will be deleted.



---





## **Deleting Copies**

If the picture selected for playback when the  (FORMAT) button is pressed was recorded with two memory cards inserted and an option other than **[Overflow]** selected for **[Role played by card in Slot 2]** in the photo shooting menu, you will be given the option of deleting both copies or only the copy on the card in the current slot ( 311).

---

## Deleting Multiple Pictures

Use **[Delete]** in the playback menu to delete multiple pictures at once. Note that depending on the number of images, some time may be required for deletion.

	Option	Description
	<b>[Selected images]</b>	Delete selected pictures.
	<b>[Candidates for deletion]</b>	Delete pictures rated  (candidate for deletion).
	<b>[Images shot on selected dates]</b>	Delete all pictures taken on selected dates (  434).
ALL	<b>[All images]</b>	Delete all pictures from a selected memory card. Only pictures in the folder currently selected for <b>[Playback folder]</b> in the playback menu are affected.

## ■ Deleting Selected Pictures



### 1 Select pictures.

- Highlight pictures using the multi selector and press the center to select; selected pictures are marked with  icons. Selected pictures can be deselected by pressing the center of the multi selector again.



- Repeat until all the desired pictures are selected.
- To view the highlighted picture full screen, press and hold the  button.

### 2 Delete the pictures.



- Press ; a confirmation dialog will be displayed.
- Highlight **[Yes]** and press  to delete the selected pictures.





## ■ Candidates for Deletion

---

### 1 Select pictures.



- The camera will list all pictures rated  (candidate for deletion). Pictures you do not currently wish to delete can be deselected by highlighting them and pressing the center of the multi selector.
- To view the highlighted picture full screen, press and hold the  button.

### 2 Delete the pictures.

- Press ; a confirmation dialog will be displayed.
- Highlight [Yes] and press  to delete the selected pictures.



## ■ Images Shot on Selected Dates

### 1 Select dates.

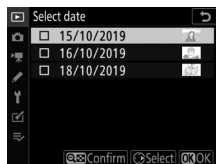
- Highlight dates using the multi selector and press  to select; selected dates are marked with  icons. Selected dates can be deselected by pressing  again.
- Repeat until you have selected all the desired dates.



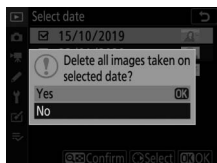

### 2 Delete the pictures.

- Press ; a confirmation dialog will be displayed.
- Highlight [Yes] and press  to delete all the pictures taken on the selected dates.



## ■ Deleting All Pictures

### 1 Choose a memory card.

Press  or  to highlight the slot containing the memory card from which the pictures will be deleted and press .

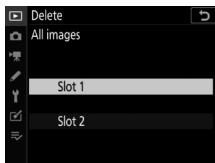

### 2 Delete the pictures.

- Highlight **[Yes]** and press  to delete all pictures in the folder currently selected for **[Playback folder]** in the playback menu.
- Note that depending on the number of images, some time may be required for deletion.



# Voice Memos



## Recording Voice Memos

Voice memos up to 60 seconds long can be added to photographs.

### During Playback

To add voice memos to selected pictures during playback:

#### **1** Select the photograph.

Only one voice memo can be recorded per picture; additional voice memos cannot be recorded for pictures already marked with a  icon. The existing voice memo must be deleted before another can be recorded ( 444).





---

## 2 Hold the Fn3 (🎤) button.

- Recording starts when the button is pressed and ends when it is released.
- A 🎤 icon is displayed while recording is in progress.

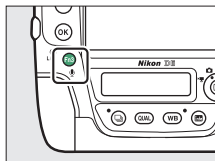

---

## 3 Release the Fn3 (🎤) button.

Recording will end.

---

### 📝 During Recording

During recording, a flashing 🎤 icon and a countdown timer showing the recording time remaining will be displayed in the rear control panel.



---

### 📝 The *i* Menu

Recording can also be initiated by highlighting [**Record voice memo**] in the playback *i* menu and pressing . To end recording, press the center of the multi selector.

## During Shooting

A voice memo can be recorded with the most recent photograph during shooting. Recording can be initiated automatically or manually.

### ■ Automatic Recording

If [**On (Auto and manual)**] is selected for [**Voice memo options**] > [**Voice memo**] in the setup menu, recording will begin automatically when you lift your finger from the shutter-release button after shooting.

- The recording time can be selected using [**On (Auto and manual)**].

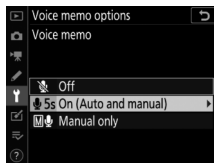

---

### ✔ **Image Review**

Automatic recording is not available when **[On]** is selected for **[Image review]** in the playback menu.

### ✔ **Automatic Recording**

Voice memos will not be recorded automatically during:

- live view,
  - focus shift, or
  - time-lapse movie recording
-

## Manual Recording

Voice memos can be manually added to the most recent photograph.

- Before proceeding, select [**Manual only**] for [**Voice memo options**] > [**Voice memo**] in the setup menu.

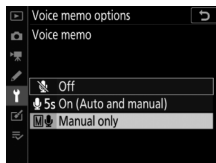

- To record a voice memo, hold the **Fn3** (🎤) button; recording will continue while the button is pressed.

---

### Voice Memo

An icon is displayed in the rear control panel when [**On (Auto and manual)**] or [**Manual only**] is selected for [**Voice memo**].

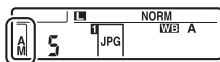

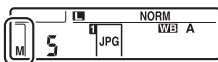

On (Auto and manual)



Manual only

## After Recording

If a voice memo has been recorded for the most recent photograph, a  icon will be displayed in the rear control panel.

During playback, the presence of a voice memo is indicated by a  icon.

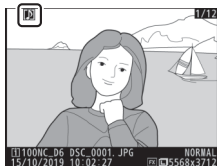
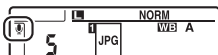

## Interrupting Recording

Pressing the shutter-release button or operating other camera controls may end recording. During interval-timer photography, recording ends about two seconds before the next shot is taken; recording also ends when the camera is turned off.

## Storage Location

Voice memos for pictures taken with two memory cards inserted and **[Backup]**, **[RAW Slot 1 - JPEG Slot 2]**, or **[JPEG Slot 1 - JPEG Slot 2]** selected for **[Role played by card in Slot 2]** in the photo shooting menu are recorded with the copies on both cards. This applies whether the voice memo is recorded from the  menu or manually after shooting.

## **Voice Memo File Names**

Voice memo file names have the form “DSC\_nnnn.WAV”. The voice memo has the same file number (“nnnn”) as the picture with which it is associated. For example, the voice memo for the image “DSC\_0002.JPG” would have the file name “DSC\_0002.WAV.” Voice memo file names can be viewed on a computer.

- Voice memos for photos recorded with [**Adobe RGB**] selected for [**Color space**] in the photo shooting menu have names of the form “\_DSCnnnn.WAV”.
  - Voice memos for photos recorded with a prefix other than [**DSC**] selected for [**File naming**] in the photo shooting menu will be recorded with the selected prefix in place of [**DSC**].
-

## Playing Voice Memos

To play voice memos, press the **Fn3** (🗣️) button when viewing photographs marked with 🗣️ icons.



---

### 📝 The *i* Menu

Voice memos can also be played by highlighting [**Play voice memo**] in the playback *i* menu and pressing **OK**.





### 📝 Interrupting Playback

Pressing the shutter-release button or operating other camera controls may end playback. Playback ends automatically when another image is selected or the camera is turned off.

---

## Deleting Voice Memos

To delete the voice memo from the current photo, press the  (FORMAT) button; a confirmation dialog will be displayed as shown.

- To delete both the photo and the voice memo, highlight [**Image and voice memo**] and press  (FORMAT).
- To delete only the voice memo, highlight [**Voice memo only**] and press  (FORMAT).
- To exit without deleting either the photo or the voice memo, press .
- If the photo was shot with two memory cards inserted and [**Backup**], [**RAW Slot 1 - JPEG Slot 2**], or [**JPEG Slot 1 - JPEG Slot 2**] selected for [**Role played by card in Slot 2**], highlight either [**Selected image**] or [**Same images on [1] and [2]**] and press  (FORMAT) to display a confirmation dialog. To delete only the voice memo from the picture on the card in the current slot, select [**Voice memo only**] after choosing [**Selected image**].





# Connecting to Computers and TVs

## Connecting to Computers

Establish a connection to a computer to upload pictures from the camera. The camera can be connected via Wi-Fi or using a USB cable.

### **Connecting via USB**

Connect the camera using the supplied USB cable. You can then use Nikon ViewNX-i software to copy pictures to the computer for viewing and editing.

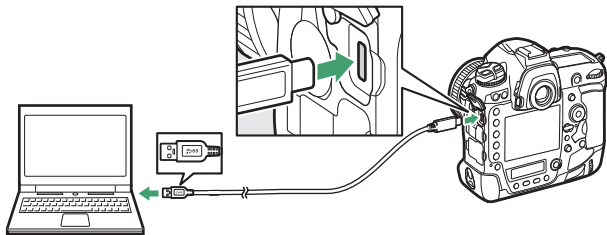

## ■ Installing ViewNX-i

You will need an Internet connection when installing ViewNX-i. Visit the Nikon website for system requirements and other information.

- Download the latest ViewNX-i installer from the website below and follow the on-screen instructions to complete installation.

<https://downloadcenter.nikonimglib.com/>

- Note that you may be unable to download pictures from the camera using earlier versions of ViewNX-i.

---

## ✓ Capture NX-D

Use Nikon's Capture NX-D software to fine-tune photos or to change settings for NEF (RAW) pictures and save them in other formats.

Capture NX-D is available for download from:

<https://downloadcenter.nikonimglib.com/>

---

## ■ Copying Pictures to a Computer Using ViewNX-i

See online help for detailed instructions.

---

### 1 Connect the camera to the computer.

After turning the camera off and ensuring that a memory card is inserted, connect the supplied USB cable as shown.

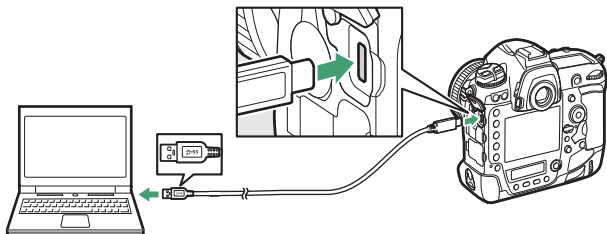

---

### 2 Turn the camera on.

- The Nikon Transfer 2 component of ViewNX-i will start.
- If a message is displayed prompting you to choose a program, select Nikon Transfer 2.
- If Nikon Transfer 2 does not start automatically, launch ViewNX-i and click the "Import" icon.

### 3 Click [Start Transfer].

Pictures on the memory card will be copied to the computer.

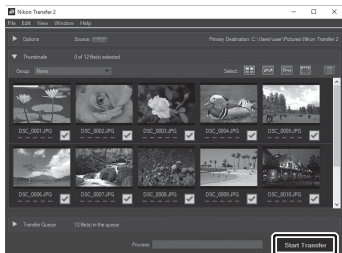

### 4 Turn the camera off.

Disconnect the USB cable when transfer is complete.

## ✔ Windows 10 and Windows 8.1

Windows 10 and Windows 8.1 may display an AutoPlay prompt when the camera is connected.

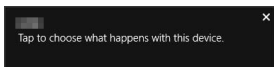

Click the dialog and then click **[Nikon Transfer 2]** to select Nikon Transfer 2.

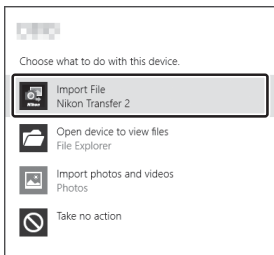

## ✔ macOS

If Nikon Transfer 2 does not start automatically, confirm that the camera is connected and then launch Image Capture (an application that comes with macOS) and select Nikon Transfer 2 as the application that opens when the camera is detected.

## ✔ Transferring Movies

Do not attempt to transfer movies from the memory card while it is inserted in a camera of a different make or model. Doing so could result in the movies being deleted without being transferred.

### ✔ **Connecting to Computers**

- Do not turn the camera off or disconnect the USB cable while transfer is in progress.
- Do not use force or attempt to insert the connectors at an angle. Be sure also to keep the connectors straight when disconnecting the cable.
- Turn the camera off before connecting or disconnecting interface cables.
- To ensure that data transfer is not interrupted, be sure the camera battery is fully charged.

### ✔ **USB Hubs**

Connect the camera directly to the computer; do not connect the cable via a USB hub or keyboard.

---

## **Ethernet and Wireless Networks (Wi-Fi)**

For more information, see “Built-in Wireless” (📖 457) and “Ethernet/WT-6” (📖 514).

### **■ Built-in Wi-Fi**

Connect using the [**Connect to PC (built-in Wi-Fi)**] item in the camera setup menu. You can connect either directly or via a wireless router.



Connection via a wireless router



Direct wireless connection

## ■ The WT-6 Wireless Transmitter

With an optional WT-6 wireless transmitter, the camera can connect to computers or ftp servers using the **[Wired LAN/WT]** item in the setup menu. Use Camera Control Pro 2 (available separately) to control the camera and save pictures to the computer. The connection is more reliable than that offered by the camera's built-in Wi-Fi.



## ■ Ethernet Connections

With a third-party Ethernet cable, the camera can connect to computers or ftp servers using **[Wired LAN/WT]**. Use Camera Control Pro 2 (available separately) to control the camera and save pictures to the computer.





## Connecting to HDMI Devices

The camera can be connected to TVs, recorders, and other devices featuring HDMI connectors. Use the optional HDMI cable (☞ 1060) or a third-party type C HDMI cable. These items must be purchased separately. Always turn the camera off before connecting or disconnecting an HDMI cable.

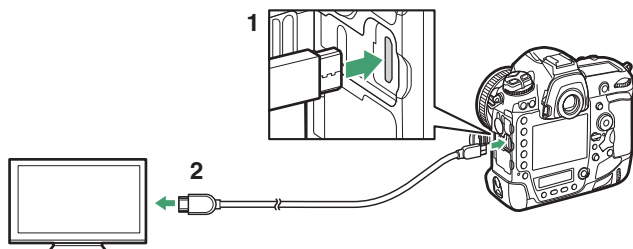

**1** HDMI connector for connection to camera

**2** HDMI connector for connection to external device \*

\* Choose a cable with a connector that matches the connector on the HDMI device.

## TVs

- After tuning the TV to the HDMI input channel, turn the camera on and press the  button to view pictures on the television screen.
- Audio playback volume can be adjusted using the controls on the TV. Camera controls cannot be used.
- If the camera is paired with a smart device running the SnapBridge app, the device can be used to control playback remotely while the camera is connected to a TV. See the SnapBridge app online help for details.

## Recorders

The camera can record video directly to connected HDMI recorders. Use the [HDMI] item in the setup menu to adjust settings for HDMI output. Some recorders will start and stop recording in response to camera controls.

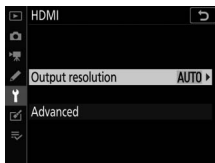



### ■ Output Resolution

Choose the format for images output to the HDMI device. If [Auto] is selected, the camera will automatically choose the appropriate format.

## ■ ■ Advanced

Adjust settings for connection to the HDMI device.

Option	Description
<b>[Output range]</b>	<p>The RGB video signal input range varies with the HDMI device. <b>[Auto]</b>, which matches the output range to the HDMI device, is recommended in most situations. If the camera is unable to determine the correct RGB video signal output range for the HDMI device, you can choose from the following options:</p> <ul style="list-style-type: none"><li>• <b>[Limited range]</b>: For devices with an RGB video signal input range of 16 to 235. Choose this option if you notice a loss of detail in shadows.</li><li>• <b>[Full range]</b>: For devices with an RGB video signal input range of 0 to 255. Choose this option if you notice that shadows are “washed out” or too bright.</li></ul>
<b>[Live view on-screen display]</b>	<p>Choose whether the HDMI device displays shooting information during live view photography. Note that shooting information will not be displayed at a frame size of 3840 × 2160 (□ 294) even when <b>[On]</b> is selected.</p>
<b>[Dual monitor]</b>	<p>Choose whether the camera mirrors the display on the HDMI device. Choosing <b>[Off (HDMI only)]</b> turns the camera monitor off, reducing the drain on the battery.</p> <ul style="list-style-type: none"><li>• Selecting <b>[Off]</b> for <b>[Live view on-screen display]</b> fixes <b>[Dual monitor]</b> at <b>[On]</b>.</li></ul>

Option	Description
<p>[External recording control]</p>	<p>Choosing <b>[On]</b> allows camera controls to be used to start and stop recording when the camera is connected via HDMI to a third-party recorder that supports the Atomos Open Protocol.</p> <ul style="list-style-type: none"> <li>• External recording control is available with Atomos SHOGUN, NINJA, and SUMO-series Monitor recorders. For more information on device features and operation, contact the manufacturer or refer to the documentation provided with the recorder.</li> <li>• The camera display will turn off automatically when the time selected for Custom Setting c2 <b>[Standby timer]</b> expires, ending HDMI output. When recording movies to an external device, select Custom Setting c2 <b>[Standby timer]</b> and choose <b>[No limit]</b> or a time longer than the anticipated recording time.</li> <li>• An icon will be displayed in the camera monitor when <b>[On]</b> is selected:  <b>STBY</b> is displayed during filming,  <b>REC</b> while movies are being recorded. During recording, check the recorder and recorder display to ensure that footage is being saved to the device.</li> <li>• Note that selecting <b>[On]</b> may disrupt the footage output to the device.</li> </ul>

# Built-in Wireless

## Camera and Network System Chart

This section is chiefly devoted to describing how to connect to a wireless local area network (LAN) using the camera's built-in Wi-Fi or Bluetooth and how to use network features once connected.

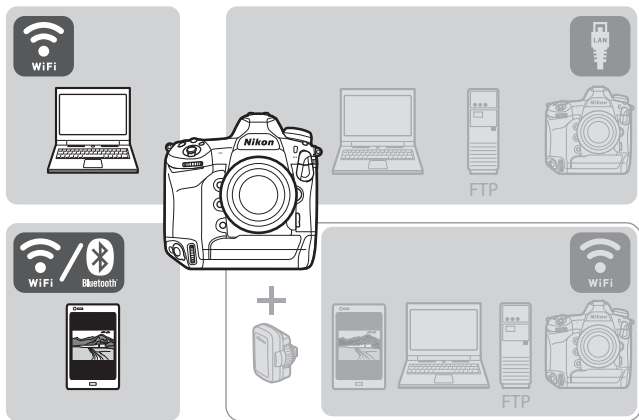

- For information on connecting to Ethernet networks or connecting using an optional WT-6 wireless transmitter, see “Ethernet/WT-6” (📖 514).

## Connecting to Smart Devices

### The SnapBridge App

Use the SnapBridge app for wireless connections between the camera and your smartphone or tablet (“smart device”).



- The SnapBridge app is available from the Apple App Store® and on Google Play™.



- Visit the Nikon website for the latest SnapBridge news.

## **What SnapBridge Can Do for You**

The tasks that can be performed using the SnapBridge app are outlined below. For details, see the SnapBridge app online help: <https://nikonimglib.com/snbr/onlinehelp/en/index.html>

### **■ ■ Downloading Pictures from the Camera**

Download existing pictures to your smart device. You also have the option of downloading pictures automatically as they are taken.

### **■ ■ Remote Photography**

Control the camera and take pictures from the smart device.

## Wireless Connections

Use the SnapBridge app for wireless connections between the camera and your smart device. You can connect via either Wi-Fi (📖 461) or Bluetooth (📖 469). Connecting using the SnapBridge app allows you to set the camera clock and update location data using information provided by the smart device. Connecting using Bluetooth allows pictures to be uploaded automatically as they are taken.

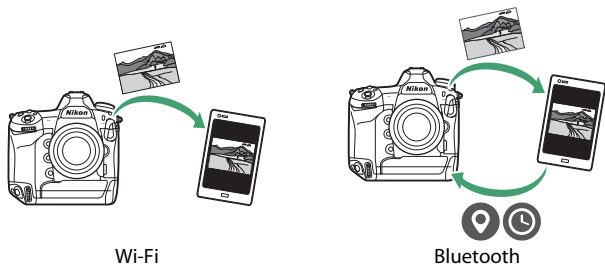



## Connecting via Wi-Fi (Wi-Fi Mode)

### ✔ Before Connecting

- Enable Wi-Fi on the smart device. For details, see the documentation provided with the device.
- Ensure that the batteries in the camera and smart device are fully charged to prevent the devices turning off unexpectedly.
- Check that there is space available on the camera memory card.

## 1 Smart device: Launch the SnapBridge app.

If this is the first time you have launched the app, tap **[Skip]**. If you have launched the app before, you can instead proceed to Step 2.



---

## 2 Open the tab and tap > [Wi-Fi mode].

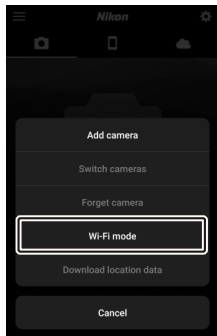
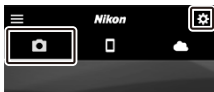

---

## 3 Smart device: Tap [Wi-Fi connection] when prompted.

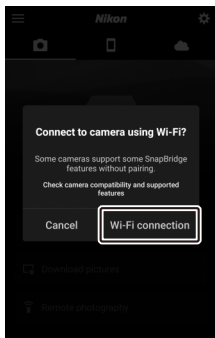

## 4 Camera/smart device: Turn the camera on when prompted to do so by the smart device.

Do not tap **[Next]** until you have completed the next step.

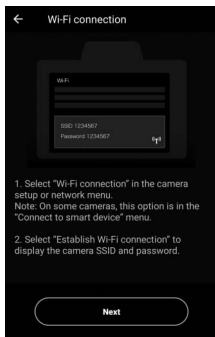

## 5 Camera: Select [Connect to smart device] > [Wi-Fi connection] in the setup menu, then highlight [Establish Wi-Fi connection] and press **OK**.

The camera SSID and password will be displayed.



## 6 Smart device: Return to the smart device and tap [Next].

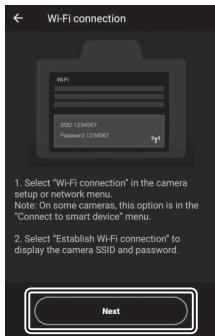

## 7 Smart device: After reading the instructions displayed by the smart device, tap [Open the device settings app].

- Android devices: Wi-Fi settings will be displayed.

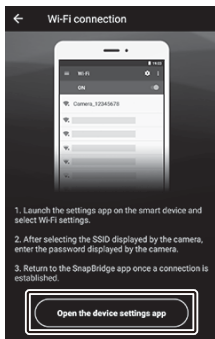

- iOS devices: The “Settings” app will launch. Tap [**< Settings**] to open [**Settings**], then scroll up and tap [**Wi-Fi**], which you’ll find near the top of the settings list.

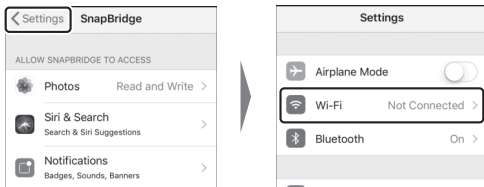

## 8 Smart device: Enter the SSID and password displayed by the camera in Step 5.

- The prompt displayed by the device varies with model and operating system.

### - Android device

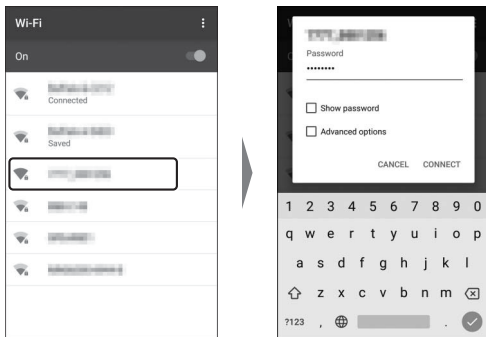

## - iOS device

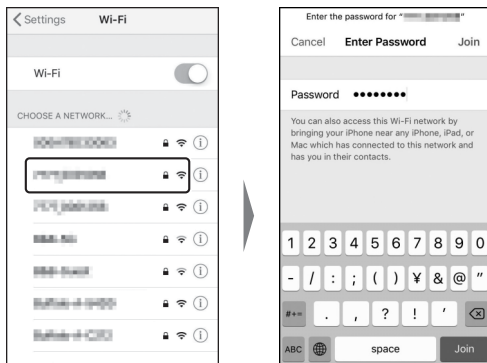



- You will not be required to enter the password when next you connect to the camera.

## 9 Smart device: Return to the SnapBridge app.

- Once a Wi-Fi connection is established, Wi-Fi mode options will be displayed.
- See online help for information on using the SnapBridge app.



### ✓ Terminating Wi-Fi Mode

To end the Wi-Fi connection, tap . When the icon changes to , tap  and select [Exit Wi-Fi mode.].





## **Connecting via Bluetooth**

Before connecting via Bluetooth for the first time, you will need to pair the camera and smart device as described below. The procedure for iOS differs slightly from that for Android devices.

---

### **✔ Before Pairing**

- Enable Bluetooth on the smart device. For details, see the documentation provided with the device.
  - Ensure that the batteries in the camera and smart device are fully charged to prevent the devices turning off unexpectedly.
  - Check that there is space available on the camera memory card.
-

## ■ Connecting to an Android Device for the First Time: Pairing

For information on connecting to iOS devices, see “Connecting to an iOS Device for the First Time: Pairing” (📖 476).

- 1 Camera: Select [Connect to smart device] > [Pairing (Bluetooth)] in the setup menu, then highlight [Start pairing] and press .**

The camera name will be displayed in the monitor.

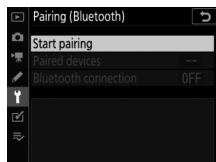

## 2 Android device: Launch the SnapBridge app.

- If this is the first time you have launched the app, tap [**Connect to camera**].



- If you have launched the app before, open the  tab and tap [**Connect to camera**].

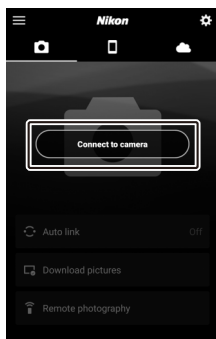

### 3 Android device: Tap the camera name.

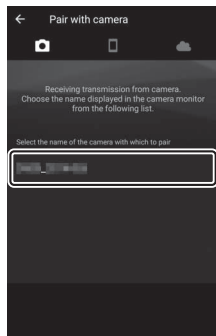

### 4 Camera/Android device: Confirm that the camera and Android device display the same authentication code.

The authentication code is shown circled in the illustrations.

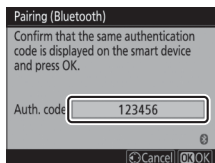
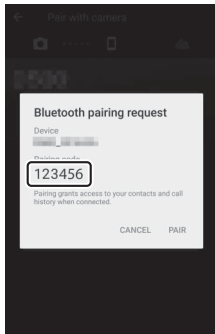

---

## 5 Camera/Android device: Initiate pairing.

- **Camera:** Press **OK**.

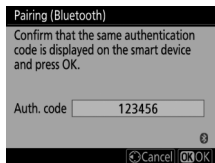

- **Android device:** Tap the button indicated in the illustration. The button in the illustration is labeled **[PAIR]**, but the label may differ depending on the type of device and version of Android you are using.

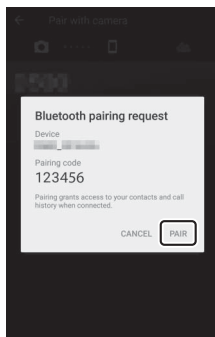

---

### ✔ Pairing Error

If you wait too long between pressing the button on the camera and tapping the button on the Android device, the device will display an error message and pairing will fail. Tap **[OK]** and return to Step 2.

---

## 6 Camera/Android device: Follow the on-screen instructions to complete pairing.

- **Camera:** The camera will display the message shown in the illustration when pairing is complete.

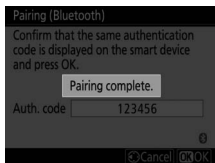

- **Android device:** Pairing is complete. Tap [OK] to exit to the  tab.

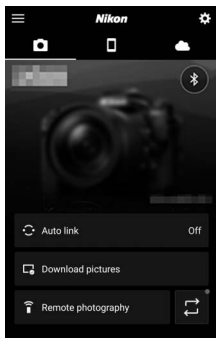
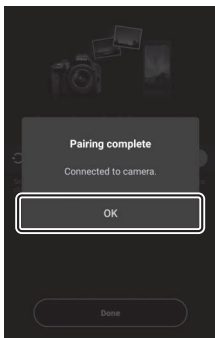

---

### ✔ **Pairing for the First Time**

- The first time you pair the Android device with a camera after installing the SnapBridge app, you will be prompted to select auto link (auto upload and auto clock and location synchronization) options.
- This prompt will not be displayed a second time. Auto link settings can however be accessed at any time using [**Auto link**] in the  tab.

### ✔ **Disabling Bluetooth**

To disable Bluetooth, select [**Disable**] for [**Connect to smart device**] > [**Pairing (Bluetooth)**] > [**Bluetooth connection**] in the camera setup menu.

---

## ■ Connecting to an iOS Device for the First Time: Pairing

For information on connecting to Android devices, see “Connecting to an Android Device for the First Time: Pairing” (📖 470).

- 1 Camera: Select [Connect to smart device] > [Pairing (Bluetooth)] in the setup menu, then highlight [Start pairing] and press **OK**.**

The camera name will be displayed in the monitor.

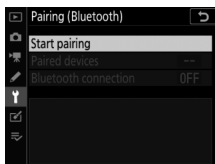



## 2 iOS device: Launch the SnapBridge app.

- If this is the first time you have launched the app, tap [**Connect to camera**].



- If you have launched the app before, open the  tab and tap [**Connect**].

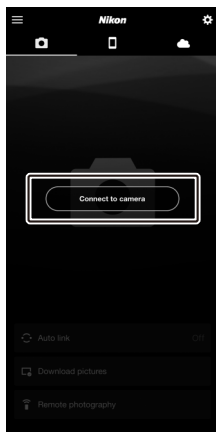

### 3 iOS device: Tap the camera name.

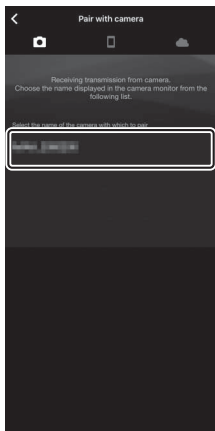

### 4 iOS device: Read the pairing instructions.

Pairing instructions will be displayed. Read the instructions carefully and tap **[Understood]**.

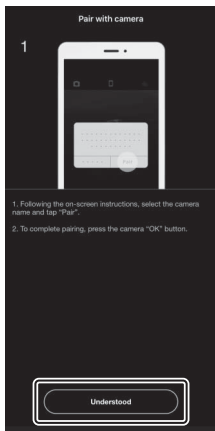

---

## 5 iOS device: Tap the camera name again.

The iOS device prompt you to select an accessory. Tap the camera name again.

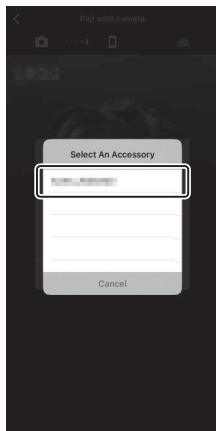

## 6 Camera/iOS device: Initiate pairing.

- **Camera:** Press .

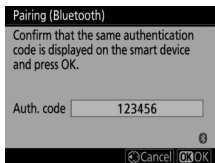

- **iOS device:** Tap the button indicated in the illustration. The button in the illustration is labeled **[Pair]**, but the label may differ depending on the version of iOS you are using.

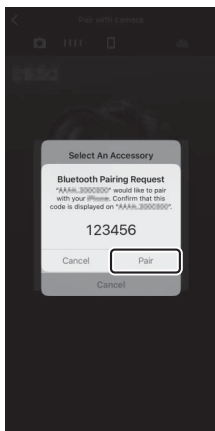

## ✔ Pairing Error

If you wait too long between pressing the button on the camera and tapping the button on the iOS device, the device will display an error message and pairing will fail. Dismiss the SnapBridge app and check that it is not running in the background, then open the iOS “Settings” app and request iOS to “forget” the camera before returning to Step 1. “Forget” the camera using the iOS “Settings” app.

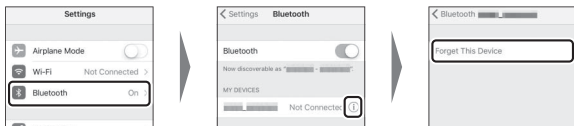

## 7 Camera/iOS device: Follow the on-screen instructions to complete pairing.

- **Camera:** The camera will display the message shown in the illustration when pairing is complete.

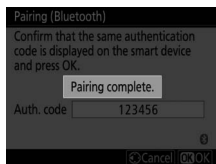

- **iOS device:** Pairing is complete. Tap [OK] to exit to the  tab.

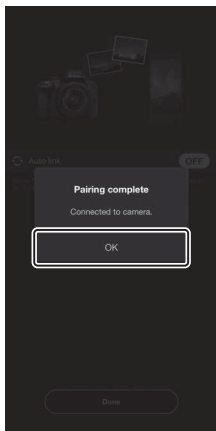

---

### ✔ **Pairing for the First Time**

- The first time you pair the iOS device with a camera after installing the SnapBridge app, you will be prompted to select auto link (auto upload and auto clock and location synchronization) options.
- This prompt will not be displayed a second time. Auto link settings can however be accessed at any time using [**Auto link**] in the  tab.

### ✔ **Disabling Bluetooth**

To disable Bluetooth, select [**Disable**] for [**Connect to smart device**] > [**Pairing (Bluetooth)**] > [**Bluetooth connection**] in the camera setup menu.

---

## ■ Connecting to a Paired Device

Connecting to a smart device that has already been paired with the camera is quick and easy.

- 1 Camera:** In the setup menu, select [Connect to smart device] > [Pairing (Bluetooth)] > [Bluetooth connection], then highlight [Enable] and press **OK**.

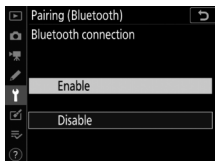

- 2 Smart device:** Launch the SnapBridge app.

A Bluetooth connection will be established automatically.

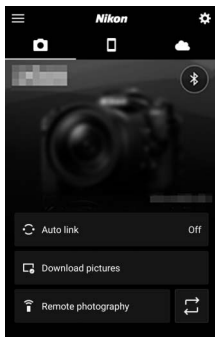



## Connecting to Computers via Wi-Fi

### What Wi-Fi Can Do for You

Connect using the camera's built-in Wi-Fi to upload selected pictures to a computer.

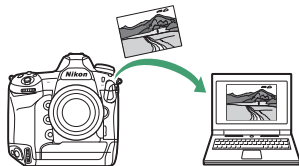

### The Wireless Transmitter Utility

Before you will be able to upload images via Wi-Fi, you will need to pair the camera with the computer using Nikon's Wireless Transmitter Utility software.

- Once the devices are paired, you will be able to connect to the computer from the camera.
- The Wireless Transmitter Utility is available for download from the Nikon Download Center. Be sure to download the latest version after reading the release notes and system requirements.

<https://downloadcenter.nikonimglib.com/>

## Infrastructure and Access-Point Modes

Either of the following two methods can be used to establish wireless connections between the camera and a computer.

### ■ Direct Wireless Connection (Access-Point Mode)

The camera and computer connect via direct wireless link.



The camera acts as a wireless LAN access point, eliminating the need for wireless LAN

infrastructure with its

complicated settings. The computer cannot connect to the Internet while connected to the camera.

- To create a new host profile, select [**Direct connection to PC**] in the connection wizard.

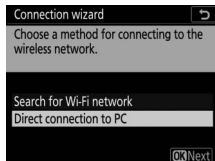

## ■ Infrastructure Mode

The camera connects to a computer on an existing network (including home networks) via a wireless router.



The computer can still connect to the Internet while connected to the camera.

- To create a new network profile, select **[Search for Wi-Fi network]** in the connection wizard.

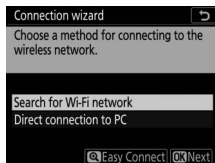

---

## ✓ Infrastructure Mode

- This guide assumes you are connecting via an existing wireless network.
  - Connection to computers beyond the local area network is not supported. You can connect only to computers on the same network.
-

## Connecting in Access-Point Mode

- 1 Select [Connect to PC (built-in Wi-Fi)] in the camera setup menu, then highlight [Network settings] and press .



- 2 Highlight [Create profile] and press .

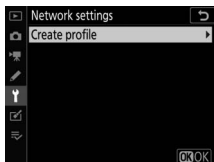

- 3 Highlight [Direct connection to PC] and press .

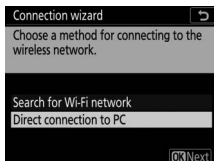

The camera SSID and encryption key will be displayed.

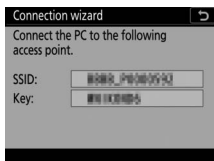

## 4 Establish a connection to the camera.

### Windows:

- Click the wireless LAN icon in the taskbar.
- Select the SSID displayed by the camera in Step 3.
- When prompted to enter the network security key, enter the encryption key displayed by the camera in Step 3. The computer will initiate a connection to the camera.

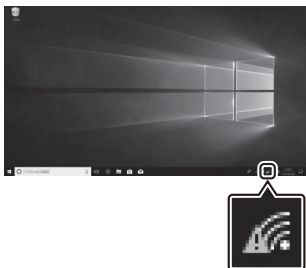

### macOS:

- Click the wireless LAN icon in the menu bar.
- Select the SSID displayed by the camera in Step 3.
- When prompted to enter the network security key, enter the encryption key displayed by the camera in Step 3. The computer will initiate a connection to the camera.

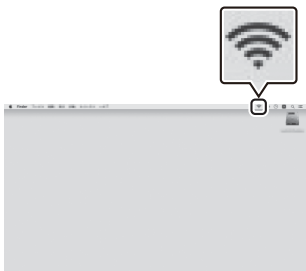

## 5 Start pairing.

When prompted, launch the Wireless Transmitter Utility on the computer.



## 6 Select the camera in the Wireless Transmitter Utility.

Select the name displayed by the camera in Step 5 and click [**Next>**].

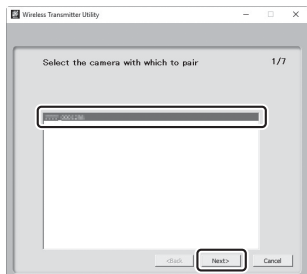

## 7 In the Wireless Transmitter Utility, enter the authentication code displayed by the camera.

- The camera will display an authentication code.
- Enter the authentication code in the dialog displayed by the Wireless Transmitter Utility and click **[Next>]**.

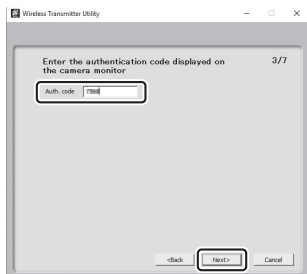

## 8 Complete the pairing process.

- When the camera displays a message stating that pairing is complete, press **OK**.
- In the Wireless Transmitter Utility, click **[Next>]**; you will be prompted to choose a destination folder. For more information, see online help for the Wireless Transmitter Utility.

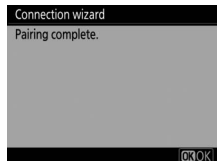

- A wireless connection will be established between the camera and computer when pairing is complete.



## 9 Check the connection.

When a connection is established, the network SSID will be displayed in green in the camera [Connect to PC (built-in Wi-Fi)] menu.

- If the camera SSID is not displayed in green, connect to the camera via the wireless network list on your computer.

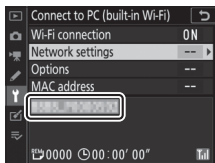

*A wireless connection has now been established between the camera and the computer.*

*Pictures taken with the camera can be uploaded to the computer as described in "Uploading Pictures" (📖 503).*

## Connecting in Infrastructure Mode

- 1 Select [Connect to PC (built-in Wi-Fi)] in the camera setup menu, then highlight [Network settings] and press .**



- 2 Highlight [Create profile] and press .**

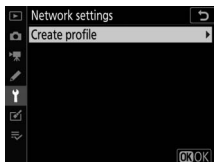

- 3 Highlight [Search for Wi-Fi network] and press .**

The camera will search for networks currently active in the vicinity and list them by name (SSID).

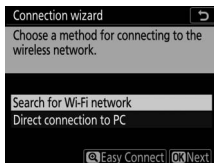

### ✓ [Easy Connect]

- To connect without entering an SSID or encryption key, press **Q** in Step 3. Next, press **OK** and choose from the following options:

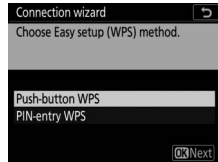

Option	Description
<b>[Push-button WPS]</b>	For routers that support push-button WPS. Press the WPS button on the router and then press the camera <b>OK</b> button to connect.
<b>[PIN-entry WPS]</b>	The camera will display a PIN. To connect, use a computer to enter the PIN on the router. For more information, see the documentation provided with the router.

- After connecting, proceed to Step 6.

## 4 Choose a network.

- Highlight a network SSID and press **OK**.
- Encrypted networks are indicated by a **lock** icon. If the selected network is encrypted (**lock**), you will be prompted to enter the encryption key. If the network is not encrypted, proceed to Step 6.
- If the desired network is not displayed, press **Search** to search again.

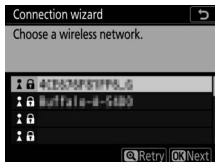

### ✓ Hidden SSIDs

Networks with hidden SSIDs are indicated by blank entries in the network list.

- To connect to a network with a hidden SSID, highlight a blank entry and press **OK**. Next, press the center of the multi-selector; you will then be prompted to provide an SSID.
- Enter the network name and press **OK**. Press **OK** again; the camera will now prompt you to enter the encryption key.

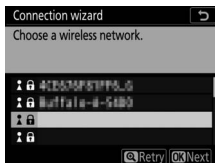

## 5 Enter the encryption key.

- Press the center of the multi selector and enter the encryption key for the wireless router.
- For more information, see the documentation for the wireless router.
- Press **OK** when entry is complete.
- Press **OK** again to initiate the connection. A message will be displayed for a few seconds when the connection is established.

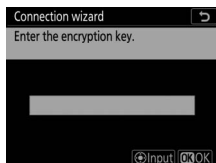

## 6 Obtain or select an IP address.

- Highlight one of the following options and press **OK**:

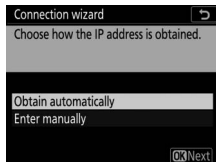

Option	Description
<b>[Obtain automatically]</b>	Select this option if the network is configured to supply the IP address automatically. A “configuration complete” message will be displayed once an IP address has been assigned.
<b>[Enter manually]</b>	Enter the IP address and sub-net mask manually. <ul style="list-style-type: none"><li>• Press the center of the multi selector to display a dialog where you can manually enter an IP address.</li><li>• Rotate the main command dial to highlight segments.</li><li>• Press <b>←</b> or <b>→</b> to change the highlighted segment and press the center of the multi selector when entry is complete.</li><li>• Next, press <b>OK</b>; a “configuration complete” message will be displayed. Press <b>OK</b> again to display the sub-net mask.</li><li>• Press <b>↑</b> or <b>↓</b> to edit the sub-net mask and press <b>OK</b>; a “configuration complete” message will be displayed.</li></ul>

- Press **OK** to proceed when the “configuration complete” message is displayed.

## 7 Start pairing.

When prompted, launch the Wireless Transmitter Utility on the computer.



## 8 Select the camera in the Wireless Transmitter Utility.

Select the name displayed by the camera in Step 7 and click [**Next>**].

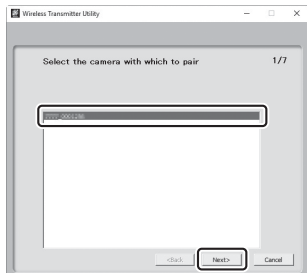

## 9 In the Wireless Transmitter Utility, enter the authentication code displayed by the camera.

- The camera will display an authentication code.
- Enter the authentication code in the dialog displayed by the Wireless Transmitter Utility and click **[Next>]**.

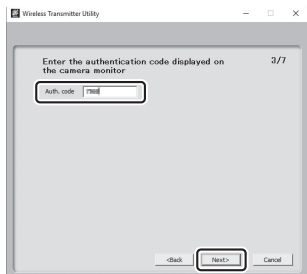



## 10 Complete the pairing process.

- When the camera displays a message stating that pairing is complete, press **OK**.
- In the Wireless Transmitter Utility, click **[Next>]**; you will be prompted to choose a destination folder. For more information, see online help for the Wireless Transmitter Utility.

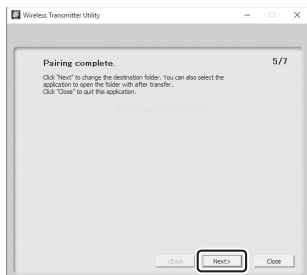
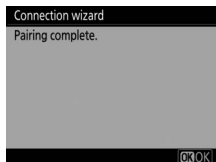

- A wireless connection will be established between the camera and computer when pairing is complete.

## 11 Check the connection.

When a connection is established, the network SSID will be displayed in green in the camera [ **Connect to PC (built-in Wi-Fi)** ] menu.

- If the camera SSID is not displayed in green, connect to the camera via the wireless network list on your computer.

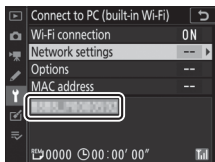

*A wireless connection has now been established between the camera and the computer.*

*Pictures taken with the camera can be uploaded to the computer as described in "Uploading Pictures" (📖 503).*

## **Uploading Pictures**

Pictures can be selected for upload during playback. They can also be uploaded automatically as they are taken.

---

### **✔ Destination Folders**

By default, images are uploaded to the following folders:

- Windows: \Users\*(user name)*\Pictures\Wireless Transmitter Utility
- macOS: /Users/*(user name)*/Pictures/Wireless Transmitter Utility

The destination folder can be selected using the Wireless Transmitter Utility. For more information, see the utility's online help.

### **✔ Access Point Mode**

Computers cannot access the Internet while connected to the camera in access point mode. To access the Internet, terminate the connection to the camera and then reconnect to a network with Internet access.

---

## ■ Selecting Pictures for Upload

**1** Press the  button on the camera and select full-frame or thumbnail playback.

**2** Select a picture and press the  button.

**3** Highlight [Select to send to computer] and press .

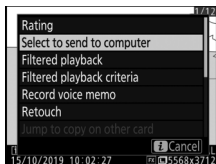

- A white “send” (priority upload) icon will appear on the picture. If the camera is currently connected to a network, upload will begin immediately.
- Otherwise, upload will begin when a connection is established.
- Repeat Steps 2–3 to upload additional pictures.



---

### ✓ Deselecting Pictures

- Repeat Steps 2–3 to remove transfer marking from selected images.
  - To remove transfer marking from all pictures, select [**Connect to PC (built-in Wi-Fi)**] > [**Options**] > [**Deselect all?**] in the setup menu.
-

## ■ ■ Uploading Photos as They Are Taken

To upload new photos as they are taken, select [On] for [Connect to PC (built-in Wi-Fi)] > [Options] > [Auto send] in the setup menu.

- Upload begins only after the photo has been recorded to the memory card. Be sure a memory card is inserted in the camera.
- Movies and photographs taken during filming are not uploaded automatically when recording is complete. They must instead be uploaded from the playback display.

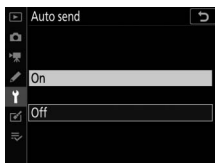

## ■ The Transfer Icon

Upload status is indicated by the transfer icon.

### (white): Send (priority upload)

The picture has been manually selected for upload. Pictures marked with this icon will be uploaded before pictures marked  (“send”).

### (white): Send

The picture has been selected for automatic upload but upload has not yet begun.

### (green): Sending

Upload in progress.

### (blue): Sent

Upload complete.

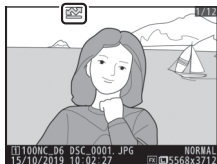

## ■ The [Connect to PC (Built-in Wi-Fi)] Status Display

The [Connect to PC (built-in Wi-Fi)] display shows the following:

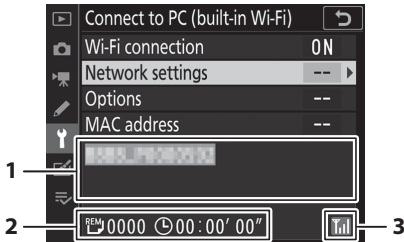

**1 Status:** The status of the connection to the host. The host SSID is displayed in green when a connection is established. While files are being transferred, the status display shows “Now sending” preceded by the name of the file being sent. Errors are also displayed here.

**2 Pictures/time remaining:** The number of pictures remaining and the time needed to send them. The time remaining is an estimate only.

**3 Signal strength:** Wireless signal strength.



---

### **✔ Loss of Signal**

Wireless transmission may be interrupted if the signal is lost. Upload of pictures with “send” marking can be resumed by turning the camera off and then on again once the signal has been re-established.

---

## Disconnecting and Reconnecting

### ■ Disconnecting

You can disconnect by:

- turning the camera off,
- selecting [**Disable**] for [**Connect to PC (built-in Wi-Fi)**] > [**Wi-Fi connection**] in the setup menu, or
- connecting to a smart device via Wi-Fi or Bluetooth.

---

### ✓ Access-Point Mode

An error will occur if the computer's wireless connection is disabled before the camera's. Disable camera Wi-Fi first.

---

## ■ Reconnecting

To reconnect to an existing network:

- select **[Enable]** for **[Connect to PC (built-in Wi-Fi)]** > **[Wi-Fi connection]** in the setup menu.
- 

### ✓ Access-Point Mode

Enable camera Wi-Fi before connecting.

### ✓ Multiple Network Profiles

If the camera has profiles for more than one network, it will reconnect to the last network used. Other networks can be selected using the **[Connect to PC (built-in Wi-Fi)]** > **[Network settings]** option in the setup menu.

---

## Troubleshooting Built-in Wi-Fi

Solutions to some common issues are listed below.

- Troubleshooting information for the SnapBridge app can be found in the app's online help, which can be viewed at: <https://nikonimglib.com/snbr/onlinehelp/en/index.html>
- For information on the Wireless Transmitter Utility, see the utility's online help.

<b>Problem</b>	<b>Solution</b>
The camera displays a TCP/IP error.	Connection settings require adjustment. Check settings for the host computer or wireless router and adjust camera settings appropriately (📖 933).
The camera displays a "no memory card" error.	The memory card is inserted incorrectly or not at all. Confirm that the memory card is correctly inserted (📖 38).
Upload is interrupted and fails to resume.	Upload will resume if the camera is turned off and then on again (📖 503).

Problem	Solution
The connection is unreliable.	<p>If <b>[Auto]</b> is selected for <b>[Channel]</b> when you are connecting to a smart device, choose <b>[Manual]</b> and select the channel manually (☞ 931).</p> <hr/> <p>If the camera is connected to a computer in infrastructure mode, check that the router is set to a channel between 1 and 8 (☞ 933).</p>
<p><b>[Connect to smart device]</b> and <b>[Connect to PC (built-in Wi-Fi)]</b> are grayed out and cannot be selected.</p>	<p>These options are not available when the camera is connected via Ethernet or using a WT-6. Select <b>[Disable]</b> for <b>[Wired LAN/WT] &gt; [Wired LAN/WT functions]</b> in the setup menu (☞ 937).</p>

# Ethernet/WT-6

## Ethernet Connections and the WT-6

The camera can connect to existing networks via a third-party Ethernet cable inserted in the camera's Ethernet connector or an optional WT-6 wireless transmitter attached via the peripheral connector. The connection is more reliable than that offered by the camera's built-in Wi-Fi.

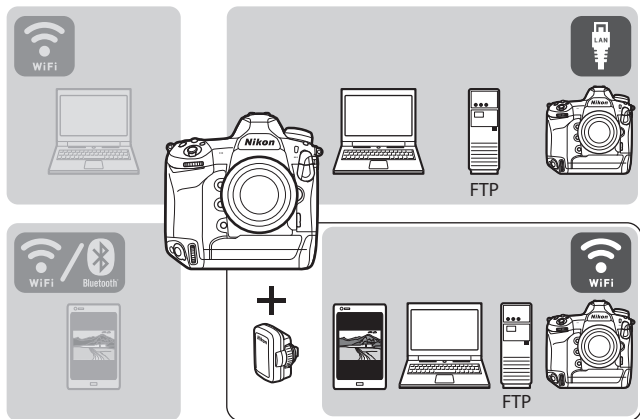

## **The Wireless Transmitter Utility**

Before you will be able to upload images via Wi-Fi, you will need to pair the camera with the computer using Nikon's Wireless Transmitter Utility software.

- Once the devices are paired, you will be able to connect to the computer from the camera.
- The Wireless Transmitter Utility is available for download from the Nikon Download Center. Be sure to download the latest version after reading the release notes and system requirements.

<https://downloadcenter.nikonimglib.com/>

## What Ethernet and the WT-6 Can Do for You

Ethernet and the WT-6 can be used for the following tasks.

### Upload to FTP Servers or Computers

Not only can you copy pictures to computers, you can also upload them to ftp servers (📖 585). Pictures can be uploaded as they are taken.

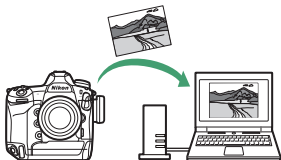



## **Computer-Based Remote Photography (Camera Control Mode)**

Installing Camera Control Pro 2 (available separately) on a network computer gives you complete control over camera settings and lets you take pictures remotely and save them directly to the computer hard disk (📖 595).

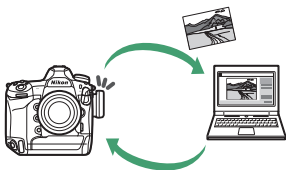

## **Browser-Based Remote Photography (HTTP Server Mode)**

Use a web browser to control the camera from network computers and smart devices (📖 601). No dedicated app is required.

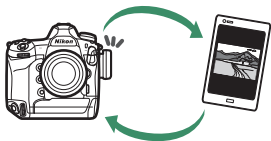

## Camera-Based Remote Photography (Synchronized Release)

A master camera can be used to control the shutters on one or more remote cameras (📖 628). The cameras must have WT-6 wireless transmitters attached.

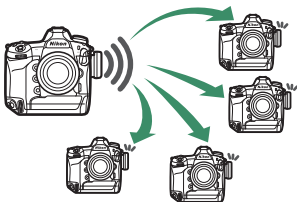

## Clock Synchronization (Synchronize Date and Time)

Synchronize the clocks on two cameras via a network (📖 633).

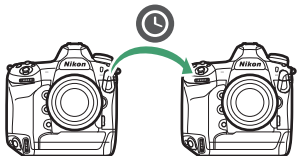

---

## **Ethernet Connections**

Wireless LAN settings are not required when the camera is connected to a network via an Ethernet cable.

## **FTP Servers**

- Servers can be configured using standard ftp services—including IIS (Internet Information Services)—available with Windows 10 (Enterprise/Pro/Home), Windows 8.1, and Windows 8.1 (Enterprise/Pro).
- Internet ftp connections and connection to ftp servers running third-party software are not supported.

## **HTTP Sever Mode**

Internet connections are not supported in http server mode.

## **Routers**

- Connection to computers on other networks via a router is not supported. You can connect only to computers on the same network.
- Connection to ftp servers via a router is however supported.

## **Firewall Settings**

TCP ports 21 and 32768 through 61000 are used for **[FTP]**, TCP ports 22 and 32768 through 61000 for **[SFTP]**. TCP port 15740 and UDP port 5353 are used for connections to computers. File transfer may be blocked if the server firewall is not configured to allow access to these ports.

---

## Connecting an Ethernet Cable or WT-6

### Connecting an Ethernet Cable

Insert the Ethernet cable into the camera's Ethernet connector. Do not use force or insert the connectors at an angle. Connect the other end of the cable to the computer or router.

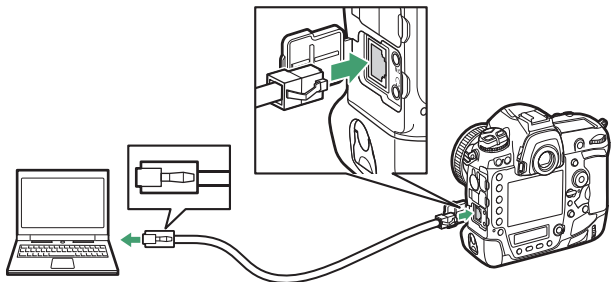

- Select [**Wired LAN**] for [**Wired LAN/WT**] > [**Choose hardware**] in the setup menu.



## Attaching the WT-6

Rotate the peripheral connector cover up out of the way (①) and fully insert the connectors on the WT-6 into the camera's peripheral connector (②). Rotate the locking wheel to lock the WT-6 in place (③).

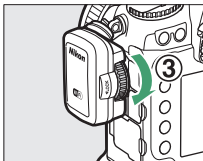
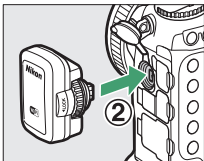
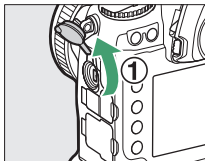

- Select [**Wireless LAN**] for [**Wired LAN/WT**] > [**Choose hardware**] in the setup menu.



---

### ✔ Choosing a Power Source

To prevent the camera powering off unexpectedly during setup or data transfer, use a fully-charged battery or an optional AC adapter.

---

## Creating a Network Profile (Ethernet)

Before connecting the camera to a computer or ftp server in [Image transfer], [FTP upload], [Camera control], or [HTTP server] mode, you will need to create a network profile.

- Before creating a network profile, select [Enable] for [Wired LAN/WT] > [Wired LAN/WT functions] in the setup menu.

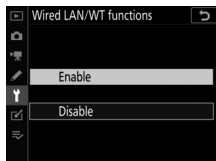

- Select [Wired LAN] for [Wired LAN/WT] > [Choose hardware] in the setup menu.



- For information on creating network profiles for use when connecting to wireless LANs using the WT-6, see "Creating Network Profiles (WT-6)" (📖 544).

# Image Transfer and Camera Control Modes

Follow the on-screen instructions to create a network profile.

- 1 In the setup menu, select [Wired LAN/WT], then highlight [Network settings] and press .**

The camera will display a list of network profiles.

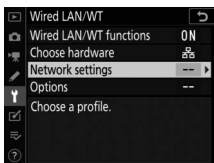

- 2 Highlight [Create profile] and press .**

- You will be prompted to choose between the connection wizard and manual setup.
- Note that **[Create profile]** will not be available if the profile list already contains nine profiles. Before creating a new profile, you must first delete an existing profile using the  (**FORMAT**) button.

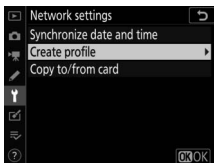

### 3 Highlight [Connection wizard] and press .

The connection wizard will start.



---

#### Manual Configuration

Choose [**Configure manually**] to configure [**FTP upload**] and [**HTTP server**] settings manually. Choose [**Connection wizard**] to create network profiles for use with [**Image transfer**] and [**Camera control**].

---

### 4 Choose a connection type.

Highlight [**Image transfer**] or [**Camera control**] and press  to display the default profile name.

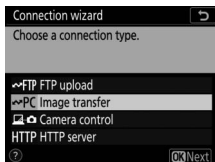



## 5 Rename the new network profile.

- To proceed to IP address selection without renaming the profile, press **OK**.
- The profile name will appear in the **[Wired LAN/WT] > [Network settings]** list in the camera setup menu.
- To rename the profile, press the center of the multi selector.

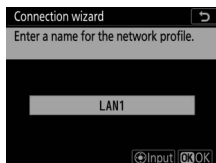

## 6 Obtain or select an IP address.

- Highlight one of the following options and press **OK**.

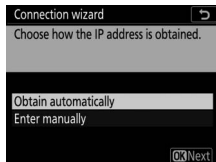

Option	Description
<b>[Obtain automatically]</b>	Select this option if the network is configured to supply the IP address automatically. A “configuration complete” message will be displayed once an IP address has been assigned.
<b>[Enter manually]</b>	Enter the IP address and sub-net mask manually. <ul style="list-style-type: none"><li>• Press the center of the multi selector to display a dialog where you can manually enter an IP address.</li><li>• Rotate the main command dial to highlight segments.</li><li>• Press <b>⬅</b> or <b>➡</b> to change the highlighted segment and press the center of the multi selector to save changes.</li><li>• Next, press <b>OK</b>; a “configuration complete” message will be displayed. Press <b>OK</b> again to display the sub-net mask.</li><li>• Press <b>⬅</b> or <b>➡</b> to edit the sub-net mask and press <b>OK</b>; a “configuration complete” message will be displayed.</li></ul>

- Press **OK** to proceed when the “configuration complete” message is displayed.

## 7 Start pairing.

When prompted, launch the Wireless Transmitter Utility on the computer.



## 8 Select the camera in the Wireless Transmitter Utility.

Select the name displayed by the camera in Step 7 and click **[Next>]**.

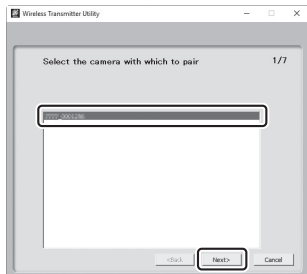

## 9 In the Wireless Transmitter Utility, enter the authentication code displayed by the camera.

- The camera will display an authentication code.
- Enter the authentication code in the dialog displayed by the Wireless Transmitter Utility and click **[Next>]**.

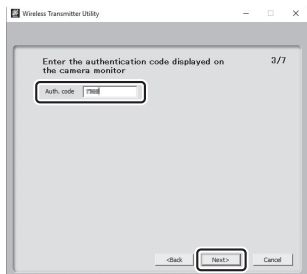

## 10 Complete the pairing process.

- When the camera displays a message stating that pairing is complete, press **OK**.
- In the Wireless Transmitter Utility, click [**Next>**]; you will be prompted to choose a destination folder. For more information, see online help for the Wireless Transmitter Utility.

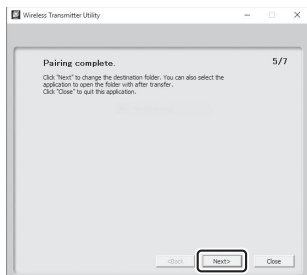
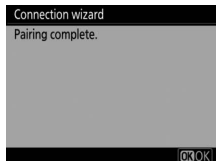

## 11 Exit the wizard.

Highlight one of the following options and press **OK**.

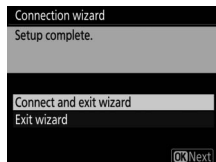

Option	Description
[ <b>Connect and exit wizard</b> ]	Save the new network profile and connect to the server.
[ <b>Exit wizard</b> ]	Save the new network profile and exit.

*Connection settings for the camera and computer are now complete.*

*Pictures taken with the camera can be uploaded to the computer as described in "Upload to Computers and FTP Servers" (📖 585).*

*For information on controlling the camera from a computer using Camera Control Pro 2, see "Camera Control" (📖 595).*

## HTTP Server Mode

Follow the on-screen instructions to create a network profile.

- 1 In the setup menu, select [Wired LAN/WT], then highlight [Network settings] and press .**

The camera will display a list of network profiles.

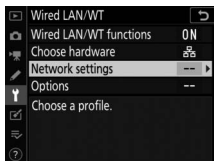

- 2 Highlight [Create profile] and press .**

- You will be prompted to choose between the connection wizard and manual setup.
- Note that **[Create profile]** will not be available if the profile list already contains nine profiles. Before creating a new profile, you must first delete an existing profile using the  (**FORMAT**) button.

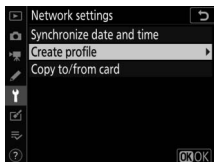

### 3 Highlight [Connection wizard] and press .

The connection wizard will start.



---

#### Manual Configuration

Choose [**Configure manually**] to adjust settings manually.

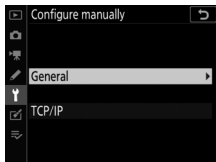



---

## 4 Choose a connection type.

Highlight [**HTTP server**] and press **OK** to display the default profile name.

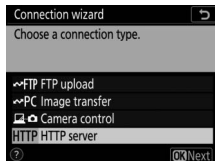

---

## 5 Rename the new network profile.

- To proceed to IP address selection without renaming the profile, press **OK**.
- The profile name will appear in the [**Wired LAN/WT**] > [**Network settings**] list in the camera setup menu.
- To rename the profile, press the center of the multi selector.

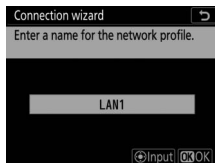

## 6 Obtain or select an IP address.

- Highlight one of the following options and press **OK**.

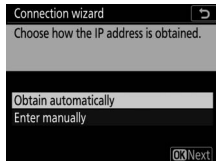

Option	Description
<b>[Obtain automatically]</b>	Select this option if the network is configured to supply the IP address automatically. A “configuration complete” message will be displayed once an IP address has been assigned.
<b>[Enter manually]</b>	Enter the IP address and sub-net mask manually. <ul style="list-style-type: none"><li>• Press the center of the multi selector to display a dialog where you can manually enter an IP address.</li><li>• Rotate the main command dial to highlight segments.</li><li>• Press <b>Left Arrow</b> or <b>Right Arrow</b> to change the highlighted segment and press the center of the multi selector to save changes.</li><li>• Next, press <b>OK</b>; a “configuration complete” message will be displayed. Press <b>OK</b> again to display the sub-net mask.</li><li>• Press <b>Up Arrow</b> or <b>Down Arrow</b> to edit the sub-net mask and press <b>OK</b>; a “configuration complete” message will be displayed.</li></ul>

- Press **OK** to proceed when the “configuration complete” message is displayed.

## 7 Exit the wizard.

Highlight one of the following options and press **OK**.

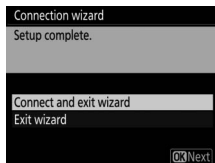

Option	Description
<b>[Connect and exit wizard]</b>	Save the new network profile and connect to the server.
<b>[Exit wizard]</b>	Save the new network profile and exit.

*Connection settings for the camera and computer are now complete.*

*You can now access and control the camera from a computer or smart device as described in “HTTP Server” (📖 601).*

## FTP Upload Mode



Follow the on-screen instructions to create a network profile.

- 1 In the setup menu, select [Wired LAN/WT], then highlight [Network settings] and press .**

The camera will display a list of network profiles.



- 2 Highlight [Create profile] and press .**

- You will be prompted to choose between the connection wizard and manual setup.
- Note that **[Create profile]** will not be available if the profile list already contains nine profiles. Before creating a new profile, you must first delete an existing profile using the  () button.

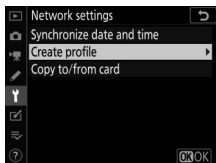

---

### 3 Highlight [Connection wizard] and press .

The connection wizard will start.



---

#### **Manual Configuration**

Choose [**Configure manually**] to adjust settings manually.

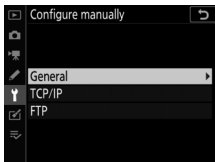

## 4 Select [FTP upload].

The default profile name will be displayed when you press **OK**.

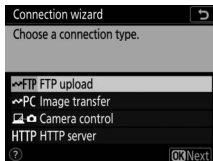

## 5 Rename the new network profile.

- To proceed to IP address selection without renaming the profile, press **OK**.
- The profile name will appear in the **[Wired LAN/WT] > [Network settings]** list in the camera setup menu.
- To rename the profile, press the center of the multi selector.

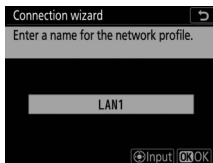

## 6 Obtain or select an IP address.

- Highlight one of the following options and press **OK**:

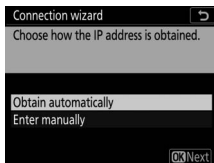

Option	Description
<b>[Obtain automatically]</b>	Select this option if the network is configured to supply the IP address automatically. A “configuration complete” message will be displayed once an IP address has been assigned.
<b>[Enter manually]</b>	Enter the IP address and sub-net mask manually. <ul style="list-style-type: none"><li>• Press the center of the multi selector to display a dialog where you can manually enter an IP address.</li><li>• Rotate the main command dial to highlight segments.</li><li>• Press <b>Left Arrow</b> or <b>Right Arrow</b> to change the highlighted segment and press the center of the multi selector to save changes.</li><li>• Next, press <b>OK</b>; a “configuration complete” message will be displayed. Press <b>OK</b> again to display the sub-net mask.</li><li>• Press <b>Left Arrow</b> or <b>Right Arrow</b> to edit the sub-net mask and press <b>OK</b>; a “configuration complete” message will be displayed.</li></ul>

- Press **OK** to proceed when the “configuration complete” message is displayed.

## 7 Choose the server type.

Highlight **[FTP]** or **[SFTP]** (secure ftp) and press **OK**.

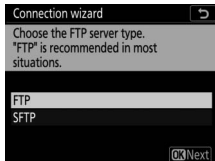

## 8 Enter the IP address.

- Press the center of the multi selector and enter the server URL or IP address.

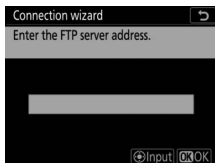

- Press **OK** when entry is complete.



- Press **OK** again to connect to the ftp server. You will be prompted to choose a login method.





## 9 Log in.

Highlight one of the following options and press **OK**.

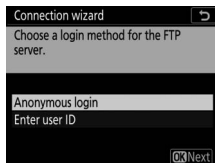

Option	Description
<b>[Anonymous login]</b>	Select this option if the server does not require a user ID or password. This option can only be used with servers that are configured for anonymous login. If login is successful, the camera will prompt you to choose a destination.
<b>[Enter user ID]</b>	Enter a user ID and password. Press <b>OK</b> to log in when entry is complete. If login is successful, the camera will prompt you to choose a destination.

### Firewall Settings

TCP ports 21 and 32768 through 61000 are used for **[FTP]**, TCP ports 22 and 32768 through 61000 for **[SFTP]**. File transfer may be blocked if the server firewall is not configured to allow access to these ports.

## 10 Choose a destination folder.

Highlight one of the following options and press **OK**.

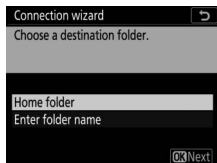

Option	Description
<b>[Home folder]</b>	Select this option to select the server's home folder as the destination for pictures uploaded from the camera. A "setup complete" dialog will be displayed if the operation is successful.
<b>[Enter folder name]</b>	Enter the destination folder name manually. The folder must already exist on the server. Enter the folder name and path when prompted and press <b>OK</b> to display the "setup complete" dialog.

## 11 Exit the wizard.

Highlight one of the following options and press **OK**.

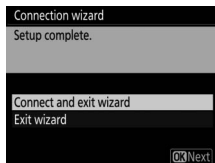

Option	Description
<b>[Connect and exit wizard]</b>	Save the new network profile and connect to the server.
<b>[Exit wizard]</b>	Save the new network profile and exit.

*Connection settings for the camera and ftp server are now complete.*

*You can now upload pictures as described in “Upload to Computers and FTP Servers” (📖 585).*

## Creating Network Profiles (WT-6)

Before connecting the camera to a computer or ftp server in [Image transfer], [FTP upload], [Camera control], or [HTTP server] mode, you will need to create a network profile.

- Before creating a network profile, select [Enable] for [Wired LAN/WT] > [Wired LAN/WT functions] in the setup menu.

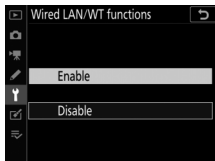

- Select [Wireless LAN] for [Wired LAN/WT] > [Choose hardware] in the setup menu.



- For information on creating network profiles for use when connecting via Ethernet, see “Creating Network Profiles (Ethernet)” (□ 522).

## **WT-6 Wireless Connection Options**

With a WT-6 attached, the camera can connect to computers or ftp servers using any of the following four options.

<b>Option</b>	<b>Description</b>
<b>[Search for wireless network]</b>	Connect to computers on existing home networks or the like via a wireless router. The computer can still connect to the Internet while connected to the camera.
<b>[Push-button WPS]</b>	If the wireless router is equipped with a WPS button, you can connect the camera to the router just by pressing the button.
<b>[PIN-entry WPS]</b>	Connect by using the computer to enter a PIN displayed on the camera into a wireless router.
<b>[Direct (access point)]</b>	Connect the camera to the computer or ftp server via a direct wireless link. The camera acts as a wireless LAN access point, letting you connect when working outdoors and in other situations in which the computer is not already connected to a wireless network and eliminating the need for complicated adjustments to settings. The computer cannot connect to the Internet while connected to the camera.

- Each option can be configured in the connection wizard when you create a network profile.

# Image Transfer and Camera Control Modes



Follow the on-screen instructions to create a network profile.

- 1 In the setup menu, select [Wired LAN/WT], then highlight [Network settings] and press .**

The camera will display a list of network profiles.



- 2 Highlight [Create profile] and press .**

- You will be prompted to choose between the connection wizard and manual setup.
- Note that **[Create profile]** will not be available if the profile list already contains nine profiles. Before creating a new profile, you must first delete an existing profile using the  () button.

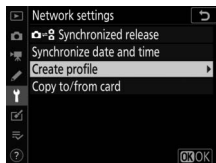

### 3 Highlight [Connection wizard] and press .

The connection wizard will start.

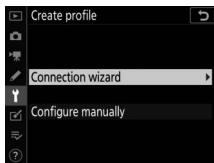

#### Manual Configuration

Choose [**Configure manually**] to configure [**FTP upload**] and [**HTTP server**] settings manually. Choose [**Connection wizard**] to create network profiles for use with [**Image transfer**] and [**Camera control**].

### 4 Choose a connection type.

Highlight [**Image transfer**] or [**Camera control**] and press  to display the default profile name.

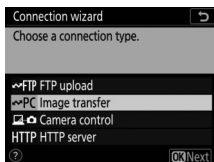

---

## 5 Rename the new network profile.

- To proceed to IP address selection without renaming the profile, press **OK**.
- The profile name will appear in the **[Wired LAN/WT] > [Network settings]** list in the camera setup menu.
- To rename the profile, press the center of the multi selector.

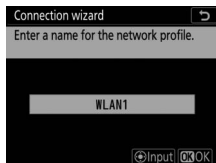

---

## 6 Choose a connection option.

- Highlight one of the following options and press **OK**.
- **[Search for wireless network]**: Proceed to Step 7.
- **[Push-button WPS]**: Proceed to Step 9.
- **[PIN-entry WPS]**: Proceed to Step 10.
- **[Direct (access point)]**: Proceed to Step 11.

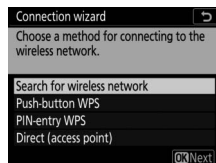



## 7 Choose a network.

- When [**Search for wireless network**] is selected, the camera will search for networks currently active in the vicinity and list them by name (SSID).
- Highlight a network SSID and press **OK**. Encrypted networks are indicated by a **lock** icon. If the selected network is encrypted (**lock**), you will be prompted to enter the encryption key. If the network is not encrypted, proceed to Step 12.
- If the desired network is not displayed, press **Q** to search again.



### ✓ Hidden SSIDs

Networks with hidden SSIDs are indicated by blank entries in the network list.

- To connect to a network with a hidden SSID, highlight a blank entry and press **OK**. Next, press the center of the multi selector; the camera will prompt you to provide an SSID.
- Enter the network name and press **OK**. Press **OK** again; the camera will now prompt you to enter the encryption key.

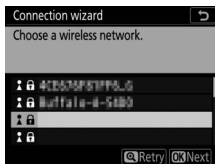



## 9 Press the WPS button on the router.

- Selecting [**Push-button WPS**] displays a WPS dialog.
- Press the WPS button on the router and then press the camera **OK** button to connect.
- For more information, see the documentation provided with the router.
- A confirmation dialog will be displayed when a connection is established. Press **OK** and proceed to Step 12.

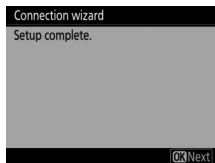
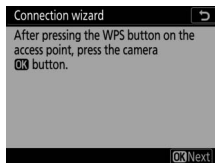

## 10 Enter a PIN code into the router.

- Selecting **[PIN-entry WPS]** displays a PIN.
- Using a computer, enter the PIN on the router. For more information, see the documentation provided with the router.
- A confirmation dialog will be displayed when a connection is established. Press **OK** and proceed to Step 12.



## 11 Establish a connection to the camera.

When [**Direct (access point)**] is selected, the camera will display an SSID and encryption key.



### Windows:

- Click the wireless LAN icon in the taskbar.
- Select the camera SSID.
- Enter the camera encryption key when prompted. The computer will initiate a connection to the camera. A pairing dialog will be displayed when a connection is established. Proceed to Step 13.

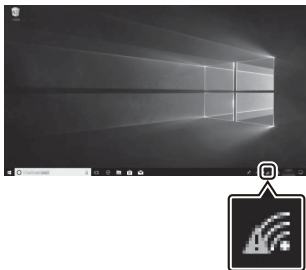

**macOS:**

- Click the wireless LAN icon in the menu bar.
- Select the camera SSID.
- Enter the camera encryption key when prompted. The computer will initiate a connection to the camera. A pairing dialog will be displayed when a connection is established. Proceed to Step 13.

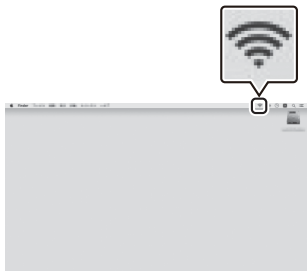

## 12 Obtain or select an IP address.

- Highlight one of the following options and press **OK**:

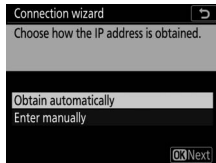

Option	Description
<b>[Obtain automatically]</b>	Select this option if the network is configured to supply the IP address automatically. A “configuration complete” message will be displayed once an IP address has been assigned.
<b>[Enter manually]</b>	Enter the IP address and sub-net mask manually. <ul style="list-style-type: none"><li>• Press the center of the multi selector to display a dialog where you can manually enter an IP address.</li><li>• Rotate the main command dial to highlight segments.</li><li>• Press <b>←</b> or <b>→</b> to change the highlighted segment and press the center of the multi selector when entry is complete.</li><li>• Next, press <b>OK</b>; a “configuration complete” message will be displayed. Press <b>OK</b> again to display the sub-net mask.</li><li>• Press <b>←</b> or <b>→</b> to edit the sub-net mask and press <b>OK</b>; a “configuration complete” message will be displayed.</li></ul>

- Press **OK** to proceed when the “configuration complete” message is displayed.

## 13 Start pairing.

When prompted, launch the Wireless Transmitter Utility on the computer.



## 14 Select the camera in the Wireless Transmitter Utility.

Select the name displayed by the camera in Step 13 and click **[Next>]**.

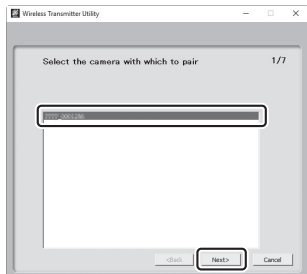



## 15 In the Wireless Transmitter Utility, enter the authentication code displayed by the camera.

- The camera will display an authentication code.
- Enter the authentication code in the dialog displayed by the Wireless Transmitter Utility and click **[Next>]**.

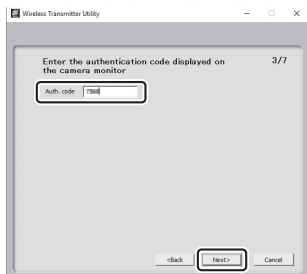

## 16 Complete the pairing process.

- When the camera displays a message stating that pairing is complete, press **OK**.
- In the Wireless Transmitter Utility, click **[Next>]**; you will be prompted to choose a destination folder. For more information, see online help for the Wireless Transmitter Utility.

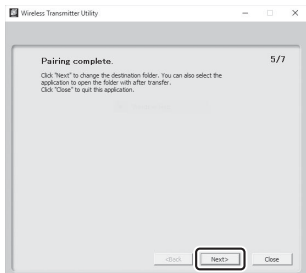

## 17 Exit the wizard.

Highlight one of the following options and press **OK**.

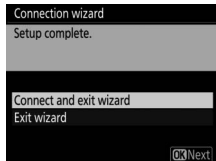

Option	Description
<b>[Connect and exit wizard]</b>	Save the new network profile and connect to the host.
<b>[Exit wizard]</b>	Save the new network profile and exit.

*Wireless network profiles have now been created on both the camera and the computer.*

*Pictures taken with the camera can be uploaded to the computer as described in “Upload to Computers and FTP Servers” (📖 585).*

*For information on controlling the camera from a computer using Camera Control Pro 2, see “Camera Control” (📖 595).*

## HTTP Server Mode



Follow the on-screen instructions to create a network profile.

- 1 In the setup menu, select [Wired LAN/WT], then highlight [Network settings] and press .**

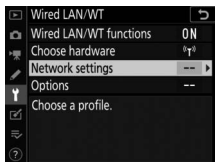
The camera will display a list of network profiles.



- 2 Highlight [Create profile] and press .**

- You will be prompted to choose between the connection wizard and manual setup.
- Note that **[Create profile]** will not be available if the profile list already contains nine profiles. Before creating a new profile, you must first delete an existing profile using the  () button.

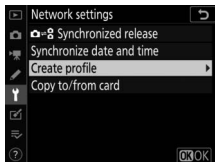

### 3 Highlight [Connection wizard] and press .

The connection wizard will start.



#### **Manual Configuration**

Choose [**Configure manually**] to adjust settings manually.

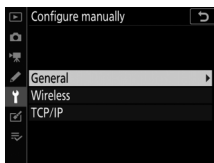

### 4 Choose a connection type.

Highlight [**HTTP server**] and press .

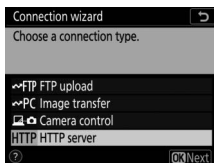

---

## 5 Rename the new network profile.

- To proceed to IP address selection without renaming the profile, press **OK**.
- The profile name will appear in the **[Wired LAN/WT] > [Network settings]** list in the camera setup menu.
- To rename the profile, press the center of the multi selector.

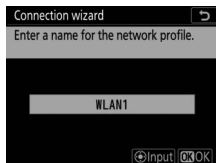

---

## 6 Choose a connection option.

- Highlight one of the following options and press **OK**.
- **[Search for wireless network]**: Proceed to Step 7.
- **[Push-button WPS]**: Proceed to Step 9.
- **[PIN-entry WPS]**: Proceed to Step 10.
- **[Direct (access point)]**: Proceed to Step 11.

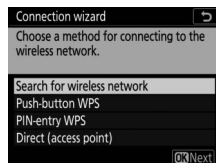

## 7 Choose a network.

- When [**Search for wireless network**] is selected, the camera will search for networks currently active in the vicinity and list them by name (SSID).
- Highlight a network SSID and press **OK**. Encrypted networks are indicated by a **lock** icon. If the selected network is encrypted (**lock**), you will be prompted to enter the encryption key. If the network is not encrypted, proceed to Step 12.
- If the desired network is not displayed, press **Q** to search again.

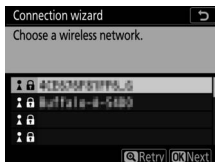

### ✓ Hidden SSIDs

Networks with hidden SSIDs are indicated by blank entries in the network list.

- To connect to a network with a hidden SSID, highlight a blank entry and press **OK**. Next, press the center of the multi selector; the camera will prompt you to provide an SSID.
- Enter the network name and press **OK**. Press **OK** again; the camera will now prompt you to enter the encryption key.

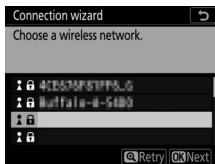





---

## 9 Press the WPS button on the router.

- Selecting [**Push-button WPS**] displays a WPS dialog.
- Press the WPS button on the router and then press the camera **OK** button to connect.
- For more information, see the documentation provided with the router.
- A confirmation dialog will be displayed when a connection is established. Press **OK** and proceed to Step 12.

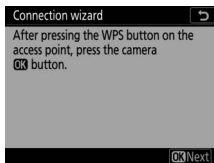

## 10 Enter a PIN code into the router.

- Selecting [PIN-entry WPS] displays a PIN.
- Using a computer, enter the PIN on the router. For more information, see the documentation provided with the router.
- A confirmation dialog will be displayed when a connection is established. Press **OK** and proceed to Step 12.



## 11 Establish a connection to the camera.

When [**Direct (access point)**] is selected, the camera will display an SSID and encryption key.



### Windows:

- Click the wireless LAN icon in the taskbar.
- Select the camera SSID.
- Enter the camera encryption key when prompted. The computer will initiate a connection to the camera. A pairing dialog will be displayed when a connection is established. Proceed to Step 13.

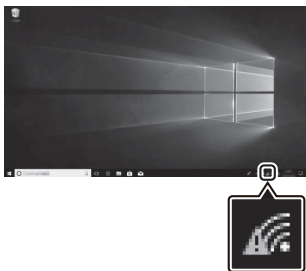

**macOS:**

- Click the wireless LAN icon in the menu bar.
- Select the camera SSID.
- Enter the camera encryption key when prompted. The computer will initiate a connection to the camera. A pairing dialog will be displayed when a connection is established. Proceed to Step 13.

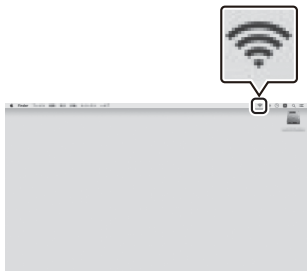

## 12 Obtain or select an IP address.

- Highlight one of the following options and press **OK**:

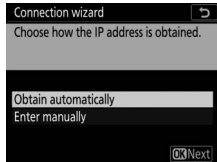

Option	Description
<b>[Obtain automatically]</b>	Select this option if the network is configured to supply the IP address automatically. A “configuration complete” message will be displayed once an IP address has been assigned.
<b>[Enter manually]</b>	Enter the IP address and sub-net mask manually. <ul style="list-style-type: none"><li>• Press the center of the multi selector to display a dialog where you can manually enter an IP address.</li><li>• Rotate the main command dial to highlight segments.</li><li>• Press <b>⬅</b> or <b>➡</b> to change the highlighted segment and press the center of the multi selector when entry is complete.</li><li>• Next, press <b>OK</b>; a “configuration complete” message will be displayed. Press <b>OK</b> again to display the sub-net mask.</li><li>• Press <b>⬅</b> or <b>➡</b> to edit the sub-net mask and press <b>OK</b>; a “configuration complete” message will be displayed.</li></ul>

- Press **OK** to proceed when the “configuration complete” message is displayed.

## 13 Exit the wizard.

Highlight one of the following options and press **OK**.

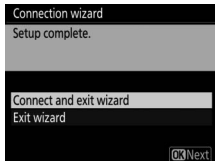

Option	Description
[ <b>Connect and exit wizard</b> ]	Save the new network profile and connect to the host.
[ <b>Exit wizard</b> ]	Save the new network profile and exit.

*Wireless network profiles have now been created on both the camera and the computer.*

*You can now access and control the camera from a computer or smart device as described in “HTTP Server” (📖 601).*

## FTP Upload Mode

Follow the on-screen instructions to create a network profile.

- 1 In the setup menu, select [Wired LAN/WT], then highlight [Network settings] and press .**

The camera will display a list of network profiles.



- 2 Highlight [Create profile] and press .**

- You will be prompted to choose between the connection wizard and manual setup.
- Note that **[Create profile]** will not be available if the profile list already contains nine profiles. Before creating a new profile, you must first delete an existing profile using the  (**FORMAT**) button.

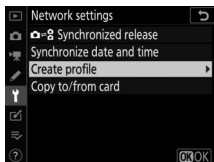

### 3 Highlight [Connection wizard] and press .

The connection wizard will start.

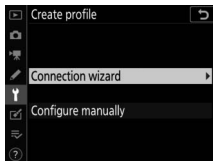

#### Manual Configuration

Choose [**Configure manually**] to adjust settings manually.

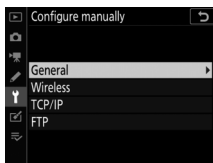

### 4 Select [FTP upload].

The default profile name will be displayed when you press .

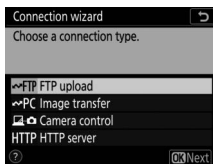



---

## 5 Rename the new network profile.

- To proceed to IP address selection without renaming the profile, press **OK**.
- The profile name will appear in the **[Wired LAN/WT] > [Network settings]** list in the camera setup menu.
- To rename the profile, press the center of the multi selector.

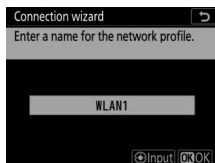

---

## 6 Choose a connection option.

- Highlight one of the following options and press **OK**.
- **[Search for wireless network]**: Proceed to Step 7.
- **[Push-button WPS]**: Proceed to Step 9.
- **[PIN-entry WPS]**: Proceed to Step 10.
- **[Direct (access point)]**: Proceed to Step 11.

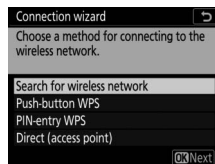

## 7 Choose a network.

- When [**Search for wireless network**] is selected, the camera will search for networks currently active in the vicinity and list them by name (SSID).
- Highlight a network SSID and press **OK**. Encrypted networks are indicated by a **lock** icon. If the selected network is encrypted (**lock**), you will be prompted to enter the encryption key. If the network is not encrypted, proceed to Step 12.
- If the desired network is not displayed, press **Retry** to search again.

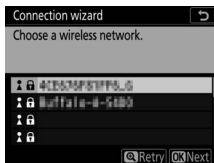

### ✓ Hidden SSIDs

Networks with hidden SSIDs are indicated by blank entries in the network list.

- To connect to a network with a hidden SSID, highlight a blank entry and press **OK**. Next, press the center of the multi selector; the camera will prompt you to provide an SSID.
- Enter the network name and press **OK**. Press **OK** again; the camera will now prompt you to enter the encryption key.

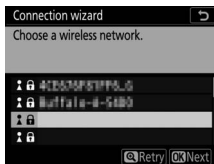

## 8 Enter the encryption key.

- Press the center of the multi selector and enter the encryption key for the wireless router.
- For more information, see the documentation for the wireless router.
- Press **OK** when entry is complete.
- Press **OK** again to initiate the connection. A message will be displayed for a few seconds when the connection is established.
- You will next be prompted to supply an IP address. Proceed to Step 12.

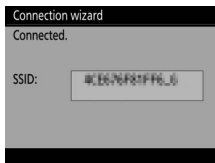
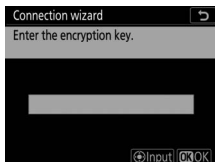

## 9 Press the WPS button on the router.

- Selecting **[Push-button WPS]** displays a WPS dialog.
- Press the WPS button on the router and then press the camera **OK** button to connect.
- For more information, see the documentation provided with the router.
- A confirmation dialog will be displayed when a connection is established. Press **OK** and proceed to Step 12.

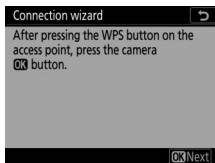

## 10 Enter a PIN code into the router.

- Selecting [PIN-entry WPS] displays a PIN.
- Using a computer, enter the PIN on the router. For more information, see the documentation provided with the router.
- A confirmation dialog will be displayed when a connection is established. Press **OK** and proceed to Step 12.



## 11 Establish a connection to the camera.

When **[Direct (access point)]** is selected, the camera will display an SSID and encryption key.



### Windows:

- Click the wireless LAN icon in the taskbar.
- Select the camera SSID.
- Enter the camera encryption key when prompted. The computer will initiate a connection to the camera. A pairing dialog will be displayed when a connection is established. Proceed to Step 13.

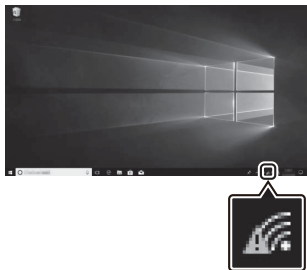

**macOS:**

- Click the wireless LAN icon in the menu bar.
- Select the camera SSID.
- Enter the camera encryption key when prompted. The computer will initiate a connection to the camera. A pairing dialog will be displayed when a connection is established. Proceed to Step 13.

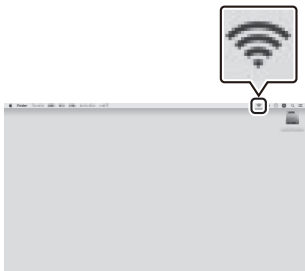

## 12 Obtain or select an IP address.

- Highlight one of the following options and press **OK**:

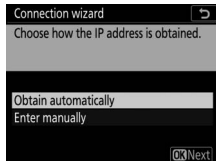

Option	Description
<b>[Obtain automatically]</b>	Select this option if the network is configured to supply the IP address automatically. A “configuration complete” message will be displayed once an IP address has been assigned.
<b>[Enter manually]</b>	Enter the IP address and sub-net mask manually. <ul style="list-style-type: none"><li>• Press the center of the multi selector to display a dialog where you can manually enter an IP address.</li><li>• Rotate the main command dial to highlight segments.</li><li>• Press <b>Left Arrow</b> or <b>Right Arrow</b> to change the highlighted segment and press the center of the multi selector when entry is complete.</li><li>• Next, press <b>OK</b>; a “configuration complete” message will be displayed. Press <b>OK</b> again to display the sub-net mask.</li><li>• Next, press <b>Up Arrow</b> or <b>Down Arrow</b> to edit the sub-net mask and press <b>OK</b>; a “configuration complete” message will be displayed.</li></ul>

- Press **OK** to proceed when the “configuration complete” message is displayed.



---

## 13 Choose the server type.

- Highlight [FTP] or [SFTP] (secure ftp) and press **OK**.
- If you selected [**Direct (access point)**] in Step 6, proceed to Step 15.

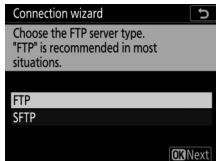

---

## 14 Enter the IP address.

- Press the center of the multi selector and enter the server URL or IP address.
- Press **OK** when entry is complete.

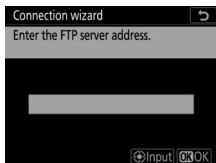

- Press **OK** again to connect to the ftp server. You will be prompted to choose a login method.



## 15 Log in.

Highlight one of the following options and press **OK**.

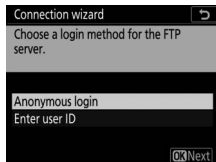

Option	Description
<b>[Anonymous login]</b>	Select this option if the server does not require a user ID or password. This option can only be used with servers that are configured for anonymous login. If login is successful, the camera will prompt you to choose a destination.
<b>[Enter user ID]</b>	Enter a user ID and password. Press <b>OK</b> to log in when entry is complete. If login is successful, the camera will prompt you to choose a destination.

---

## Firewall Settings

TCP ports 21 and 32768 through 61000 are used for [FTP], TCP ports 22 and 32768 through 61000 for [SFTP]. File transfer may be blocked if the server firewall is not configured to allow access to these ports.

---

## 16 Choose a destination folder.

Highlight one of the following options and press **OK**.

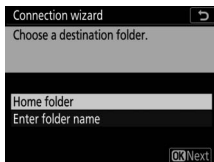

Option	Description
[Home folder]	Select this option to select the server's home folder as the destination for pictures uploaded from the camera. A "setup complete" dialog will be displayed if the operation is successful.
[Enter folder name]	Enter the destination folder name manually. The folder must already exist on the server. Enter the folder name and path when prompted and press <b>OK</b> to display the "setup complete" dialog.

## 17 Exit the wizard.

Highlight one of the following options and press **OK**.

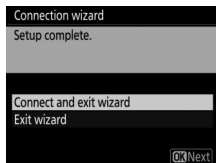

Option	Description
[ <b>Connect and exit wizard</b> ]	Save the new network profile and connect to the ftp server.
[ <b>Exit wizard</b> ]	Save the new network profile and exit.

*Wireless network profiles have now been created on both the camera and the ftp server.*

*You can now upload pictures as described in "Upload to Computers and FTP Servers" (📖 585).*

## Upload to Computers and FTP Servers

Pictures can be selected for upload to a computer or ftp server during playback. They can also be uploaded automatically as they are taken.

### Connecting to a Computer or FTP Server

Connect to a computer or a ftp server via Ethernet or using a wireless transmitter.

#### 1 Select [Enable] for [Wired LAN/WT functions].

- When you press **OK**, the camera will connect using the most recently-used network profile. To connect using a different profile, proceed to Step 2.
- When a connection is established, the network name will be shown in green in the [Wired LAN/WT] display.
- If the network name is not displayed in green, connect using the computer's wireless network settings.

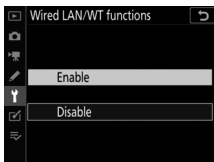

## 2 Choose an image transfer or ftp server profile in the [Network settings] display.

- Image transfer profiles are indicated by ↔PC, ftp server profiles by ↔FTP.
- When you press Ⓞ, the camera will exit to the [Wired LAN/WT] display and initiate the connection. The network name will be shown in green in the [Wired LAN/WT] display once a connection is established.
- If the network name is not displayed in green, connect using the computer's wireless network settings.

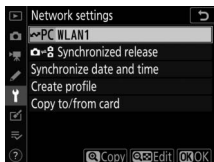

### ✓ Destination Folders

The default folders for pictures uploaded in image transfer mode are as follows:

- Windows: \Users\\Pictures\Wireless Transmitter Utility
- macOS: /Users/(user name)/Pictures/Wireless Transmitter Utility

The destination folder can be selected using the Wireless Transmitter Utility. For more information, see the utility's online help.

## ■ Selecting Pictures for Upload

**1** Press the  button on the camera and select full-frame or thumbnail playback.

**2** Display or highlight a picture you want to upload.

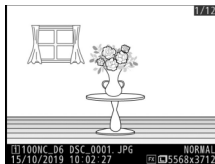

**3** Hold the  button and press the center of the multi selector.

- A white “send” (priority upload) icon will appear on the picture. If the camera is currently connected to a network, upload will begin immediately.
- Otherwise, upload will begin when a connection is established.
- Repeat Steps 2–3 to upload additional pictures.



---

### ✔ Deselecting Pictures

- To deselect a picture, hold the **OK** button and press the center of the multi selector again.
  - Transfer marking can also be removed using [**Select to send (wired LAN/WT)**] in the playback **i** menu.
  - To remove transfer marking from all pictures, use [**Wired LAN/WT**] > [**Options**] > [**Deselect all?**] in the setup menu.
- 

### ✔ Using the **i** Menu

You can also mark the current picture for upload by choosing [**Select to send (wired LAN/WT)**] in the playback **i** menu.

---



## ■ ■ Uploading Photos as They Are Taken

To upload new photos as they are taken, select **[On]** for **[Wired LAN/WT]** > **[Options]** > **[Auto send]** in the setup menu.

- Upload begins only after the photo has been recorded to the memory card. Be sure a memory card is inserted in the camera.
- Movies and photographs taken during filming are not uploaded automatically when recording is complete. They must instead be uploaded from the playback display.

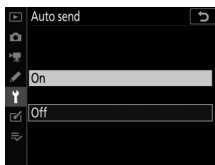

## ■ The Transfer Icon

Upload status is indicated by the transfer icon.

### 📤 (white): Send (priority upload)

The picture has been manually selected for upload. Pictures marked with this icon will be uploaded before pictures marked 📤 ("send").



### 📤 (white): Send

The picture has been selected for automatic upload but upload has not yet begun.

### 📤 (green): Sending

Upload in progress.

### 📤 (blue): Sent

Upload complete.

## ■ The [Wired LAN/WT] Status Display

The [Wired LAN/WT] display shows the following:

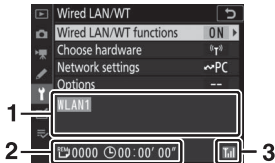

- 1 Status:** The status of the connection to the host. The profile name is displayed in green when a connection is established. While files are being transferred, the status display shows "Now sending" preceded by the name of the file being sent. Errors and error codes are also displayed here (📖 636).

- 2 Pictures/time remaining:** The number of pictures remaining and the time needed to send them. The time remaining is an estimate only.
- 3 Signal strength:** Ethernet connections are shown by 🌐. When the camera is connected to a wireless network, the icon instead shows the wireless signal strength.

---

**✔ Loss of Signal**

Wireless transmission may be interrupted if the signal is lost. Upload of pictures with “send” marking can be resumed by turning the camera off and then on again once the signal has been re-established.

**✔ During Upload**

Do not remove the memory card or disconnect the Ethernet cable or wireless transmitter during upload.

---

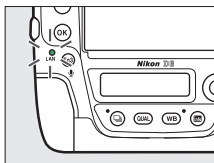

## Connection Status

Connection status is shown by the camera network indicator.



Network indicator	Status
● (off)	<ul style="list-style-type: none"><li>• <b>[Disable]</b> selected for <b>[Wired LAN/WT] &gt; [Wired LAN/WT functions]</b> in the setup menu.</li><li>• Ethernet cable not connected.</li></ul>
○ (green)	Waiting to connect.
⊙ (flashes green)	Connected.
⊙ (flashes amber)	Error.

## The Viewfinder Display

Connection status is also shown in the camera viewfinder.  is displayed when the camera is connected via Ethernet,  when it is connected to a wireless network. The icon will flash if an error occurs.



### **Firewall Settings**

TCP port 15740 and UDP port 5353 are used for connections to computers. File transfer may be blocked if the server firewall is not configured to allow access to these ports.

### **Voice Memos**

Voice memos will be included when the associated pictures are transmitted. They cannot, however, be uploaded separately.

### **Interval Timer Photography**

Choose a long standby time before starting the interval timer, as upload will be interrupted if the standby timer expires while interval-timer photography is in progress.

### **Turning the Camera Off**

The camera saves transfer marking when turned off and resumes upload when next turned on.

---

## Camera Control

Control the camera from a computer running Camera Control Pro 2 (available separately). Photos are saved directly to the computer instead of to the memory card and can consequently be taken even when no memory card inserted in the camera.

- You will still need to insert a memory card when filming movies.
- Note that the camera standby timer will not expire when the camera is in camera control mode.

# 1 Select [Enable] for [Wired LAN/WT] > [Wired LAN/WT functions] in the setup menu.

- When you press **OK**, the camera will connect using the most recently-used network profile. To connect using a different profile, proceed to Step 2. Otherwise, proceed to Step 3.
- When a connection is established, the network name will be shown in green in the [Wired LAN/WT] display.
- If the network name is not displayed in green, connect using the computer's wireless network settings.

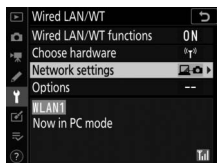
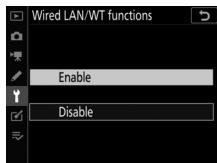



---

## 2 Choose a camera control profile in the [Network settings] display.

- Camera control profiles are indicated by a  icon.
- When you press **OK**, the camera will exit to the [**Wired LAN/WT**] display and initiate the connection. The network name will be shown in green in the [**Wired LAN/WT**] display once a connection is established.
- If the network name is not displayed in green, connect using the computer's wireless network settings.

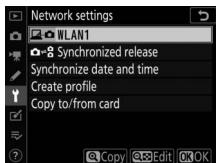

---

## 3 Launch the copy of Camera Control Pro 2 installed on the host computer.

---

## 4 Control the camera using Camera Control Pro 2.

For information on taking pictures using Camera Control Pro 2, see the Camera Control Pro 2 manual or online help.

## The [Wired LAN/WT] Status Display

The [Wired LAN/WT] display shows the following:

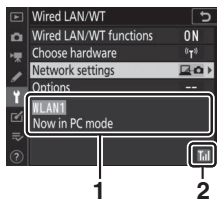

- 1 Status:** The status of the connection to the host. The profile name is displayed in green. Errors and error codes are also displayed here (□ 636).
- 2 Signal strength:** Ethernet connections are shown by . When the camera is connected to a wireless network, the icon instead shows the wireless signal strength.

### ✔ Loss of Signal

Loss of signal while the camera is connected to a wireless network may interrupt upload and disrupt the connection to Camera Control Pro 2. If the camera network indicator flashes amber, disable and re-enable the network connection by selecting first [**Disable**] and then [**Enable**] for [**Wired LAN/WT functions**]. When the signal is re-established, the camera will reconnect to Camera Control Pro 2 and resume upload of any images that have yet to be transferred. Note that upload cannot be resumed if you turn the camera off before transfer is complete.

## ✔ Ethernet Networks

Do not disconnect the Ethernet cable or wireless transmitter during upload or while the camera is on.

## ✔ Wireless Networks

Response may slow on wireless networks.

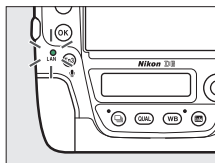

## ✔ Connection Status

Connection status is shown by the camera network indicator.



Network indicator	Status
● (off)	<ul style="list-style-type: none"><li>• <b>[Disable]</b> selected for <b>[Wired LAN/WT] &gt; [Wired LAN/WT functions]</b> in the setup menu.</li><li>• Ethernet cable not connected.</li></ul>
○ (green)	Waiting to connect.
⊙ (flashes green)	Connected.
⊙ (flashes amber)	Error.

## ✔ The Viewfinder Display

Connection status is also shown in the camera viewfinder.  is displayed when the camera is connected via Ethernet,  when it is connected to a wireless network. The icon will flash if an error occurs.



## ✔ Firewall Settings

TCP port 15740 and UDP port 5353 are used for connections to computers. File transfer may be blocked if the server firewall is not configured to allow access to these ports.

---

## HTTP Server

View the pictures on the camera memory card or take photographs from the web browser on a computer or smart device.

- For more information on system requirements, see “HTTP Server System Requirements” (📖 608).
- Up to five users can access the camera at one time. Only one, however, can take photographs or edit text.
- Note that the standby timer will not expire automatically when the camera is in http server mode.

### 1 Select [Enable] for [Wired LAN/WT] > [Wired LAN/WT functions] in the setup menu.

- When you press **OK**, the camera will connect using the most recently-used network profile. To connect using a different profile, proceed to Step 2. Otherwise, proceed to Step 3.

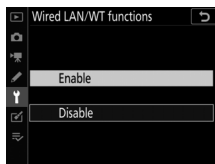

- When a connection is established, the URL to be used for connection to the camera will appear in the **[Wired LAN/WT]** display.



## 2 Choose an http server profile in the **[Network settings]** display.

- HTTP server profiles are indicated by an HTTP icon.
- When you press **OK**, the camera will exit to the **[Wired LAN/WT]** display and initiate the connection. The network name will be shown in green in the **[Wired LAN/WT]** display once a connection is established.

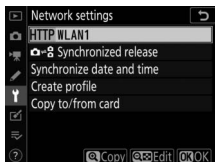

---

**3** Launch the web browser on the computer or smart device.

---

**4** Enter the camera URL (“http://” followed by the camera IP address) in the browser window address field.

- Enter the URL shown in the camera [Wired LAN/WT] display.
- A login dialog will be displayed.

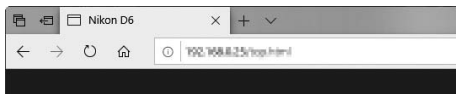

---

## 5 Enter your user name and password in the web browser login dialog.

- The default user name is “nikon” and the default password is blank.
- The server home page will be displayed.

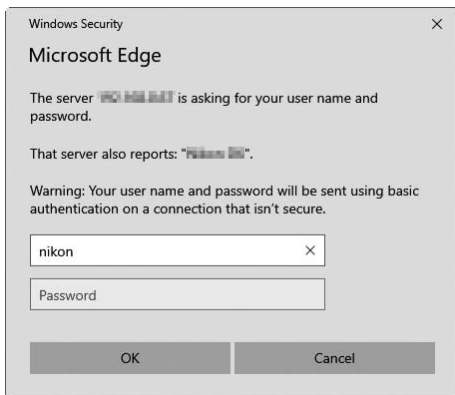

---

### User Name and Password

The user name and password used for login from web browsers can be selected using [**Wired LAN/WT**] > [**Options**] > [**HTTP user settings**] in the setup menu.

---



---

## 6 Click [Language] and choose the desired option.

Choose the desired language.

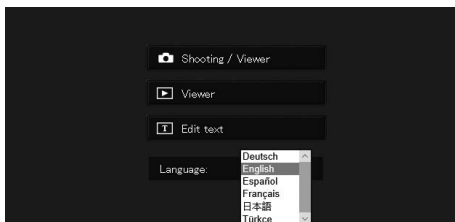

## 7 Choose [Shooting/Viewer], [Viewer], or [Edit text].

Option	Description
<b>[Shooting/Viewer]</b>	<p>Control the camera and take pictures remotely from a web browser on a computer or smart device. You can also view pictures (☐ 610, 622).</p> <ul style="list-style-type: none"><li>• Only one user can connect at a time. This option is not displayed if another user is currently connected using <b>[Shooting/Viewer]</b> or <b>[Edit text]</b>.</li></ul>
<b>[Viewer]</b>	<p>View the pictures on the camera memory card from a web browser on a computer or smart device (☐ 614, 625).</p> <ul style="list-style-type: none"><li>• Up to five users can connect at a time. Note, however, that only four users will be able to connect at a time if another user is currently connected using <b>[Shooting/Viewer]</b> or <b>[Edit text]</b>.</li></ul>
<b>[Edit text]</b>	<p>Use a web browser on a computer or smart device to edit image comments and copyright and IPTC information stored on the camera (☐ 617, 627).</p> <ul style="list-style-type: none"><li>• Only one user can connect at a time. This option is not displayed if another user is currently connected using <b>[Shooting/Viewer]</b> or <b>[Edit text]</b>.</li></ul>

## The [Wired LAN/WT] Status Display

The [Wired LAN/WT] display shows the following:

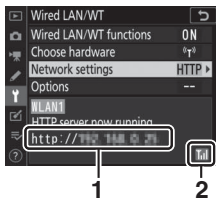

**1 Status:** The status of the connection to the host. The camera URL is displayed when a connection is established. Errors and error codes are also displayed here (□ 636).

**2 Signal strength:** Ethernet connections are shown by . When the camera is connected to a wireless network, the icon instead shows the wireless signal strength.

## ✔ HTTP Server System Requirements

Operation has been confirmed with the following systems:

### Windows

<b>OS</b>	Windows 10, Windows 8.1
<b>Browser</b>	<ul style="list-style-type: none"><li>• Windows 10: Microsoft Edge</li><li>• Windows 8.1: Internet Explorer 11</li></ul>

### macOS

<b>OS</b>	macOS version 10.14, 10.13, or 10.12
<b>Browser</b>	<ul style="list-style-type: none"><li>• macOS version 10.14: Safari 12</li><li>• macOS version 10.13: Safari 11</li><li>• macOS version 10.12: Safari 10</li></ul>

### Android OS

<b>OS</b>	Android version 9.0 or 8.1
<b>Browser</b>	Chrome

### iOS

<b>OS</b>	iOS version 12 or 11
<b>Browser</b>	The version of Safari included with the operating system

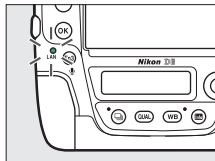

## Connection Status

Connection status is shown by the camera network indicator.



Network indicator	Status
● (off)	<ul style="list-style-type: none"><li>• <b>[Disable]</b> selected for <b>[Wired LAN/WT] &gt; [Wired LAN/WT functions]</b> in the setup menu.</li><li>• Ethernet cable not connected.</li></ul>
○ (green)	Waiting to connect.
⊛ (flashes green)	Connected.
⊛ (flashes amber)	Error.

## The Viewfinder Display

Connection status is also shown in the camera viewfinder.  is displayed when the camera is connected via Ethernet,  when it is connected to a wireless network. The icon will flash if an error occurs.



## **Computer, Android, and iPad Web Browsers**

Click or tap to adjust camera settings.

- For information on the displays for iPhones, see “iPhone Web Browsers” (📖 622).

## ■ The Shooting Window

The following controls can be accessed by selecting [Shooting/Viewer] on the server home page. To display the view through the camera lens in the viewfinder area, tap or click the “live view” button.

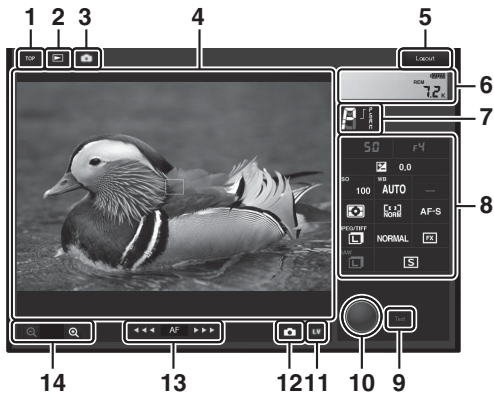



- |   |               |    |                                |
|---|---------------|----|--------------------------------|
| 1 | Home button   | 8  | Camera settings                |
| 2 | View button   | 9  | Test button                    |
| 3 | Shoot button  | 10 | Shutter-release button         |
| 4 | Viewfinder    | 11 | Live view button               |
| 5 | Logout button | 12 | Still photography/movie button |
| 6 | Display panel | 13 | Focus buttons                  |
| 7 | Exposure mode | 14 | Zoom buttons                   |

Option	Description
<b>Display panel</b>	View the exposure indicator, the battery level, and number of exposures remaining.
<b>Camera settings</b>	Adjust settings for photography or movie recording. Adjustments are made by clicking or tapping the icons.
<b>Shutter-release button</b>	<ul style="list-style-type: none"> <li>• <b>Photography:</b> Release the shutter.</li> <li>• <b>Filming:</b> Start recording. Click or tap again to end recording.</li> </ul>
<b>Test button</b>	Take a test photo and display it in the viewfinder. The picture is not recorded to the camera memory card.



---

## Enabling Live View on the Camera

When the view through the camera lens is displayed in the viewfinder area, pressing the camera  button will display the view through the lens in the camera monitor. Press the  button again to end live view on the camera.

## The Release-Mode Button

Rotating the camera release mode dial to  (quick release-mode selection) enables the browser-window release-mode button, which can be used to choose from single-frame, high-speed continuous, and low-speed continuous release modes. In high- and low-speed continuous release modes, the camera takes photographs while the browser shutter-release button is pressed.



## Focus Buttons

The size of the focus adjustment increases with the distance of the button from the center of the display. Use ① for smaller increases, ② for larger increases.

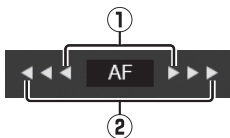

## Focusing

To focus, click or tap your subject in the viewfinder area.

---

## ■ The Viewer Window

The viewer window can be accessed by selecting [Viewer] on the server home page or by clicking or tapping the “view” button in the shooting window. The viewer window offers a choice of thumbnail, film-strip, and full-frame views.

### Thumbnail View

View multiple small (“thumbnail”) images per page.

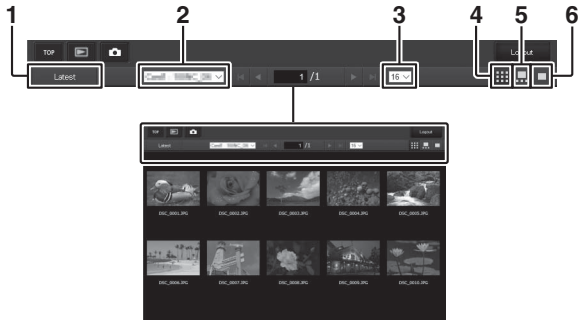

1 View most recent picture in folder

2 Folder selection

3 Thumbnails per page

4 Thumbnail view

5 Film-strip view

6 Full-frame view

## Film-Strip View

Choose the picture displayed from the thumbnails at the bottom of the window.



## Full-Frame View

Click or tap thumbnails to display pictures full frame.



---

### **The [Download] Button**

Click or tap the **[Download]** button to save the current picture to the computer or smart device.

### **Voice Memos**

Voice memos are listed as separate files.

### **Movies**

Movies are indicated by  icons.

---

## ■ The Text Edit Window

Selecting **[Edit text]** on the server home page displays the text edit window. The text edit window is used to edit the image comments and the copyright and IPTC information stored on the camera.

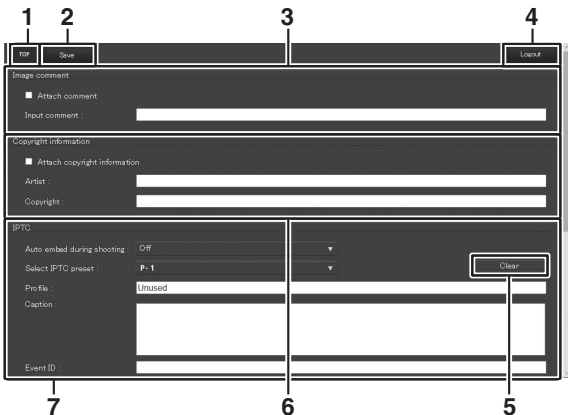

- 1 Home button
- 2 Save button
- 3 Image comment
- 4 Logout button
- 5 Clear button
- 6 Copyright information
- 7 IPTC information

---

### ✔ **Saving Changes**

Changes are not saved automatically. Click or tap the “save” button to save changes.

### ✔ **The “Clear” Button**

Clicking or tapping the “clear” button immediately deletes the displayed text. The text will be deleted even if you exit without clicking the “save” button.

---

### [Image Comment]

Create a comment that can be appended to subsequent images. Comments can be viewed as metadata in ViewNX-i or Capture NX-D.

Option	Description
[Attach comment]	Select ( <input checked="" type="checkbox"/> ) this option to enable comments. The current comment will be added to all pictures taken after you click the "save" button.
[Input comment]	Input a comment up to 36 characters long.

### [Copyright Information]

Add copyright information to new photographs as they are taken. Copyright information can be viewed as metadata in ViewNX-i or in Capture NX-D.

Option	Description
[Attach copyright information]	Select ( <input checked="" type="checkbox"/> ) this option to enable copyright information. The current copyright information will be added to all pictures taken after you click the "save" button.
[Artist]/ [Copyright]	Enter a photographer name up to 36 characters long and a copyright holder name up to 54 characters long.

---

### ✔ Copyright Information

- To prevent unauthorized use of the artist or copyright holder names, disable **[Attach copyright information]** before lending or transferring the camera to another person. You will also need to make sure that the artist and copyright fields are blank.
  - Nikon does not accept liability for any damages or disputes arising from the use of the **[Copyright information]** option.
- 

### ✔ Image Comments

- Image comments can be viewed on the **[Other shooting data]** page of the camera photo information display.
- To display the **[Other shooting data]** page, select (✔) both **[Shooting data]** and **[Other shooting data]** for **[Playback display options]** in the playback menu.

### ✔ Copyright Information

- Copyright information can be viewed on the **[Copyright info]** page of the camera photo information display.
  - To display the **[Copyright info]** page, select (✔) both **[Shooting data]** and **[Copyright info]** for **[Playback display options]** in the playback menu.
-



## [IPTC]

Embed IPTC presets in photographs as they are taken.

Option	Description
[Auto embed during shooting:]	Selecting [ <b>Auto embed during shooting:</b> ] displays a list of IPTC presets. Highlight a preset and click or tap the “save” button to embed the selected preset in all subsequent photos. Select [ <b>Off</b> ] to take photos with no IPTC presets.
[Select IPTC preset:]	Choosing [ <b>Select IPTC preset:</b> ] displays a list of IPTC presets. Choose a preset to copy to the camera.

---

### IPTC Information

Embedded IPTC information can be viewed by selecting the IPTC page in the photo information display during full-frame playback.

---

## **iPhone Web Browsers**

Tap to adjust camera settings.

- For information on computer, Android, or iPad displays, see “Computer, Android, and iPad Web Browsers” (📖 610).

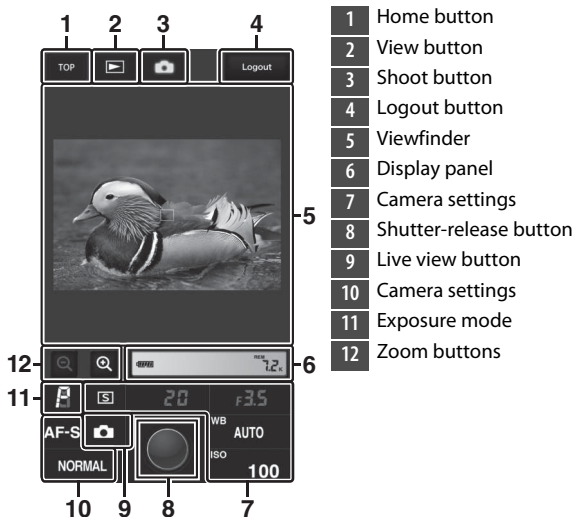

## ■ The Shooting Window

The following controls can be accessed by selecting [**Shooting/Viewer**] on the server home page. Use the “live view” button to initiate live view photography (📷) or ready the camera for filming (🎥). To exit live view, use the “live view” button to turn live view off.



---

## ✔ Enabling Live View on the Camera

When the view through the camera lens is displayed in the viewfinder area, pressing the camera  button will display the view through the lens in the camera monitor. Press the  button again to end live view on the camera.

## ✔ The Release-Mode Button

Rotating the camera release mode dial to  (quick release-mode selection) enables the browser-window release-mode button, which can be used to choose from single-frame, high-speed continuous, and low-speed continuous release modes. In high- and low-speed continuous release modes, the camera takes photographs while the browser shutter-release button is pressed.



## ✔ Focusing

To focus, tap your subject in the viewfinder area.

---

## ■ The Viewer Window

The viewer window can be accessed by selecting **[Viewer]** on the server home page or by tapping the “view” button in the shooting window. The iPhone viewer window offers a choice of thumbnail and full-frame views.

### Thumbnail View

View multiple small (“thumbnail”) images per page. Tap thumbnails to view pictures full frame.

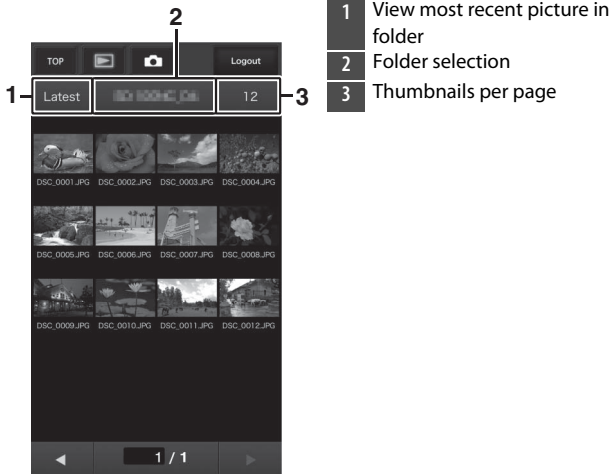

---

## ✔ Voice Memos

Voice memos are listed as separate files.

## ✔ Movies

Movies are indicated by 🎬 icons.

---

## Full-Frame View

Tap thumbnails to display pictures full frame.



- 1 Thumbnail view
- 2 View most recent picture in folder

1

2

## ■ The Text Edit Window

Selecting **[Edit text]** on the server home page displays the text edit window. The text edit window is used to edit the image comments and the copyright and IPTC information stored on the camera.

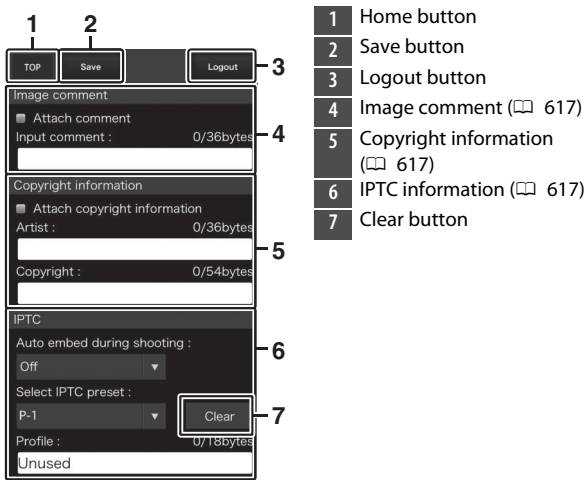

### ✓ Saving Changes

Changes are not saved automatically. Tap the "save" button to save changes.

## Synchronized Release

### About Synchronized Release

Available with D6 and D5 digital cameras, synchronized release groups a master camera with up to ten remote cameras equipped with WT-6 wireless transmitters (available separately) and synchronizes the shutters on the remote cameras with the release on the master camera.

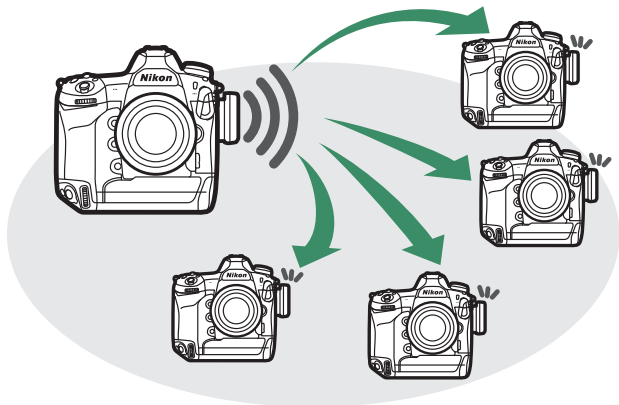



# Using Synchronized Release

Configure all cameras as follows:

- 1 In the setup menu, select [Wired LAN/WT] > [Wired LAN/WT functions] and choose [Enable].**

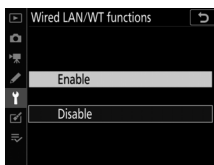

- 2 Select [Choose hardware] > [Wireless LAN].**

The camera will return to the [Wired LAN/WT] display when you press **OK**.



- 3 Select [Network settings], highlight [Synchronized release], and press **OK** (↵).**

The camera will display synchronized release settings.

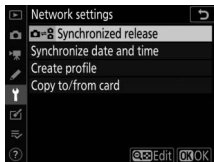

---

## 4 Adjust synchronized release settings.

Configure the master and remote cameras as described below. Press  to return to the previous display when settings are complete.

Option	Description
<b>[Group name]</b>	Enter a group name for the synchronized cameras. Group names can be up to 16 characters long. <ul style="list-style-type: none"><li>• The master and remote cameras must all be in the same group.</li></ul>
<b>[Master/remote]</b>	Choose a role for each camera from “master” and “remote”. <ul style="list-style-type: none"><li>• <b>[Master camera]</b>: Pressing the shutter-release button on the master camera releases the shutters on the remote cameras. Each group can have only one master.</li><li>• <b>[Remote camera]</b>: The shutters on the remote cameras are synchronized with the shutter on the master camera.</li></ul>

Option	Description
<b>[Remote camera check]</b>	Select <b>[On]</b> to check whether the remote cameras are ready. <ul style="list-style-type: none"> <li>• This option is available only if <b>[Master camera]</b> is selected for <b>[Master/remote]</b> on the current camera.</li> <li>• The camera network indicator will flash amber to warn if the number of cameras returning “ready” is less than that selected for <b>[Number of remote cameras]</b>.</li> </ul>
<b>[Number of remote cameras]</b>	Enter the number ( <b>[1]–[10]</b> ) of remote cameras in the group. This option is available only if <b>[On]</b> is selected for <b>[Remote camera check]</b> .

**5 Select [Network settings], highlight [Synchronized release], and press **OK**.**

The camera will connect to the network.

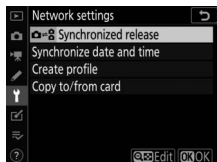

---

## 6 Take pictures.

- Pressing the shutter-release button on the master camera releases the shutters on the remote cameras.

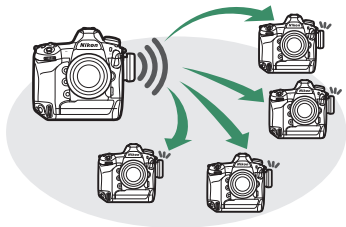

- Note that the standby timers will not expire automatically when the cameras are in synchronized release mode.

---

### ✔ Remote Camera Check

If **[On]** is selected for **[Remote camera check]**, warnings will be displayed if any of the remote cameras are not ready.

---

## Synchronizing Camera Clocks

Synchronize the clocks on two cameras via a network. The clock on one camera (the “remote camera”) is set to the time on the other (the “master camera”). The changes apply to all options in the setup menu **[Time zone and date]** display.

- The cameras can connect via Ethernet or by WT-6 wireless transmitters attached to both cameras.

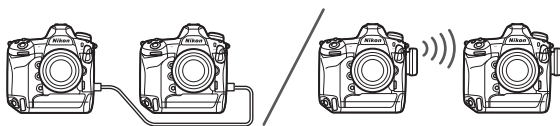

### 1 Select **[Enable]** for **[Wired LAN/WT]** > **[Wired LAN/WT functions]** in the setup menu.

Repeat this step for the second camera.

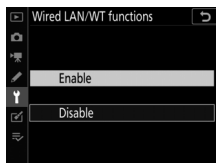

---

**2** On the master camera, select [Network settings] > [Synchronize date and time], then highlight [Make this camera the master] and press .

- Date synchronization mode will be enabled.
- Master camera clock settings will be displayed.

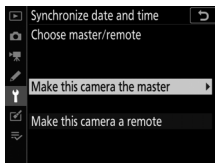

---

**3** On the remote camera, select [Network settings] > [Synchronize date and time], then highlight [Make this camera a remote] and press .

- Date synchronization mode will be enabled.
- Remote camera clock settings will be displayed.

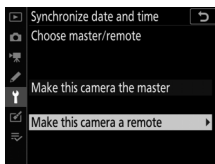

---

#### 4 Press **OK** on the remote camera.

- The remote camera clock will be synchronized with the clock on the master camera via the network.
- If the operation succeeds, the remote camera will display a message and exit to [**Network settings**].
- Repeat Steps 3–4 to synchronize the clocks on additional cameras.

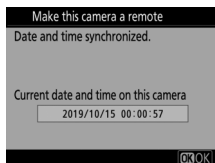

---

#### 5 Press **OK** on the master camera.

Date synchronization mode will end and [**Network settings**] options will be displayed.

# Ethernet/Wireless Transmitter Troubleshooting

Refer to this section for information on errors concerning Ethernet connections or the WT-6.

## **Problems and Solutions**

Solutions to some common issues are listed below.

<b>Problem</b>	<b>Solution</b>
<ul style="list-style-type: none"><li>• The camera displays a wireless error.</li><li>• The camera displays a TCP/IP error.</li><li>• The camera displays an ftp error.</li></ul>	<p>Connection settings require adjustment. Check settings for the wireless router, ftp server, or host computer and adjust camera settings appropriately (☞ 522, 544).</p> <hr/> <p>Check the error code. For more information, see “Error Codes” (☞ 638).</p>



Problem	Solution
"Connecting to PC" does not clear from the camera display.	Check firewall settings (☞ 519).
The camera displays the message, "Ethernet cable is not connected".	Connect an Ethernet cable or select <b>[Wireless LAN]</b> for <b>[Choose hardware]</b> (☞ 520, 521).
The camera displays a "no memory card" error.	The memory card is inserted incorrectly or not at all. Confirm that the memory card is correctly inserted (☞ 38).
Upload is interrupted and fails to resume.	Upload will resume if the camera is turned off and then on again (☞ 592).
No connection is established when the camera URL is entered in a web browser in http server mode.	Confirm that the browser is not using a proxy connection.

## **Error Codes**

The following messages and error codes may be displayed if an error occurs while the camera is connected via Ethernet or using a WT-6.

### ● “[Wireless error.]”

<b>Error code</b>	<b>Solution</b>
Err. 11	Confirm that the device to which you are attempting to connect is on.
	Check the SSID (☐ 941).
Err. 12	Confirm that you are using the correct password for the selected SSID.
	Confirm that you are using the correct authentication method (☐ 941).
Err. 13	Confirm that the device to which you are attempting to connect is on.
	Turn the camera off and then on again.
Err. 1F	Turn the camera off and then on again.

### ● “[TCP/IP error.]”

<b>Error code</b>	<b>Solution</b>
Err. 21	Check that the TCP/IP address and sub-net mask are correct (☐ 944).
Err. 22	Duplicate TCP/IP address. Choose a different address (☐ 944).

● “[PTP/IP error.]”

Error code	Solution
Err. 41	Turn the camera off and then on again.

● “[FTP error.]”

Error code	Solution
Err. 31	Confirm that the ftp server address is correct (☞ 945).
Err. 32	Check that the login name and password are correct (☞ 945).
Err. 34	Check that the destination folder name is correct (☞ 945).
Err. 35	Confirm that the destination folder is not write-protected.
Err. 36	Check the DNS (☞ 944).
Err. 37	Check firewall settings (☞ 519).
	Check PASV mode settings (☞ 945).
Err. 3F	Turn the camera off and then on again.

● “[An HTTP error has occurred.]”

Error code	Solution
Err. 5F	Turn the camera off and then on again.

# On-Camera Flash Photography

## “On-Camera” Versus “Remote”

You can take pictures using an optional flash unit mounted on the camera accessory shoe or one or more remote flash units.

### Camera-Mounted Flash Units

Take pictures using a flash unit mounted on the camera. See the following pages for more information (📖 641).

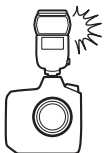

### Remote Flash Photography

Take pictures with one or more remote flash units using wireless flash control (Advanced Wireless Lighting, or AWL). For more information, see “Remote Flash Photography” (📖 663).

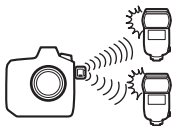

## Using an On-Camera Flash

### 1 Mount a flash unit on the camera accessory shoe.

See the manual provided with the unit for details.

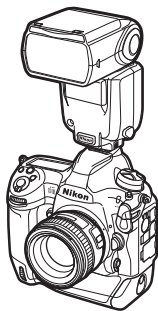

### 2 Turn on the camera and flash unit.

The flash will begin charging; the flash-ready indicator (⚡) will be displayed in the viewfinder when charging is complete.

### 3 Choose the flash control mode (📖 645) and flash mode (📖 131, 648).

---

## 4 Adjust shutter speed and aperture.

---

## 5 Take pictures.

---

### ✓ Shutter Speed

Shutter speed can be set as follows when an optional flash unit is used:

Mode	Shutter speed
<b>P, A</b>	Set automatically by camera ( $1/250$ s– $1/60$ s) *
<b>S</b>	$1/250$ s–30 s
<b>M</b>	$1/250$ s–30 s, <b>Bulb, Time</b>

\* Shutter speed may be set as slow as 30 s if slow sync, slow rear-curtain sync, or slow sync with red-eye reduction is selected for flash mode.

### ✓ Third-Party Flash Units

The camera cannot be used with flash units that would apply voltages over 250 V to the camera's X contacts or short-circuit contacts on the accessory shoe. Use of such flash units could not only interfere with normal operation of the camera but also damage the flash sync circuits of the camera and/or flash.

## ✔ i-TTL Flash Control

When an optional flash unit that supports the Nikon Creative Lighting System is attached and set to TTL, the camera uses monitor pre-flashes for balanced or standard “i-TTL fill-flash” flash control. i-TTL flash control is not available with flash units that do not support the Nikon Creative Lighting System. The camera supports the following types of i-TTL flash control:

Flash Control	Description
<b>i-TTL balanced fill-flash</b>	The camera uses “i-TTL balanced fill-flash” flash control for a natural balance between the main subject and ambient background lighting. After the shutter-release button is pressed and immediately before the main flash, the flash unit emits a series of monitor pre-flashes which the camera uses to optimize flash output for a balance between the main subject and ambient background lighting.
<b>Standard i-TTL fill-flash</b>	Flash output is adjusted to bring lighting in the frame to a standard level; the brightness of the background is not taken into account. Recommended for shots in which the main subject is emphasized at the expense of background details, or when exposure compensation is used.

- Standard i-TTL fill-flash is activated automatically when **[Spot metering]** is selected.

---

### **The Sync Terminal**

A sync cable can be connected to the sync terminal (which features a JIS-B locking nut) as required. Do not connect another flash unit via a sync cable when performing rear-curtain sync flash photography with a flash unit mounted on the camera accessory shoe.





## Flash Control Mode



When a flash unit that supports unified flash control (an SB-5000, SB-500, SB-400, or SB-300) is mounted on the camera, the flash control mode, flash level, and other flash settings can be adjusted using the **[Flash control]** >

**[Flash control mode]** item in the photo shooting menu. The flash control modes available vary with the flash used. The contents of the **[Flash control mode]** display vary with the options selected.

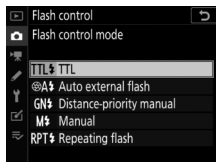
- Settings for units other than the SB-5000, SB-500, SB-400, and SB-300 can only be adjusted via the controls on the flash unit.



- Settings for the SB-5000 can also be adjusted using the controls on the flash unit.

Option	Description
[TTL]	<ul style="list-style-type: none"> <li>• Flash output is adjusted automatically in response to lighting conditions.</li> <li>• Output can be adjusted using <b>[Flash compensation (TTL)]</b>. In the cases of the SB-500, SB-400, and SB-300, flash compensation can be adjusted by holding the  button and rotating the sub-command dial.</li> </ul>
[Auto external flash]	<ul style="list-style-type: none"> <li>• Light from the flash is reflected from the subject to an auto external flash sensor and flash output adjusted automatically.</li> <li>• Output can be adjusted using <b>[Auto external flash compensation]</b>.</li> <li>• Auto external flash supports “auto aperture” (A) and “non-TTL auto” (A) modes. See the flash unit manual for details.</li> </ul>
[Distance-priority manual]	<ul style="list-style-type: none"> <li>• Choose the distance to the subject; flash output will be adjusted automatically.</li> <li>• The distance to the subject is selected using <b>[Distance-priority options] &gt; [Distance]</b>, while flash output can be adjusted using <b>[Flash compensation]</b>.</li> </ul>



Option	Description
[Manual]	<ul style="list-style-type: none"> <li>• Choose the flash level manually.</li> <li>• Flash output is selected using [Manual output amount].</li> </ul>
[Repeating flash]	<ul style="list-style-type: none"> <li>• The flash fires repeatedly while the shutter is open, producing a multiple-exposure effect.</li> <li>• Use [Repeating flash] &gt; [Output] to adjust flash output and [Times] to choose the number of times the unit fires. [Frequency] controls how often the unit fires per second, measured in Hz.</li> <li>• The maximum number of times the flash will fire varies with [Output] and [Frequency]. See the flash unit manual for details.</li> </ul>



### Unified Flash Control



Unified flash control allows the camera and flash unit to share settings. Changes to flash settings made with either the camera or flash unit are reflected on both devices, as are changes made using optional Camera Control Pro 2 software. The flash unit must support unified flash control.

## Flash Modes

The options available vary with the exposure mode.

Option	Description	Available in
 <b>[Fill flash]</b> (front-curtain sync)	This mode is recommended in most situations. In modes <b>P</b> and <b>A</b> , shutter speed will automatically be set to values between $1/250$ s (or $1/8000$ s with Auto FP High-Speed Sync) and $1/60$ s.	<b>P, S, A, M</b>
 <b>[Red-eye reduction]</b>	Use for portraits. The flash fires before the photograph is taken, reducing “red-eye”. <ul style="list-style-type: none"><li>• A flash unit with red-eye reduction is required.</li><li>• The desired results may not be achieved if the subject or camera moves before the shutter is released (this setting is not recommended with moving subjects or in other situations requiring a quick shutter response).</li></ul>	<b>P, S, A, M</b>

Option	Description	Available in
	<p><b>[Slow sync]</b></p> <p>As for “fill flash”, except that shutter speed slows automatically to capture background lighting at night or under low light.</p> <ul style="list-style-type: none"> <li>• Note that photos may be prone to blurring due to camera shake at slow shutter speeds.</li> <li>• Use of a tripod is recommended.</li> </ul>	<p><b>P, A</b></p>
	<p><b>[Slow sync + red-eye]</b> (red-eye reduction with slow sync)</p> <p>Use to include background lighting in portraits. Red-eye reduction is combined with slow shutter speeds to capture background lighting at night or under low light.</p> <ul style="list-style-type: none"> <li>• Note that photos may be prone to blurring due to camera shake at slow shutter speeds.</li> <li>• Use of a tripod is recommended.</li> </ul>	<p><b>P, A</b></p>

Option	Description	Available in
 <b>[Rear-curtain sync]</b>	<p>The flash fires just before the shutter closes, creating the effect of a stream of light behind moving light sources.</p> <ul style="list-style-type: none"> <li>• Selecting mode <b>P</b> or <b>A</b> after choosing this option sets the flash mode to slow sync.</li> <li>• Note that photos may be prone to blurring due to camera shake at slow shutter speeds.</li> <li>• Use of a tripod is recommended.</li> </ul>	<b>P, S, A, M</b>
 <b>[Flash off]</b>	The flash does not fire.	<b>P, S, A, M</b>

### ✔ Studio Strobe Lighting

Rear-curtain sync cannot be used with studio flash systems, as the correct synchronization cannot be obtained.

## Choosing a Flash Mode

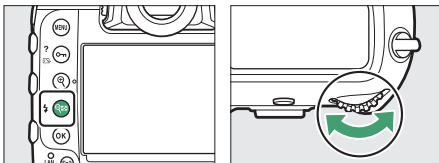

Hold the  button and rotate the main command dial.

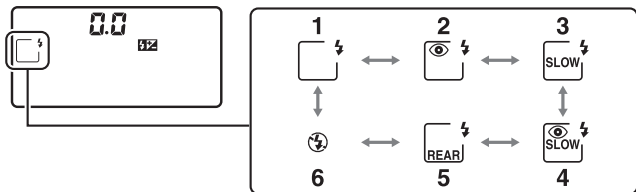

- The selected option is displayed in the top control panel.



- 1 Fill flash
- 2 Red-eye reduction <sup>1</sup>
- 3 Slow sync <sup>2</sup>
- 4 Red-eye reduction with slow sync <sup>1,3</sup>
- 5 Rear-curtain sync <sup>4</sup>
- 6 Flash off

- 1  icon flashes if flash unit does not support red-eye reduction.
- 2 Not available in modes **S** and **M**. Fill flash is selected instead.
- 3 Not available in modes **S** and **M**. Red-eye reduction is selected instead.
- 4 In modes **P** and **A**, slow rear-curtain sync will be selected as shown when the  () button is released.





## Flash Compensation



Flash compensation is used to deliberately alter flash output, for example in order to change the brightness of the subject relative to the background. Flash output can be increased to make the main subject appear brighter, reduced to prevent glare, or otherwise fine-tuned to produce the desired result.

### Adjusting Flash Compensation

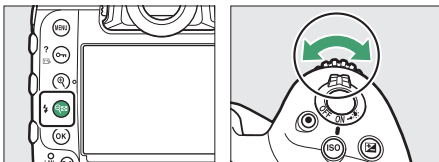
Hold the  (⚡) button and rotate the sub-command dial.



- Choose from values of from  $-3$  to  $+1$ .
- At default settings, changes to flash output are made in increments of  $1/3$  EV. The size of the increment can be selected using Custom Setting b3 [**Exp./flash comp. step value**].

- In general, choose positive values for brighter lighting, negative values to ensure that the subject is not too brightly lit.
- At values other than  $\pm 0.0$ , a  icon will appear in the viewfinder and top control panel.
- Flash compensation can be viewed in the top control panel and viewfinder by pressing the  () button.

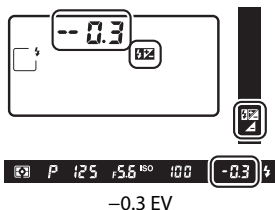

- Normal flash output can be restored by setting flash compensation to  $\pm 0.0$ . Flash compensation is not reset when the camera is turned off.

## FV Lock

This feature is used to lock flash output for CLS-compatible flash units, letting you take multiple photos or recompose shots without changing the flash level. Your subject need not be in the center of the frame, giving you more freedom when composing shots.

- Flash output is adjusted automatically for any changes in ISO sensitivity and aperture.

---

### 1 Assign [FV lock] to a control using Custom Setting f3 [Custom controls].

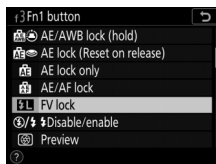

---

### 2 Mount a CLS-compatible flash unit on the camera accessory shoe.

---

### 3 Turn the flash unit on and choose a flash control mode of monitor pre-flash A or A.

- If you are using an SB-5000, SB-500, SB-400, or SB-300 mounted on the camera accessory shoe, choose [TTL] or [Auto external flash] for [Flash control] > [Flash control mode].
- For information on other flash units, see the documentation provided with the unit.

---

### 4 Focus.

Position the subject in the center of the frame and press the shutter-release button halfway to focus.



---

## 5 Lock flash level.

- After confirming that the flash-ready indicator (⚡) appears in the viewfinder, press the **[FV lock]** control; the flash unit will emit a monitor pre-flash to determine the appropriate flash level.
- Flash output will lock and an FV lock icon (🔒) will appear in the viewfinder.



---

## 6 Recompose the shot.

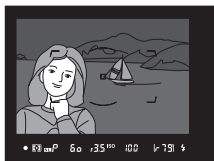

---

## **7 Press the shutter-release button the rest of the way down to shoot.**

If desired, additional pictures can be taken without releasing FV lock. Repeat Steps 6 to 7 to take additional shots.

---

## **8 Release FV lock.**

Press the [**FV lock**] control to release FV lock and confirm that the FV lock icon (**L**) is no longer displayed in the viewfinder.

## Flash Info for On-Camera Units

When a unit that supports unified flash control (the SB-5000, SB-500, SB-400, or SB-300) is mounted on the camera accessory shoe, flash info can be viewed in the camera display. To view flash info during viewfinder photography, press the **Info** button to activate the information display (📖 1026) and then press the **Info** button again.

# Flash Control Mode Displays

## TTL

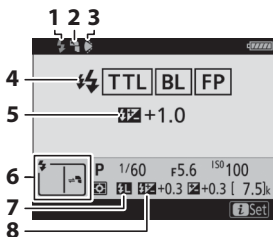

- |   |  |
|---|--|
| 1 | Flash-ready indicator (☞ 641)  |
| 2 | Bounce icon (displayed if flash head is tilted up, left, or right)             |
| 3 | Zoom head position warning (displayed if zoom head is not in correct position) |
| 4 | Flash control mode (☞ 645)<br>FP indicator (☞ 836)                             |
| 5 | TTL flash compensation (☞ 645)   |
| 6 | Flash mode (☞ 131, 648)  |
| 7 | FV lock indicator (☞ 655)  |
| 8 | Flash compensation (☞ 133, 653)  |



## ■ Auto External Flash

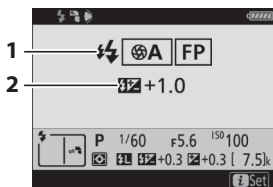

- 1 Flash control mode (☞ 645)  
FP indicator (☞ 836)
- 2 Auto external flash compensation (☞ 645)

## ■ Distance-Priority Manual

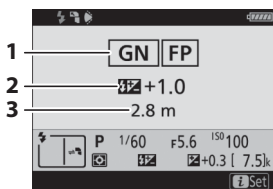

- 1 Flash control mode (☞ 645)  
FP indicator (☞ 836)
- 2 Distance-priority manual flash compensation (☞ 645)
- 3 Distance (☞ 645)

## ■ Manual

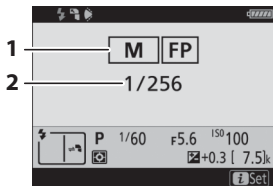

- 1 Flash control mode (☞ 645)  
FP indicator (☞ 836)
- 2 Flash level (☞ 645)

## ■ Repeating Flash

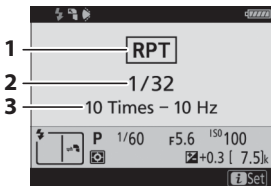

- 1 Flash control mode (📖 645)
- 2 Output (📖 645)
- 3 Times (📖 645)  
Frequency (📖 645)

## ✓ Flash Info and Camera Settings

The flash information display shows select camera settings, including exposure mode, shutter speed, aperture, and ISO sensitivity.

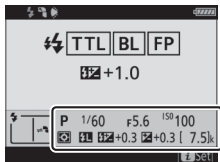

## ✓ Changing Flash Settings

Flash settings can be changed by pressing the **i** button in the flash info display. The options available vary with the flash unit and the settings selected. You can also test-fire the flash.

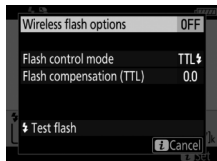

# Remote Flash Photography

## What Is Remote Flash Photography?

Take pictures with one or more remote flash units using wireless flash control (Advanced Wireless Lighting, or AWL). For information on using a flash unit mounted on the camera accessory shoe, see “On-Camera Flash Photography” (📖 640).

Throughout this chapter, operations involving an accessory connected to the camera are indicated by 📷, operations involving remote flash units by 📷. For more information on using remote flash units (📷), see the manual provided with the flash unit.

## Using Remote Flash Units

Remote flash units can be controlled via:

- radio signals \* (📖 665),
- optical signals from a flash unit mounted on the camera accessory shoe (📖 680),
- radio signals, with additional lighting provided by a shoe-mounted flash unit \* (📖 679), or
- combined radio and optical signals \* (📖 694).

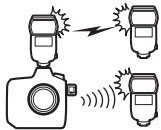
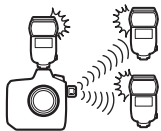
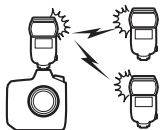
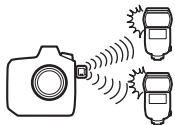

\* Radio flash control is available only when a WR-R10 is connected to the camera.

## Radio AWL

Remote flash control provided via radio signals from a WR-R10 connected to the camera is termed “radio Advanced Wireless Lighting”, or “radio AWL”. Radio AWL is available with SB-5000 flash units.

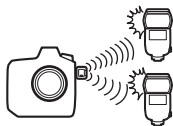

### **Establishing a Wireless Connection**

Before using radio AWL, establish a wireless connection between the WR-R10 and the remote flash units.

---

#### **1 : Connect the WR-R10.**

For more information, see the documentation provided with the WR-R10.

## 2 : Select [Radio AWL] for [Flash control] > [Wireless flash options] in the photo shooting menu.

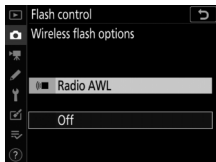

### **The WR-R10 Wireless Remote Controller**

- A WR-A10 adapter is required when using the WR-R10.
- Be sure to update the firmware for the optional WR-R10 wireless remote controller to version 3.0 or later before using radio AWL. For information on firmware updates, see the Nikon website for your area.

## 3 : Choose a channel for the WR-R10.

Set the WR-R10 channel selector to the desired channel.

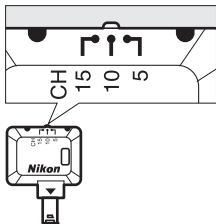

## 4 : Choose a link mode for the WR-R10.

Select **[Wireless remote (WR) options]** > **[Link mode]** in the camera setup menu and choose from the following options:

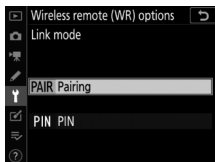

Option	Description
<b>[Pairing]</b>	<p>The camera connects only to devices with which it has previously been paired.</p> <ul style="list-style-type: none"><li>• This prevents signal interference from other devices in the vicinity.</li><li>• Given that each device must be paired separately, PIN is recommended when connecting to a large number of devices.</li></ul>
<b>[PIN]</b>	<p>Communication is shared among all devices with the same four-digit PIN.</p> <ul style="list-style-type: none"><li>• This is therefore a good choice for photography featuring a large number of remote devices.</li><li>• If there are multiple cameras present that share the same PIN, the flash units will be under the sole control of the camera that connects first, preventing all other cameras from connecting (the LEDs on the WR-R10 units connected to the affected cameras will blink).</li></ul>

---

## **5** : Establish a wireless connection between the WR-R10 and the remote flash units.

- Set the remote units to radio AWL remote mode.
- Set the remote units to the channel you selected for the WR-R10 in Step 3.
- Pair each of the remote units with the WR-R10 according to the option selected in Step 4:
  - **[Pairing]**: Initiate pairing on the remote unit and press the WR-R10 pairing button. Pairing is complete when the LINK lamps on the WR-R10 and flash unit flash orange and green. Once a connection is established, the LINK lamp on the remote flash unit will light green.
  - **[PIN]**: Use the controls on the remote flash unit to enter the PIN you selected in the previous step. Pairing begins when the PIN is entered. Once a connection is established, the LINK lamp on the remote flash unit will light green.

---

## **6** : Repeat Step 5 for the remaining remote units.



## 7 : Confirm that the flash-ready lights for all flash units are lit.

In radio AWL, the flash-ready indicator will light in the camera viewfinder or flash information display when all flash units are ready.

### Listing Remote Flash Units

To view the flash units currently controlled using radio AWL, select [**Flash control**] > [**Radio remote flash info**] in the camera photo shooting menu.

- The identifier (remote flash unit name) for each unit can be changed using flash unit controls.

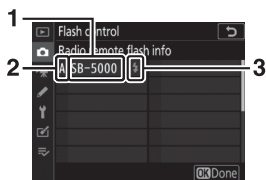

- 1 Connected flash unit
- 2 Group
- 3 Flash-ready indicator

### Reconnecting

As long as the channel, link mode, and other settings remain the same, the WR-R10 will automatically connect to previously paired flash units when you select remote mode, and Steps 3–6 can be omitted. The flash unit LINK lamp lights green when a connection is established.

## Remote Flash Photography

Settings are adjusted using **[Flash control]** > **[Remote flash control]** in the photo shooting menu. Choose a remote flash control mode and take pictures as described below.

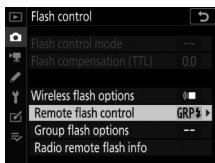

### ■ Group Flash

Select this item if you want to adjust settings separately for the flash units in each group.

- 1** : Select **[Group flash]** for **[Flash control]** > **[Remote flash control]**.

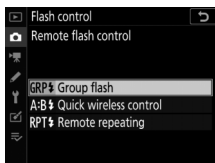

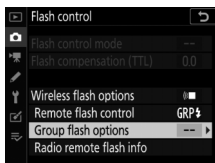

- 2** : Highlight **[Group flash options]** in the **[Flash control]** display and press .

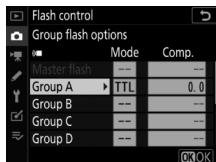

### 3 : Choose a flash control mode and flash level.

- Choose a flash control mode and flash level for the flash units in each group.
- The following options are available:



Option	Description
<b>TTL</b>	i-TTL flash control.
 <b>A</b>	Auto aperture. Available only with compatible flash units.
<b>M</b>	Choose the flash level manually.
<b>-- (off)</b>	The remote units do not fire. [ <b>Comp.</b> ] cannot be adjusted.

### 4 : Group the remote flash units.

- Choose a group (A–F) for each of the remote flash units.
- The master flash can control up to 18 flash units in any combination.

---

## 5 : Compose the shot and arrange the flash units.

- See the documentation provided with the flash units for more information.
- Test-fire the units and confirm that they are functioning normally. To test-fire the units, press the **i** button in the flash info display, highlight [**⚡ Test flash**], and press **OK** ( 697).

---

## 6 : Take the photograph.

## ■ Quick Wireless Control

Select this item to control the relative balance between the remote flash units in groups A and B and adjust flash output for group C. Output for group C is adjusted manually.

- 1** : Select [Quick wireless control] for [Flash control] > [Remote flash control].

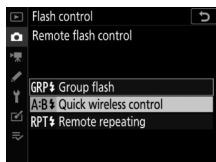

- 2** : Highlight [Quick wireless control options] in the [Flash control] display and press .

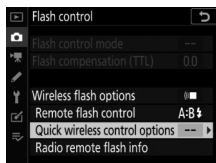

### 3 Adjust quick wireless control settings.

- Choose the balance between groups A and B.

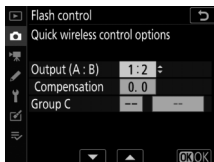

- Adjust flash compensation for groups A and B.

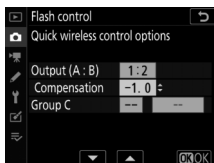

- Adjust settings for group C:
  - Select [M] to enable or [---] to disable the units in group C.
  - When [M] is selected, the units in group C will fire at the chosen output.

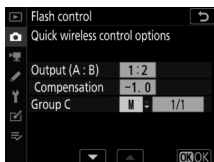

---

## 4 : Group the remote flash units.

- Choose a group (A, B, or C).
- The master flash can control up to 18 flash units in any combination.

---

## 5 / : Compose the shot and arrange the flash units.

- See the documentation provided with the flash units for more information.
- Test-fire the units and confirm that they are functioning normally. To test-fire the units, press the **i** button in the flash info display, highlight [**⚡ Test flash**], and press **OK** ( 697).

---

## 6 : Take the photograph.

## ■ Remote Repeating

The flash units fire repeatedly while the shutter is open, producing a multiple-exposure effect.

- 1 : Select [Remote repeating] for [Flash control] > [Remote flash control].

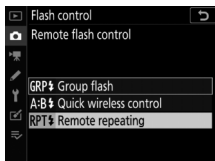

- 2 : Highlight [Remote repeating options] in the [Flash control] display and press .

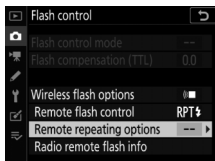



---

### 3 : Adjust remote repeating options.

- Adjust “output”, “times”, and “frequency”.

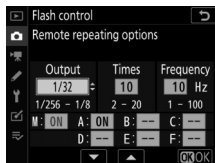

- **Enable or disable selected groups.**

- Select  [ON] to enable the selected group,  [---] to disable the selected group.

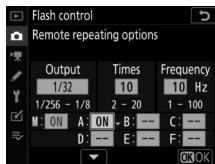

---

### 4 : Group the remote flash units.

- Choose a group (A–F) for each of the remote flash units.
- The master flash can control up to 18 flash units in any combination.

---

## 5 : Compose the shot and arrange the flash units.

- See the documentation provided with the flash units for more information.
- Test-fire the units and confirm that they are functioning normally. To test-fire the units, press the **i** button in the flash info display, highlight [**⚡ Test flash**], and press **OK** ( 697).

---

## 6 : Take the photograph.

## Adding a Shoe-Mounted Flash Unit

Radio-controlled flash units (📖 665) can be combined with any of the following flash units mounted on the camera accessory shoe:

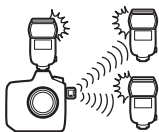

- SB-5000: Before attaching the flash unit, set it to radio-controlled master flash mode (a 📶 icon will appear at the top left corner of the display) and choose group or remote-repeating flash control. Once the unit is attached, settings can be adjusted from the camera menus or using the controls on the SB-5000. In the case of the camera menus, use the options listed under [**Group flash options**] > [**Master flash**] or under [**M**] in the [**Remote repeating options**] display.
- SB-910, SB-900, SB-800, SB-700, SB-600: Configure the flash for standalone use. Use the controls on the flash unit to adjust flash settings.
- SB-500, SB-400, SB-300: Mount the unit on the camera. Adjust settings using the [**Group flash options**] > [**Master flash**] item in the camera menus.

## Optical AWL

Remote flash units can be controlled via optical signals from an optional flash unit mounted on the camera accessory shoe and functioning as a master flash (optical AWL). For information on compatible flash units, see “The Nikon Creative Lighting System (CLS)” (📖 1051).

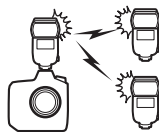

- If the flash unit in question is an SB-5000 or SB-500, settings can be adjusted from the camera. For more information, see “Using Optical AWL with the SB-5000 or SB-500” (📖 681). For information on flash placement and other topics, see the documentation provided with the flash units.
- Settings for other flash units must be adjusted using flash unit controls. For more information, see the documentation provided with the flash unit in question.

## Using Optical AWL with the SB-5000 or SB-500

Mount the flash unit on the camera accessory shoe. Select [**Optical AWL**] for [**Flash control**] > [**Wireless flash options**] in the photo shooting menu and choose a remote flash control mode (the SB-500 supports only [**Group flash**]). Choose a remote flash control mode and take pictures as described below.



---

### ✓ The SB-5000

When an SB-5000 is mounted on the camera accessory shoe, [**Flash control**] settings can also be changed using the controls on the flash unit.

---

## ■ Group Flash

Select this item if you want to adjust settings separately for the flash units in each group.

- 1** : Select [Group flash] for [Flash control] > [Remote flash control].

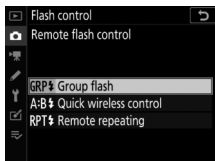

- 2** : Highlight [Group flash options] in the [Flash control] display and press .

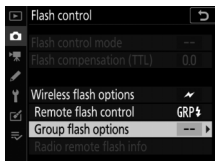

### 3 : Adjust flash output and choose the channel and flash control mode.

- Choose the flash control mode and flash level for the master flash and the remote flash units in each group.
- The following options are available:

Option	Description
TTL	i-TTL flash control.
 A	Auto aperture. Available only with compatible flash units.
M	Choose the flash level manually.
-- (off)	The remote units do not fire. [Comp.] cannot be adjusted.

- For [Channel], choose the channel (1–4) the master flash will use for optical remote flash control.
- If the remote flash units include an SB-500, you must choose channel [3].

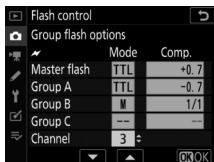
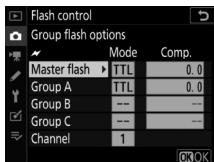

---

#### 4 : Choose a channel for the remote flash units.



Set the remote flash units to the channel selected for [Channel] in Step 3.

---

#### 5 : Group the remote flash units.

- Choose a group (A, B, or C).
  - If you are using an SB-500 as the master flash, choose from groups A and B.
  - There is no limit on the number of remote flash units that may be used. The practical maximum, however, is three per group, as the light emitted by the remote flash units will interfere with performance if more flash units are used.
- 

#### 6 /: Compose the shot and arrange the flash units.

- See the documentation provided with the flash units for more information.
- Test-fire the units and confirm that they are functioning normally. To test-fire the units, press the test button on the master flash or press the  button in the flash info display and select [ Test flash] ( 697).



---

**7**  : Take the photograph after confirming that the flash-ready lights for all flash units are lit.

## ■ Quick Wireless Control (SB-5000 Only)

Select this item to control the relative balance between the remote flash units in groups A and B and adjust flash output for group C. Output for group C is adjusted manually.

- 1** : Select [Quick wireless control] for [Flash control] > [Remote flash control].

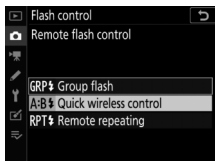

- 2** : Highlight [Quick wireless control options] in the [Flash control] display and press .

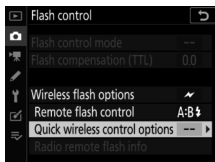

### 3 : Adjust quick wireless control settings.

- Choose the balance between groups A and B.

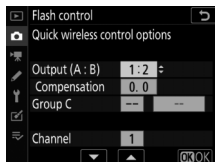

- Adjust flash compensation for groups A and B.

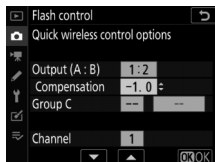

- Adjust settings for group C:

- Select [M] to enable or [---] to disable the units in group C.
- When [M] is selected, the units in group C will fire at the chosen output.

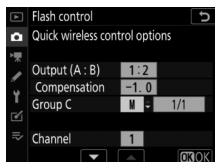

- **Choose the channel.**

- For **[Channel]**, choose the channel (1–4) the master flash will use for optical remote flash control.
- If the remote flash units include an SB-500, you must choose channel **[3]**.

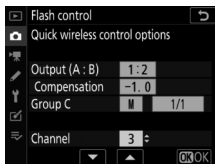

---

#### **4** **Choose a channel for the remote flash units.**

Set the remote flash units to the channel selected for **[Channel]** in Step 3.

---

#### **5** **Group the remote flash units.**

- Choose a group (A, B, or C).
- There is no limit on the number of remote flash units that may be used. The practical maximum, however, is three per group, as the light emitted by the remote flash units will interfere with performance if more flash units are used.

---

## **6** : **Compose the shot and arrange the flash units.**

- See the documentation provided with the flash units for more information.
- Test-fire the units and confirm that they are functioning normally. To test-fire the units, press the test button on the master flash or press the **i** button in the flash info display and select [**⚡ Test flash**] (📖 697).

---

## **7** : **Take the photograph after confirming that the flash-ready lights for all flash units are lit.**

## ■ Remote Repeating (SB-5000 Only)

The flash units fire repeatedly while the shutter is open, producing a multiple-exposure effect.

- 1** : Select [Remote repeating] for [Flash control] > [Remote flash control].

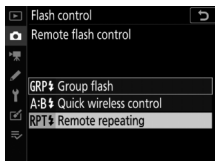

- 2** : Highlight [Remote repeating options] in the [Flash control] display and press .

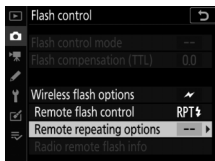

### 3 : Adjust remote repeating options.

- Adjust “output”, “times”, and “frequency”.

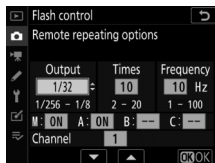

- Enable or disable selected groups.

- Select [ON] to enable the selected group, [---] to disable the selected group.

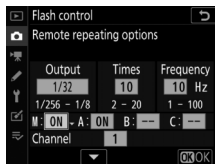

- Choose the channel.

- For [Channel], choose the channel (1–4) the master flash will use for optical remote flash control.

- If the remote flash units include an SB-500, you must choose channel [3].

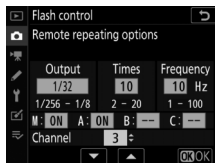

---

#### 4 : Choose a channel for the remote flash units.

Set the remote flash units to the channel selected for [Channel] in Step 3.

---

#### 5 : Group the remote flash units.

- Choose a group (A, B, or C).
  - There is no limit on the number of remote flash units that may be used. The practical maximum, however, is three per group, as the light emitted by the remote flash units will interfere with performance if more flash units are used.
- 

#### 6 / : Compose the shot and arrange the flash units.

- See the documentation provided with the flash units for more information.
- Test-fire the units and confirm that they are functioning normally. To test-fire the units, press the test button on the master flash or press the **i** button in the flash info display and select [**⚡ Test flash**] ( 697).



---

## 7 : Take the photograph after confirming that the flash-ready lights for all flash units are lit.

---



### **Optical AWL**

- Position the sensor windows on the remote flash units to pick up the light from the master flash. Particular care is required if the master flash is mounted on a hand-held camera.
  - Be sure that direct light or strong reflections from the remote flash units do not enter the camera lens (in [TTL] mode) or the photocells on the remote flash units ([A] mode). Otherwise light from the flash units may interfere with exposure.
  - Even if [–] is selected for [Master flash] > [Mode], the master flash may emit low-intensity timing flashes. These flashes may appear in photographs taken at short range. This can be prevented by choosing low ISO sensitivities or small apertures (high f-numbers).
  - After positioning the remote flash units, take a test shot and view the results in the camera display.
-

## Optical/Radio AWL

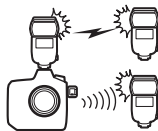
For simultaneous optical and radio AWL, attach a WR-R10 and mount an SU-800 or a master flash that supports optical flash control (the SB-910, SB-900, SB-800, SB-700, or SB-500) on the accessory shoe.



- Establish connections between the WR-R10 and all radio-controlled flash units (☞ 665).
- If an SB-500 is mounted on the camera accessory shoe, select [**Optical/radio AWL**] for [**Wireless flash options**]. With other flash units or the SU-800, [**Wireless flash options**] is set to [**Optical/radio AWL**] automatically.
- The only option available for [**Remote flash control**] will be [**Group flash**].
- The remote flash units can be placed in up to six groups (A through F). Place optically-controlled units in groups A through C and radio-controlled units in groups D through F. To display options for groups D through F, press  or  in the [**Group flash options**] display.

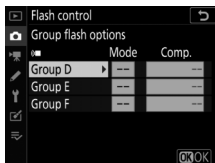

## Flash Info for Remote Units

The camera can display flash info for a SB-5000 or SB-500 flash unit mounted on the camera accessory shoe and configured as a master flash for optical AWL, as well as for remote flash units controlled via radio AWL using a WR-R10. To view flash info during viewfinder photography, press the **info** button to activate the information display (☞ 1026) and then press the **info** button again.

## Flash Control Mode Displays

### ■ Group Flash

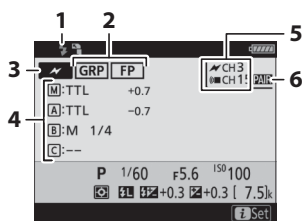

- 1 Flash-ready indicator <sup>1</sup>
- 2 Remote flash control (☞ 777)  
FP indicator (☞ 836)
- 3 Remote flash control mode <sup>2</sup>  
(☞ 776)
- 4 Group flash control mode <sup>3</sup>  
Group flash mode (☞ 670,  
682)  
Flash compensation/flash  
level (output; ☞ 670, 682)
- 5 Channel <sup>2</sup> (☞ 665, 682)
- 6 Link mode <sup>4</sup> (☞ 926)

## Quick Wireless Control

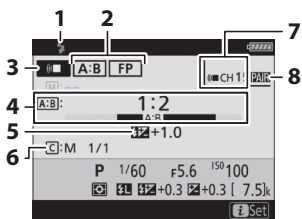

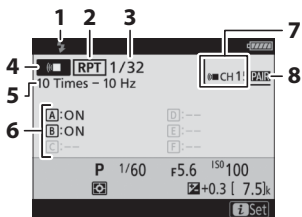

- 1 Flash-ready indicator <sup>1</sup>
- 2 Remote flash control (☐ 777)  
FP indicator (☐ 836)
- 3 Remote flash control mode <sup>2</sup>  
(☐ 776)
- 4 A:B ratio (☐ 673, 686)
- 5 Flash compensation (☐ 673,  
686)
- 6 Group C flash control mode  
and flash level (output; ☐ 673,  
686)
- 7 Channel <sup>2</sup> (☐ 665, 686)
- 8 Link mode <sup>4</sup> (☐ 926)

## Remote Repeating



- 1 Flash-ready indicator <sup>1</sup>
- 2 Remote flash control (☐ 777)
- 3 Output (☐ 676, 690)
- 4 Remote flash control mode <sup>2</sup>  
(☐ 776)
- 5 Times (☐ 676, 690)  
Frequency (☐ 676, 690)
- 6 Group status (enabled/  
disabled; ☐ 676, 690)
- 7 Channel <sup>2</sup> (☐ 665, 690)
- 8 Link mode <sup>4</sup> (☐ 926)

- 1 Displayed in radio AWL when all flash units are ready.
- 2 Optical AWL is indicated by , radio AWL by , joint optical and radio AWL by both icons together. Optical AWL channel for joint optical and radio AWL is displayed only when SB-500 is used as master flash.
- 3 Icons are displayed for each group only when joint optical and radio AWL is used.
- 4 Displayed only when radio AWL or joint optical and radio AWL is used.

## ✓ Flash Info and Camera Settings

The flash information display shows select camera settings, including exposure mode, shutter speed, aperture, and ISO sensitivity.

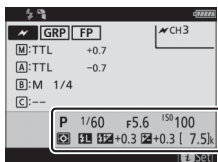

## ✓ The *i* Button

Flash settings can be changed by pressing the *i* button in the flash info display. The options available vary with the flash unit and the settings selected. You can also test-fire the flash.

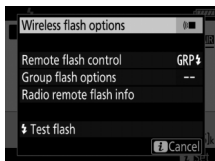

# Menu Guide

## Defaults

The defaults for the playback, photo shooting, movie shooting, Custom Settings, and setup menus are listed below.

### Playback Menu Defaults

Playback menu option	Default
[Delete]	—
[Playback folder]	All
<b>[Playback display options]</b>	
[Focus point]	<input type="checkbox"/>
[Exposure info]	<input type="checkbox"/>
[Highlights]	<input type="checkbox"/>
[RGB histogram]	<input type="checkbox"/>
[Shooting data]	<input type="checkbox"/>
[Overview]	<input type="checkbox"/>
[None (image only)]	<input type="checkbox"/>
[Basic shooting data]	<input checked="" type="checkbox"/>
[Flash data]	<input checked="" type="checkbox"/>
[Picture Control data]	<input checked="" type="checkbox"/>
[Other shooting data]	<input checked="" type="checkbox"/>
[Copyright info]	<input checked="" type="checkbox"/>
[Location data]	<input checked="" type="checkbox"/>
[IPTC data]	<input checked="" type="checkbox"/>

<b>Playback menu option</b>	<b>Default</b>
<b>[Delete images from both slots]</b>	Yes (confirmation required)
<b>[Dual-format recording PB slot]</b>	Slot 1
<b>[Filtered playback criteria]</b>	
<b>[Protect]</b>	<input type="checkbox"/>
<b>[Rating]</b>	<input type="checkbox"/>
<b>[Select to send (wired LAN/WT)]</b>	<input type="checkbox"/>
<b>[Image review]</b>	Off
<b>[After delete]</b>	Show next
<b>[After burst, show]</b>	Last image in burst
<b>[Rotate tall]</b>	On
<b>[Copy image(s)]</b>	—
<b>[Hide image]</b>	—
<b>[Slide show]</b>	
<b>[Image type]</b>	Still images and movies
<b>[Frame interval]</b>	2 s

## **Photo Shooting Menu Defaults**

<b>Photo shooting menu option</b>	<b>Default</b>
[Photo shooting menu bank]	A
[Extended photo menu banks]	Off
<b>[Storage folder]</b>	
[Rename]	NC_D6
[Select folder by number]	100
[Select folder from list]	—
<b>[File naming]</b>	DSC
<b>[Role played by card in Slot 2]</b>	Overflow
<b>[Image area]</b>	
[Choose image area]	FX (36×24)
[Auto DX crop]	On
<b>[Image quality]</b>	JPEG normal
<b>[Image size]</b>	
[JPEG]	Large
[NEF (RAW)]	Large



Photo shooting menu option	Default
<b>[NEF (RAW) recording]</b>	
[NEF (RAW) compression]	Lossless compressed
[NEF (RAW) bit depth]	14-bit
<b>[ISO sensitivity settings]</b>	
[ISO sensitivity]	100
[Auto ISO sensitivity control]	Off
[Maximum sensitivity]	102400
[Maximum sensitivity with 	Same as without flash
[Minimum shutter speed]	Auto
<b>[White balance]</b>	Auto: Keep white (reduce warm colors)
[Fine-tune]	A-B: 0, G-M: 0
[Choose color temperature]	5000K
[Preset manual]	d-1
<b>[Set Picture Control]</b>	Auto
<b>[Manage Picture Control]</b>	—
<b>[Color space]</b>	sRGB
<b>[Active D-Lighting]</b>	Off
<b>[Long exposure NR]</b>	Off

<b>Photo shooting menu option</b>	<b>Default</b>
[High ISO NR]	Normal
[Vignette control]	Normal
[Diffraction compensation]	On
[Auto distortion control]	Off
<b>[Flicker reduction]</b>	
[Flicker reduction setting]	Disable
[Flicker reduction indicator]	On
<b>[Flash control]</b>	
[Flash control mode]	TTL
[Wireless flash options]	Off
[Remote flash control]	Group Flash
<b>[Auto bracketing]</b>	
[Auto bracketing set]	AE & flash bracketing
[Number of shots]	0F
[Increment]	1.0

<b>Photo shooting menu option</b>	<b>Default</b>
<b>[Multiple exposure]</b>	
[Multiple exposure mode]	Off
[Number of shots]	2
[Overlay mode]	Average
[Save individual images (NEF)]	On
[Overlay shooting]	On
[Select first exposure (NEF)]	—
<b>[HDR (high dynamic range)]</b>	
[HDR mode]	Off
[Exposure differential]	Auto
[Smoothing]	Normal
[Save individual images (NEF)]	Off

<b>Photo shooting menu option</b>	<b>Default</b>
<b>[Interval timer shooting]</b>	
<b>[Choose start day/time]</b>	Now
<b>[Interval]</b>	1 min
<b>[Intervals×shots/interval]</b>	0001×1
<b>[Exposure smoothing]</b>	On
<b>[Silent photography]</b>	On
<b>[Interval priority]</b>	Off
<b>[Focus before each shot]</b>	Off
<b>[Options]</b>	Off
<b>[Starting storage folder]</b>	
<b>[New folder]</b>	<input type="checkbox"/>
<b>[Reset file numbering]</b>	<input type="checkbox"/>

<b>Photo shooting menu option</b>	<b>Default</b>
<b>[Time-lapse movie]</b>	
<b>[Interval]</b>	5 s
<b>[Shooting time]</b>	25 min
<b>[Exposure smoothing]</b>	On
<b>[Silent photography]</b>	On
<b>[Image area]</b>	
<b>[Choose image area]</b>	FX
<b>[Auto DX crop]</b>	On
<b>[Frame size/frame rate]</b>	1920x1080; 60p
<b>[Interval priority]</b>	Off
<b>[Focus before each shot]</b>	Off
<b>[Destination]</b>	Slot 1

<b>Photo shooting menu option</b>	<b>Default</b>
<b>[Focus shift shooting]</b>	
[No. of shots]	100
[Focus step width]	5
[Interval until next shot]	0
[First-frame exposure lock]	On
[Silent photography]	On
<b>[Starting storage folder]</b>	
[New folder]	<input type="checkbox"/>
[Reset file numbering]	<input type="checkbox"/>
<b>[Silent live view photography]</b>	Off

## **Movie Shooting Menu Defaults**

<b>Movie shooting menu option</b>	<b>Default</b>
[Reset movie shooting menu]	—
[File naming]	DSC
[Destination]	Slot 1
[Image area]	
[Choose image area]	FX
[Auto DX crop]	On
[Frame size/frame rate]	1920x1080; 60p
[Movie quality]	High quality
[Movie file type]	MOV
[ISO sensitivity settings]	
[Maximum sensitivity]	102400
[Auto ISO control (mode M)]	Off
[ISO sensitivity (mode M)]	100
[White balance]	Same as photo settings
[Fine-tune]	A-B: 0, G-M: 0
[Choose color temperature]	5000K
[Preset manual]	d-1

<b>Movie shooting menu option</b>	<b>Default</b>
[Set Picture Control]	Same as photo settings
[Manage Picture Control]	—
[Active D-Lighting]	Off
[High ISO NR]	Normal
[Diffraction compensation]	On
[Flicker reduction]	Auto
[Electronic VR]	Off
[Microphone sensitivity]	Auto
[Attenuator]	Disable
[Frequency response]	Wide range
[Wind noise reduction]	Off
[Headphone volume]	15
[Timecode]	
[Record timecodes]	Off
[Count-up method]	Record run
[Timecode origin]	—
[Drop frame]	On



## Custom Settings Menu Defaults

	Custom Settings menu option	Default
	[Custom settings bank]	A
a1	[AF-C priority selection]	Release
a2	[AF-S priority selection]	Focus
a3	[Focus tracking with lock-on]	
	[Blocked shot AF response]	3
	[Subject motion]	Steady
a4	[Focus points used]	105 points
a5	[Store points by orientation]	Off
a6	[AF activation]	Shutter/AF-ON
	[Out-of-focus release]	Enable
a7	[Single-point AF watch area]	Normal
a8	[3D-tracking face-detection]	On
a9	[Group-area AF face detection]	On
a10	[Custom groupings (C1/C2)]	
	[Group-area AF (C1)]	15×1
	[Group-area AF (C2)]	15×1
a11	[Auto-area AF face detection]	On

	<b>Custom Settings menu option</b>	<b>Default</b>
a12	[Auto-area AF starting point]	Disable
a13	[Focus point persistence]	Auto
a14	[Limit AF-area mode selection]	
	[Single-point AF]	<input checked="" type="checkbox"/> (fixed)
	[Dynamic-area AF (9 points)]	<input checked="" type="checkbox"/>
	[Dynamic-area AF (25 points)]	<input checked="" type="checkbox"/>
	[Dynamic-area AF (49 points)]	<input checked="" type="checkbox"/>
	[Dynamic-area AF (105 points)]	<input checked="" type="checkbox"/>
	[3D-tracking]	<input checked="" type="checkbox"/>
	[Group-area AF]	<input checked="" type="checkbox"/>
	[Group-area AF (C1)]	<input checked="" type="checkbox"/>
	[Group-area AF (C2)]	<input checked="" type="checkbox"/>
	[Auto-area AF]	<input checked="" type="checkbox"/>
a15	[Autofocus mode restrictions]	No restrictions
a16	[Focus point wrap-around]	No wrap
a17	[Focus point options]	
	[Manual focus mode]	On
	[Focus point brightness]	Normal
	[Dynamic-area AF assist]	On

	<b>Custom Settings menu option</b>	<b>Default</b>
a18	[Manual focus ring in AF mode]	Enable
b1	[ISO sensitivity step value]	1/3 step
b2	[EV steps for exposure cntrl]	1/3 step
b3	[Exp./flash comp. step value]	1/3 step
b4	[Easy exposure compensation]	Off
b5	[Matrix metering]	Face detection on
b6	[Center-weighted area]	φ12 mm
b7	[Fine-tune optimal exposure]	
	[Matrix metering]	0
	[Center-weighted metering]	0
	[Spot metering]	0
	[Highlight-weighted metering]	0
c1	[Shutter-release button AE-L]	Off
c2	[Standby timer]	6 s
c3	[Self-timer]	
	[Self-timer delay]	10 s
	[Number of shots]	1
	[Interval between shots]	0.5 s

	<b>Custom Settings menu option</b>	<b>Default</b>
c4	<b>[Monitor off delay]</b>	
	[Playback]	10 s
	[Menus]	1 min
	[Information display]	10 s
	[Image review]	4 s
	[Live view]	10 min
d1	<b>[Continuous shooting speed]</b>	
	[Continuous high-speed]	14 fps
	[Continuous low-speed]	5 fps
	[Quiet shutter release]	Single frame
d2	<b>[Max. continuous release]</b>	200
d3	<b>[Limit release mode selection]</b>	
	[Single frame]	<input checked="" type="checkbox"/> (fixed)
	[Continuous L]	<input checked="" type="checkbox"/>
	[Continuous H]	<input checked="" type="checkbox"/>
	[Quiet shutter release]	<input checked="" type="checkbox"/>
	[Self-timer]	<input checked="" type="checkbox"/>
	[Mirror up]	<input checked="" type="checkbox"/>

	<b>Custom Settings menu option</b>	<b>Default</b>
d4	[Sync. release mode options]	Sync
d5	[Exposure delay mode]	Off
d6	[Electronic front-curtain shutter]	Disable
d7	[Extended shutter speeds (M)]	Off
d8	[Limit selectable image area]	
	[FX (36x24)]	<input checked="" type="checkbox"/> (fixed)
	[1.2x (30x20)]	<input checked="" type="checkbox"/>
	[DX (24x16)]	<input checked="" type="checkbox"/>
	[5:4 (30x24)]	<input checked="" type="checkbox"/>
	[1:1 (24x24)]	<input checked="" type="checkbox"/>
	[16:9 (36x20)]	<input checked="" type="checkbox"/>
d9	[File number sequence]	On
d10	[Peaking highlights]	
	[Peaking level]	Off
	[Peaking highlight color]	Red
d11	[Framing grid display]	Off
d12	[Rear control panel]	Release mode
d13	[LCD illumination]	Off

	<b>Custom Settings menu option</b>	<b>Default</b>
d14	[ <b>Live view in continuous mode</b> ]	On
d15	[ <b>Optical VR</b> ]	On
e1	[ <b>Flash sync speed</b> ]	1/250 s
e2	[ <b>Flash shutter speed</b> ]	1/60 s
e3	[ <b>Exposure comp. for flash</b> ]	Entire frame
e4	[ <b>Auto <math>\downarrow</math> ISO sensitivity control</b> ]	Subject and background
e5	[ <b>Flash burst priority</b> ]	Prioritize precise flash control
e6	[ <b>Modeling flash</b> ]	On
e7	[ <b>Auto bracketing (mode M)</b> ]	Flash/speed
e8	[ <b>Bracketing order</b> ]	MTR > under > over
e9	[ <b>Bracketing burst options</b> ]	Disable

	Custom Settings menu option	Default
f1	[Customize  menu]	Set Picture Control, Color space, Photo shooting menu bank, Select custom settings bank, Flash mode, Metering, Wired LAN/WT, Active D-Lighting, Autofocus mode, AF-area mode, Focus tracking with lock-on, Custom controls

<b>Custom Settings menu option</b>		<b>Default</b>
f2	[Customize  menu (Lv)]	Set Picture Control, Color space, Peaking highlights, Split-screen display zoom, Flash mode, Metering, Wired LAN/WT, Active D-Lighting, Autofocus mode, AF-area mode, Photo live view display WB, Custom controls



Custom Settings menu option		Default
f3	[Custom controls]	
	[Preview button]	Preview
	[Fn1 button]	Choose image area
	[Fn2 button]	Preview
	[Fn button for vertical shooting]	AE lock (Reset on release)
	[Fn3 button]	Voice memo
	[AF-ON button]	AF-ON
	[Sub-selector]	Focus point selection
	[Sub-selector center]	AE/AF lock
	[AF-ON button for vertical shooting]	Same as AF-ON button
	[Multi selector for vertical shooting]	Same as multi selector
	[Metering button]	Metering
	[BKT button]	Auto bracketing
	[Movie record button]	None
	[Lens focus function buttons]	AE lock only

	<b>Custom Settings menu option</b>	<b>Default</b>
f4	<b>[Multi selector center button]</b>	
	<b>[Viewfinder photography]</b>	Select center focus point
	<b>[Live view]</b>	Select center focus point
	<b>[Playback mode]</b>	Zoom on/off
	<b>[Zoom on/off]</b>	1 : 1 (100%)
f5	<b>[Shutter spd &amp; aperture lock]</b>	
	<b>[Shutter speed lock]</b>	Off
	<b>[Aperture lock]</b>	Off
f6	<b>[Customize command dials]</b>	
	<b>[Reverse rotation]</b>	Exposure compensation: <input type="checkbox"/> , Shutter speed/aperture: <input type="checkbox"/>
	<b>[Change main/sub]</b>	Exposure setting: Off, Autofocus setting: Off
	<b>[Aperture setting]</b>	Sub-command dial
	<b>[Menus and playback]</b>	Off
	<b>[Sub-dial frame advance]</b>	10 frames

Custom Settings menu option		Default
f7	[Multi selector]	Do nothing
f8	[Release button to use dial]	No
f9	[Reverse indicators]	
f10	[Live view button options]	Enable
f11	[⦿ switch]	LCD backlight (⦿)
f12	[Full-frame playback flicks]	
	[Flick up]	None
	[Flick down]	None
	[Flick advance direction]	Left→Right

	<b>Custom Settings menu option</b>	<b>Default</b>
g1	[ <b>Customize  menu</b> ]	Set Picture Control, White balance, Frame size and rate/Image quality, Microphone sensitivity, Wind noise reduction, Metering, Wired LAN/WT, Electronic VR, Autofocus mode, AF-area mode, Destination, Custom controls
g2	[ <b>Custom controls</b> ]	
	[ <b>Preview button</b> ]	None
	[ <b>Fn1 button</b> ]	None
	[ <b>Fn2 button</b> ]	None
	[ <b>Fn3 button</b> ]	None
	[ <b>Sub-selector center</b> ]	AE/AF lock
	[ <b>Shutter-release button</b> ]	Take photos

	<b>Custom Settings menu option</b>	<b>Default</b>
g3	<b>[Multi selector center button]</b>	Select center focus point
g4	<b>[Highlight display]</b>	
	<b>[Display pattern]</b>	Off
	<b>[Highlight display threshold]</b>	248

## Setup Menu Defaults

Setup menu option	Default
[Format memory card]	—
[Language]	(Varies with country or region of purchase)
[Time zone and date]	
[Time zone]	(Varies with country or region of purchase)
[Date and time]	—
[Date format]	(Varies with country or region of purchase)
[Daylight saving time]	Off
[Monitor brightness]	0
[Monitor color balance]	A-B: 0, G-M: 0
[Virtual horizon]	—
[Information display]	Auto
[Manual]	Dark on light

Setup menu option	Default
<b>[AF fine-tuning options]</b>	
[AF fine-tune on/off]	Off
[Fine-tune and save lens]	—
[Default]	—
[List saved values]	—
[Choose value for current lens]	—
<b>[Non-CPU lens data]</b>	
[Lens number]	1
[Focal length (mm)]	—
[Maximum aperture]	—
<b>[Clean image sensor]</b>	
[Clean at startup/shutdown]	Clean at startup & shutdown
[Lock mirror up for cleaning]	—
[Image Dust Off ref photo]	—
[Pixel mapping]	—
<b>[Image comment]</b>	
[Attach comment]	<input type="checkbox"/>

Setup menu option	Default
<b>[Copyright Information]</b>	
[Attach copyright information]	<input type="checkbox"/>
<b>[IPTC]</b>	
[Edit/save]	—
[Delete]	—
[Auto embed during shooting]	Off
[Load/save]	—
<b>[Voice memo options]</b>	
[Voice memo]	Off
[Voice memo overwrite]	Disable
[Voice memo control]	Press and hold
[Audio output]	Speaker/headphones
<b>[Beep options]</b>	
[Beep on/off]	Off
[Volume]	2
[Pitch]	Low



Setup menu option	Default
<b>[Touch controls]</b>	
[Enable/disable touch controls]	Enable
[Glove mode]	Disabled
<b>[HDMI]</b>	
[Output resolution]	Auto
<b>[Advanced]</b>	
[Output range]	Auto
[Live view on-screen display]	On
[Dual monitor]	On
[External recording control]	Off
<b>[Location data (built-in)]</b>	
[Record location data]	Off
[Standby timer]	Enable
[Set clock from satellite]	No
[Create log]	—
[Log list]	—
[Position]	—

Setup menu option	Default
<b>[Wireless remote (WR) options]</b>	
[LED lamp]	On
[Link mode]	Pairing
<b>[Assign remote (WR) Fn button]</b>	None
<b>[Airplane mode]</b>	Disable
<b>[Connect to smart device]</b>	
<b>[Pairing (Bluetooth)]</b>	
[Bluetooth connection]	Disable
<b>[Select to send (Bluetooth)]</b>	
[Auto select to send]	Off
<b>[Wi-Fi connection]</b>	—
<b>[Send while off]</b>	On
<b>[Location data (smart device)]</b>	—

Setup menu option	Default
<b>[Connect to PC (built-in Wi-Fi)]</b>	
<b>[Wi-Fi connection]</b>	Disable
<b>[Network settings]</b>	—
<b>[Options]</b>	
<b>[Auto send]</b>	Off
<b>[Delete after send]</b>	No
<b>[Send file as]</b>	NEF (RAW) + JPEG
<b>[JPEG+JPEG slot selection]</b>	Slot 1
<b>[Deselect all?]</b>	—
<b>[MAC address]</b>	—

Setup menu option	Default
<b>[Wired LAN/WT]</b>	
<b>[Wired LAN/WT functions]</b>	Disable
<b>[Choose hardware]</b>	Wired LAN
<b>[Network settings]</b>	—
<b>[Options]</b>	
<b>[Auto send]</b>	Off
<b>[Delete after send]</b>	No
<b>[Send file as]</b>	NEF (RAW) + JPEG
<b>[JPEG+JPEG slot selection]</b>	Slot 1
<b>[Overwrite if same name]</b>	No
<b>[Protect if marked to send]</b>	No
<b>[Send marking]</b>	Off
<b>[Send folder]</b>	—
<b>[Deselect all?]</b>	—
<b>[HTTP user settings]</b>	—
<b>[Power saving]</b>	Prioritize network speed
<b>[MAC address]</b>	—
<b>[Conformity marking]</b>	—

<b>Setup menu option</b>	<b>Default</b>
[Battery info]	—
[Slot empty release lock]	Enable release
[Save/load menu settings]	—
[Reset all settings]	—
[Firmware version]	—

## ▶ The Playback Menu: Managing Images

To display the playback menu, select the ▶ (playback menu) tab in the camera menus.

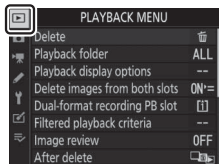





The playback menu contains the following items:

Item		Item	
[Delete]	731	[Image review]	735
[Playback folder]	732	[After delete]	736
[Playback display options]	733	[After burst, show]	737
[Delete images from both slots]	734	[Rotate tall]	738
[Dual-format recording PB slot]	735	[Copy image(s)]	738
[Filtered playback criteria]	735	[Hide image]	746
		[Slide show]	748

# Delete

MENU button ➡  playback menu

Delete multiple images. For more information, see “Deleting Multiple Pictures” (📖 431).

	Option	Description
	[Selected images]	Delete selected pictures.
	[Candidates for deletion]	Delete pictures rated  (candidate for deletion).
	[Images shot on selected dates]	Delete all pictures taken on selected dates.
ALL	[All images]	Delete all pictures in the folder currently selected for [Playback folder] in the playback menu. <ul style="list-style-type: none"><li>• If two memory cards are inserted, you can select the card from which pictures will be deleted.</li></ul>

# Playback Folder

MENU button ➡  playback menu

Choose a folder for playback.



Option	Description
<b>(Folder name)</b>	Pictures in all folders with the selected name will be visible during playback. Folders can be renamed using the [ <b>Storage folder</b> ] > [ <b>Rename</b> ] option in the photo shooting menu.
[All]	Pictures in all folders will be visible during playback.
[Current]	Only pictures in the current folder will be visible during playback.



## Playback Display Options

MENU button ➡  playback menu

Choose whether the focus points used when the photograph was taken are displayed during full-frame playback. You can also choose the types of photo information that can be viewed during full-frame playback.

- The shooting data displayed when [**Shooting data**] is selected can be chosen using [**Detailed shooting data**].
- Highlight options and press  to select () or deselect ()
- To complete the operation, press .

## Delete Images from Both Slots

MENU button ➡ ▶ playback menu

Choose whether deleting a copy of a picture recorded to both memory cards with either [**Backup**] or a dual-format option ([**RAW Slot 1 - JPEG Slot 2**] or [**JPEG Slot 1 - JPEG Slot 2**]) selected for [**Role played by card in Slot 2**] in the photo shooting menu also deletes the remaining copy.

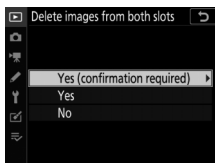

Option	Description
[ <b>Yes (confirmation required)</b> ]	Before deleting one copy, you will be prompted to choose whether to delete the other. To choose the option highlighted by default, press <b>⏪</b> .
[ <b>Yes</b> ]	[ <b>“Same images on [1] and [2]”</b> ] is always selected; selecting [ <b>Yes</b> ] in the confirmation dialog deletes both copies.
[ <b>No</b> ]	The confirmation dialog displayed is the same as that for pictures for which no second copy exists. Deleting the current picture does not delete the copy.

## Dual-Format Recording PB Slot

MENU button ➡  playback menu

Choose the slot from which dual-format pictures recorded with [RAW Slot 1 - JPEG Slot 2] or [JPEG Slot 1 - JPEG Slot 2] selected for [Role played by card in Slot 2] in the photo shooting menu are played back.

## Filtered Playback Criteria

MENU button ➡  playback menu

Choose the criteria used to choose the pictures displayed during filtered playback ( 427).

## Image Review



MENU button ➡  playback menu

Choose whether pictures are automatically displayed in the monitor immediately after shooting. If [Off] is selected, pictures can only be displayed by pressing the  button.

## After Delete

MENU button ➡  playback menu

Choose the picture displayed after an image is deleted.

Option	Description
 <b>[Show next]</b>	<ul style="list-style-type: none"><li>• The following picture is displayed.</li><li>• If the deleted image was the last picture, the preceding picture will be displayed.</li></ul>
 <b>[Show previous]</b>	<ul style="list-style-type: none"><li>• The preceding picture is displayed.</li><li>• If the deleted image was the first picture, the next picture will be displayed.</li></ul>
 <b>[Continue as before]</b>	<ul style="list-style-type: none"><li>• If you were scrolling through pictures in the order recorded, the following picture will be displayed as described for <b>[Show next]</b>.</li><li>• If you were scrolling through pictures in reverse order, the next picture will be displayed as described for <b>[Show previous]</b>.</li></ul>

## After Burst, Show

MENU button ➡  playback menu

Choose whether the photo displayed immediately after a burst of shots is taken in continuous mode is the first or last shot in the burst.

- This option takes effect only when [**Off**] is selected for [**Image review**].

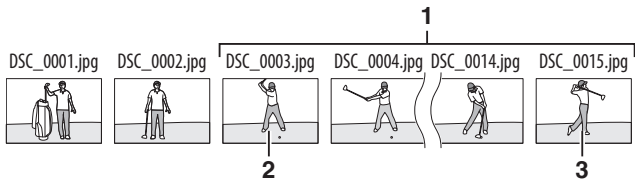

- 1 Most recent shots (burst)
- 2 Displayed if [**First image in burst**] is selected
- 3 Displayed if [**Last image in burst**] is selected

## Rotate Tall

MENU button ➡  playback menu

If **[On]** is selected, “tall” (portrait-orientation) pictures will be automatically rotated for display during playback.

### ✔ Rotate Tall

Images are not rotated automatically during image review even when **[On]** is selected for **[Rotate tall]**.

## Copy Image(s)

MENU button ➡  playback menu

Copy pictures from one memory card to another when two memory cards are inserted.

Option	Description
<b>[Select source]</b>	Choose the card from which pictures will be copied.
<b>[Select image(s)]</b>	Select pictures to be copied.
<b>[Select destination folder]</b>	Select the destination folder on the remaining card (the card not chosen for <b>[Select source]</b> ).
<b>[Copy image(s)?]</b>	Copy the pictures.

# Copying Pictures

## 1 Choose [Select source].

Highlight [**Select source**] and press  to display [**Select source**] options.

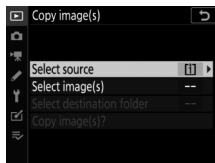

## 2 Select the card containing the pictures to be copied.

Highlight the slot for the card containing the pictures to be copied and press  to select the highlighted slot and return to the [**Copy image(s)**] menu.

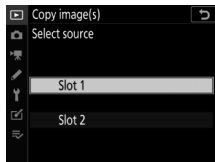

### 3 Choose [Select image(s)].

Highlight [**Select image(s)**] and press **▶** to view the [**Select image(s)**] display.

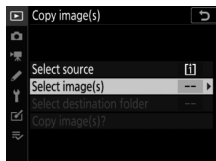

### 4 Select the source folder.

- Highlight the folder containing the images to be copied and press **▶** to display the [**Images selected by default**] menu.
- To copy all pictures from the card in the selected slot, highlight [**All images in slot**], press **OK**, and proceed to Step 10.

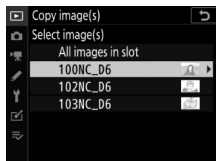



## 5 Make the initial selection.

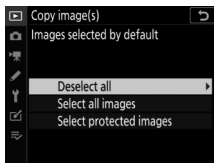

Choose the pictures that will be selected by default.



Option	Description
[Deselect all]	None of the pictures in the chosen folder will be selected by default. <ul style="list-style-type: none"><li>• Choose this option when you want to select pictures individually.</li></ul>
[Select all images]	All of the pictures in the chosen folder will be selected by default. <ul style="list-style-type: none"><li>• Choose this option if you want to copy all or most of the pictures in the folder.</li></ul>
[Select protected images]	Only the protected images in the folder will be selected by default.

---

## 6 Select additional images.

- Highlight pictures and press the center of the multi selector to select; selected pictures are marked with a check (✓). To deselect the current picture, press the center of the multi selector again; the check (✓) will no longer be displayed.
- To view the highlighted picture full screen, press and hold the  button.
- After confirming that you have selected (✓) all the pictures you want to copy, press  to return to the [**Copy image(s)**] menu.



---

## 7 Choose [Select destination folder].

Highlight [**Select destination folder**] and press  to display [**Select destination folder**] options.

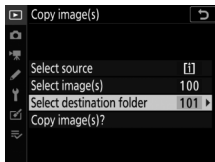

## 8 Choose a destination folder.

Choose one of the following options and press .

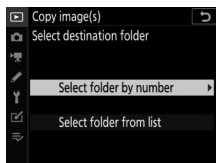

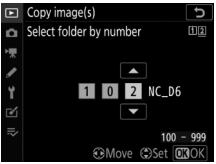
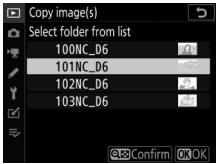
Option	Description
<b>[Select folder by number]</b>	Enter the number of the destination folder (☐☐ 756). If the folder with the selected number does not already exist, a new folder will be created. 
<b>[Select folder from list]</b>	Choose the destination folder from a list of existing folders. 

---

## 9 Select the chosen folder.

After entering a folder number or highlighting the folder name, press **OK** to select the folder and return to the **[Copy image(s)]** menu.

---

## 10 Choose **[Copy image(s)?]**.

Highlight **[Copy image(s)?]** and press **OK** to display a confirmation dialog.

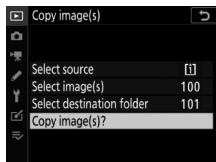

---

## 11 Choose **[Yes]**.

- The camera will display the message "**[Copy?]**" together with the number of pictures that will be copied.
- Highlight **[Yes]** and press **OK** to copy the selected pictures.
- Press **OK** again to exit when copying is complete.



---

## ✓ Copying Pictures

- Pictures will not be copied if there is insufficient space on the destination card.
- If the destination folder contains a file with the same name as one of the pictures to be copied, a confirmation dialog will be displayed. Select [**Replace existing image**] or [**Replace all**] to replace the existing file or files. Protected files in the destination folder will not be replaced. To continue without replacing existing files, select [**Skip**]. Select [**Cancel**] to exit without copying any further pictures.
- Ratings and protected status are copied with the pictures.
- Hidden pictures cannot be copied.
- To prevent loss of power while copying is in progress, be sure the battery is fully charged before copying movies.

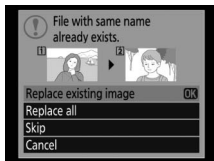

# Hide Image

MENU button ➡ ▶ playback menu



Hidden pictures are visible only in the “hide image” menu.

## 1 Choose [Select/set].

Highlight [**Select/set**] and press  to display a picture-selection dialog.



## 2 Select pictures.

- Highlight pictures using the multi selector and press the center of the multi selector to select. Selected pictures are marked with  icons. To deselect the current picture, removing the  icon, press the center of the multi selector again.
- Continue until you have selected all the desired pictures.
- To view the highlighted picture full screen, press and hold the  button.



### 3 Save changes.

Press **OK** to complete the operation.

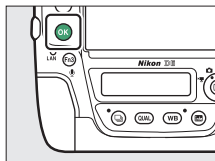

---

#### ✓ Hidden Pictures

- Hidden pictures will be deleted when the memory card is formatted.
- Revealing a protected image will also remove protection from the image.

---

#### ✎ Revealing All Hidden Pictures

To reveal all pictures hidden using **[Hide image]**, choose **[Deselect all]** in the **[Hide image]** display.

---

# Slide Show

MENU button ➡  playback menu

View a slide show; pictures are displayed in the order recorded. The pictures in the folder currently selected for [**Playback folder**] (📖 732) will be displayed one-by-one in the order recorded. Pictures hidden using [**Hide image**] (📖 746) are not displayed.

Option	Description
[ <b>Start</b> ]	Start the slide show.
[ <b>Image type</b> ]	<ul style="list-style-type: none"><li>• Choose the type of picture displayed.</li><li>• Select [<b>By rating</b>] to view only pictures with selected ratings. Highlight ratings and press  to select (<input checked="" type="checkbox"/>) or deselect (<input type="checkbox"/>)</li></ul>
[ <b>Frame interval</b> ]	Choose how long each picture will be displayed.

## Viewing Slide Shows

To start the slide show, highlight [**Start**] and press .

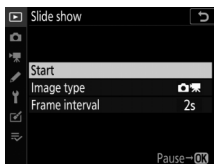



The following operations can be performed while the show is in progress:

To	Description
<b>Skip back/skip ahead</b>	Press ◀ to return to the previous frame, ▶ to skip to the next frame.
<b>View additional photo info</b>	Press ▲ or ▼ to choose the photo info displayed. To hide photo info, select <b>[None (image only)]</b> .
<b>Pause</b>	Press Ⓞ to pause the slide show. To restart, highlight <b>[Restart]</b> and press Ⓞ.
<b>Adjust volume</b>	Press 🔊 to increase volume, 🔊 (⚡) to decrease.
<b>Exit to the playback menu</b>	Press MENU to end the slide show and return to the playback menu.
<b>Exit to playback mode</b>	Press ▶ to end the slide show and exit to full-frame or thumbnail playback.
<b>Resume shooting</b>	Press the shutter-release button halfway to return to shooting mode.

A dialog is displayed when the show ends. To restart, highlight **[Restart]** and press Ⓞ. To end the show, highlight **[Exit]** and press Ⓞ.



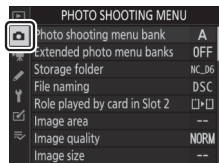

## The Photo Shooting Menu: Shooting Options

To view the photo shooting menu, select the  tab in the camera menus.



The photo shooting menu contains the following items:

Item		Item	
[Photo shooting menu bank]	752	[ISO sensitivity settings]	764
[Extended photo menu banks]	754	[White balance]	764
[Storage folder]	755	[Set Picture Control]	764
[File naming]	760	[Manage Picture Control]	765
[Role played by card in Slot 2]	761	[Color space]	765
[Image area]	761	[Active D-Lighting]	766
[Image quality]	761	[Long exposure NR]	767
[Image size]	762	[High ISO NR]	768
[NEF (RAW) recording]	762	[Vignette control]	769
		[Diffraction compensation]	770
		[Auto distortion control]	771

Item	
[Flicker reduction]	772
[Flash control]	774
[Auto bracketing]	778
[Multiple exposure]	779
[HDR (high dynamic range)]	779

Item	
[Interval timer shooting]	780
[Time-lapse movie]	780
[Focus shift shooting]	780
[Silent live view photography]	781

# Photo Shooting Menu Bank

MENU button → photo shooting menu

Photo shooting menu options are stored in one of four banks (banks “A” through “D”). Changes to settings in one bank have no effect on the others. Note, however, that changes to **[Extended photo menu banks]**, **[White balance]** presets, **[Multiple exposure]**, **[Interval timer shooting]**, **[Time-lapse movie]**, and **[Focus shift shooting]** apply to all banks.

To store a particular combination of frequently-used settings, select one of the four banks using **[Photo shooting menu bank]** and adjust settings as desired.

## ✔ Photo Shooting Menu Bank

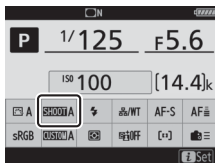
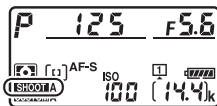

The information and top control panel displays show the current photo shooting menu bank as **SHOOT** followed by bank name (“A”, “B”, “C”, or “D”).



## Renaming Photo Shooting Menu Banks

A descriptive caption can be added to the bank name (“A”, “B”, “C”, or “D”) by highlighting the bank and pressing . Captions can be up to 20 characters long.

## Restoring Default Settings

You can restore default settings for a selected photo shooting menu bank. To do so, highlight the bank and press  (FORMAT); a confirmation dialog will be displayed. Highlight [Yes] and press  to restore default settings for the selected bank.

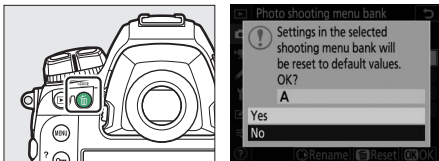

- Photo shooting menu reset is not available while a multiple exposure is in progress.

## Extended Photo Menu Banks

MENU button →  photo shooting menu

Select [**On**] to include exposure and flash modes, shutter speed (modes **S** and **M** only), and aperture (modes **A** and **M** only) in the information recorded in each of the four photo shooting menu banks.

- Changes to exposure mode, shutter speed, aperture, and flash mode will be stored in the bank currently selected for [**Photo shooting menu bank**]. The settings stored in the bank will be recalled the next time the bank is selected.
- Selecting [**Off**] restores the exposure and flash modes, shutter speed, and aperture in effect before [**On**] was selected.

# Storage Folder

MENU button ➡ photo shooting menu

Choose the folder in which subsequent pictures will be stored.



- 1 Folder
- 2 Folder number
- 3 Folder name

## Renaming Folders

The default folder name, which appears after the folder number, is “NC\_D6”. To change the name assigned to new folders, select **[Rename]**.

- Existing folders cannot be renamed.
- If desired, the default name can be restored for subsequent folders by pressing and holding the  (FORMAT) button while the keyboard is displayed.

## Select Folder by Number





The folder in which subsequent pictures will be stored can be selected by number. If a folder with the specified number does not already exist, a new folder will be created.

### 1 Choose [Select folder by number].

- Highlight [Select folder by number] and press  to display the [Select folder by number] dialog.
- The card on which the new folder will be created is underlined in the card slot display area at the top right corner of the [Select folder by number] dialog. The card used for new folders depends on the option currently selected for [Role played by card in Slot 2] in the photo shooting menu.









### 2 Choose a folder number.

- Press  or  to highlight digits.
- To change the highlighted digit, press  or .







---

### 3 Save changes and exit.

- If a folder with the selected number already exists, a , , or  icon will be displayed to the left of the folder number. Press  to complete the operation and return to the main menu; if you chose a folder marked  or , it will be selected as the folder for new pictures.
- If you chose a folder number that does not already exist, a new folder will be created with that number when you press .
- In either case, subsequent pictures will be stored in the chosen folder.
- To exit without changing the storage folder, press the **MENU** button.

---

#### Folder Icons

Folders in the **[Select folder by number]** dialog are shown by  if empty, by  if full (containing either 5000 pictures or a picture numbered 9999), or by  if partially full. A  icon indicates that no further pictures can be stored in the folder.

---

## Select Folder from List

To choose from a list of existing folders:

---



### 1 Choose [Select folder from list].

Highlight [Select folder from list] and press  to display the [Select folder from list] dialog.



---

### 2 Highlight a folder.

Press  or  to highlight a folder.

---

### 3 Select the highlighted folder.

- Press  to select the highlighted folder and return to the main menu.
- Subsequent photographs will be stored in the selected folder.

---

## ✔ Folder and File Numbers

- Once the folder number has reached 999, the camera will stop creating new folders automatically and disable the shutter release if:
  - the number of files in the folder reaches 5000 (or during movie recording, if camera calculates that the addition of the number of files needed to create a movie of maximum length would bring the total over 5000), or
  - the file number reaches 9999 (or during movie recording, when camera calculates that the number of files needed to create a movie of maximum length would result in a file numbered higher than 9999).
- If there is space on the memory card, you will nevertheless be able to continue shooting by:
  - creating a folder with a number less than 999 and selecting it as the storage folder, or
  - changing the options selected for [**Frame size/frame rate**] and [**Movie quality**] before recording movies.

## ✔ Startup Time

Additional time may be required for camera startup if the memory card contains a very large number of files or folders.

---

# File Naming

MENU button →  photo shooting menu

Pictures are saved using file names consisting of “DSC\_” followed by a four-digit number and a three-letter extension. **[File naming]** is used to select three letters to replace the “DSC” portion of the file name. For information on text entry, see “Text Entry” (📖 86).

---

## ✔ File Names

- File names take the form “DSC\_nnnn.xxx”. “nnnn” is a number from 0001 to 9999. “xxx” is one of the following extensions, assigned according to the options selected for image quality and file type.
    - NEF: NEF (RAW) photos
    - JPG: JPEG (fine, normal, or basic) photos
    - MOV: MOV movies
    - MP4: MP4 movies
    - NDF: Dust off reference data
  - Images created with **[Adobe RGB]** selected for **[Color space]** have file names of the form “\_DSCnnnn.xxx”.
  - Both files in each pair of dual-format photographs have the same name. In the case of dual-format photographs recorded at image-quality settings of NEF (RAW)+JPEG, the two files will however have different extensions (“.NEF” versus “.JPG”).
-

## Role Played by Card in Slot 2

MENU button ➔  photo shooting menu

Choose the role played by the card in Slot 2 when two memory cards are inserted in the camera. For more information, see “Using Two Memory Cards” (📖 308).

## Image Area

MENU button ➔  photo shooting menu

Adjust image area settings. For more information, see “Adjusting Image Area Settings” (📖 136).

## Image Quality

MENU button ➔  photo shooting menu

Choose a file format for photographs. For more information, see “Adjusting Image Quality” (📖 142).

## Image Size

MENU button →  photo shooting menu



Choose the size, in pixels, of JPEG or NEF (RAW) pictures recorded with the camera. For more information, see “Choosing an Image Size” (📖 145).

## NEF (RAW) Recording

MENU button →  photo shooting menu

Choose a compression type and bit depth for NEF (RAW) photographs.

## NEF (RAW) Compression

Option		Description
ON 	[Lossless compressed]	NEF pictures are compressed using a reversible algorithm. The resulting files are about 60% to 80% the size of pictures recorded using [Uncompressed]. Image quality is the same as pictures recorded using [Uncompressed].
ON 	[Compressed]	NEF images are compressed using a non-reversible algorithm. The resulting files are about 45% to 65% the size of pictures recorded using [Uncompressed]. Image quality is nearly the same as pictures recorded using [Uncompressed].
	[Uncompressed]	NEF pictures are not compressed; the resulting files are larger than those for pictures recorded using [Lossless compressed] or [Compressed].

## NEF (RAW) Bit Depth

Option		Description
12-bit	[12-bit]	NEF (RAW) images are recorded at a bit depth of 12 bits.
14-bit	[14-bit]	NEF (RAW) images are recorded at a bit depth of 14 bits. Files recorded at a bit depth of 14 bits contain more color data than pictures recorded using [12-bit]. Files recorded at a bit depth of 14 bits are also larger than pictures recorded using [12-bit].

## ISO Sensitivity Settings

MENU button →  photo shooting menu

Adjust ISO sensitivity settings for photographs. For more information, see “Adjusting the Camera’s Sensitivity to Light (ISO Sensitivity)” (📖 213).

## White Balance

MENU button →  photo shooting menu

Adjust white balance to match the color of the light source. For more information, see “Achieving Natural Colors with Different Light Sources (White Balance)” (📖 221).

## Set Picture Control

MENU button →  photo shooting menu

Adjust image processing (Picture Control) settings according to your subject or creative intent. For more information, see “Image Processing (Picture Controls)” (📖 271).



## Manage Picture Control

MENU button ➔  photo shooting menu

Save modified Picture Controls as custom Picture Controls. For more information, see “Custom Picture Controls” (📖 276).

## Color Space

MENU button ➔  photo shooting menu

The color space determines the gamut of colors available for color reproduction. [sRGB] is recommended for general-purpose printing and display. With a broader gamut of colors than [sRGB], [Adobe RGB] is a better choice for professional publication and commercial printing.

---

### ✔ Color Space

Capture NX-D and ViewNX-i automatically select the correct color space when opening photographs created with this camera. Results cannot be guaranteed with third-party software.

### ✔ Adobe RGB

For accurate color reproduction, Adobe RGB images require applications, displays, and printers that support color management.

---

## Active D-Lighting

MENU button →  photo shooting menu

Preserve details in highlights and shadows, creating pictures with natural contrast. For more information, see “Active D-Lighting” ( 281).

# Long Exposure NR

MENU button ➔  photo shooting menu

Reduce “noise” (bright spots or fog) in photographs taken at slow shutter speeds.

Option	Description
[On]	Reduce noise in photographs taken at shutter speeds slower than 1 s.
[Off]	Long-exposure noise reduction disabled.

- Long-exposure noise reduction is performed after the photo is taken. During processing, “**Job nr**” will flash in the viewfinder and top control panel. Pictures cannot be taken until the display stops flashing. The time required to process photos after shooting roughly doubles.



## ✓ Long-Exposure Noise Reduction

If the camera is turned off before processing is complete, the picture will be saved but noise reduction will not be performed.

## High ISO NR

MENU button →  photo shooting menu

Photographs taken at high ISO sensitivities can be processed to reduce “noise” (randomly-spaced bright pixels).

Option	Description
[High]	Reduce noise in photographs taken at all ISO sensitivities.
[Normal]	The higher the sensitivity, the greater the effect. Choose the amount of noise reduction performed from [High], [Normal], and [Low].
[Low]	
[Off]	Noise reduction is performed only as required. The amount of noise reduction performed is always lower than when [Low] is selected.

# Vignette Control

MENU button ➔  photo shooting menu

Vignette control reduces “vignetting”—a drop in brightness at the edges of a photograph—by an amount that varies from lens to lens. Its effects are most noticeable at maximum aperture. Vignette control applies only to photographs taken with type G, E, and D lenses (PC lenses excluded).

Option	Description
<input type="checkbox"/> H [High]	Choose the amount of vignette control performed from (in order from high to low) [High], [Normal], and [Low].
<input type="checkbox"/> N [Normal]	
<input type="checkbox"/> L [Low]	
[Off]	Vignette control disabled.

## Vignette Control

- Vignette control does not apply to:
  - pictures taken using the [Multiple exposure] item in the photo shooting menu, or
  - movies.
- Depending on the scene, shooting conditions, and type of lens, JPEG images may exhibit “noise” (fog) or over-processing at the edge of the frame that introduces variations in peripheral brightness. In addition, custom Picture Controls and preset Picture Controls that have been modified from default settings may not produce the desired effect. Take test shots and view the results in the monitor.

## Diffraction Compensation

MENU button →  photo shooting menu

Select [**On**] to reduce diffraction at small apertures (high f/-numbers).

- To apply diffraction compensation to pictures taken with non-CPU lenses, enter the lens data using the [**Non-CPU lens data**] item in the setup menu.

# Auto Distortion Control

MENU button ➔  photo shooting menu

Select **[On]** to reduce barrel distortion when shooting with wide-angle lenses and to reduce pin-cushion distortion when shooting with long lenses.

- **[Auto distortion control]** is available only with type G, E, and D lenses. Some lenses of these types, including PC and fisheye lenses, are, however, not supported. Results are not guaranteed with lenses that are not supported.

---

## Auto Distortion Control

- When **[On]** is selected, the time needed to process photographs before recording begins may increase.
  - The greater the amount of distortion control, the greater the area cropped from the edges of the frame.
  - Before using auto distortion control with DX lenses, choose **[On]** for **[Image area] > [Auto DX crop]** or select **[DX (24×16)]** for **[Choose image area]**. Selecting other options may result in heavily cropped photographs or in photographs with severe peripheral distortion.
  - Auto distortion control does not apply to movies.
-

# Flicker Reduction

MENU button → 📷 photo shooting menu

Reduce the effects of flicker from such light sources as fluorescent or mercury-vapor lamps during viewfinder photography. Flicker can cause uneven exposure or (in photographs taken in continuous release modes) inconsistent exposure or coloration.

Option	Description
<b>[Flicker reduction setting]</b>	<p>When <b>[Enable]</b> is selected, the camera will time photographs to reduce the effects of flicker.</p> <ul style="list-style-type: none"><li>• Note that the frame rate for burst shooting may drop or become erratic when <b>[Enable]</b> is selected.</li></ul>
<b>[Flicker reduction indicator]</b>	<p>Choose whether a <b>FLICKER</b> icon is displayed in the viewfinder when flicker is detected.</p> <ul style="list-style-type: none"><li>• Selecting <b>[Enable]</b> for <b>[Flicker reduction setting]</b> and <b>[On]</b> for <b>[Flicker reduction indicator]</b> during viewfinder photography causes the <b>FLICKER</b> icon to be displayed if flicker is detected when the shutter-release button is pressed halfway. If <b>[Disable]</b> is selected for <b>[Flicker reduction setting]</b>, the <b>FLICKER</b> icon will flash.</li></ul>

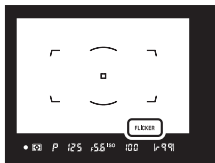



---

### ✔ **Flicker Reduction: Restrictions**

The [**Flicker reduction**] item in the photo shooting menu does not take effect under some conditions, including:

- during live view photography or when
- **MUP** is selected for release mode,
- [**On**] is selected for [**Silent photography**] in the respective sub-menu during interval-timer photography, time-lapse movie recording, or focus shift,
- HDR is enabled,
- exposure delay mode is on, or
- shutter speed is set to **b** **u** **l** **b** ("Bulb") or - - ("Time").

### ✔ **Flicker Reduction**

- Take a test shot and view the results before taking additional photographs.
  - Depending on the light source, flicker reduction may slightly delay shutter response. During burst shooting, the frame rate may slow or become erratic.
  - Flicker reduction can detect flicker at 100 and 120 Hz (associated respectively with AC power supplies of 50 and 60 Hz). The desired results may not be achieved if the frequency of the power supply changes during burst photography.
  - Flicker may not be detected or the desired results may not be achieved depending on the light source and shooting conditions, for example with scenes that are brightly lit or feature dark backgrounds.
  - The desired results may also not be achieved with decorative lighting displays and other non-standard lighting.
-

# Flash Control

MENU button →  photo shooting menu

Choose a flash control mode and flash level and adjust other settings for wireless remote flash units or optional flash units mounted on the camera accessory shoe.

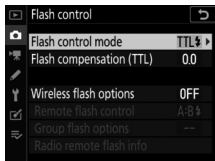

- For information on adjusting settings for optional flash units mounted on the camera accessory shoe, see “On-Camera Flash Photography” (📖 640).
- For information on adjusting settings for wireless remote flash units, see “Remote Flash Photography” (📖 663).

## **Flash Control Mode**



Choose a flash control mode and adjust other settings for SB-5000, SB-500, SB-400, or SB-300 flash units mounted on the camera accessory shoe.

- The contents of the [**Flash control mode**] display vary with the options selected.
- Settings for units other than the SB-5000, SB-500, SB-400, and SB-300 can only be adjusted via the controls on the flash unit.
- Settings for the SB-5000 can also be adjusted using the controls on the flash unit.

<b>Option</b>	<b>Description</b>
[ <b>TTL</b> ]	Flash output is adjusted automatically in response to lighting conditions.
[ <b>Auto external flash</b> ]	Light from the flash is reflected from the subject to an auto external flash sensor and flash output adjusted automatically.
[ <b>Distance-priority manual</b> ]	Choose the distance to the subject; flash output will be adjusted automatically.
[ <b>Manual</b> ]	Choose the flash level manually.
[ <b>Repeating flash</b> ]	The flash fires repeatedly while the shutter is open, producing a multiple-exposure effect.

## Wireless Flash Options

Adjust settings for simultaneous wireless control of multiple remote flash units. This item is available only when an SB-5000 or SB-500 flash unit or a WR-R10 wireless remote controller is mounted on the camera.

	Option	Description
	[Optical AWL]	The remote flash units are controlled using low-intensity flashes emitted by the master flash (☐ 680).
	[Optical/radio AWL]	Choose this option when using both optically- and radio-controlled flash units (☐ 694).
	[Radio AWL]	The remote flash units are controlled by radio signals from a WR-R10 attached to the camera (☐ 665).
[Off]		Remote flash photography disabled.

## Remote Flash Control

Choose the remote flash control mode. Flash options can be adjusted in the flash control display; the options available vary with the option selected for [Remote flash control].

Option		Description
GRP ↕	[Group flash]	Choose a separate flash control mode for each group of remote flash units (☞ 670, 682).
A:B ↕	[Quick wireless control]	Choose the balance between groups A and B and adjust output for group C manually (☞ 673, 686).
RPT ↕	[Remote repeating]	The flash units fire repeatedly while the shutter is open, producing a multiple-exposure effect (☞ 676, 690).

## Radio Remote Flash Info

View the flash units currently controlled via radio AWL.

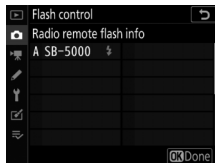

# Auto Bracketing

MENU button →  photo shooting menu

Bracketing automatically varies exposure, flash level, Active D-Lighting (ADL), or white balance slightly with each shot, “bracketing” the current value. Choose in situations in which getting the right settings is difficult and there is not time to check results and adjust settings with each shot, or to experiment with different settings for the same subject. For more information, see “Varying Exposure or White Balance over a Series of Photographs (Bracketing)” (📖 249).

Option	Description
[Auto bracketing set]	<p>Choose the setting or settings bracketed when auto bracketing is in effect.</p> <ul style="list-style-type: none"><li>• <b>[AE &amp; flash bracketing]</b>: Perform both exposure and flash-level bracketing.</li><li>• <b>[AE bracketing]</b>: Bracket only exposure.</li><li>• <b>[Flash bracketing]</b>: Perform only flash-level bracketing.</li><li>• <b>[WB bracketing]</b>: Perform white-balance bracketing.</li><li>• <b>[ADL bracketing]</b>: Perform bracketing using Active D-Lighting.</li></ul>
[Number of shots]	<p>Choose the number of shots in the bracketing sequence.</p>

Option	Description
[Increment]	Choose the amount the selected settings vary with each shot when an option other than [ADL bracketing] is selected for [Auto bracketing set].
[Amount]	Choose how Active D-Lighting varies with each shot when [ADL bracketing] is selected for [Auto bracketing set].

## Multiple Exposure

MENU button →  photo shooting menu

Record two to ten NEF (RAW) exposures as a single photograph. For more information, see “Combining Multiple Exposures in a Single Photo (Multiple Exposure)” (📖 318).

## HDR (High Dynamic Range)

MENU button →  photo shooting menu

Used with high contrast subjects, high dynamic range (HDR) preserves details in highlights and shadows by combining two shots taken at different exposures. For more information, see “High Dynamic Range (HDR)” (📖 283).

## Interval Timer Shooting

MENU button →  photo shooting menu

Take photographs at the selected interval until the specified number of shots has been recorded. For more information, see “Taking Photos at a Set Interval (Interval Timer Shooting)” (📖 331).

## Time-Lapse Movie

MENU button →  photo shooting menu

The camera automatically takes photos at selected intervals to create a time-lapse movie. For more information, see “Creating a Movie from Photos (Time-Lapse Movie)” (📖 348).

## Focus Shift Shooting

MENU button →  photo shooting menu

Focus shift automatically varies focus over a series of shots. Use it to take photos that will later be combined using focus stacking to create a single image with increased depth of field. For more information, see “Varying Focus over a Series of Photos (Focus Shift Shooting)” (📖 360).



## Silent Live View Photography

MENU button ➔  photo shooting menu

Enable the electronic shutter during live view photography to mute shutter sounds and eliminate the vibrations produced by the mechanical shutter. For more information, see “The Electronic Shutter (Silent Live View Photography)” (📖 374).

## 🎬 The Movie Shooting Menu: Movie Shooting Options

To view the movie shooting menu, select the 🎬 tab in the camera menus.

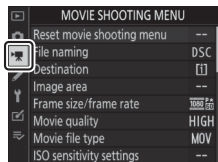

The movie shooting menu contains the following items:

Item	📖	Item	📖
[Reset movie shooting menu]	783	[Active D-Lighting]	788
[File naming]	783	[High ISO NR]	789
[Destination]	783	[Diffraction compensation]	789
[Image area]	784	[Flicker reduction]	790
[Frame size/frame rate]	784	[Electronic VR]	791
[Movie quality]	785	[Microphone sensitivity]	792
[Movie file type]	785	[Attenuator]	793
[ISO sensitivity settings]	786	[Frequency response]	793
[White balance]	787	[Wind noise reduction]	794
[Set Picture Control]	788	[Headphone volume]	794
[Manage Picture Control]	788	[Timecode]	795

## Reset Movie Shooting Menu

MENU button →  movie shooting menu

Restore movie shooting menu options to their default values.

## File Naming

MENU button →  movie shooting menu

Choose the three-letter prefix used in naming the image files in which movies are stored; the default prefix is “DSC” (📖 760).

## Destination

MENU button →  movie shooting menu

Choose the slot to which movies are recorded when two memory cards are inserted.

- The menu shows the time available on each card.
- Recording ends automatically when no time remains on the current card.

## Image Area

MENU button ➡  movie shooting menu

Choose the image area for movies.

### Auto DX Crop

Choose whether the camera automatically uses the [DX] image area for movies recorded with a DX lens.

## Frame Size/Frame Rate

MENU button ➡  movie shooting menu

Choose the movie frame size (in pixels) and frame rate. For more information, see “Frame Size/Frame Rate and Movie Quality” (📖 294).

## Movie Quality

MENU button ➡  movie shooting menu

Choose from [**High quality**] and [**Normal**]. For more information, see “Frame Size/Frame Rate and Movie Quality” (📖 294).

## Movie File Type

MENU button ➡  movie shooting menu

Record movies in MOV or MP4 format.

- The audio recording format varies with movie file format.  
Linear PCM is used for MOV files and AAC for MP4 files.

# ISO Sensitivity Settings

MENU button ➡  movie shooting menu

Adjust the following ISO sensitivity settings for use during filming.

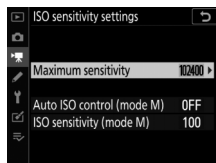

Option	Description
[Maximum sensitivity]	<ul style="list-style-type: none"><li>• Choose the upper limit for auto ISO sensitivity control from values between ISO 200 and Hi 5.</li><li>• The selected value serves as the upper limit for ISO sensitivity in modes <b>P</b>, <b>S</b>, and <b>A</b> and when [<b>On</b>] is selected for [<b>Auto ISO control (mode M)</b>] in mode <b>M</b>.</li></ul>
[Auto ISO control (mode M)]	<ul style="list-style-type: none"><li>• [<b>On</b>]: Enable auto ISO sensitivity control in mode <b>M</b>.</li><li>• [<b>Off</b>]: Disable auto ISO sensitivity control in mode <b>M</b> and instead use the value selected for [<b>ISO sensitivity (mode M)</b>].</li><li>• Regardless of the option selected, auto ISO sensitivity control is used in modes other than <b>M</b>.</li></ul>
[ISO sensitivity (mode M)]	Choose the ISO sensitivity for mode <b>M</b> from values between ISO 100 and Hi 5.

## ✓ Auto ISO Sensitivity Control

- “Noise” (randomly-spaced bright pixels, fog, or lines) may increase at high ISO sensitivities.
- At high ISO sensitivities, the camera may have difficulty focusing.
- The foregoing can be prevented by choosing a lower value for [**ISO sensitivity settings**] > [**Maximum sensitivity**].

## White Balance

MENU button ➔ 🎬 movie shooting menu

Choose the white balance for movies.

Select [**Same as photo settings**] to use the option currently selected for photos (📖 764).

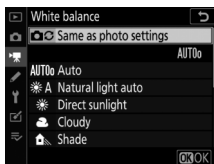

## Set Picture Control

MENU button ➡  movie shooting menu

Choose a Picture Control for movies.

Select [**Same as photo settings**] to use the option currently selected for photos ( 764).

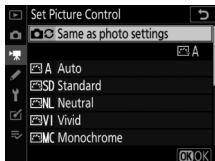



## Manage Picture Control

MENU button ➡  movie shooting menu

Save modified Picture Controls as custom Picture Controls ( 765).

## Active D-Lighting

MENU button ➡  movie shooting menu

Preserve details in highlights and shadows, creating movies with natural contrast ( 281).

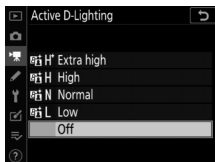





## High ISO NR

MENU button →  movie shooting menu

Reduce “noise” (randomly-spaced bright pixels) in movies recorded at high ISO sensitivities ( 768).

## Diffraction Compensation

MENU button →  movie shooting menu

Reduce diffraction in movies ( 770).

# Flicker Reduction

MENU button ➡  movie shooting menu

Reduce flicker and banding when shooting under fluorescent or mercury-vapor lighting during live view or movie recording.

**[Auto]**, in which the camera chooses the frequency automatically, is recommended in most situations. If **[Auto]** fails to produce the desired results, select **[50 Hz]** or **[60 Hz]** according to the frequency of the local power supply. Choose **[50 Hz]** for areas with a 50 Hz power supply, **[60 Hz]** for areas with a 60 Hz power supply.

---

## ✓ Flicker Reduction

- If **[Auto]** fails to produce the desired results and you are unsure as to the frequency of the local power supply, test both the 50 and 60 Hz options and choose the one that produces the best results.
- Flicker reduction may not produce the desired results if the subject is very bright. If this is the case, try choosing a smaller aperture (higher f-number).
- Flicker reduction may fail to produce the desired results in modes other than **M**. If this is the case, select mode **M** and choose a shutter speed adapted to the frequency of the local power supply:
  - 50 Hz:  $1/100$  s,  $1/50$  s,  $1/25$  s
  - 60 Hz:  $1/125$  s,  $1/60$  s,  $1/30$  s

# Electronic VR

MENU button →  movie shooting menu

Choose whether to enable electronic vibration reduction during filming.

Option	Description
<b>[On]</b>	<ul style="list-style-type: none"><li>• Enable electronic vibration reduction during filming.</li><li>• Electronic vibration reduction is not available at frame sizes of 3840 × 2160 or 1920 × 1080 crop.</li><li>• Note that when <b>[On]</b> is selected for electronic vibration reduction, the angle of view will be reduced, slightly increasing the apparent focal length.</li><li>• The maximum sensitivity for movie recording is fixed at ISO 102400.</li></ul>
<b>[Off]</b>	Electronic vibration reduction is disabled.

# Microphone Sensitivity

MENU button →  movie shooting menu

Turn external microphones or the built-in movie microphone on or off or adjust microphone sensitivity.

Option	Description
[Auto]	Microphone sensitivity is adjusted automatically.
[Manual]	Adjust microphone sensitivity manually. Choose from values of from [1] to [20]. The higher the value, the higher the sensitivity; the lower the value, the lower the sensitivity.
[Microphone off]	Turn sound recording off.

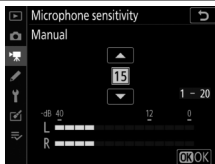

## ✓ Silent Movies

Movies recorded with [Microphone off] selected for [Microphone sensitivity] are indicated by a  icon.



## Attenuator



MENU button →  movie shooting menu

Select [**Enable**] to reduce microphone gain and prevent audio distortion when recording movies in loud environments.

## Frequency Response

MENU button →  movie shooting menu

Choose the frequency response of external microphones and the built-in movie microphone.

Option		Description
 WIDE	[Wide range]	Record a wide range of frequencies. Choose for everything from music to the bustling hum of a city street.
 VOICE	[Vocal range]	Choose for human voices.

## Wind Noise Reduction



MENU button ➡  movie shooting menu

Select [**On**] to enable the low-cut filter, reducing noise produced by wind blowing over the built-in microphone when filming movies. Note that other sounds may also be affected.

Selecting [**On**] for [**Wind noise reduction**] has no effect on optional stereo microphones. Wind-noise reduction for optional stereo microphones that support this feature can be enabled or disabled using microphone controls.

## Headphone Volume

MENU button ➡  movie shooting menu

Press  or  to adjust headphone volume.

# Timecode

MENU button →  movie shooting menu

Choose whether to record time codes giving the hour, minute, second, and frame number for each frame when recording movies. Time codes are available only with movies recorded in MOV format. Before using this feature, select [**Time zone and date**] in the setup menu and make sure that the camera clock is set to the correct time and date.

Option	Description
[Record timecodes]	<ul style="list-style-type: none"><li>• [<b>On</b>]: Record time codes. The time code appears in the monitor.</li><li>• [<b>On (with HDMI output)</b>]: Time codes will be included with footage saved to external recorders connected to the camera via an HDMI cable. The camera supports Atomos SHOGUN, NINJA, and SUMO-series Monitor recorders.</li><li>• [<b>Off</b>]: Time codes are not recorded.</li></ul>

Option	Description
[Count-up method]	<ul style="list-style-type: none"> <li>• <b>[Record run]</b>: Time codes are incremented only while recording is in progress.</li> <li>• <b>[Free run]</b>: Time codes are incremented continuously. Time codes continue to be incremented while the camera is off.</li> </ul>
[Timecode origin]	<ul style="list-style-type: none"> <li>• <b>[Reset]</b>: Reset the time code to 00:00:00.00.</li> <li>• <b>[Enter manually]</b>: Enter the hour, minute, second, and frame number manually.</li> <li>• <b>[Current time]</b>: Set the time code to the current time as reported by the camera clock.</li> </ul>
[Drop frame]	Select <b>[On]</b> to compensate for discrepancies between the frame count and the actual recording time at frame rates of 30 and 60 fps.

### ✓ HDMI Devices

Selecting **[On (with HDMI output)]** for **[Record timecodes]** may disrupt footage output to HDMI devices.



## ✎ Custom Settings: Fine-Tuning Camera Settings

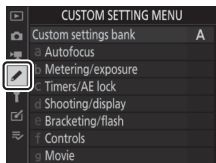

To view Custom Settings, select the ✎ tab in the camera menus.

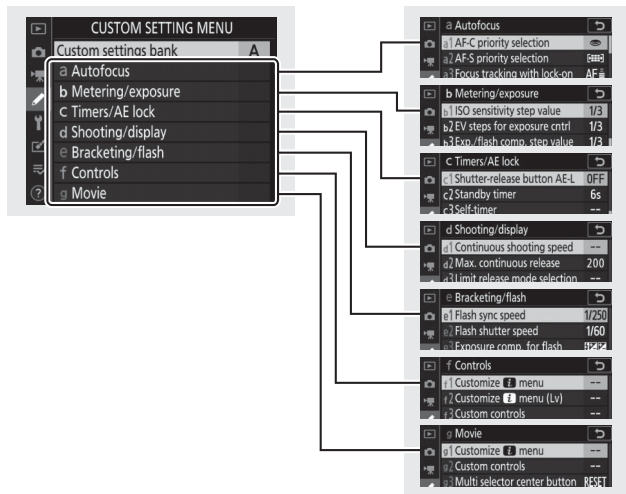

Custom Settings are used to customize camera settings to suit individual preferences. The Custom Settings menu is divided into two levels.





The following Custom Settings are available: <sup>1</sup>





Item			Item		
[Custom settings bank]		802	a10	[Custom groupings (C1/C2)]	812
<b>a [Autofocus]</b>					
a1	[AF-C priority selection]	804	a11	[Auto-area AF face detection]	812
a2	[AF-S priority selection]	805	a12	[Auto-area AF starting point]	813
a3	[Focus tracking with lock-on]	805	a13	[Focus point persistence]	813
a4	[Focus points used]	807	a14	[Limit AF-area mode selection]	814
a5	[Store points by orientation]	808	a15	[Autofocus mode restrictions]	815
a6	[AF activation]	810	a16	[Focus point wrap-around]	815
a7	[Single-point AF watch area]	811	a17	[Focus point options]	815
a8	[3D-tracking face-detection]	811	a18	[Manual focus ring in AF mode] <sup>2</sup>	817
a9	[Group-area AF face detection]	812			



Item		📖
<b>b [Metering/exposure]</b>		
b1	[ISO sensitivity step value]	818
b2	[EV steps for exposure cntrl]	818
b3	[Exp./flash comp. step value]	818
b4	[Easy exposure compensation]	819
b5	[Matrix metering]	820
b6	[Center-weighted area]	820
b7	[Fine-tune optimal exposure]	821
<b>c [Timers/AE lock]</b>		
c1	[Shutter-release button AE-L]	822
c2	[Standby timer]	822
c3	[Self-timer]	823
c4	[Monitor off delay]	823

Item		📖
<b>d [Shooting/display]</b>		
d1	[Continuous shooting speed]	824
d2	[Max. continuous release]	825
d3	[Limit release mode selection]	826
d4	[Sync. release mode options]	826
d5	[Exposure delay mode]	827
d6	[Electronic front-curtain shutter]	827
d7	[Extended shutter speeds (M)]	828
d8	[Limit selectable image area]	829
d9	[File number sequence]	830
d10	[Peaking highlights]	832
d11	[Framing grid display]	832
d12	[Rear control panel]	833
d13	[LCD illumination]	833
d14	[Live view in continuous mode]	835
d15	[Optical VR] <sup>3</sup>	835



Item		
<b>e [Bracketing/flash]</b>		
e1	[Flash sync speed]	836
e2	[Flash shutter speed]	838
e3	[Exposure comp. for flash]	838
e4	[Auto  ISO sensitivity control]	839
e5	[Flash burst priority]	840
e6	[Modeling flash]	840
e7	[Auto bracketing (mode M)]	841
e8	[Bracketing order]	842
e9	[Bracketing burst options]	843

Item		
<b>f [Controls]</b>		
f1	[Customize  menu]	844
f2	[Customize  menu (Lv)]	846
f3	[Custom controls]	850
f4	[Multi selector center button]	863
f5	[Shutter spd & aperture lock]	867
f6	[Customize command dials]	867
f7	[Multi selector]	872
f8	[Release button to use dial]	872
f9	[Reverse indicators]	873
f10	[Live view button options]	874
f11	[  switch]	874
f12	[Full-frame playback flicks]	875

Item		
<b>g [Movie]</b>		
g1	[ <b>Customize  menu</b> ]	877
g2	[ <b>Custom controls</b> ]	879
g3	[ <b>Multi selector center button</b> ]	884
g4	[ <b>Highlight display</b> ]	884

- 1 Items that have been modified from default values are indicated by asterisks ("\*").
- 2 Available with compatible lenses only.
- 3 Available only with compatible AF-P lenses not equipped with a vibration reduction switch.

# Custom Settings Bank

MENU button ➔  Custom Settings menu

Custom Settings are stored in one of four banks (banks “A” through “D”). Changes to settings in one bank have no effect on the others.

To store a particular combination of frequently-used settings, select one of the four banks using [**Custom Settings bank**] and adjust settings as desired.

## Renaming Custom Settings Banks



A descriptive caption can be added to the bank name (“A”, “B”, “C”, or “D”) by highlighting the bank and pressing . Captions can be up to 20 characters long.

### Custom Settings Banks

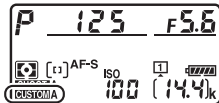
The information and top control panel displays show the current Custom Settings bank as **CUSTOM** followed by bank name (“A”, “B”, “C”, or “D”).



## Restoring Default Settings

You can restore default settings for a selected Custom Settings bank. To do so, highlight the bank and press  (FORMAT); a confirmation dialog will be displayed. Highlight [Yes] and press  to restore default settings for the selected bank.

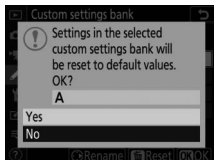
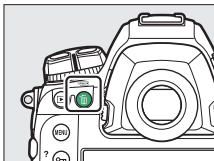





# a: Autofocus

## a1: AF-C Priority Selection

MENU button ➔  Custom Settings menu

Choose whether photos can be taken before the camera focuses when **AF-C** is selected.

Option	Description
 <b>[Release]</b>	Photos can be taken whenever the shutter-release button is pressed (release priority).
 <b>[Focus + release]</b>	Photos can be taken even when the camera is not in focus, but if the subject is dark or low contrast and the camera is in continuous-release mode, priority will be given to focus for the first shot in each series. For the remaining shots, priority will be given to frame rate regardless of focus. This helps ensure that the first shot in each series is in focus.
 <b>[Release + focus]</b>	Photos can be taken even when the camera is not in focus, but if the subject is dark or low contrast and the camera is in continuous-release mode, the frame advance rate will slow for improved focus. Focus is prioritized over frame rate.
 <b>[Focus]</b>	Photos can be taken only when the camera is in focus (focus priority).



Regardless of the option chosen for **[AF-C priority selection]**, focus will not lock when **AF-C** is chosen for autofocus mode; instead, the camera will continue to adjust focus until the shutter is released.



## a2: AF-S Priority Selection

MENU button ➡  Custom Settings menu

Choose whether photos can be taken before the camera focuses when **AF-S** is selected.

Option	Description
 [Release]	Photos can be taken whenever the shutter-release button is pressed (release priority).
 [Focus]	Photos can be taken only when the camera is in focus (focus priority).

Regardless of the option chosen for [**AF-S priority selection**], if **AF-S** is selected for autofocus mode, focus will lock when the shutter-release button is pressed halfway and remain locked while the button is kept in this position.

## a3: Focus Tracking with Lock-On

MENU button ➡  Custom Settings menu

Choose how quickly focus responds if something passes between the subject and the camera during viewfinder photography when **AF-C** is selected for autofocus mode.

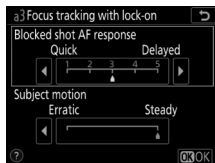

## Blocked Shot AF Response

Option	Description
[5 <b>(Delayed)</b> ]	Choose how quickly focus responds when something passes between the subject and the camera.
[4]	• Choose [5 <b>(Delayed)</b> ] to help maintain focus on your original subject.
[3]	
[2]	• Choose [1 <b>(Quick)</b> ] to make it easier to shift focus to objects crossing your field of view.
[1 <b>(Quick)</b> ]	

- Regardless of the option selected, blocked shot AF response functions in mode [3] when [3D-tracking] is selected for AF-area mode.
- If [Auto-area AF] is selected for AF-area mode, blocked shot AF response will function in mode [3] when [2] or [1 **(Quick)**] is selected.

## Subject Motion

Option	Description
[Steady]	Choose for smooth focus when photographing subjects that approach the camera at a steady pace.
[Erratic]	Choose for improved response when photographing subjects prone to sudden starts and stops.

## a4: Focus Points Used

MENU button ➡  Custom Settings menu

Choose the number of focus points available for manual focus-point selection when an option other than [**Auto-area AF**] is selected for AF-area mode during viewfinder photography.

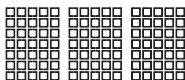

[105 points]



[27 points]



[15 points]

- Choose [**27 points**] or [**15 points**] for quick focus-point selection.
- Different groupings are available when [**Group-area AF**] is selected for AF-area mode.
- The groupings available when [**Group-area AF (C1)**] or [**Group-area AF (C2)**] is selected vary with the dimensions of the group.

## a5: Store Points by Orientation

MENU button ➡  Custom Settings menu

Choose whether separate focus points and AF-area modes can be selected for “wide” (landscape) orientation, for “tall” (portrait) orientation with the camera rotated 90° clockwise, and for “tall” orientation with the camera rotated 90° counterclockwise. The selected option applies only during viewfinder photography.

- Select [**Off**] to use the same focus point regardless of camera orientation.

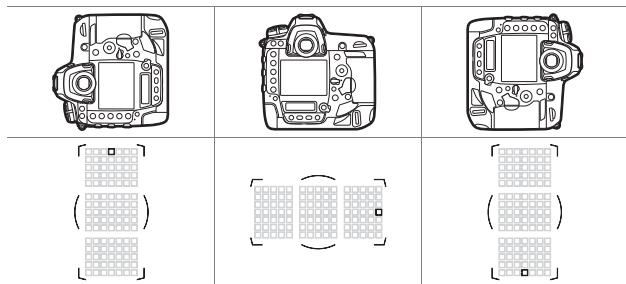

- Choose [**Focus point**] to enable separate focus-point selection. To enable separate selection of both the focus point and the AF-area mode, choose [**Focus point and AF-area mode**].

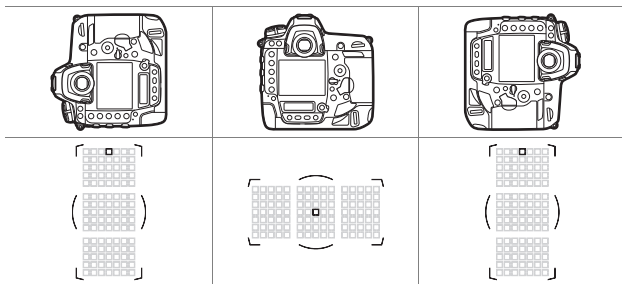

## a6: AF Activation

MENU button ➡  Custom Settings menu

Choose whether the shutter-release button can be used to focus.

Option	Description
[Shutter/ AF-ON]	The camera focuses when the shutter-release button is pressed halfway.
[AF-ON only]	The camera does not focus when the shutter-release button is pressed halfway.

- Highlighting [AF-ON only] and pressing  displays [Out-of-focus release] options.

Option	Description
[Enable]	Photos can be taken whenever the shutter-release button is pressed (release priority).
[Disable]	<ul style="list-style-type: none"><li>• Pictures can only be taken when the camera is able to focus; note that this only applies if:<ul style="list-style-type: none"><li>- [Focus] is selected for Custom Setting a1 [AF-C priority selection] and an option other than [Auto-area AF] is selected for AF-area mode, or</li><li>- [Focus] is selected for Custom Setting a2 [AF-S priority selection] and an option other than [Auto-area AF] is selected for AF-area mode.</li></ul></li><li>• Focus using the AF-ON button or other controls to which AF-ON has been assigned.</li></ul>

## a7: Single-Point AF Watch Area

MENU button ➡  Custom Settings menu

Choose the area from which data are obtained to assist focus when the shutter-release button is pressed halfway with **[Single-point AF]** or **[Dynamic-area AF]** selected for AF-area mode.

Option	Description
<b>[Normal]</b>	The camera locates subjects based solely on data from the vicinity of the selected point.
<b>[Wide]</b>	The camera uses data from surrounding areas to locate subjects slightly outside the selected focus point. Use for fast-moving subjects. <ul style="list-style-type: none"><li>• If <b>[Wide]</b> is selected, the AF-area mode indicators in the viewfinder and top control panel will show <b>S</b> when <b>[Single-point AF]</b> is chosen for AF-area mode.</li></ul>

## a8: 3D-Tracking Face-Detection

MENU button ➡  Custom Settings menu

Choose whether the camera detects and focuses on faces when **[3D-tracking]** is selected for AF-area mode.

## a9: Group-Area AF Face Detection

MENU button ➡  Custom Settings menu

Choose whether the camera detects and focuses on faces when [**Group-area AF**], [**Group-area AF (C1)**], or [**Group-area AF (C2)**] is selected for AF-area mode.

## a10: Custom Groupings (C1/C2)

MENU button ➡  Custom Settings menu

Choose the dimensions of the AF-area groupings for [**Group-area AF (C1)**] or [**Group-area AF (C2)**]; a total of 17 different options are available. For more information, see “Custom Focus Groups” (📖 167).

## a11: Auto-Area AF Face Detection

MENU button ➡  Custom Settings menu

Choose whether the camera detects and focuses on faces when [**Auto-area AF**] is selected for AF-area mode.



## a12: Auto-Area AF Starting Point

MENU button ➡  Custom Settings menu

Selecting [**Enable**] lets you use the multi selector to choose the starting focus point when **AF-C** and [**Auto-area AF**] are selected respectively for AF mode and AF-area mode. The camera will revert to normal auto-area AF once you have focused on the subject in the selected focus point.

## a13: Focus-Point Persistence

MENU button ➡  Custom Settings menu

Choose whether the focus point selected by the camera continues in use after you change AF-area modes using a control to which [**AF-area mode**] or [**AF-area mode + AF-ON**] has been assigned via Custom Setting f3 [**Custom controls**]. This only applies if you change AF-area modes while focusing with the shutter-release button pressed halfway.



- Focus-point persistence applies if while the control is pressed, you switch from an AF-area mode such as [**Auto-area AF**] in which the focus point is chosen automatically to a mode in which the focus point is selected manually.

Option	Description
[Auto]	The focus point last chosen by the camera before you switched AF-area modes remains in effect.
[Off]	The focus point last chosen by the user is restored.

## a14: Limit AF-Area Mode Selection

MENU button ➔  Custom Settings menu

Choose the AF-area modes that can be selected by pressing the AF-mode button and rotating the sub-command dial.

- Highlight an option and press  to select; selected items are marked with a check (). To deselect (remove the check from: ) a selected option, highlight it and press  again. Modes marked with a check () are available for selection via the sub-command dial.
- Press  to save changes when settings are complete.
- **[Limit AF-area mode selection]** applies only during viewfinder photography. It has no effect during live view.

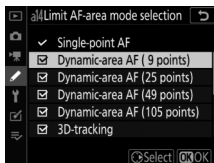

## a15: Autofocus Mode Restrictions

MENU button ➔  Custom Settings menu

Restrict the camera to a single autofocus mode during viewfinder photography. If **[AF-S]** or **[AF-C]** is selected, the remaining mode cannot be chosen using the AF-mode button and main command dial.

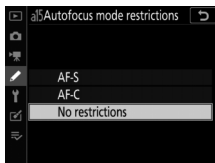

## a16: Focus Point Wrap-Around

MENU button ➔  Custom Settings menu

Choose whether focus-point selection “wraps around” from one edge of the display to another.

If **[Wrap]** is selected, focus-point selection will “wrap around” from top to bottom, bottom to top, right to left, and left to right, so that, for example, pressing  when a focus point at the right edge of the viewfinder display is highlighted selects the corresponding focus point at the left edge of the display.

## a17: Focus Point Options

MENU button ➔  Custom Settings menu

Choose from the viewfinder focus point display options below.

## Manual Focus Mode

Option	Description
[On]	The focus point is displayed at all times in manual focus mode.
[Off]	The focus point is displayed only during focus-point selection.

## Focus Point Brightness

Choose the brightness of the focus point display in the viewfinder.

## Dynamic-Area AF Assist

Choose whether the camera displays both the selected focus point and the surrounding focus points used to assist the focus operation in dynamic-area AF-area mode.

Option	Description
[On]	Display both the selected focus point and surrounding focus points.
[Off]	Display only the selected focus point.



[On] ([Dynamic-area  
AF (9 points)] selected)



[Off]

## a18: Manual Focus Ring in AF Mode

MENU button ➡  Custom Settings menu

This item is available with compatible lenses only. Choose whether the lens focus ring can be used for manual focus in autofocus mode.

Option	Description
<b>[Enable]</b>	Autofocus can be overridden by rotating the lens focus ring (autofocus with manual override). The focus ring can be used for manual focus while the shutter-release button is pressed halfway. To refocus using autofocus, lift your finger from the shutter-release button and then press it halfway again.
<b>[Disable]</b>	The lens focus ring cannot be used for manual focus in autofocus mode.

## **b: Metering/Exposure**

### **b1: ISO Sensitivity Step Value**

MENU button ➡  Custom Settings menu

Select the increments used when making adjustments to ISO sensitivity. If the value currently selected for ISO sensitivity is not available at the chosen setting, ISO sensitivity will be set to the nearest available value.

### **b2: EV Steps for Exposure Cntrl**

MENU button ➡  Custom Settings menu

Select the increments used for adjustments to shutter speed, aperture, and bracketing.

### **b3: Exp./Flash Comp. Step Value**

MENU button ➡  Custom Settings menu

Select the increments used when making adjustments to exposure and flash compensation.

## b4: Easy Exposure Compensation

MENU button ➡  Custom Settings menu

Choose whether adjustments to exposure compensation can be made by rotating a command dial without pressing the  button.



Option	Description
[On (Auto reset)]	Adjustments can be made using only a command dial. Settings selected with a command dial alone are reset when the camera is turned off or the standby timer expires.
[On]	Adjustments can be made using only a command dial. Exposure compensation is not reset when the camera is turned off or the standby timer expires.
[Off]	Adjustments are made by first pressing the  button and then rotating a command dial.

- This setting takes effect in modes **P**, **S**, and **A**. Easy exposure compensation is not available in mode **M**.
- The command dial used varies with the exposure mode.

## b5: Matrix Metering

MENU button ➡  Custom Settings menu

Choose whether [**Matrix metering**] assigns priority to faces detected by the camera. This setting applies only during viewfinder photography.

	Option	Description
	[ <b>Face detection on</b> ]	Matrix metering assigns priority to faces detected by the camera.
	[ <b>Face detection off</b> ]	Matrix metering does not assign priority to faces detected by the camera.

## b6: Center-Weighted Area

MENU button ➡  Custom Settings menu

When [**Center-weighted metering**] is selected, the camera assigns the greatest weight to an area in the center of the viewfinder when setting exposure. Custom Setting b6 [**Center-weighted area**] is used to choose the size of the area given the greatest weight when [**Center-weighted metering**] is selected.

- If a non-CPU or AF-S Fisheye NIKKOR 8–15 mm f/3.5–4.5E ED lens is attached, the size of the area is fixed at a diameter of 12 mm.



## b7: Fine-Tune Optimal Exposure

MENU button ➡  Custom Settings menu

Use this item to fine-tune the exposure value selected by the camera; exposure can be fine-tuned separately for each metering method. Exposure can be adjusted up for brighter exposures or down for darker exposures in the range +1 to -1 EV in steps of  $\frac{1}{6}$  EV. The default is 0.

---

### ✔ Fine-Tuning Exposure



- Custom Setting b7 [**Fine-tune optimal exposure**] fine-tunes exposure separately for each Custom Settings bank. Be aware of different fine-tuning values for Custom Setting b7 when switching banks.
  - Regardless of the option selected for Custom Setting b7 [**Fine-tune optimal exposure**], the exposure compensation icon () will not be displayed. The only way to determine how much exposure has been altered is to view the amount in the fine-tuning menu for Custom Setting b7.
  - The values selected are not affected by two-button resets.
-

## c: Timers/AE Lock

### c1: Shutter-Release Button AE-L

MENU button ➡  Custom Settings menu

Choose whether exposure locks when the shutter-release button is pressed.

Option	Description
 ON [On (half press)]	Pressing the shutter-release button halfway locks exposure.
 ON [On (burst mode)]	Exposure only locks while the shutter-release button is pressed all the way down.
[Off]	Pressing the shutter-release button does not lock exposure.

### c2: Standby Timer

MENU button ➡  Custom Settings menu



The camera continues to meter exposure for a set time after the shutter-release button is pressed halfway. Choose how long the camera continues to meter exposure when no operations are performed.

- The viewfinder display and the shutter speed and aperture displays in the top control panel turn off automatically when the standby timer expires.
- Choose a shorter standby timer delay for longer battery life.

### c3: Self-Timer

MENU button ➡  Custom Settings menu

Choose the length of the shutter-release delay, the number of shots taken, and the interval between shots in self-timer mode.

Option	Description
[Self-timer delay]	Choose the length of the shutter-release delay.
[Number of shots]	Press  and  to choose the number of shots taken each time the shutter-release button is pressed; choose from values of from 1 to 9.
[Interval between shots]	Choose the interval between shots when [Number of shots] is more than 1.

### c4: Monitor Off Delay

MENU button ➡  Custom Settings menu

Choose how long the monitor remains on when no operations are performed.

- Separate monitor off delays can be selected for [Playback], [Image review], [Menus], [Information display], and [Live view].
- Choose shorter monitor-off delays for greater battery endurance.

## d: Shooting/Display

### d1: Continuous Shooting Speed

MENU button ➡  Custom Settings menu

Choose the frame advance rate for **CH** (continuous high-speed) and **CL** (continuous low-speed) modes and during burst photography in mode **Q**.

Option	Description
[ <b>Continuous high-speed</b> ]	Set the frame advance rate for continuous high-speed ( <b>CH</b> ) mode to values between [ <b>14 fps</b> ] and [ <b>10 fps</b> ].
[ <b>Continuous low-speed</b> ]	Set the frame advance rate for continuous low-speed ( <b>CL</b> ) mode to values between [ <b>10 fps</b> ] and [ <b>1 fps</b> ].
[ <b>Quiet shutter release</b> ]	Set the frame advance rate for burst photography in mode <b>Q</b> to values between [ <b>5 fps</b> ] and [ <b>1 fps</b> ]. To take only one picture with each press of the shutter-release button, select [ <b>Single frame</b> ].

## d2: Max. Continuous Release

MENU button ➡  Custom Settings menu

The maximum number of shots that can be taken in a single burst in continuous release modes can be set to any value between 1 and 200.

- Note that regardless of the option selected, there is no limit to the number of photos that can be taken in a single burst when a shutter speed of 4 s or slower is selected in mode **S** or **M**.

---



### The Memory Buffer



Custom Setting d2 [**Max. continuous release**] is used to select the number of shots that can be taken in a single burst. The number of shots that can be taken before the memory buffer fills and shooting slows varies with image quality and other settings. When the buffer is full, the camera will display **r00** and the frame advance rate will drop.

---

### d3: Limit Release Mode Selection

MENU button ➔  Custom Settings menu

Choose the release modes that can be accessed by pressing the  button and rotating the main command dial when the release mode dial is rotated to .

- Highlight an option and press  to select; selected items are marked with a check (). To deselect (remove the check from: ) a selected option, highlight it and press  again. Modes marked with a check () are available for selection via the main command dial.

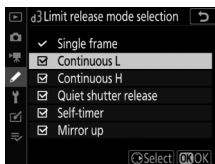

- Press  to save changes when settings are complete.

### d4: Sync. Release Mode Options

MENU button ➔  Custom Settings menu

Choose whether the shutters on remote cameras controlled via an optional wireless transmitter or wireless remote controller synchronize with the shutter on the master camera.

## d5: Exposure Delay Mode

MENU button →  Custom Settings menu

In situations where the slightest camera movement can blur pictures, shutter release can be delayed by from about 0.2 to 3 seconds after the mirror is raised.

## d6: Electronic Front-Curtain Shutter

MENU button →  Custom Settings menu

Enable or disable the electronic front-curtain shutter. Enabling the electronic front-curtain shutter helps reduce blur caused by camera shake. The electronic front-curtain shutter is available in **Q** and **MUP** release modes.

Option	Description
[Enable]	Enable the electronic front-curtain shutter.
[Disable]	Use the mechanical shutter.

---

## ✓ The Electronic Front-Curtain Shutter

- Pictures taken with lenses of types other than G, E, or D may contain “noise” such as lines or fog. Select **[Disable]** should you notice this to be the case.
  - Regardless of the option selected, the camera uses the mechanical shutter in release modes other than **Q** and **MUP**.
  - The fastest shutter speed and maximum ISO sensitivity available with the electronic front-curtain shutter are  $1/2000$  s and ISO 102400, respectively.
- 

## d7: Extended Shutter Speeds (M)

MENU button ➡  Custom Settings menu

Extend the range of shutter speeds available in mode **M**; the slowest shutter speed available when **[On]** is selected is 900 s (15 minutes). Extended shutter speeds can be used for pictures of the night sky and other long exposures.



- To use extended shutter speeds, choose **[On]** and select a shutter speed of 60 s or slower.



## d8: Limit Selectable Image Area

MENU button ➔  Custom Settings menu

Choose the options that can be accessed by rotating a command dial while pressing a control to which [**Choose image area**] has been assigned using Custom Setting f3 [**Custom controls**].

- Highlight an option and press  to select; selected items are marked with a check (). To deselect (remove the check from: ) a selected option, highlight it and press  again. Image area options marked with a check () are available for selection via a command dial.
- Press  to save changes when settings are complete.

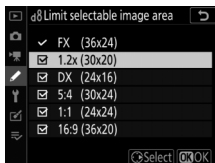

## d9: File Number Sequence

MENU button ➡  Custom Settings menu

Choose a file numbering option.

Option	Description
[On]	When a new folder is created or a new memory card is inserted in the camera, file numbering will continue from the last number used. This simplifies file management by minimizing the occurrence of duplicate file names when multiple cards are used.
[Off]	When a new folder is created or a new memory card is inserted, file numbering restarts from 0001. If the current folder already contains images, file numbering will instead continue from the highest file number in the current folder. If you select [Off] after selecting [On], the camera will store the current file number. File numbering will resume from the previously-stored value the next time [On] is selected.
[Reset]	Reset the file numbering for [On]. If the current folder is empty, file numbering will restart from 0001 with the next picture taken. If the current folder contains images, the next picture taken will be assigned a file number by adding one to the highest file number in the current folder.

---

## ✔ File Number Sequence

- If a picture is taken when the current folder contains a picture numbered 9999, a new folder will be created and file numbering will restart from 0001.
- When the current folder number reaches 999, the camera will no longer be able to create new folders and the shutter release will be disabled if:
  - the current folder contains 5000 pictures (in addition, movie recording will be disabled if the camera calculates that the number of files needed to record a movie of the maximum length would result in the folder containing over 5000 files), or
  - the current folder contains a picture numbered 9999 (in addition, movie recording will be disabled if the camera calculates that the number of files needed to record a movie of the maximum length would result in a file numbered over 9999).

To resume shooting, choose **[Reset]** for Custom Setting d9 **[File number sequence]** and then either format the current memory card or insert a new memory card.

## ✔ Folder Numbering

- If a picture is taken when the current folder contains 5000 pictures or a picture numbered 9999, a new folder will be created and selected as the current folder.
- The new folder is assigned a number one higher than current folder number. If a folder with that number already exists, the new folder will be assigned the lowest available folder number.

## d10: Peaking Highlights

MENU button ➡  Custom Settings menu

When focus peaking is enabled in manual focus mode, objects that are in focus are indicated by colored outlines in the display. You can choose the color.

Option	Description
[Peaking level]	Choose from [ <b>3 (high sensitivity)</b> ], [ <b>2 (standard)</b> ], [ <b>1 (low sensitivity)</b> ], and [ <b>Off</b> ]. The higher the value, the greater the depth that will be shown as being in focus.
[Peaking highlight color]	Choose a peaking highlight color from [ <b>Red</b> ], [ <b>Yellow</b> ], [ <b>Blue</b> ], and [ <b>White</b> ].

## d11: Framing Grid Display

MENU button ➡  Custom Settings menu

Choose whether to display a grid for reference when framing shots.

## d12: Rear Control Panel

MENU button ➡  Custom Settings menu

Choose the information displayed in the rear control panel in the location shown.



Option	Description
[Release mode]	The camera displays the current release mode.
[Frame count]	The camera displays the number of pictures in the current folder.

## d13: LCD Illumination

MENU button ➡  Custom Settings menu

Choose when the control panel and button backlights light.

- If [**Off**] is selected, the backlights will light when the power switch is rotated to . The backlights turn off when the shutter-release button is pressed.
- If [**On**] is selected, the backlights will light while the standby timer is active. Note that this increases the drain on the battery. The backlights will turn off while the shutter-release button is pressed, but will turn on again when the button is released.

## ✔ Button Backlights

The following are equipped with backlights:

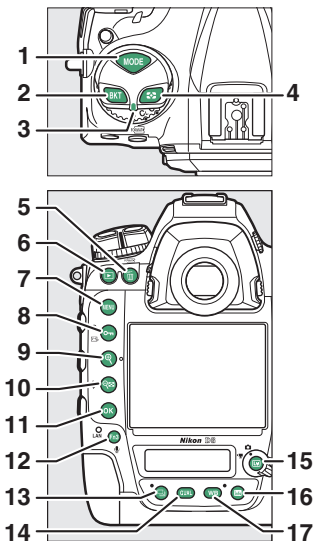

- 1 **MODE** button
- 2 **BKT** button
- 3 Release mode dial pointer
- 4 button
- 5 button
- 6 button
- 7 **MENU** button
- 8 button (**LV3**/?)
- 9 button
- 10 button
- 11 button
- 12 **Fn3** () button
- 13 button
- 14 **QUAL** button
- 15 button
- 16 button
- 17 **WB** button

## d14: Live View in Continuous Mode

MENU button ➡  Custom Settings menu

Choose whether the monitor remains on in live view while burst photography is in progress. If [**Off**] is selected, both the monitor and the monitor backlight will turn off during exposures.

## d15: Optical VR

MENU button ➡  Custom Settings menu

This item is available only with compatible AF-P lenses not equipped with a vibration reduction switch. Selecting [**On**] enables vibration reduction, which takes effect whenever the shutter-release button is pressed halfway. Select [**Off**] to disable vibration reduction.

## e: Bracketing/Flash

### e1: Flash Sync Speed

MENU button →  Custom Settings menu

Choose the flash sync speed.

Option	Description
[1/250 s (Auto FP)]	<p>Auto FP high-speed sync is enabled with compatible flash units and the maximum sync speed for other flash units is set to <math>1/250</math> s.</p> <ul style="list-style-type: none"><li>• When the camera shows a shutter speed of <math>1/250</math> s in mode <b>P</b> or <b>A</b>, auto FP high-speed sync will be activated if the actual shutter speed is faster than <math>1/250</math> s. If the flash supports auto FP high-speed sync, the camera can select shutter speeds as fast as <math>1/8000</math> s.</li><li>• In modes <b>S</b> and <b>M</b>, the user can select shutter speeds as fast as <math>1/8000</math> s when using flash units that support auto FP high-speed sync.</li></ul>



Option	Description
[1/250 s]	Flash sync speed set to selected value, which can be from $1/250$ to $1/60$ s.
[1/200 s]	
[1/160 s]	
[1/125 s]	
[1/100 s]	
[1/80 s]	
[1/60 s]	

### ✔ Fixing Shutter Speed at the Flash Sync Speed Limit

In modes **S** and **M**, shutter speed can be fixed at the value selected for Custom Setting e1 [**Flash sync speed**] by selecting the next shutter speed after the slowest possible shutter speed (30 s or -). An **X** (flash sync indicator) will be displayed in the viewfinder and top control panel together with the flash sync speed.

### ✔ Auto FP High-Speed Sync

- Auto FP high-speed sync allows the flash to be used at the highest shutter speed supported by the camera. When [**1/250 s (Auto FP)**] is selected, the camera automatically enables auto FP high-speed sync at shutter speeds faster than the flash sync speed. This makes it possible to choose the maximum aperture for reduced depth of field even when the subject is backlit in bright sunlight.
- The flash information display shows “FP” when [**1/250 s (Auto FP)**] is selected.

## e2: Flash Shutter Speed

MENU button ➡  Custom Settings menu



Choose the slowest shutter speed available with a flash in modes **P** and **A**.

Regardless of the setting chosen for e2 [**Flash shutter speed**], shutter speeds can be as slow as 30 s in modes **S** and **M** or at flash settings of slow sync, slow rear-curtain sync, or red-eye reduction with slow sync.

## e3: Exposure Comp. for Flash

MENU button ➡  Custom Settings menu



Choose how the camera adjusts flash level when exposure compensation is used.

	Option	Description
	[ <b>Entire frame</b> ]	The camera adjusts both the flash level and exposure. This changes the exposure for the entire frame.
	[ <b>Background only</b> ]	Exposure compensation is adjusted for the background only.

## e4: Auto ISO Sensitivity Control

MENU button   Custom Settings menu



Choose how the camera adjusts flash level when auto ISO sensitivity control is enabled.

	Option	Description
	[Subject and background]	The camera takes both the main subject and background lighting into account when adjusting ISO sensitivity.
	[Subject only]	ISO sensitivity is adjusted only to ensure that the main subject is correctly exposed.

## e5: Flash Burst Priority

MENU button ➡  Custom Settings menu

Choose whether optional flash units emit monitor pre-flashes before each shot during burst photography in modes **CL** and **CH**.

Option	Description
 <b>[Prioritize frame advance rate]</b>	The flash unit emits a monitor pre-flash before the first shot in each sequence and locks output at the metered value for the remaining shots. The frame advance rate drops less than when <b>[Prioritize precise flash control]</b> is selected. <ul style="list-style-type: none"><li>• An FV lock icon () is displayed in the viewfinder during burst photography.</li></ul>
 <b>[Prioritize precise flash control]</b>	The flash unit emits a monitor pre-flash before each shot and adjusts flash output as required. The frame advance rate may drop in some circumstances.

## e6: Modeling Flash









MENU button ➡  Custom Settings menu

Select **[On]** to enable the modeling flash emitted if the **Pv** button is pressed when the camera is used with an optional flash unit that supports the Nikon Creative Lighting system.

## e7: Auto Bracketing (Mode M)

MENU button ➡  Custom Settings menu

Custom Setting e7 [**Auto bracketing (Mode M)**] determines the settings affected when exposure or flash bracketing is enabled in mode **M** using [**Auto bracketing set**].



Custom Setting e7 [Auto bracketing (Mode M)]		Photo shooting menu > [Auto bracketing set]	
		AE & flash *	AE only *
 	[Flash/speed]	Shutter speed and flash level	Shutter speed
  	[Flash/speed/aperture]	Shutter speed, aperture, and flash level	Shutter speed and aperture
  	[Flash/aperture]	Aperture and flash level	Aperture
	[Flash only]	Flash level	—

\* If a flash is not used when [On] is selected for [**Auto ISO sensitivity control**] and [Flash/speed], [Flash/speed/aperture], or [Flash/aperture] is selected for Custom Setting e7, ISO sensitivity will be fixed at the value for the first shot in each bracketing sequence.



## Flash Bracketing

Flash bracketing is performed only with i-TTL or A (auto aperture) flash control.

## e8: Bracketing Order

MENU button   Custom Settings menu

Choose the order in which the shots in the bracketing program are taken.

	Option	Description
	[MTR > under > over]	The unmodified shot is taken first, followed by the shot with the lowest value, followed by the shot with the highest value.
	[Under > MTR > over]	Shooting proceeds in order from the lowest to the highest value.

- Custom Setting e8 [**Bracketing order**] has no effect on the order of the shots taken when [**ADL bracketing**] is selected for [**Auto bracketing**] > [**Auto bracketing set**] in the photo shooting menu.

## e9: Bracketing Burst Options

MENU button ➡  Custom Settings menu

Choose whether, during bracketing, the camera continues to take pictures while the shutter-release button is pressed all the way down.









Option	Description
<b>[Enable]</b>	<p>The camera takes pictures continuously while the shutter-release button is pressed all the way down.</p> <ul style="list-style-type: none"><li>• In release modes <b>S</b> and <b>Q</b>, shooting will end after all the shots in the bracketing sequence have been taken.</li><li>• In modes <b>CH</b> and <b>CL</b> and during burst photography in mode <b>Q</b>, the camera will repeat the bracketing sequence while the shutter-release button is pressed all the way down.</li><li>• If <b>[WB bracketing]</b> is selected for <b>[Auto bracketing set]</b> in the photo shooting menu, the camera will take pictures while the shutter-release button is pressed all the way down and apply white balance bracketing to each shot regardless of the option chosen for release mode.</li></ul>
<b>[Disable]</b>	<ul style="list-style-type: none"><li>• In release modes <b>S</b> and <b>Q</b>, the camera will take one picture each time the shutter-release button is pressed.</li><li>• If the shutter-release button is kept pressed in modes <b>CH</b> and <b>CL</b> and during burst photography in mode <b>Q</b>, shooting will pause after all the shots in the bracketing sequence have been taken. Shooting will resume the next time the shutter-release button is pressed.</li></ul>

# f: Controls







## f1: Customize Menu









MENU button →  Custom Settings menu

Choose the items listed in the **i** menu displayed when the **i** button is pressed during viewfinder photography. For information on customizing the **i** menu, see “Customizing the **i** Menu: Customize **i** Menu” ( 377).

	Item			Item	
	[Photo shooting menu bank]	752		[Set Picture Control]	271
	[Choose image area]	136	RGB	[Color space]	765
QUAL	[Image quality]	142		[Active D-Lighting]	281
SIZE	[Image size]	145		[Long exposure NR]	767
	[Exposure compensation]	199	ISO NR	[High ISO NR]	768
ISO	[ISO sensitivity settings]	213		[Metering]	178
WB	[White balance]	221			













Item		📖
	[Flash mode]	648
	[Flash compensation]	653
GRP 	[Group flash options]	670
AF	[Autofocus mode]	149
[+]	[AF-area mode]	153
BKT	[Auto bracketing]	249
	[Multiple exposure]	318
HDR	[HDR (high dynamic range)]	283
	[Interval timer shooting]	331
	[Time-lapse movie]	348









Item		📖
	[Focus shift shooting]	360
	[Select custom settings bank]	802
AF LOCK-ON 	[Focus tracking with lock-on]	805
	[Custom controls]	850
	[Exposure delay mode]	827
	[Electronic front-curtain shutter]	827
	[Bluetooth connection]	929
	[Wi-Fi connection]	932
	[Wired LAN/WT]	937





## f2: Customize Menu (Lv)









MENU button   Custom Settings menu

Choose the items listed in the  menu displayed when the  button is pressed during live view. For information on customizing the  menu, see “Customizing the  Menu: Customize  Menu” ( 377).

	Item	
	[Choose image area]	136
QUAL	[Image quality]	142
SIZE	[Image size]	145
	[Exposure compensation]	199
ISO	[ISO sensitivity settings]	213
WB	[White balance]	221
	[Set Picture Control]	271
RGB	[Color space]	765
	[Active D-Lighting]	281

	Item	
	[Long exposure NR]	767
ISO NR	[High ISO NR]	768
	[Metering]	178
	[Flash mode]	648
	[Flash compensation]	653
GRP 	[Group flash options]	670
AF	[Autofocus mode]	151
	[AF-area mode]	160
BKT	[Auto bracketing]	249
	[Multiple exposure]	318

Item		📖
HDR	[HDR (high dynamic range)]	283
	[Interval timer shooting]	331
	[Time-lapse movie]	348
	[Focus shift shooting]	360
	[Silent live view photography]	374
	[Custom controls]	850

Item		📖
	[Exposure delay mode]	827
	[Electronic front-curtain shutter]	827
	[Peaking highlights]	832
	[Monitor brightness]	889
LvWB	[Photo live view display WB]	848
	[Bluetooth connection]	929
	[Wi-Fi connection]	932
	[Wired LAN/WT]	937
	[Split-screen display zoom]	849

## **Photo Live View Display WB**

In live view, white balance for the monitor (monitor hue) can be set separately from the white balance for photography (photographic white balance). Hues in the monitor may differ from those in pictures taken with an option such as [**Flash**] or [**Preset manual**] selected for photographic white balance. Matching monitor hue to photographic white balance gives you a more accurate preview of how pictures will turn out.

<b>Option</b>	<b>Description</b>
[None]	Monitor hue matches photographic white balance.
[Auto]	The monitor uses [ <b>Keep white (reduce warm colors)</b> ] white balance.
[ <b>Choose color temperature</b> ]	Choose a color temperature for the monitor display.

Monitor white balance is reset when the camera is turned off.

## Split-Screen Display Zoom

Display two areas, aligned horizontally but in different parts of the frame, side-by-side at a high zoom ratio. This makes it easier to level photographs of buildings or other wide objects.

Selecting this option splits the display into two boxes arranged side-by-side showing the two areas at a high zoom ratio (split-screen display zoom). The boxes display magnified views of the areas indicated by the frames (□) in the navigation window.

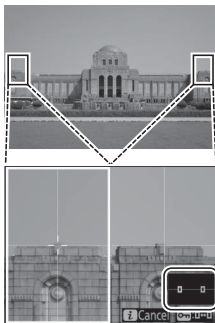

- Use the and buttons to zoom in and out.
- Press or to scroll the selected area left or right. Use the button to select a box.
- Press or to scroll both areas up or down simultaneously.
- To focus on the subject at the center of the selected area, press the shutter-release button halfway.
- To exit split-screen display zoom, press the button.









## f3: Custom Controls







MENU button ➔  Custom Settings menu

Choose the operations performed during still photography either by pressing camera controls or by pressing controls and rotating command dials.

- Choose the roles played by the controls below. Highlight the desired control and press .









	[Preview button]
	[Fn1 button]
	[Fn2 button]
	[Fn button for vertical shooting]
	[Fn3 button]
	[AF-ON button]
	[Sub-selector]
	[Sub-selector center]







	[AF-ON button for vertical shooting]
	[Multi selector for vertical shooting]
	[Metering button]
	[BKT button]
	[Movie record button]
	[Lens focus function buttons]







- The roles that can be assigned are listed below. The roles available vary with the control.

	Role	Description
PRE <sup>(*)</sup>	<b>[Preset focus point]</b>	<p>Pressing the control selects a preset focus point.</p> <ul style="list-style-type: none"> <li>• To choose the point, highlight it, hold the control, and press the AF-mode button until the focus point flashes.</li> <li>• Separate focus points can be selected for “wide” (landscape) orientation and for each of the two “tall” (portrait) orientations if an option other than <b>[Off]</b> is selected for Custom Setting a5 <b>[Store points by orientation]</b>.</li> <li>• The behavior of the selected control can be chosen by pressing  when <b>[Preset focus point]</b> is highlighted. <ul style="list-style-type: none"> <li>- <b>[Press to recall focus point]</b>: Pressing the control recalls the preset focus point.</li> <li>- <b>[Hold to recall focus point]</b>: The preset focus point is selected while the control is pressed. Releasing the control restores the focus point selected before the control was pressed.</li> </ul> </li> </ul>





Role	Description
[□]	<p><b>[AF-area mode]</b></p> <p>Holding the control selects a preset AF-area mode. The mode previously in effect is restored when the control is released.</p> <ul style="list-style-type: none"> <li>To choose the AF-area mode, press  when <b>[AF-area mode]</b> is highlighted.</li> </ul>
	<p><b>[AF-area mode + AF-ON]</b></p> <p>Holding the control selects a preset AF-area mode and initiates autofocus. The AF-area mode previously in effect is restored when the control is released.</p> <ul style="list-style-type: none"> <li>To choose the AF-area mode, press  when <b>[AF-area mode + AF-ON]</b> is highlighted.</li> </ul>
	<p><b>[AF-ON]</b></p> <p>Pressing the control initiates autofocus, duplicating the function of the <b>AF-ON</b> button.</p>
	<p><b>[AF lock only]</b></p> <p>Focus locks while the control is pressed.</p>
	<p><b>[AE lock (Hold)]</b></p> <p>Exposure locks when the control is pressed. Exposure lock does not end when the shutter is released. Exposure remains locked until the control is pressed a second time or the standby timer expires.</p>
	<p><b>[AE/AWB lock (hold)]</b></p> <p>Exposure locks when the control is pressed. If <b>[Auto]</b> or <b>[Natural light auto]</b> is selected for white balance, white balance will lock at the value for the most recent photograph (white-balance lock). Exposure and white-balance lock do not end when the shutter is released. The lock will however be released when the control is pressed a second time or the standby timer expires.</p>















	Role	Description
	[ <b>AE lock (Reset on release)</b> ]	Exposure locks when the control is pressed. Exposure remains locked until the control is pressed a second time, the shutter is released, or the standby timer expires.
	[ <b>AE lock only</b> ]	Exposure locks while the control is pressed.
	[ <b>AE/AF lock</b> ]	Focus and exposure lock while the control is pressed.
	[ <b>FV lock</b> ]	Press the control to lock flash value for optional flash units; press again to cancel FV lock.
	[ <b>⚡ Disable/enable</b> ]	If the flash is currently enabled, it will be disabled while the control is pressed. If the flash is currently off, front-curtain sync will be selected while the control is pressed.
	[ <b>Preview</b> ]	<ul style="list-style-type: none"> <li>• <b>Viewfinder photography:</b> Hold the control to stop aperture down and preview depth of field.</li> <li>• <b>Live view:</b> Press the control to stop aperture down and preview focus. Press the control again to restore the previously-selected aperture value.</li> </ul>







Role	Description
 <p data-bbox="171 544 296 634"><b>[Recall shooting functions]</b></p>	<p data-bbox="368 107 876 165">Hold the control to recall previously-selected settings.</p> <ul style="list-style-type: none"> <li data-bbox="368 171 912 331">• To choose the settings recalled, press  when <b>[Recall shooting functions]</b> is highlighted. <ul style="list-style-type: none"> <li data-bbox="389 238 912 331">- Press  or  to highlight items and press  to view options. Press  to save changes and exit.</li> <li data-bbox="389 337 907 433">- To store current camera settings for later recall using this option, select <b>[Save current settings]</b>.</li> </ul> </li> <li data-bbox="368 439 912 739">• Settings such as shutter speed and aperture can be changed by holding the control and rotating a command dial. <ul style="list-style-type: none"> <li data-bbox="389 541 888 599">- In mode <b>P</b>, you can adjust flexible program settings.</li> <li data-bbox="389 605 912 739">- If an option other than <b>[Off]</b> is selected for Custom Setting b4 <b>[Easy exposure compensation]</b>, exposure compensation can be adjusted by rotating a command dial.</li> </ul> </li> <li data-bbox="368 745 897 1074">• Settings cannot be saved or recalled if: <ul style="list-style-type: none"> <li data-bbox="389 774 891 832">- a non-CPU lens or a PC Micro-Nikkor 85mm f/2.8D lens is attached,</li> <li data-bbox="389 838 897 972">- a CPU lens with an aperture ring is attached with <b>[Aperture ring]</b> selected for Custom Setting f6 <b>[Customize command dials]</b> &gt; <b>[Aperture setting]</b>, or</li> <li data-bbox="389 978 897 1074">- a CPU lens with an aperture ring is attached without locking the ring at minimum aperture.</li> </ul> </li> </ul>



Role	Description
<b>BKT</b>  [Bracketing burst]	<ul style="list-style-type: none"> <li>• If the control is pressed when an option other than [WB bracketing] is selected for [Auto bracketing] &gt; [Auto bracketing set] in the photo shooting menu in release mode <b>CH</b> or <b>CL</b> or during burst photography in mode <b>Q</b>, the camera will take all the shots in the current bracketing program and repeat the bracketing burst while the shutter-release button is pressed. In release modes <b>S</b> and <b>Q</b>, shooting will end after the first bracketing burst.</li> <li>• If the control is kept pressed when [WB bracketing] is selected for [Auto bracketing] &gt; [Auto bracketing set], the camera will take pictures while the shutter-release button is pressed and apply white balance bracketing to each shot.</li> <li>• Selecting [Enable] for Custom Setting e9 [Bracketing burst options] is equivalent to keeping the control pressed at all times.</li> </ul>

Role	Description
 <p data-bbox="171 492 339 550">[Sync. release selection]</p>	<p data-bbox="368 106 909 331">When an optional wireless transmitter or wireless remote controller is connected, the control can be used to toggle between remote release and master or synchronized release. The options available depend on the setting chosen for Custom Setting d4 [<b>Sync. release mode options</b>].</p> <ul style="list-style-type: none"> <li data-bbox="368 339 868 433">• The following options are available when [<b>Sync</b>] is selected for [<b>Sync. release mode options</b>]: <ul style="list-style-type: none"> <li data-bbox="389 441 705 467">-  [<b>Master release only</b>] Keep the control pressed to take pictures with the master camera only.</li> <li data-bbox="389 543 715 569">-  [<b>Remote release only</b>] Keep the control pressed to take pictures only with the remote cameras.</li> </ul> </li> <li data-bbox="368 645 902 739">• The following options are available when [<b>No sync</b>] is selected for [<b>Sync. release mode options</b>]: <ul style="list-style-type: none"> <li data-bbox="389 746 731 773">-  [<b>Synchronized release</b>] Keep the control pressed to synchronize the releases on the master and remote cameras.</li> <li data-bbox="389 848 715 875">-  [<b>Remote release only</b>] Keep the control pressed to take pictures only with the remote cameras.</li> </ul> </li> </ul>

Role		Description
 [+ <b>NEF (RAW)</b> ]		<ul style="list-style-type: none"> <li>• If a JPEG option is currently selected for image quality, an NEF (RAW) copy will be recorded with the next picture taken after the control is pressed (until the picture is taken, “RAW” will appear in the image-quality display in the rear control panel). The original image quality setting will be restored when you remove your finger from the shutter-release button or press the control again, canceling [+ <b>NEF (RAW)</b>].</li> <li>• NEF (RAW) copies are recorded at the settings currently selected for [<b>NEF (RAW) recording</b>] and [<b>Image size</b>] &gt; [<b>NEF (RAW)</b>] in the photo shooting menu.</li> </ul>
	[ <b>Framing grid display</b> ]	Press the control to display a framing grid in the viewfinder or monitor. Press the control again to turn the display off.
	[ <b>Viewfinder virtual horizon</b> ]	Press the control to view a virtual horizon display in the viewfinder. Press the control again to turn the display off.
	[ <b>Voice memo</b> ]	Use the control for voice memo operations.
	[ <b>Wired LAN/WT</b> ]	If you have previously connected to networks via Ethernet or using a wireless transmitter, you can press the control to connect to the network last accessed. If you have not previously connected to a network, the network settings dialog will be displayed.
	[ <b>MY MENU</b> ]	Press the control to display “MY MENU”.

	Role	Description
	[ <b>Access top item in MY MENU</b> ]	Press the control to jump to the top item in “MY MENU.” Select this option for quick access to a frequently-used menu item.
	[ <b>Playback</b> ]	Press the control to start playback.
	[ <b>Filtered playback</b> ]	Press the control to view only pictures that meet the criteria selected for [ <b>Filtered playback criteria</b> ] in the playback menu.
	[ <b>Select to send (wired LAN/WT)</b> ]	Press the control during full-frame playback to select the current picture for upload to a computer via Ethernet or using a wireless transmitter.
RESET	[ <b>Select center focus point</b> ]	Press the control to select the center focus point.
= 	[ <b>Same as AF-ON button</b> ]	The control performs the role currently selected for the <b>AF-ON</b> button.
SHOOT	[ <b>Photo shooting menu bank</b> ]	Press the control and rotate a command dial to choose the photo shooting menu bank.
AF/[+]	[ <b>AF mode/AF-area mode</b> ]	Hold the control and rotate the main command dial to choose the autofocus mode, the sub-command dial to choose the AF-area mode.
	[ <b>Choose image area</b> ]	Press the control and rotate a command dial to choose the image area. The options available for selection can be chosen using Custom Setting d8 [ <b>Limit selectable image area</b> ].

	Role	Description
	[ <b>Active D-Lighting</b> ]	Press the control and rotate a command dial to adjust Active D-Lighting.
	[ <b>Exposure delay mode</b> ]	Press the control and rotate a command dial to choose the shutter-release delay.
	[ <b>Shutter spd &amp; aperture lock</b> ]	Press the control and rotate the main command dial to lock shutter speed (modes <b>S</b> and <b>M</b> ). To lock aperture (modes <b>A</b> and <b>M</b> ), press the control and rotate the sub-command dial.
	[ <b>1 step spd/aperture</b> ]	Make adjustments to shutter speed and aperture in increments of 1 EV, regardless of the option selected for Custom Setting b2 [ <b>EV steps for exposure cntrl</b> ]. <ul style="list-style-type: none"> <li>• In modes <b>S</b> and <b>M</b>, shutter speed can be adjusted in increments of 1 EV by holding the control and rotating the main command dial.</li> <li>• In modes <b>A</b> and <b>M</b>, aperture can be adjusted in increments of 1 EV by holding the control and rotating the sub-command dial.</li> </ul>
	[ <b>Choose non-CPU lens number</b> ]	Press the control and rotate a command dial to choose a lens number saved using the [ <b>Non-CPU lens data</b> ] item in the setup menu.
	[ <b>Exposure mode</b> ]	Press the control and rotate the main command dial to choose the exposure mode.
	[ <b>Exposure compensation</b> ]	Press the control and rotate the main command dial to adjust exposure compensation.

Role		Description
ISO	[ISO sensitivity]	Press the control and rotate the main command dial to choose a value for ISO sensitivity. Press the control and rotate the sub-command dial to adjust auto ISO sensitivity control settings.
	[Metering]	Press the control and rotate a command dial to choose a metering option.
★	[Rating]	To rate the current picture in playback mode, press the control and rotate the main command dial. <ul style="list-style-type: none"> <li>To display rating options, highlight [Rating] and press . If an option other than [None] is selected, the chosen rating can be assigned to pictures simply by pressing the selected control. Pressing the control again selects a “no star” rating.</li> </ul>
BKT	[Auto bracketing]	Press the control and rotate the main command dial to choose the number of shots and the sub-command dial to select the bracketing increment or Active D-Lighting amount.
	[Multiple exposure]	Press the control and rotate the main command dial to choose the mode and the sub-command dial to choose the number of shots.
HDR	[HDR (high dynamic range)]	Press the control and rotate the main command dial to choose the mode and the sub-command dial to choose the exposure differential.



Role	Description
= ⊕ <b>[Same as multi selector]</b>	<p>Pressing the selected control up, down, left, or right has the same effect as pressing ⊕, ⊖, ⊗, or ⊘ on the multi selector.</p> <ul style="list-style-type: none"> <li>• If this option is assigned to the sub-selector, the role played by the sub-selector during playback zoom can be chosen from <b>[Scroll]</b> and <b>[Display next/previous frame]</b>.</li> <li>• If this option is assigned to the multi selector for vertical shooting, you can select the role played by the control during playback using <b>[Photo info/playback]</b>. If <b>[Info ⊕/Playback ⊗]</b> is selected, you can press the control up or down to display other pictures, left or right to view photo info.</li> <li>• If this option is assigned to the multi selector for vertical shooting, the role played by the center of the multi selector for vertical shooting is the same as that performed by the center of the multi selector.</li> </ul>
[r] <b>[Focus point selection]</b>	<p>The selected control can be used to choose the focus point.</p> <ul style="list-style-type: none"> <li>• In the case of the multi selector for vertical shooting, the center of the selector plays the role chosen for <b>[Sub-selector center]</b>.</li> </ul>
<b>[None]</b>	<p>The control has no effect.</p>



## ✔ Virtual Horizon

If you press a control to which [Press] > [Viewfinder virtual horizon] has been assigned, the camera will display pitch and roll indicators in the viewfinder based on information from its built-in tilt sensor. These indicators can be read as follows:

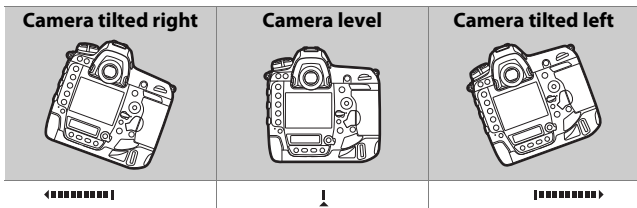
### Roll

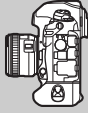

## Pitch

Camera tilted forward	Camera level	Camera tilted back
 ↑	 —	 ↓

- Note that the display may not be accurate when the camera is tilted at a sharp angle forward or back. The camera will not display pitch and roll indicators when held at angles at which tilt cannot be measured.
- The roles of the pitch and roll indicators are reversed when the camera is rotated to take pictures in “tall” (portrait) orientation.

## f4: Multi Selector Center Button



MENU button →  Custom Settings menu

Choose the role assigned to the center of the multi selector during playback and still photography.

## Viewfinder Photography







	Role	Description
RESET	[ <b>Select center focus point</b> ]	Pressing the center of the multi selector selects the center focus point.
PRE <sup>[*]</sup>	[ <b>Preset focus point</b> ]	<p>Pressing the center of the multi selector selects a preset focus point.</p> <ul style="list-style-type: none"><li>• To choose the point, highlight it, hold the center of the multi selector, and press the AF-mode button until the focus point flashes.</li><li>• Separate focus points can be selected for “wide” (landscape) orientation and for each of the two “tall” (portrait) orientations if an option other than <b>[Off]</b> is selected for Custom Setting a5 <b>[Store points by orientation]</b>.</li><li>• The behavior of the center of the multi selector can be chosen by pressing  when <b>[Preset focus point]</b> is highlighted.<ul style="list-style-type: none"><li>- <b>[Press to recall focus point]</b>: Pressing the center of the multi selector recalls the preset focus point.</li><li>- <b>[Hold to recall focus point]</b>: The preset focus point is selected while the center of the multi selector is pressed. Releasing the center of the multi selector restores the previously-selected focus point.</li></ul></li></ul>
[None]		Pressing the center of the multi selector has no effect.

## Live View

Role		Description
RESET	[Select center focus point]	Pressing the center of the multi selector selects the center focus point.
	[Zoom on/off]	Press the center of the multi selector to zoom the display in on the area around the current focus point (the zoom ratio is selected in advance). Press again to return to the previous display. <ul style="list-style-type: none"><li>• To choose the zoom ratio, highlight [Zoom on/off] and press .</li></ul>
[None]		Pressing the center of the multi selector has no effect.

## Playback Mode

Regardless of the option selected, pressing the center of the multi selector when a movie is displayed full frame starts movie playback.

	Role	Description
	[Filtered playback]	Press the center of the multi selector to view only pictures that meet the criteria selected for [Filtered playback criteria] in the playback menu.
	[Thumbnail on/off]	Press the center of the multi selector to toggle between full-frame and 4-, 9-, or 72-frame thumbnail playback.
	[View histograms]	A histogram is displayed while the center of the multi selector is pressed. The histogram display is available in both full-frame and thumbnail playback.
	[Zoom on/off]	Press the center of the multi selector to zoom the display in on the area around the active focus point (the zoom ratio is selected in advance). Press again to return to the previous display. <ul style="list-style-type: none"><li>• To choose the zoom ratio, highlight [Zoom on/off] and press .</li><li>• Zoom is available in both full-frame and thumbnail playback.</li></ul>
	[Choose slot and folder]	Press the center of the multi selector to display the [Choose slot and folder] dialog, where you can then choose a slot and folder for playback.

## f5: Shutter Spd & Aperture Lock

MENU button ➡  Custom Settings menu

Selecting [On] for [Shutter speed lock] locks shutter speed at the value currently selected in mode **S** or **M**. Selecting [On] for [Aperture lock] locks aperture at the value currently selected in mode **A** or **M**.

- Shutter speed and aperture lock are not available in mode **P**.



## f6: Customize Command Dials

MENU button ➡  Custom Settings menu

Customize the operation of the main and sub-command dials.

## Reverse Rotation

Reverse the direction of rotation of the command dials for exposure compensation and shutter speed/aperture selection.

- Highlight [**Exposure compensation**] or [**Shutter speed/aperture**] and press  to select () or deselect ()
- Press  to save changes and exit.
- The changes apply also to the command dials for vertical shooting.

## Change Main/Sub

Reverse the roles of the main- and sub-command dials. The changes apply also to the command dials for vertical shooting.

Option	Description
[ <b>Exposure setting</b> ]	If [ <b>On</b> ] is selected, the main command dial will control aperture and the sub-command dial shutter speed. If [ <b>On (Mode A)</b> ] is selected, the main command dial will be used to set aperture in mode <b>A</b> only.
[ <b>Autofocus setting</b> ]	If [ <b>On</b> ] is selected, AF-area mode can be selected by holding the AF-mode button and rotating the main command dial, autofocus mode by holding the AF-mode button and rotating the sub-command dial.



## Aperture Setting

Choose whether aperture can be adjusted using the aperture ring on CPU lenses in modes **A** and **M**.



Option	Description
[Sub-command dial]	Aperture can only be adjusted with the sub-command dial (or with the main command dial if [On] is selected for [Change main/sub] > [Exposure setting]).
[Aperture ring]	Aperture can be adjusted with the lens aperture ring. The camera aperture display shows aperture in increments of 1 EV, although fractions of 1 EV can still be selected using the aperture ring.

- Regardless of the option selected for [Aperture setting], aperture for lenses not equipped with an aperture ring (type G and E lenses) must be adjusted using the sub-command dial.
- Regardless of the option selected for [Aperture setting], aperture for non-CPU lenses must be adjusted using the lens aperture ring.

## Menus and Playback





Choose the roles played by the multi selector and command dials during playback and menu navigation.

Option	Description
[On]	<p><b>Playback:</b></p> <ul style="list-style-type: none"><li>• The main command dial can be used to choose the picture displayed during full-frame playback. The sub-command dial can be used to skip forward or back according to the option selected for [<b>Sub-dial frame advance</b>].</li><li>• During thumbnail playback, the main command dial can be used to highlight thumbnails and the sub-command dial to page up or down.</li></ul> <p><b>Menus*:</b></p> <p>Use the main command dial to highlight menu items. Rotating the sub-command dial clockwise displays the sub-menu for the highlighted option. Rotating it counter-clockwise displays the previous menu.</p>
ON <sup>⊙</sup> [On (image review excluded)]	As for [On] except that the command dials cannot be used for playback during image review.
[Off]	Use the multi selector to choose the picture displayed during full-frame playback or to highlight pictures or menu items.

\* The sub-command dial cannot be used to select highlighted items. To select highlighted items, press , , or the center of the multi selector.

## Sub-Dial Frame Advance

Choose the number of frames that can be skipped by rotating the sub-command dial during full-frame playback. This option only takes effect when **[On]** or **[On (image review excluded)]** is selected for **[Menus and playback]**.

Option	Description
[10 frames]	Skip forward or back 10 frames at a time.
[50 frames]	Skip forward or back 50 frames at a time.
★ [Rating]	Skip to the next or previous pictures with the selected rating. To choose the rating, highlight [Rating] and press  .
 [Protect]	Skip to the next or previous protected picture.
 [Still images only]	Skip to the next or previous photo.
 [Movies only]	Skip to the next or previous movie.
 [Folder]	Rotate the sub-command dial to switch folders.

## f7: Multi Selector





MENU button ➡  Custom Settings menu

Choose whether using the multi selector reactivates the standby timer.

## f8: Release Button to Use Dial

MENU button ➡  Custom Settings menu



Selecting **[Yes]** allows adjustments that are normally made by holding a button and rotating a command dial to be made by rotating the command dial after the button is released. This ends when the button is pressed again, the shutter-release button is pressed halfway, or the standby timer expires.

- **[Release button to use dial]** applies to the , **ISO** (FORMAT), **MODE**, **BKT**, , , , **QUAL**, **WB**, and AF-mode buttons.
- **[Release button to use dial]** also applies to controls to which the following roles have been assigned using Custom Settings f3 **[Custom controls]**: **[Exposure mode]**, **[Exposure compensation]**, **[AF mode/AF-area mode]**, **[ISO sensitivity]**, **[Active D-Lighting]**, and **[Metering]**.

## f9: Reverse Indicators



MENU button ➡  Custom Settings menu





Choose whether the exposure indicators in the top control panel and information display are shown with negative values on the left and positive values on the right, or with positive values on the left and negative values on the right.

	Option	Description
+0-		The indicator is displayed with positive values on the left and negative values on the right.
-0+		The indicator is displayed with negative values on the left and positive values on the right.

## f10: Live View Button Options

MENU button ➡  Custom Settings menu

The  button can be disabled to prevent live view starting accidentally when the  button is pressed.

Option	Description
[Enable]	Pressing the  button starts live view.
 [Enable (standby timer active)]	Pressing the  button starts live view only when the standby timer is active.
[Disable]	Pressing the  button does not start live view.

## f11: Switch

MENU button ➡  Custom Settings menu

Choose whether rotating the power switch to  activates only the control panel and button backlights or also turns on the information display.

## f12: Full-Frame Playback Flicks

MENU button ➡  Custom Settings menu

Choose the role assigned to the flick up, down, left, or right gestures during full-frame playback.

### Flick Up/Flick Down

Choose the operation performed by flicking up or down.

Option	Description
[Rating]	Assign the current picture a pre-selected rating. The rating can be chosen by pressing  .
[Select to send (wired LAN/WT)]	Mark the current picture for upload to a computer or ftp server to which the camera is connected via Ethernet or using a wireless transmitter.
[Protect]	Protect the current picture.
[Voice memo]	Flick to start recording a voice memo. If a memo already exists for the current picture, flicking instead begins playback of the existing memo. Press the center of the multi selector to end recording or playback.
[None]	Flicking up or down has no effect.

- Pictures selected by flicking up or down when [Rating], [Select to send (wired LAN/WT)], or [Protect] is selected are indicated by icons ( 406). The marking can be removed by flicking again in the same direction.

## Flick Advance Direction

Choose the gesture used for frame advance.

	<b>Option</b>	<b>Description</b>
←	[Left←Right]	Flick from right to left to view the next picture.
→	[Left→Right]	Flick from left to right to view the next picture.















# g: Movie











## g1: Customize Menu

MENU button →  Custom Settings menu



Choose the items listed in the **i** menu displayed when the **i** button is pressed during movie recording. For information on customizing the **i** menu, see “Customizing the **i** Menu: Customize **i** Menu” (📖 377).

	Item	📖
	[Choose image area]	292
	[Frame size and rate/Image quality]	294
	[Destination]	783
	[Exposure compensation]	199
ISO	[ISO sensitivity settings]	786
WB	[White balance]	787
	[Set Picture Control]	788



	Item	📖
	[Active D-Lighting]	788
	[Metering]	178
AF	[Autofocus mode]	151
	[AF-area mode]	160
	[Electronic VR]	791
	[Microphone sensitivity]	792
	[Attenuator]	793
	[Frequency response]	793

Item		📖	Item		📖
	[Wind noise reduction]	794		[Bluetooth connection]	929
	[Headphone volume]	794		[Wi-Fi connection]	932
	[Custom controls]	879		[Wired LAN/WT]	937
	[Peaking highlights]	832		[Multi-selector power aperture]	878
	[Highlight display]	884		[Multi selector exposure comp.]	878
	[Monitor brightness]	889			

## Multi-Selector Power Aperture

Choose whether the multi selector can be used for power aperture. When **[Enable]** is selected, holding  widens the aperture. Holding  narrows the aperture.

## Multi Selector Exposure Comp.

Choose whether the multi selector can be used to adjust exposure compensation. Selecting **[Enable]** allows exposure compensation to be set by pressing  or .

## g2: Custom Controls

MENU button ➔  Custom Settings menu

Choose the functions performed either by pressing camera controls or by pressing controls and rotating command dials during filming.

- Choose the roles played by the controls below. Highlight the desired control and press .



### Option

 [Preview button]

 [Fn1 button]





 [Fn2 button]







 [Fn3 button]





 [Sub-selector center]



 [Shutter-release button]

- The roles that can be assigned are listed below. The roles available vary with the control.

	Role	Description
	[Power aperture (open)]	Aperture widens while the <b>Pv</b> button is pressed. Use in combination with Custom Setting g2 [ <b>Custom controls</b> ] > [ <b>Fn1 button</b> ] > [ <b>Power aperture (close)</b> ] for button-controlled aperture adjustment.
	[Power aperture (close)]	Aperture narrows while the <b>Fn1</b> button is pressed. Use in combination with Custom Setting g2 [ <b>Custom controls</b> ] > [ <b>Preview button</b> ] > [ <b>Power aperture (open)</b> ] for button-controlled aperture adjustment.
	[Exposure compensation +]	Exposure compensation increases while the <b>Pv</b> button is pressed. Use in combination with Custom Setting g2 [ <b>Custom controls</b> ] > [ <b>Fn1 button</b> ] > [ <b>Exposure compensation -</b> ] for button-controlled exposure compensation.
	[Exposure compensation -]	Exposure compensation decreases while the <b>Fn1</b> button is pressed. Use in combination with Custom Setting g2 [ <b>Custom controls</b> ] > [ <b>Preview button</b> ] > [ <b>Exposure compensation +</b> ] for button-controlled exposure compensation.
	[Framing grid display]	Press the control to display a framing grid in the monitor. Press the control again to turn the display off.

Role		Description
	<b>[Zoom on/off]</b>	Press the control to zoom the display in on the area around the current focus point (the zoom ratio is selected in advance). Press again to cancel zoom. To choose the zoom ratio, highlight <b>[Zoom on/off]</b> and press  .
	<b>[MY MENU]</b>	Press the control to display "MY MENU".
	<b>[Access top item in MY MENU]</b>	Press the control to jump to the top item in "MY MENU." Select this option for quick access to a frequently-used menu item.
RESET	<b>[Select center focus point]</b>	Press the control to select the center focus point.
	<b>[AF lock only]</b>	Focus locks while the control is pressed.
	<b>[AE lock (Hold)]</b>	Exposure locks when the control is pressed. Exposure lock does not end when the shutter is released. Exposure remains locked until the control is pressed a second time or the standby timer expires.
	<b>[AE/AWB lock (hold)]</b>	Exposure locks when the control is pressed. If <b>[Auto]</b> or <b>[Natural light auto]</b> is selected for white balance, white balance will lock at the value selected by the camera (white-balance lock). Exposure and white-balance lock do not end when the shutter is released. The lock will however be released when the control is pressed a second time or the standby timer expires.

	Role	Description
	[AE lock only]	Exposure locks while the control is pressed.
	[AE/AF lock]	Focus and exposure lock while the control is pressed.
	[Take photos]	Press the shutter-release button all the way down to take a photograph with an aspect ratio of 16:9.
	[Record movies]	<p>Press the shutter-release button halfway to start live view. If the focus mode selector is in the <b>AF</b> position, you can then press the shutter-release button halfway again to focus. To start movie recording, press the shutter-release button the rest of the way down. Press the shutter-release button again to end recording.</p> <ul style="list-style-type: none"> <li>• When [Record movies] is selected, the shutter-release button cannot be used for any purpose other than recording movies.</li> <li>• To end live view, press the  button.</li> <li>• The shutter-release buttons on optional wireless remote controllers or remote cords function in the same way as the camera shutter-release button.</li> </ul>

	Role	Description
	[Choose image area]	Press the control and rotate a command dial to choose the image area for movies. Note that the image area cannot be changed while recording is in progress.
	[Microphone sensitivity]	Press the control and rotate a command dial to adjust microphone sensitivity.
	[None]	The control has no effect.



### Power Aperture

- Power aperture is available only in modes **A** and **M**.
- A  icon displayed in the monitor indicates that power aperture cannot be used.
- The display may flicker while aperture is adjusted.

### g3: Multi Selector Center Button

MENU button ➡  Custom Settings menu

Choose the role assigned to the center of the multi selector during filming.

Role		Description
RESET	[ <b>Select center focus point</b> ]	Pressing the center of the multi selector selects the center focus point.
	[ <b>Zoom on/off</b> ]	Press the center of the multi selector to zoom the display in on the area around the current focus point (the zoom ratio is selected in advance). Press again to return to the previous display. To choose the zoom ratio, highlight [ <b>Zoom on/off</b> ] and press  .
	[ <b>Record movies</b> ]	Press the center of the multi selector to start recording. Press again to end recording.
[None]		Pressing the center of the multi selector has no effect.

### g4: Highlight Display

MENU button ➡  Custom Settings menu

Choose whether shading is used to indicate highlights (bright areas of the frame) during movie recording.



## Display Pattern

To enable the highlight display for movie recording, select [**Pattern 1**] or [**Pattern 2**].

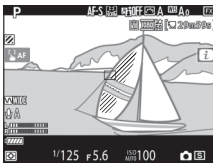

Pattern 1

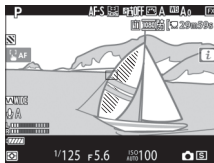

Pattern 2

## Highlight Display Threshold

Choose the brightness needed to trigger the movie highlight display. The lower the value, the greater the range of brightnesses that will be shown as highlights. If [**255**] is selected, the highlight display will show only areas that are potentially overexposed.

---

### **Highlight Display**

If both the highlight display and peaking highlights are enabled, only peaking highlights will be displayed in manual focus mode. To view the highlight display in manual focus mode, select [**Off**] for Custom Setting d10 [**Peaking highlights**] > [**Peaking level**].

---

## 🔑 The Setup Menu: Camera Setup

To view the setup menu, select the 🔑 tab in the camera menus.

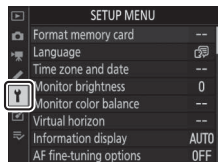

The setup menu contains the following items:

Item	📖	Item	📖
[Format memory card]	887	[Image Dust Off ref photo]	906
[Language]	888	[Pixel mapping]	910
[Time zone and date]	889	[Image comment]	911
[Monitor brightness]	889	[Copyright information]	912
[Monitor color balance]	890	[IPTC]	914
[Virtual horizon]	892	[Voice memo options]	920
[Information display]	893	[Beep options]	923
[AF fine-tuning options]	894	[Touch controls]	924
[Non-CPU lens data]	904	[HDMI]	925
[Clean image sensor]	905	[Location data (built-in)]	925
[Lock mirror up for cleaning] *	906	[Wireless remote (WR) options]	925

Item	📖	Item	📖
[Assign remote (WR) Fn button]	928	[Wired LAN/WT]	937
[Airplane mode]	929	[Conformity marking]	949
[Connect to smart device]	929	[Battery info]	950
[Connect to PC (built-in Wi-Fi)]	932	[Slot empty release lock]	951
		[Save/load menu settings]	952
		[Reset all settings]	957
		[Firmware version]	957

\* Not available at battery levels of  or below.

## Format Memory Card

MENU button ➡  setup menu

Format memory cards. To begin formatting, choose a memory card slot and select [**Yes**]. *Note that formatting permanently deletes all pictures and other data on the card.* Before formatting, be sure to make backup copies as required.









---

### ✓ **During Formatting**

Do not turn the camera off or remove memory cards until the message [**Formatting memory card.**] clears from the display.

---

### ✓ **Two-Button Format**

- Press and hold the  (FORMAT) and **ISO** () buttons simultaneously for over two seconds until **F**  **r** starts to flash in the viewfinder and top control panel; you can then press the two buttons (/FORMAT and **ISO**/) again to format the memory card shown by the flashing indicator in the top control panel.
  - If two memory cards are inserted, the flashing indicator will show the card selected for formatting. To select a different card, rotate the main command dial while the **F**  **r** indicator is flashing.
  - Do not turn the camera off or remove the battery or memory card during formatting.
- 

## Language

MENU button ➡  setup menu

Choose a language for camera menus and messages. The languages available vary with the country or region in which the camera was originally purchased.

## Time Zone and Date

MENU button ➡  setup menu



Change time zones and set the camera clock. We recommend that the camera clock be adjusted regularly.

Option	Description
[Time zone]	Choose a time zone. [Date and time] is automatically set to the time in the new time zone.
[Date and time]	Set the camera clock to the time in the selected [Time zone].
[Date format]	Choose the order in which the day, month, and year are displayed.
[Daylight saving time]	Select [On] to turn daylight saving time on, [Off] to turn it off. Selecting [On] automatically advances the clock one hour. The default setting is [Off].

A flashing  icon in the top control panel indicates that the clock has not been set.

## Monitor Brightness





MENU button ➡  setup menu

Press  or  to adjust monitor brightness. Choose higher values for increased brightness, lower values for reduced brightness.

# Monitor Color Balance

MENU button ➔  setup menu

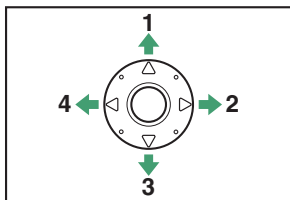
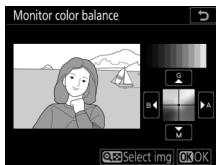

Adjust monitor color balance to your taste.

- Color balance is adjusted using the multi selector. Press , , , or  to adjust color balance as shown below. Press  to save changes.



- 1 Increase green
- 2 Increase amber
- 3 Increase magenta
- 4 Increase blue

- Monitor color balance applies only to menus, playback, and the view through the lens displayed during live view; pictures taken with the camera are not affected.

- The reference image is either the last picture taken or, in playback mode, the picture last displayed. If the memory card contains no pictures, an empty frame will be displayed instead.
- To choose a different picture, press the  button. Highlight the desired picture and press  to select it as the reference image.
- To view the highlighted picture full frame, press and hold .



# Virtual Horizon

MENU button →  setup menu

Display roll and pitch information based on information from the camera tilt sensor.

- If the camera is tilted neither left nor right, the roll reference line will turn green. If the camera is tilted neither forward nor back, the dot (●) in the center of the display will turn green.
- Each division is equivalent to 5°.



Camera level



Camera tilted left or right



Camera tilted forward or back

---

## ✔ The Virtual Horizon Display

Note that the display may not be accurate when the camera is tilted at a sharp angle forward or back. The camera will not display pitch and roll indicators when held at angles at which tilt cannot be measured.

---



# Information Display

MENU button ➔  setup menu

Adjust the appearance of the information display according to lighting conditions.

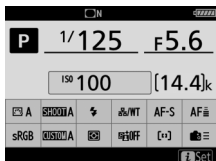

Dark on light



Light on dark

Option	Description
[Auto]	The camera adjusts the color of the lettering in the information display to make it easier to read. Black is used in bright locations, a dim white in dark locations.
[Manual]	Manually choose the color of the lettering. <b>B [Dark on light]:</b> To make the display easier to read in bright locations, the monitor lights and the lettering is displayed in black. <b>W [Light on dark]:</b> To make the display easier to read in dark locations, the monitor dims and the lettering is displayed in white.

# AF Fine-Tuning Options

MENU button ➡  setup menu

Fine-tune focus for the current lens.

- Use only as required.
- We recommend that you perform fine-tuning at a focus distance you use frequently. If you perform fine-tuning at a short focus distance, for example, you may find it less effective at longer distances.

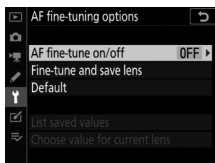

Option	Description
[ <b>AF fine-tune on/off</b> ]	<ul style="list-style-type: none"><li>• [<b>On</b>]: Turn AF fine-tuning on.</li><li>• [<b>Off</b>]: Turn AF fine-tuning off.</li></ul>
[ <b>Fine-tune and save lens</b> ]	<p>Fine-tune focus for the current CPU lens (📷 897).</p> <ul style="list-style-type: none"><li>• The camera can store values for up to 40 lens types.</li><li>• The camera will not save fine-tuning values for non-CPU lenses.</li><li>• New values overwrite existing values.</li></ul>
[ <b>Default</b> ]	<p>Choose the fine-tuning values for lenses for which no values have previously been saved using [<b>Fine-tune and save lens</b>].</p>

Option	Description
<p>[List saved values]</p>	<p>List values saved using [Fine-tune and save lens]. Highlighting a lens in the list and pressing  displays a [Choose lens number] dialog.</p> <ul style="list-style-type: none"> <li>• The [Choose lens number] dialog is used to choose the lens identifier. Choosing a unique identifier—such as the last two digits of the lens serial number—helps you distinguish between multiple lenses of the same type.</li> <li>• With some lenses, the serial number will automatically be entered as the lens identifier.</li> </ul>
<p>[Choose value for current lens]</p>	<p>Choose from multiple fine-tuning values saved for lenses of the same type.</p>

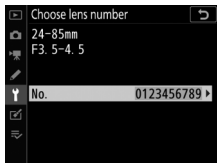

---

### ✔ **Live View Photography**

The fine-tuning value selected using [**AF fine-tuning options**] is not applied to autofocus during live view photography.

### ✔ **Teleconverters**

Separate values can be saved for lenses with teleconverters attached, even if values already exist for the same lenses without teleconverters.

### ✔ **Deleting Saved Values**

To delete values saved using [**Fine-tune and save lens**], highlight the desired lens in the [**List saved values**] list and press  (**FORMAT**).

---

## Creating and Saving Fine-Tuning Values

### 1 Attach the lens to the camera.

### 2 Select [AF fine-tuning options] in the setup menu, then highlight [Fine-tune and save lens] and press .

An AF fine-tuning dialog will be displayed. The options displayed vary with whether the attached lens is a zoom lens or has a fixed focal-length.

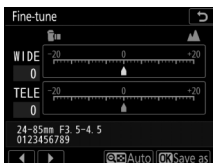

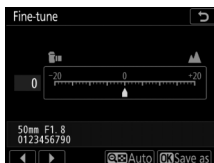

Zoom lens



Fixed focal-length lens

---

### 3 Press or to fine-tune autofocus.

- Choose from values between +20 and -20.
- The current value is shown by ▲, the previously-selected value by △.
- If a zoom lens is attached, you can choose separate fine-tuning values for maximum angle (WIDE) and maximum zoom (TELE). Use  and  to choose between the two.
- The larger the fine-tuning value, the farther the focal point is from the lens; the smaller the value, the closer the focal point.

---

### 4 Press to save the new value.

---

#### Auto AF Fine-Tuning

You can fine-tune autofocus automatically while viewing the results in the live view display (📷 900). Pressing the  button in Step 3 takes you to Step 2 of “Auto AF Fine-Tuning”.

---

## Choosing a Default Fine-Tuning Value

---

**1** Select [AF fine-tuning options] in the setup menu, then highlight [Default] and press .

---

**2** Press  or  to fine-tune autofocus.

- Choose from values between +20 and –20.
  - The current value is shown by ▲, the previously-selected value by Δ.
  - The larger the fine-tuning value, the farther the focal point is from the lens; the smaller the value, the closer the focal point.
- 

**3** Press  to save the new value.

## Auto AF Fine-Tuning

To use auto AF fine-tuning:

- 1 Rotate the live view selector to  and press the  button.**

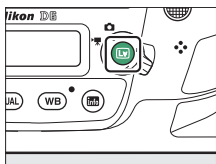

- 2 Press the AF-mode and movie-record buttons simultaneously and keep them pressed for over two seconds.**

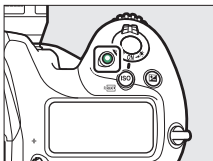
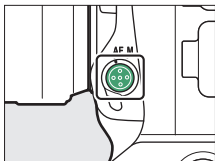



## Zoom Lenses

- The camera will display options for fine-tuning autofocus separately at maximum angle and maximum zoom.

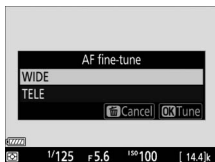

- Highlight **[WIDE]** (maximum angle) or **[TELE]** (maximum zoom) and press **OK**; the camera will select the center focus point and the auto AF fine-tuning dialog will be displayed.

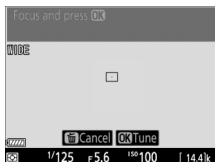

## Fixed Focal-Length Lenses

The camera will select the center focus point and the auto AF fine-tuning dialog will be displayed.

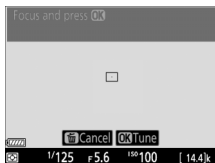

### 3 Press the shutter-release button halfway to focus.

- If you are using a zoom lens, rotate the zoom ring all the way to select either the maximum angle or maximum zoom before focusing.
- Before focusing, mount the camera on a tripod and aim the camera at a flat, high-contrast subject parallel to the camera focal plane.

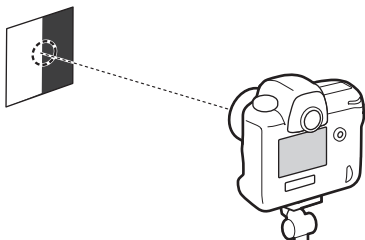
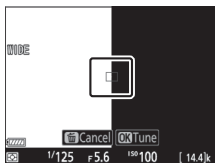

- Auto AF fine-tuning works best at maximum aperture.
- Zoom in on the view through the lens to confirm that the subject is in focus. Focus can be adjusted manually if necessary.
- Note that live view autofocus and auto AF fine-tuning may not function in dark surroundings.

---

## 4 Press **OK**.

- The AF fine-tuning value for the current lens will be added to the **[List saved values]** list (CPU lenses only).
- If auto fine-tuning is successful, **[AF fine-tune on/off]** item will be set to **[On]**, enabling AF fine-tuning.



### Zoom Lenses

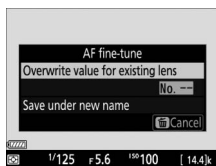

After completing AF fine-tuning for either the maximum angle or maximum zoom, you will need to repeat the process for the remaining item. Press the **Q** button, select **[Overwrite value for existing lens]**, and repeat Steps 2 to 4.



---

## 5 Press **OK** to save changes and exit.

### ✔ If Auto Fine-Tuning Fails

If auto fine-tuning fails, a message will be displayed. Press  to attempt auto fine-tuning again, or press  to exit without performing AF fine-tuning. Pressing  returns you to Step 2.

### ✔ Previously-Saved Lenses

If a fine-tuning value exists for the current lens, you can choose to overwrite the existing value or save the new value separately in Step 2.

## Non-CPU Lens Data

MENU button   setup menu

Record data for non-CPU lenses. Recording the focal length and maximum aperture of non-CPU lenses allows them to be used with some functions normally reserved for CPU lenses.

Option	Description
[Lens number]	Choose a lens identifier.
[Focal length (mm)]	Enter the focal length.
[Maximum aperture]	Enter the maximum aperture.

# Clean Image Sensor

MENU button ➡  setup menu

Dirt or dust entering the camera when lenses are exchanged or the body cap is removed may adhere to the low-pass filter covering the image sensor and affect your photographs. The “clean image sensor” option vibrates the sensor to remove dust.

Option	Description
[Clean now]	Perform image sensor cleaning immediately.
[Clean at startup/ shutdown]	<ul style="list-style-type: none"><li>• [Clean at startup]: The image sensor is automatically cleaned each time the camera is turned on.</li><li>• [Clean at shutdown]: The image sensor is automatically cleaned during shutdown each time the camera is turned off.</li><li>• [Clean at startup &amp; shutdown]: The image sensor is cleaned automatically at startup and at shutdown.</li><li>• [Cleaning off]: Automatic image sensor cleaning off.</li></ul>

## Lock Mirror Up for Cleaning

MENU button ➔  setup menu

Use [**Lock mirror up for cleaning**] to lock the mirror up so that dust that cannot be removed using the “clean image sensor” option can be removed manually. For more information, see “Manual Cleaning” ( 1078).

## Image Dust Off Ref Photo

MENU button ➔  setup menu

Acquire reference data for the Image Dust Off option in Capture NX-D. Image Dust Off processes NEF (RAW) images to mitigate effects caused by dust adhering to the low-pass filter in front of the camera image sensor. For more information, refer to Capture NX-D online help.

# Acquiring Image Dust Off Reference Data

## 1 Choose a start option.

- Highlight [**Start**] and press  $\odot$  to immediately display the [**Image Dust Off ref photo**] dialog.



- Highlight [**Clean sensor and then start**] and press  $\odot$  to clean the image sensor before starting. The [**Image Dust Off ref photo**] dialog will be displayed when image sensor cleaning is complete.

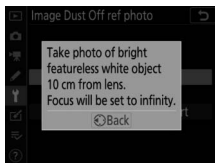

- "rEF" will appear in the viewfinder and control panel displays.



- To exit without acquiring Image Dust Off reference data, press MENU.

---

## 2 With the lens about ten centimeters (four inches) from a well-lit, featureless white object, frame the object so that it fills the display and then press the shutter-release button halfway.

- In autofocus mode, focus will automatically be set to infinity.
- In manual focus mode, set focus to infinity manually.

---

## 3 Press the shutter-release button the rest of the way down to acquire Image Dust Off reference data.

- The monitor turns off when the shutter-release button is pressed.
- If the reference object is too bright or too dark, the camera may be unable to acquire Image Dust Off reference data, in which case a message will be displayed and the camera will return to the display shown in Step 1. Choose another reference object and press the shutter-release button again.





---

## ✔ Image Sensor Cleaning

Dust off reference data recorded before image sensor cleaning is performed cannot be used with photographs taken after image sensor cleaning is performed. Select **[Clean sensor and then start]** only if the Image Dust Off reference data will not be used with existing photographs.

## ✔ Acquiring Image Dust Off Reference Data

- **[Image Dust Off ref photo]** is not available when a non-CPU lens is mounted on the camera.
- An FX-format CPU lens with a focal length of at least 50 mm is recommended; DX-format lenses are not recommended.
- When using a zoom lens, zoom all the way in.
- The same reference data can be used for photographs taken with different lenses or at different apertures.
- Image Dust Off cannot be used with NEF (RAW) images recorded at sizes of **[Medium]** or **[Small]**.
- Reference images cannot be viewed using computer imaging software.
- A grid pattern is displayed when reference images are viewed on the camera.

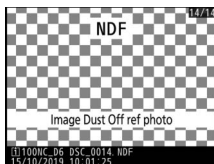

# Pixel Mapping

MENU button ➡  setup menu

Pixel mapping checks and optimizes the camera image sensor. If you notice unexpected bright spots appearing in pictures taken with the camera, perform pixel mapping as described below.

- Use a fully-charged battery to prevent unexpected loss of power.
- Attach the lens cap (front cap) and close the eyepiece shutter before performing pixel mapping.

---

## 1 Select [Pixel mapping] in the setup menu.

Turn the camera on, press the MENU button, and select [Pixel mapping] in the setup menu.

---

## 2 Select [Start].

Pixel mapping will start. “ 53” appears in the top control panel while the operation is in progress.

---

## 3 Turn the camera off when pixel mapping is complete.

---

## ✔ Pixel Mapping



- Do not attempt to operate the camera while pixel mapping is in progress. Do not turn the camera off or remove or disconnect the power source.
  - Pixel mapping may not be available if the camera's internal temperature is elevated.
- 

## Image Comment



MENU button ➡  setup menu

Create a comment that can be appended to subsequent images. Comments can be viewed as metadata in ViewNX-i or Capture NX-D.

## Input Comment

Input a comment up to 36 characters long. Highlight [**Input comment**] and press  to display a text-entry dialog. For information on text entry, see "Text Entry" ( 86).

## Attach Comment

To attach the comment to subsequent photographs, highlight [**Attach comment**], press , and confirm that a check () appears in the adjacent check box. Press  to save changes and exit; the comment will be attached to all subsequent photographs.

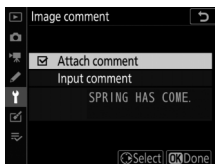

---

### Photo Info

- Comments can be viewed on the [**Other shooting data**] page in the photo information display.
- To display the [**Other shooting data**] page, select () both [**Shooting data**] and [**Other shooting data**] for [**Playback display options**] in the playback menu.

---

## Copyright Information

MENU button  setup menu

Add copyright information to new photographs as they are taken. Copyright information can be viewed as metadata in ViewNX-i or in Capture NX-D.

## Artist/Copyright

Enter a photographer name up to 36 characters long and a copyright holder name up to 54 characters long. Highlight [**Artist**] or [**Copyright**] and press  $\blacktriangleright$  to display a text-entry dialog. For information on text entry, see “Text Entry” (📖 86).

## Attach Copyright Information

To attach copyright information to subsequent photographs, highlight [**Attach copyright information**], press  $\blacktriangleright$ , and confirm that a check () appears in the adjacent check box. Press  $\odot$  to save changes and exit; copyright information will be attached to all subsequent photographs.



---

### Copyright Information

- To prevent unauthorized use of the artist or copyright holder names, disable [**Attach copyright information**] before lending or transferring the camera to another person. You will also need to make sure that the artist and copyright fields are blank.
- Nikon does not accept liability for any damages or disputes arising from the use of the [**Copyright information**] option.

## ✔ Viewing Copyright Information

- Copyright information can be viewed on the [**Copyright info**] page of the camera photo information display.
- To display the [**Copyright info**] page, select (✔) both [**Shooting data**] and [**Copyright info**] for [**Playback display options**] in the playback menu.

## IPTC

MENU button ➔  setup menu



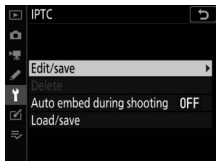

IPTC presets can be created or edited on the camera and embedded in new photographs as described below.

- You can also load IPTC presets created on a computer.
- To create IPTC presets and save them to memory cards for later import, use IPTC Preset Manager (📖 919).



## **Renaming, Editing, and Copying Presets**

Highlight [**Edit/save**] and press  to display the [**Select preset to edit or save**] list of existing presets.

- To edit or rename a preset, highlight it and press . To create a new preset, highlight [**Unused**] and press .
  - [**Rename**]: Rename the preset.
  - [**Edit IPTC information**]: Display the selected preset ( 918). Selected fields can be edited as desired.
- To copy a preset, highlight it and press . Highlight the destination, press , and name the copy.

## **Deleting Presets**

To delete presets, highlight [**Delete**] and press .

## Embedding Presets

Highlighting [**Auto embed during shooting**] and pressing **▶** displays a list of presets. Highlight a preset and press **OK**; the selected preset will be embedded in all subsequent photographs. To disable embedding, select [**Off**].

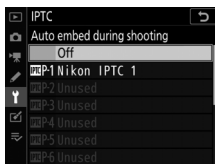

---

### **✓ Viewing IPTC Data**

- Embedded presets can be viewed on the [**IPTC data**] page of the camera photo information display.
- To display the [**IPTC data**] page, select () both [**Shooting data**] and [**IPTC data**] for [**Playback display options**] in the playback menu.

---

## Copying Presets to a Memory Card







To copy IPTC presets from the camera to a memory card, choose [**Load/save**], select [**Slot 1**] or [**Slot 2**], then highlight [**Copy to card**] and press **▶**. Highlight the desired destination (1–99) and press **OK** to copy the preset to the card.

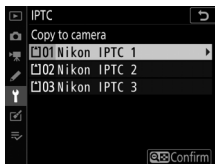

## Copying Presets to the Camera

The camera can store up to ten presets; to copy IPTC presets from a memory card to a selected destination on the camera, choose [**Load/save**], select [**Slot 1**] or [**Slot 2**], then highlight [**Copy to camera**] and press .



- Highlight a preset and press  to proceed to the [**Select destination**] list. To preview the highlighted preset, press  instead of pressing . After previewing the preset, press  to proceed to the [**Select destination**] list.
- Highlight a destination and press  to display a dialog where you can name the preset. Name the preset as desired and press  to copy the preset to the camera.
- In addition to the ten presets mentioned above, the camera can store up to three XMP/IPTC presets created on a computer and saved in XMP format. XMP/IPTC presets are not displayed during playback. Nor can they be copied from the camera to a memory card.

## ✔ IPTC Information

- The camera supports standard roman alphanumeric characters only. Other characters will not display correctly except on a computer.
- Preset names (☐ 915) may be up to 18 characters long. If a preset with a longer name is created using a computer, all characters after the eighteenth will be deleted.
- The number of characters that may appear in each field is given below. Any characters over the limit will be deleted.

Field	Maximum length
Caption	2000
Event ID	64
Headline	256
Object Name	256
City	256
State	256
Country	256
Category	3

Field	Maximum length
Supp. Cat.(Supplemental Categories)	256
Byline	256
Byline Title	256
Writer/Editor	256
Credit	256
Source	256

---

## IPTC

IPTC is a standard established by the International Press Telecommunications Council (IPTC) with the intent of clarifying and simplifying the information required when photographs are shared with a variety of publications.

## IPTC Preset Manager

IPTC presets can be created on a computer and saved to memory cards using IPTC Preset Manager software. IPTC Preset Manager can be downloaded free of charge from the URL below. Instructions on use are available via online help.

<https://downloadcenter.nikonimglib.com/>

## Creating IPTC Presets in a Web Browser

When connected to the camera from a computer or smart device in http server mode (☐ 601), you can use a web browser to edit IPTC presets and embed them in photographs.

---



# Voice Memo Options

MENU button ➔  setup menu

Adjust settings for voice memos ( 436).

## Voice Memo

Choose whether voice memos are recorded manually or automatically after a photograph is taken.

	Option	Description
	[Off]	Voice memos cannot be recorded in shooting mode.
	[On (Auto and manual)]	Voice memos are recorded automatically when shooting ends. <ul style="list-style-type: none"><li>• Selecting [On (Auto and manual)] displays an [Auto] menu where you can select the recording time.</li></ul>
	[Manual only]	Memos can be manually added to the most recent photograph.



## Voice Memo Overwrite

Choose whether the voice memo for the most recent photograph can be overwritten in shooting mode.

Option	Description
[Disable]	Voice memos cannot be recorded in shooting mode if one already exists for most recent photograph.
[Enable]	Each new voice memo overwrites the memo for the most recent photograph, if any.









## Voice Memo Control

Choose how the **Fn3** (🎤) button behaves when used to record voice memos.

Option	Description
 [Press and hold]	Voice memos up to 60 seconds long can be recorded while the <b>Fn3</b> (🎤) button is pressed.
 [Press to start/stop]	Recording begins when the <b>Fn3</b> (🎤) button is pressed and ends after about 60 seconds or when the control is pressed a second time.

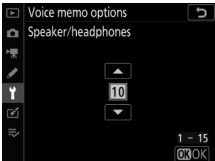
## Audio Output

Choose the device used for voice memo playback.

	Option	Description
	<b>[Speaker/ headphones]</b>	<p>Voice memos are played back over headphones (if connected) or the camera's built-in speaker.</p> <ul style="list-style-type: none"><li>• Press  or  to choose a volume between [1] and [15].</li><li>• Press  to save changes and exit.</li></ul> 
HDMI	<b>[HDMI]</b>	Voice memos are output to the HDMI terminal at a fixed volume.
	<b>[Off]</b>	Voice memos cannot be played even using the <b>Fn3</b> (  ) button.  icons are displayed when photographs for which memos exist are viewed in the monitor.

## Beep On/Off

Turn the beep speaker on or off.

- If [**On**] is selected for [**Beep on/off**], beeps will sound when:
  - the self-timer counts down,
  - the shutter-release button is pressed for a second time during mirror-up photography,
  - interval-timer photography, time-lapse movie recording, or focus shift ends,
  - the camera focuses (note that this does not apply if **AF-C** is selected for autofocus mode or if [**Release**] is selected for Custom Setting a2 [**AF-S priority selection**]), or
  - characters are entered using the on-screen keyboard.
- Select [**Off (touch controls only)**] to disable the beep for touch controls while enabling it for other purposes.
- Note that regardless of the settings selected for [**Beep options**], a beep will not sound when the camera focuses during movie recording, in release mode **Q**, or if [**On**] is selected for [**Silent live view photography**].

## Volume

Adjust beep volume.

## Pitch

Choose the pitch of the beep from [**High**] and [**Low**].

## Touch Controls

MENU button ➔  setup menu

Adjust settings for monitor touch controls.

## Enable/Disable Touch Controls

Enable or disable touch controls. Select [**Playback only**] to enable touch controls in playback mode only.

## Glove Mode

Selecting [**Enabled**] raises the sensitivity of the touch screen, making it easier to use while wearing gloves.



## HDMI

MENU button ➡  setup menu

Adjust settings for connection to HDMI devices (📖 453).

## Location Data (Built-In)

MENU button ➡  setup menu

Adjust settings for use with the camera's built-in GNSS receiver. For more information, see "Location Data" (📖 384).

## Wireless Remote (WR) Options

MENU button ➡  setup menu

Adjust status LED and link mode settings for optional WR-R10 wireless remote controllers. You can also choose a link mode for connection to optional radio-controlled flash units that support Advanced Wireless Lighting.

### **The WR-R10 Wireless Remote Controller**

- A WR-A10 adapter is required when using the WR-R10.
- Be sure the firmware for the WR-R10 has been updated to the latest version (version 3.0 or later). For information on firmware updates, see the Nikon website for your area.





## **LED Lamp**

Enable or disable the status LEDs on a WR-R10 wireless remote controller mounted on the camera. For more information, see the documentation supplied with the wireless remote controller.

## **Link Mode**

Choose a link mode for WR-R10 wireless remote controllers mounted on other cameras or radio-controlled flash units that support Advanced Wireless Lighting. Be sure that the same mode is selected for the other devices.

<b>Option</b>	<b>Description</b>
<b>[Pairing]</b>	<p>The camera connects only to devices with which it has previously been paired. Press the pairing button on the WR-R10 wireless remote controller connected to the camera to pair it with other devices.</p> <ul style="list-style-type: none"><li>• As the camera will not communicate with devices with which it has not been paired, this option can be used to prevent signal interference from other devices in the vicinity.</li><li>• Given that each device must be paired separately, however, PIN is recommended when connecting to a large number of devices.</li></ul>

Option	Description
<p><b>[PIN]</b></p>	<p>Communication is shared among all devices with the same four-digit PIN. You can enter any four-digit PIN of your choice.</p> <ul style="list-style-type: none"> <li>• Press  or  to highlight digits and press  or  to change. Press  to enter and display the selected PIN.</li> <li>• This option is a good choice for photography featuring a large number of remote devices.</li> <li>• If there are multiple cameras present that share the same PIN, the flash units will be under the sole control of the camera that connects first, preventing all other cameras from connecting (the LEDs on the WR-R10 units connected to the affected cameras will blink).</li> </ul>















- Regardless of the option selected for **[Link mode]**, signals from paired wireless remote controllers will always be received by the WR-R10. Users of the WR-1 wireless remote controller will need to select pairing as the WR-1 link mode.

# Assign Remote (WR) Fn Button

MENU button ➔  setup menu

Choose the role played by the **Fn** button on optional wireless remote controllers equipped with an **Fn** button. See Custom Setting f3 [**Custom controls**] for more information.

Option		Option	
	[AF-ON]		[  Disable/ enable]
	[AF lock only]		[Preview]
	[AE lock (Reset on release)]		[+ NEF (RAW)]
	[AE lock only]		[Live view] *
	[AE/AF lock]		[Recall shooting functions]
	[FV lock]		[None]

\* Performs the same function as the camera  button.

## Airplane Mode

MENU button ➡ ⚙️ setup menu

Select **[Enable]** to disable the camera's built-in Bluetooth and Wi-Fi functions.

- The wireless functions of optional peripheral devices connected to the camera can only be disabled by disconnecting the devices.

## Connect to Smart Device

MENU button ➡ ⚙️ setup menu

Connect to smartphones or tablets (smart devices) via Bluetooth or Wi-Fi.

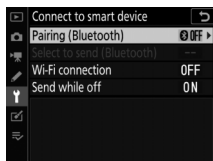

## Pairing (Bluetooth)

Pair with or connect to smart devices using Bluetooth.

Option	Description
[Start pairing]	Pair the camera with a smart device (☑ 469).
[Paired devices]	List paired smart devices. To connect, select a device from the list.
[Bluetooth connection]	Select [Enable] to enable Bluetooth.

## Select to Send (Bluetooth)

Select pictures for upload to a smart device. You can also opt to upload pictures as they are taken.

Option	Description
[Auto select to send]	Select [On] to mark pictures for upload as they are taken. Photos are uploaded in JPEG format at a size of 2 megapixels, even if other upload size and format options are selected with the camera. Photos taken during filming will not be uploaded. They must be uploaded manually.
[Manual select to send]	Upload selected pictures. Transfer marking appears on the selected pictures.
[Deselect all]	Remove transfer marking from all pictures.

## Wi-Fi Connection

Connect to smart devices via Wi-Fi.

### ■ Establish Wi-Fi Connection

Initiate a Wi-Fi connection to a smart device.

- The camera SSID and password will be displayed. To connect, select the camera SSID on the smart device and enter the password (📖 461).
- Once a connection is established, this option will change to **[Close Wi-Fi connection]**.
- Use **[Close Wi-Fi connection]** to end the connection when desired.

### ■ Wi-Fi Connection Settings

Access the following Wi-Fi settings:

Option	Description
<b>[SSID]</b>	Choose the camera SSID.
<b>[Authentication/encryption]</b>	Choose <b>[OPEN]</b> or <b>[WPA2-PSK-AES]</b> .
<b>[Password]</b>	Choose the camera password.
<b>[Channel]</b>	Choose a channel. <ul style="list-style-type: none"><li>• Select <b>[Auto]</b> to have the camera choose the channel automatically.</li><li>• Select <b>[Manual]</b> to choose the channel manually.</li></ul>
<b>[Current settings]</b>	View current Wi-Fi settings.
<b>[Reset connection settings]</b>	Select <b>[Yes]</b> to reset Wi-Fi settings to default values.

## Send While Off

If [**On**] is selected, upload of images to smart devices connected via Bluetooth will continue even when the camera is off.

## Location Data (Smart Device)

Display latitude, longitude, altitude, and UTC (Universal Coordinated Time) data downloaded from a smart device.

## **Connect to PC (Built-in Wi-Fi)**

MENU button → Y setup menu

Connect to computers via Wi-Fi.



## Wi-Fi Connection

Select [**Enable**] to connect using the settings currently selected for [**Network settings**].



## Network Settings

Select [**Create profile**] to create a new network profile (📖 488, 494).

- If more than one profile already exists, you can press Ⓚ to select a profile from a list.
- To edit an existing profile, highlight it and press ⏪.

Option	Description
[General]	<ul style="list-style-type: none"><li>• [<b>Profile name</b>]: Rename the profile. The default profile name is the same as the network SSID.</li><li>• [<b>Password protection</b>]: Select [<b>On</b>] to require that a password be entered before the profile can be changed. To change the password, highlight [<b>On</b>] and press ⏪.</li></ul>

Option	Description
[Wireless]	<ul style="list-style-type: none"> <li>• <b>Infrastructure mode:</b> Adjust settings for connection to a network via a router. <ul style="list-style-type: none"> <li>- [SSID]: Enter the network SSID.</li> <li>- [Channel]: Selected automatically.</li> <li>- [Authentication/encryption]: Choose [OPEN] or [WPA2-PSK-AES].</li> <li>- [Password]: Enter the network password.</li> </ul> </li> <li>• <b>Access-point mode:</b> Adjust settings for direct wireless connection to the camera. <ul style="list-style-type: none"> <li>- [SSID]: Choose the camera SSID.</li> <li>- [Channel]: Choose [Auto] or [Manual].</li> <li>- [Authentication/encryption]: Choose [OPEN] or [WPA2-PSK-AES].</li> <li>- [Password]: If [WPA2-PSK-AES] is selected for [Authentication/encryption], you can choose the camera password.</li> </ul> </li> </ul>
[TCP/IP]	<p>Adjust TCP/IP settings for infrastructure connections. An IP address is required.</p> <ul style="list-style-type: none"> <li>• If [Enable] is selected for [Obtain automatically], the IP address and sub-net mask for infrastructure mode connections will be acquired via a DHCP server or automatic IP addressing.</li> <li>• Select [Disable] to enter the IP address ([Address]) and sub-net mask ([Mask]) manually.</li> </ul>

## **Options**

Adjust upload settings.

### **■ Auto Send**

Select [**On**] to upload new photos as they are taken.

- Upload begins only after the photo has been recorded to the memory card. Be sure a memory card is inserted in the camera.
- Movies and photos taken during filming are not uploaded automatically when recording is complete. They must instead be uploaded from the playback display (☐ 504).

### **■ Delete After Send**

Select [**Yes**] to delete photographs from the camera memory card automatically once upload is complete.

- Files marked for transfer before you selected [**Yes**] are not deleted.
- Deletion may be suspended during some camera operations.

## ■ ■ Send File As

When uploading NEF + JPEG images, choose whether to upload both the NEF (RAW) and JPEG files or only the JPEG copy.

- When [**RAW Slot 1 - JPEG Slot 2**] is selected for [**Role played by card in Slot 2**] in the photo shooting menu, the option chosen for [**Send file as**] applies only to photos uploaded automatically by selecting [**On**] for [**Auto send**].

## ■ ■ JPEG + JPEG Slot Selection

Choose a source slot for auto upload when taking pictures with [**JPEG Slot 1 - JPEG Slot 2**] selected for [**Role played by card in Slot 2**] in the photo shooting menu.

## ■ ■ Deselect All?

Select [**Yes**] to remove transfer marking from all images. Upload of images with a “sending” icon will immediately be terminated.

## MAC Address

View the MAC address.

## Wired LAN/WT

MENU button ➡  setup menu

Adjust settings for upload to a computer or ftp server connected via an Ethernet cable or optional WT-6 wireless transmitter.

### **Wired LAN/WT Functions**

Select [**Enable**] to enable connection via Ethernet or a wireless transmitter. The camera's built-in Bluetooth and Wi-Fi turn off.

### **Choose Hardware**

Choose the connection type: Ethernet ("wired LAN") or wireless LAN.

## Network Settings

Display the network profiles list, where you can create new profiles or select an existing profile.

- Highlight a profile and press **OK** to connect to the highlighted host computer or ftp server.
- The camera can store up to nine network profiles.
- To delete the highlighted profile, press **FORMAT**.
- To view information on the highlighted profile, press **Key** (**INFO**/?).

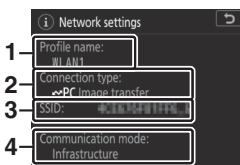

- |   |                                  |
|---|----------------------------------|
| 1 | Profile name                     |
| 2 | Connection type                  |
| 3 | SSID (wireless connections only) |
| 4 | Communication mode               |

- To edit the highlighted profile (**BOOK** 940), press **EDIT** (**EDIT**).

## ■ Synchronized Release

When a WT-6 wireless transmitter is connected, the shutters on remote cameras can be synchronized with the release on a master camera. For more information, see “Synchronized Release” (**BOOK** 628).

## ■ ■ Synchronize Date and Time

Synchronize the clocks on two cameras connected via Ethernet. For more information, see “Synchronizing Camera Clocks” (📖 633).

## ■ ■ Create Profile

Create new network profiles. For more information, see “Creating a Network Profile (Ethernet)” (📖 522) and “Creating Network Profiles (WT-6)” (📖 544).

Option	Description
[ <b>Connection wizard</b> ]	Create a new profile with the help of a wizard.
[ <b>Configure manually</b> ]	Enter [ <b>FTP upload</b> ] or [ <b>HTTP server</b> ] settings manually.

## ■ Copy to/from Card

Use this option to share [FTP upload] and [HTTP server] profiles.

- If there are two memory cards inserted in the camera, the card in the Slot 1 will be used for both “copy from” and “copy to” operations.

Option	Description
[Copy profile from card]	Copy profiles from the root directory of the memory card to the camera profile list.
[Copy profile to card]	Copy profiles from the camera to the memory card. Highlight a profile and press <b>OK</b> to copy it to the memory card. • Password-protected profiles cannot be copied.

## ■ Edit

Edit wireless, TCP/IP, ftp, and other settings for existing profiles. Highlight a profile in the profile list and press **QWERTY** (⚡) to display [Edit] options.

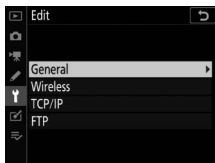



## ✓ Editing Profiles

If the shutter-release button is pressed while menus are displayed, the monitor will turn off. Any changes to the current profile will be lost.

### ● [General]





Edit the profile name and enable or disable password protection.

Option	Description
[Profile name]	Edit the profile name.
[Password protection]	Enable password protection to prevent others from viewing network settings.

### ● [Wireless]

Edit the following wireless settings:

Option	Description
[SSID]	Enter the name (SSID) of the network on which the host computer or ftp server is located. This is a required field.
[Communication mode]	Choose an option according to the type of network. <ul style="list-style-type: none"><li>• [Infrastructure]: Connect via a wireless LAN access point.</li><li>• [Access point]: Connect directly to a computer or ftp server using the camera as a wireless network access point.</li></ul>

Option	Description
[Channel]	Choose a channel ([ <b>Access point</b> ] mode only). If [ <b>Infrastructure</b> ] is selected, the channel will be chosen automatically.
[Authentication]	Choose from [ <b>OPEN</b> ] (open system), [ <b>Shared</b> ] (shared key), [ <b>WPA-PSK</b> ], and [ <b>WPA2-PSK</b> ]. [ <b>Shared</b> ] and [ <b>WPA-PSK</b> ] are available only when [ <b>Infrastructure</b> ] is selected for [ <b>Communication mode</b> ].
[Encryption]	<p>Choose the type of encryption used on the network. If the network uses encryption, enter an encryption key; the number and type of characters in the key vary with the type of encryption selected.</p> <ul style="list-style-type: none"> <li>• [<b>No encryption</b>]: An encryption key is not required.</li> <li>• [<b>WEP: 64-bit, base 16</b>]/[<b>WEP: 128-bit, base 16</b>]: Enter a key of 10 (64-bit) or 26 (128-bit) hexadecimal digits. Press  or  to highlight digits and press  or  to change.</li> <li>• [<b>WEP: 64-bit, ASCII</b>]/[<b>WEP: 128-bit, ASCII</b>]: Enter a key of 5 (64-bit) or 13 (128-bit) alphanumeric characters.</li> <li>• [<b>TKIP</b>]/[<b>AES</b>]: Enter a key of 8 to 63 alphanumeric characters (ASCII). Hexadecimal keys must be 64 hexadecimal digits long.</li> </ul>

Option	Description
[Key index]	If <b>[Infrastructure]</b> is selected for <b>[Communication mode]</b> and <b>[WEP: 64-bit, base 16]</b> , <b>[WEP: 64-bit, ASCII]</b> , <b>[WEP: 128-bit, base 16]</b> , or <b>[WEP: 128-bit, ASCII]</b> is selected for <b>[Encryption]</b> , choose a key index matching that used by the access point or host computer.

## Encryption

The choices available for **[Encryption]** depend on the option chosen for **[Authentication]**:

Authentication	Encryption
[Open]	<p><b>[No encryption]</b>, <b>[WEP: 64-bit, base 16]</b>, <b>[WEP: 64-bit, ASCII]</b>, <b>[WEP: 128-bit, base 16]</b>, <b>[WEP: 128-bit, ASCII]</b></p> <ul style="list-style-type: none"> <li>The only option available when <b>[Access point]</b> is selected for <b>[Communication mode]</b> is <b>[No encryption]</b>.</li> </ul>
[Shared]	<b>[WEP: 64-bit, base 16]</b> , <b>[WEP: 64-bit, ASCII]</b> , <b>[WEP: 128-bit, base 16]</b> , <b>[WEP: 128-bit, ASCII]</b>
[WPA-PSK]	<b>[TKIP]</b> , <b>[AES]</b>
[WPA2-PSK]	<b>[AES]</b>

## ● [TCP/IP]

Enter TCP/IP information.

Option	Description
[ <b>Obtain automatically</b> ]	Choose whether the camera obtains the IP address and sub-net mask automatically or via manual entry. A TCP/IP address is required in either case. <ul style="list-style-type: none"><li>• Select [<b>Enable</b>] to use an IP address and sub-net mask supplied by a DHCP server or automatic private IP addressing.</li><li>• Select [<b>Disable</b>] to enter the IP address ([<b>Address</b>]) and sub-net mask ([<b>Mask</b>]) manually.</li></ul>
[ <b>Gateway</b> ]	If the network requires a gateway address, enter the address supplied by the network administrator.
[ <b>Domain Name Server (DNS)</b> ]	If a Domain Name Server exists on the network, enter the address supplied by the network administrator.

## ● [FTP]

Enter information for connection to an ftp server.

Option	Description
[Server type]	Choose the ftp server type and enter the URL or IP address, destination folder, and port number. An IP address is required.
[PASV mode]	Select [Enable] to enable PASV mode.
[Anonymous login]	Select [Enable] for anonymous login. This option can only be used with servers that are configured for anonymous login. Select [Disable] to supply a user ID and password.
[Proxy server]	Enable this option as required.

## Options

Adjust upload settings. The settings available vary with the connection type.

### ■ Auto Send

Select [On] to upload new photos as they are taken.

- Upload begins only after the photo has been recorded to the memory card. Be sure a memory card is inserted in the camera.
- Movies and photos taken during filming are not uploaded automatically when recording is complete. They must instead be uploaded from the playback display.

## ■ Delete After Send

Select [**Yes**] to delete photographs from the camera memory card automatically once upload is complete.

- Sequential file numbering is used when [**Yes**] is selected, regardless of the item selected for Custom Setting d9 [**File number sequence**].
- Files marked for transfer before you selected [**Yes**] are not deleted.
- Deletion may be suspended during some camera operations.

## ■ Send File As

When uploading NEF + JPEG images, choose whether to upload both the NEF (RAW) and JPEG files or only the JPEG copy.

- When [**RAW Slot 1 - JPEG Slot 2**] is selected for [**Role played by card in Slot 2**] in the photo shooting menu, the option chosen for [**Send file as**] applies only to photos uploaded automatically by selecting [**On**] for [**Auto send**].

## ■ ■ JPEG + JPEG Slot Selection

Choose a source slot for auto upload when taking pictures with [JPEG Slot 1 - JPEG Slot 2] selected for [Role played by card in Slot 2] in the photo shooting menu.

## ■ ■ Overwrite If Same Name

Choose [Yes] to overwrite files with duplicate names during upload. Choose [No] to add numbers to the names of newly uploaded files as necessary to prevent existing files being overwritten.

## ■ ■ Protect If Marked to Send

Select [Yes] to automatically protect files marked for upload. Protection is removed as the files are uploaded.

## ■ ■ Send Marking

Select [On] to add a timestamp to the pictures on the camera memory card giving the time of upload.

The timestamp can be viewed using ViewNX-i or Capture NX-D. For more information, see online help for the software in question or the Capture NX-D manual.

## ■ Send Folder

Select folders for upload. All photos in the selected folders (including those already marked as “sent”) will be marked for upload.

Movies cannot be uploaded using this option. They must instead be uploaded from the playback display.

## ■ Deselect All?

Remove transfer marking from all pictures. Upload of images with a “sending” icon will immediately be terminated.

## ■ HTTP User Settings

Enter a user name and password for connection to an http server (http server connections only).

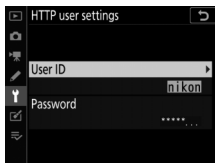



## ■ Power Saving

Choose whether the camera prioritizes network speed or reduced power consumption.

- **[Prioritize network speed]** ensures that LAN connections remain active even when data are not being exchanged with the server. Ethernet connections can use the high-speed 1000BASE-T standard.
- **[Prioritize power saving]** limits Ethernet connections to 100BASE-TX. LAN connections are terminated automatically when data transfer ends. The camera network indicator will turn off.

## ■ MAC Address

When **[Enable]** is selected for **[Wired LAN/WT functions]**, this option can be used to view the MAC address of the hardware selected for **[Choose hardware]**.

## Conformity Marking

MENU button ➡  setup menu

View some of the standards with which the camera complies.

# Battery Info

MENU button ➔  setup menu

View information on the battery currently inserted in the camera.

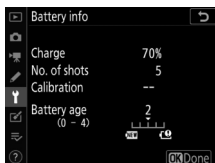

Option	Description
[Charge]	The current battery level, expressed as a percentage.
[No. of shots]	The number of times the shutter has been released since the battery was last charged.
[Calibration]	An indicator of whether the battery requires calibration. Calibration ensures the accuracy of the battery level display; after the battery has been charged a certain number of times, [CAL] will be displayed. <ul style="list-style-type: none"><li>• We recommend that you calibrate the battery when [CAL] is displayed ( 1114).</li><li>• [—]: Calibration not required.</li></ul>
[Battery age]	A five-level display showing battery age. <ul style="list-style-type: none"><li>• A value of "0" (NEW) indicates that battery performance is unimpaired.</li><li>• A value of "4" ( ) indicates that the battery has reached the end of its charging life. Replace the battery.</li></ul>

## ✔ Number of Shots

[**No. of shots**] shows the number of times the shutter has been released. Note that the camera may sometimes release the shutter without recording a photograph, for example when measuring preset white balance.

## ✔ Charging Batteries at Low Temperatures

Batteries in general exhibit a drop in capacity at low ambient temperatures. Even fresh batteries charged at temperatures under about 5 °C (41 °F) may show a temporary increase from “0” to “1” in the value shown for [**Battery age**], but the display will return to normal once the battery has been recharged at a temperature of about 20 °C (68 °F) or higher.

## Slot Empty Release Lock

MENU button ➡  setup menu

Choose whether the shutter can be released when no memory card is inserted in the camera.

	Option	Description
LOCK	[ <b>Release locked</b> ]	The shutter cannot be released when no memory card is inserted.
OK	[ <b>Enable release</b> ]	The shutter can be released with no memory card inserted. No pictures will be recorded; during playback, the camera displays [ <b>Demo</b> ].

# Save/Load Menu Settings

MENU button ➡  setup menu

Save current camera menu settings to a memory card. You can also load saved settings, allowing menu settings to be shared among cameras of the same model.

- If two memory cards are inserted, the settings will be saved to the card in Slot 1.
- The following settings are saved:

## Settings that can be saved and loaded

<b>PLAYBACK MENU</b>	[Playback display options]
	[Image review]
	[After delete]
	[After burst, show]
	[Rotate tall]

## Settings that can be saved and loaded

### PHOTO SHOOTING MENU

[Photo shooting menu bank]

[Extended photo menu banks]

[File naming]

[Role played by card in Slot 2]

[Image area]

[Image quality]

[Image size]

[NEF (RAW) recording]

[ISO sensitivity settings]

[White balance]

[Set Picture Control] (Custom Picture Controls are saved as [Auto])

[Color space]

[Active D-Lighting]

[Long exposure NR]

[High ISO NR]

[Vignette control]

[Diffraction compensation]

[Auto distortion control]

[Flicker reduction]

[Flash control]

[Auto bracketing]

[Silent live view photography]

## Settings that can be saved and loaded

### MOVIE SHOOTING MENU

[File naming]

[Destination]

[Image area]

[Frame size/frame rate]

[Movie quality]

[Movie file type]

[ISO sensitivity settings]

[White balance]

[Set Picture Control] (Custom Picture Controls are saved as [Auto])

[Active D-Lighting]

[High ISO NR]

[Diffraction compensation]

[Flicker reduction]

[Electronic VR]

[Microphone sensitivity]

[Attenuator]

[Frequency response]

[Wind noise reduction]

[Headphone volume]

[Timecode] (excepting [Timecode origin])

## Settings that can be saved and loaded

### CUSTOM SETTING MENU

All items

[Language]

[Time zone and date] (excepting [Date and time])

[Information display]

[Non-CPU lens data]

[Clean image sensor]

[Image comment]

[Copyright information]

[IPTC]

### SETUP MENU

[Voice memo options]

[Beep options]

[Touch controls]

[HDMI]

[Location data (built-in)] ([Standby timer] and [Set clock from satellite] only)

[Wireless remote (WR) options]

[Assign remote (WR) Fn button]

[Slot empty release lock]

## Save Menu Settings

Save settings to a memory card. If the card is full, an error will be displayed and settings will not be saved. Saved settings can only be used with other cameras of the same model.

## Load Menu Settings

Load saved settings from a memory card. Note that [**Load menu settings**] is available only when a memory card containing saved settings is inserted.

---

### **✓ Saved Settings**

Settings are saved to files named "NCSET\*\*\*\*". "\*\*\*\*" is an identifier that varies from camera to camera. The camera will not be able to load settings if the file name is changed.

---



## Reset All Settings

MENU button ➡  setup menu

Reset all settings except [**Language**] and [**Time zone and date**] to their default values. Copyright information and other user-generated entries are also reset. Once reset, settings cannot be restored.

We recommend that you save settings using the [**Save/load menu settings**] item in the setup menu before performing a reset.

## Firmware Version

MENU button ➡  setup menu

View the current camera firmware version.





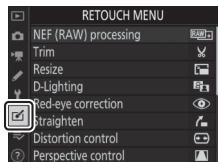







## The Retouch Menu: Creating Retouched Copies

To view the retouch menu, select the  tab in the camera menus.



The items in the retouch menu are used to trim or retouch existing pictures.

- The retouch menu is only displayed when a memory card containing pictures is inserted in the camera.
- Retouched copies are saved to new files, separate from the original pictures.
- The retouch menu contains the following items:

Item			Item		
	[NEF (RAW) processing]	962		[Straighten]	975
	[Trim]	967		[Distortion control]	976
	[Resize]	968		[Perspective control]	978
	[D-Lighting]	973		[Monochrome]	979
	[Red-eye correction]	974		[Image overlay] *	980
				[Trim movie]	989

\* Can only be displayed by pressing **MENU** and selecting the  tab.

# Creating Retouched Copies

## 1 Select an item in the retouch menu.

Press  $\odot$  or  $\ominus$  to highlight an item,  $\odot$  to select.

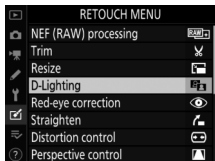

## 2 Select a picture.

- Highlight a picture using the multi selector.
- To view the highlighted picture full screen, press and hold the  $\odot$  button.
- To view pictures in other locations, press  $\odot$  (⚡) and choose the desired card and folder in the [Choose slot and folder] dialog.
- Press  $\odot$  to select the highlighted picture.



---

### 3 Select retouch options.

- For more information, see the section for the selected item.
- To exit without creating a retouched copy, press **MENU**. The retouch menu will be displayed.

---

### 4 Create a retouched copy.

- Press **OK** to create a retouched copy.
- Retouched copies are indicated by a  icon.

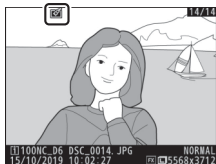

---

#### Retouching the Current Picture

To create a retouched copy of the current picture, press **i** and select **[Retouch]**, or hold **OK** and press **▶**.

#### Retouch

- The camera may not be able to display or retouch pictures that were taken or retouched using other cameras or that have been retouched on a computer.
- If no actions are performed for a brief period, the display will turn off and any unsaved changes will be lost. To increase the time the display remains on, choose a longer menu display time using Custom Setting **c4 [Monitor off delay] > [Menus]**.

### ✔ Retouching Copies

- Most items can be applied to copies created using other retouch options, although multiple edits may result in reduced image quality or faded colors.
- With the exception of [**Trim movie**], each item can be applied only once.
- Some items may be unavailable depending on the items used to create the copy.
- Items that cannot be applied to the current picture are grayed out and unavailable.

### ✔ Image Quality

- Copies created from NEF (RAW) pictures are saved at an [**Image quality**] of [**JPEG fine ★**].
- Copies created from JPEG pictures are the same quality as the original.
- In the case of dual-format pictures recorded to the same memory card at image-quality settings of NEF + JPEG, only the NEF (RAW) copy will be retouched.

### ✔ Image Size

Except in the case of copies created with [**Trim**] and [**Resize**], copies are the same size as the original.

---

# NEF (RAW) Processing: Converting NEF (RAW) to JPEG

MENU button ➡  retouch menu



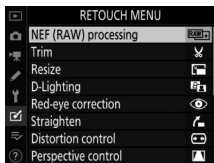

“NEF (RAW) processing” is used to save NEF (RAW) pictures in other formats, such as JPEG. JPEG copies of NEF (RAW) pictures can be created on the camera as described below.

## 1 Select [NEF (RAW) processing] in the retouch menu.

Highlight [NEF (RAW) processing] and press .



## 2 Choose a destination.

- If two memory cards are inserted, highlight [**Choose destination**] and press .
- [**Choose destination**] is not available when only one memory card is inserted. Proceed to Step 3.
- Press  or  to highlight a card slot and press .

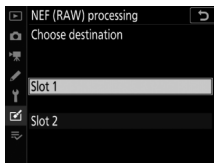
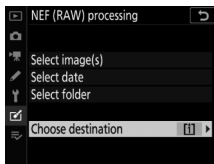

### 3 Choose how pictures are selected.

Option	Description
[ <b>Select image(s)</b> ]	Create JPEG copies of selected NEF (RAW) pictures. Multiple NEF (RAW) pictures can be selected.
[ <b>Select date</b> ]	Create JPEG copies of all NEF (RAW) pictures taken on selected dates.
[ <b>Select folder</b> ]	Create JPEG copies of all NEF (RAW) pictures in a selected folder.

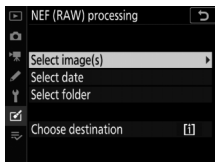

If you chose [**Select image(s)**], proceed to Step 5.

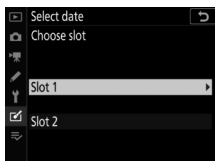

### 4 Select the source slot.

- Highlight the slot with the card containing the NEF (RAW) pictures and press .
- You will not be prompted to select the slot if only one memory card is inserted.





## 5 Select photographs.

### If you chose [Select image(s)]:

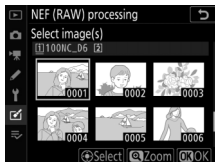
- Highlight pictures using the multi selector.
- To view the highlighted picture full screen, press and hold the  button.
- To select the highlighted picture, press the center of the multi selector. Selected pictures are indicated by a ✓ icon. To deselect the current picture, press the center of the multi selector again; the ✓ will no longer be displayed. All pictures will be processed using the same settings.
- Press  to proceed once selection is complete.



### If you chose [Select date]:

- Highlight dates using the multi selector and press  to select () or deselect () .
- All pictures taken on dates marked with a check () will be processed using the same settings.
- Press  to proceed once selection is complete.

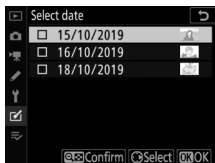



## If you chose [Select folder]:

Highlight a folder and press **OK** to select; all pictures in the selected folder will be processed using the same settings.

## 6 Choose settings for the JPEG copies.

- The settings in effect when the photograph was taken appear below a preview.
- To use the setting in effect when the photograph was taken, if applicable, select [**Original**].

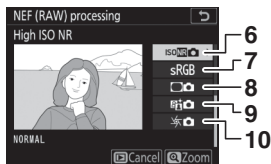
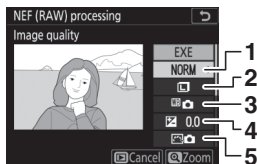

- |   |                               |
|---|-------------------------------|
| 1 | Image quality (📖 142)         |
| 2 | Image size (📖 145)            |
| 3 | White balance (📖 221)         |
| 4 | Exposure compensation (📖 199) |
| 5 | Set Picture Control (📖 271)   |

- |    |                                  |
|----|----------------------------------|
| 6  | High ISO NR (📖 768)              |
| 7  | Color space (📖 765)              |
| 8  | Vignette control (📖 769)         |
| 9  | Active D-Lighting (📖 281)        |
| 10 | Diffraction compensation (📖 770) |

## 7 Copy the photographs.

- Highlight **[EXE]** and press **OK** to create JPEG copies of the selected photographs.
- If multiple photos are selected, a confirmation dialog will be displayed after you highlight **[EXE]** and press **OK**; highlight **[Yes]** and press **OK** to create JPEG copies of the selected photos.
- To exit without copying the photographs, press the **MENU** button.



---



### ✓ NEF (RAW) Processing

- NEF (RAW) processing is available only with NEF (RAW) pictures created with this camera. Pictures in other formats and NEF (RAW) photos taken with other cameras or Camera Control Pro 2 cannot be selected.
  - **[Exposure compensation]** can only be set to values between  $-2$  and  $+2$  EV.
-

# Trim

MENU button ➡  retouch menu

Create a cropped copy of the selected photograph. The photograph is displayed with the selected crop shown in yellow; create a cropped copy as described below.

To	Description
<b>Size the crop</b>	Press  or  to choose the crop size.
<b>Change the crop aspect ratio</b>	Rotate the main command dial to choose the aspect ratio.
<b>Position the crop</b>	Use the multi selector to position the crop.
<b>Save the crop</b>	Press  to save the current crop as a separate file.

## Cropped Pictures

- Depending on the size of the cropped copy, playback zoom may not be available when cropped copies are displayed.
- The crop size appears at upper left in the crop display. The size of the copy varies with crop size and aspect ratio.



# Resize

MENU button ➡  retouch menu

Create small copies of selected photographs. If two memory cards are inserted, you can choose the card used to store the resized copies.

## Resizing Multiple Pictures

If you accessed the retouch menu via the MENU button, you can resize multiple selected pictures.

### 1 Select [Resize] in the retouch menu.

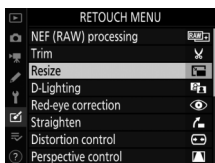

Highlight [Resize] and press .



### 2 Choose a destination.

- If two memory cards are inserted, highlight [**Choose destination**] and press .
- [**Choose destination**] is not available when only one memory card is inserted. Proceed to Step 3.





- Press  or  to highlight a card slot and press .



### 3 Choose a size.

- Highlight [**Choose size**] and press .



- Highlight the desired size (length in pixels) using  and  and press .

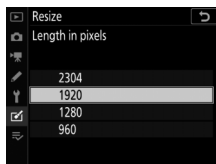

## 4 Choose how pictures are selected.

Option	Description
[ <b>Select image(s)</b> ]	Resize selected pictures. Multiple pictures can be selected.
[ <b>Select date</b> ]	Resize all pictures taken on selected dates.
[ <b>Select folder</b> ]	Resize all pictures in a selected folder.



If you chose [**Select image(s)**], proceed to Step 6.



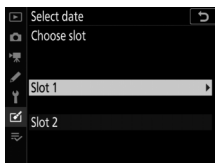

## 5 Select the source slot.

- Highlight the slot with the card containing the desired pictures and press .
- You will not be prompted to select the slot if only one memory card is inserted.





## 6 Select pictures.

### If you chose [Select image(s)]:

- Highlight pictures using the multi selector.
- To view the highlighted picture full screen, press and hold the  button.
- To select the highlighted picture, press the center of the multi selector. Selected pictures are indicated by a  icon. To deselect the current picture, press the center of the multi selector again; the  will no longer be displayed. The selected pictures will all be copied at the size selected in Step 3.
- Press  to proceed once selection is complete.



### If you chose [Select date]:

- Highlight dates using the multi selector and press  to select () or deselect () .
- All pictures taken on dates marked with a check () will be copied at the size selected in Step 3.
- Press  to proceed once selection is complete.

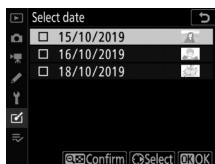

### If you chose [Select folder]:

- Highlight a folder and press **OK** to select; all pictures in the selected folder will be copied at the size selected in Step 3.

## 7 Save the resized copies.

A confirmation dialog will be displayed; highlight [Yes] and press **OK** to save the resized copies.



### ✓ **Resize**

Depending on the copy size, playback zoom may not be available when resized copies are displayed.



# D-Lighting

MENU button ➡  retouch menu

D-Lighting brightens shadows. It is ideal for dark or backlit photographs.

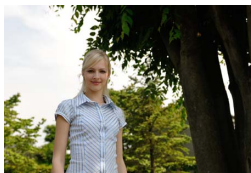

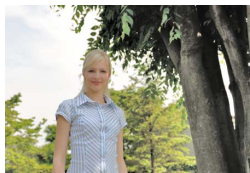

Before



After

The edit display shows before and after images.

- Press  or  to choose the amount of correction performed. The effect can be previewed in the edit display.
- Press  to save the retouched copy.



# Red-Eye Correction

MENU button ➡  retouch menu

Correct “red-eye” caused by light from the flash reflecting from the retinas of portrait subjects.

- Red-eye correction is available only with photographs taken using a flash.
- Red-eye that cannot be detected by the camera will not be corrected.
- Press  to save the retouched copy.

---



## Red-Eye Correction

- Note the following:
    - Red-eye correction may not always produce the expected results.
    - In very rare circumstances, red-eye correction may be applied to portions of the picture that are not affected by red-eye.
  - Check the preview thoroughly before proceeding.
-

# Straighten

MENU button ➡  retouch menu

Rotate pictures by up to  $\pm 5^\circ$  in increments of approximately  $0.25^\circ$ .

- The effect can be previewed in the edit display.
- The greater the rotation, the more will be trimmed from the edges.
- Press  or  to choose the amount of straightening performed.
- Press  to save the retouched copy.

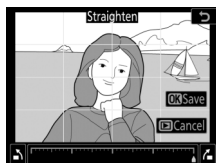



# Distortion Control

MENU button ➡  retouch menu

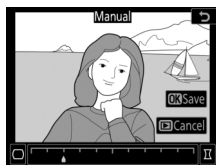
Create copies with reduced peripheral distortion, reducing barrel distortion in pictures taken with wide-angle lenses or pin-cushion distortion in pictures taken with telephoto lenses. Select [**Auto**] to apply automatic distortion control



before making fine adjustments with the multi selector. Select [**Manual**] to reduce distortion manually.

- The effect can be previewed in the edit display.
- [**Auto**] is for use only with pictures taken with type G, E, and D lenses. Note, however, that automatic distortion control is not supported with some lenses of these types, including PC and fisheyes lenses. Results are not guaranteed with other lenses.
- Note that [**Manual**] must be used with copies created using the [**Auto**] option and with photos taken using the [**Auto distortion control**] option in the photo shooting menu. Manual distortion control cannot be further applied to copies created using [**Manual**].
- Press  to reduce pincushion distortion,  to reduce barrel distortion.
- Press  to save the retouched copy.

---

### ✓ **Distortion Control**

- Note that greater amounts of distortion control result in more of the edges being cropped out.
  - Distortion control may heavily crop or distort the edges of copies created from photographs taken with DX lenses at image areas other than [**DX (24×16)**].
-

# Perspective Control

MENU button ➔  retouch menu

Create copies that reduce the effects of perspective in photos taken looking up from the base of a tall object.

- The effect can be previewed in the edit display.
- Note that greater amounts of perspective control result in more of the edges being cropped out.
- Use the multi selector (⬆️, ⬇️, ⬅️, or ⬇️) to adjust perspective.
- Press **OK** to save the retouched copy.

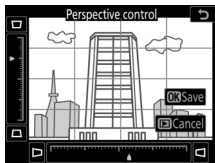

Before





After

# Monochrome

MENU button ➡  retouch menu

Copy photographs in monochrome. [**Monochrome**] gives you a choice of the following monochrome tints:

Option	Description
[ <b>Black-and-white</b> ]	Copy photographs in black-and-white.
[ <b>Sepia</b> ]	Copy photographs in sepia.
[ <b>Cyanotype</b> ]	Copy photographs in blue-and-white monochrome.

- The effect can be previewed in the edit display.
- In the case of [**Sepia**] or [**Cyanotype**], color saturation can be adjusted using the multi selector. Press  to increase,  to decrease. The changes are reflected in the preview.
- Press  to save the retouched copy.



# Image Overlay

MENU button ➡  retouch menu

Image overlay combines existing photographs to create a single picture that is saved separately from the originals. One NEF (RAW) image can be overlaid on another using additive blending ([**Add**]), or multiple images can be combined using [**Lighten**] or [**Darken**].

## **Add**

Overlay two NEF (RAW) pictures to create a single new JPEG copy.



### **1** Select [**Image overlay**] in the retouch menu.

Highlight [**Image overlay**] and press







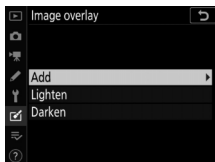

## 2 Select [Add].

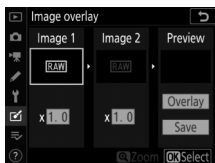

Highlight [**Add**] and press  to display image overlay options with [**Image 1**] highlighted.



## 3 Highlight the first image.

- Press  to display a picture-selection dialog listing only NEF (RAW) images, where you can use the multi selector to highlight the first photograph in the overlay.
- To view the highlighted picture full screen, press and hold the  button.
- To view pictures in other locations, press  () and choose the desired card and folder in the [**Choose slot and folder**] dialog.



## 4 Select the first picture.

Press **OK** to select the highlighted photograph and return to the preview display with the selected picture listed under **[Image 1]**.

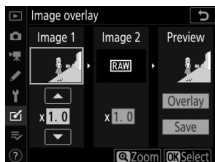

## 5 Select the second picture.

Press **⏪** and select **[Image 2]**, then select the second photo as described in Steps 3 and 4.

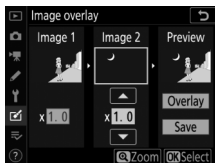

## 6 Adjust gain.

- The overlay of **[Image 1]** and **[Image 2]** can be previewed in the "Preview" column. Highlight **[Image 1]** or **[Image 2]** and optimize exposure for the overlay by pressing **⏪** or **⏩** to adjust gain.
- Choose from values between 0.1 and 2.0 in increments of 0.1.
- The effects are relative to the default value of 1.0 (no gain). For example, selecting 0.5 halves gain.

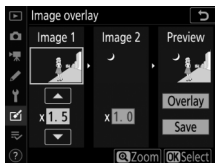

## 7 Select the “Preview” column.

- Press  $\leftarrow$  or  $\rightarrow$  to place the cursor in the “Preview” column.
- To proceed without previewing the overlay, highlight [Save] and press  $\odot$ .

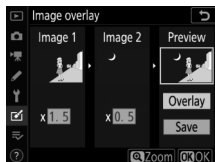

## 8 Preview the overlay.

- To preview the overlay, highlight [Overlay] and press  $\odot$ .
- To select new photos or adjust gain, press  $\text{Q}$  (Back). You will be returned to Step 6.

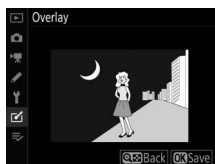

## 9 Save the overlay.

To save the overlay and display the resulting image, press  $\odot$  while the preview is displayed.



---

## ✓ [Add]

- Colors and brightness in the preview may differ from the final picture.
  - The overlay will include only NEF (RAW) pictures created with this camera. Pictures created with other cameras or in other formats cannot be selected.
  - The overlay is saved at an [Image quality] of [JPEG fine ★].
  - NEF (RAW) pictures can be combined only if they were created with the same options selected for:
    - [Image area] > [Choose image area],
    - [Image size] > [NEF (RAW)], and
    - [NEF (RAW) recording] > [NEF (RAW) bit depth]
  - The overlay has the same photo info (including date of recording, metering, shutter speed, aperture, exposure mode, exposure compensation, focal length, and image orientation) and values for white balance and Picture Control as the photograph selected for [Image 1]. Copyright information, however, is not copied to the new image. The comment is similarly not copied; instead, the comment currently active on the camera, if any, is appended.
-

## Lighten and Darken

The camera compares multiple selected pictures and selects only the brightest or darkest pixels at each point in the image to create a single new JPEG copy.

### **1 Select [Lighten] or [Darken].**

After selecting [**Image overlay**] in the retouch menu, highlight either [**Lighten**] or [**Darken**] and press .

- Lighten: The camera compares the pixels in each picture and uses only the brightest.



- Darken: The camera compares the pixels in each picture and uses only the darkest.



---

## 2 Choose how pictures are selected.

Option	Description
[Select individual images]	Select pictures for the overlay one-by-one.
[Select consecutive images]	Select two pictures; the overlay will include the two pictures and all images between them.
[Select folder]	The overlay will include all pictures in the selected folder.

---



## 3 Select the source slot.

- Highlight the slot with the card containing the desired pictures and press .
- You will not be prompted to select the slot if only one memory card is inserted.

---

## 4 Select pictures.

### **If you chose [Select individual images]:**

- Highlight pictures using the multi selector.
- To view the highlighted picture full screen, press and hold the  button.
- To select the highlighted picture, press the center of the multi selector. Selected pictures are marked by a  icon. To deselect the highlighted picture, press the center of the multi selector again; the  icon will no longer be displayed. The selected pictures will be combined using the option selected in Step 1.
- Press  to proceed once selection is complete.

### **If you chose [Select consecutive images]:**

- All pictures in a range chosen using the multi selector will be combined using the option selected in Step 1.
  - Use the center of the multi selector to select the first and last pictures in the desired range.
  - The first and last pictures are indicated by  icons and the pictures between them by  icons.
  - You can alter your selection by using the multi selector to highlight different pictures to serve as the first or last frame. Press the **Om** (☞/? ) button to choose the current picture as the new start or end point.
- To view the highlighted picture full screen, press and hold the **Ⓚ** button.
- Press **Ⓚ** to proceed once selection is complete.

### **If you chose [Select folder]:**

Highlight the desired folder and press **Ⓚ** to overlay all pictures in the folder using the option selected in Step 1.

---

## **5 Save the overlay.**

- A confirmation dialog will be displayed; highlight [**Yes**] and press **Ⓚ** to save the overlay and display the resulting picture.
- To interrupt the process before the overlay is complete, press **MENU**.



---

### ✓ [Lighten]/[Darken]

- The overlay will include only pictures created with this camera. Pictures created with other cameras cannot be selected.
  - The overlay will include only pictures created with the same options selected for [Image area] > [Choose image area].
  - Overlays that include pictures taken at different image quality settings will be saved at the same setting as the image with the highest image quality.
  - Overlays that include NEF (RAW) pictures will be saved at an image quality of [JPEG fine★].
  - Overlays that include NEF (RAW) pictures of different sizes will be the same size as the smallest picture.
  - If the overlay includes both NEF (RAW) and JPEG pictures, the NEF (RAW) pictures cannot be smaller than their JPEG counterparts. The overlay will be the same size as the JPEG pictures.
- 

## Trim Movie

MENU button ➡  retouch menu

Create a copy from which unwanted footage has been removed (📖 300).

## ☰ My Menu/🕒 Recent Settings

To view **[MY MENU]**, select the ☰ tab in the camera menus.

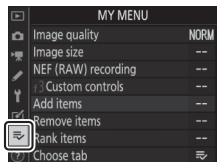

### ☰ My Menu: Creating a Custom Menu

My Menu can be used to create and edit a customized list of up to 20 items from the playback, photo shooting, movie shooting, Custom Settings, setup, and retouch menus. Items can be added, deleted, and reordered as described below.

## ■ Adding Items to My Menu

### 1 Select [Add items] in [≡ MY MENU].

Highlight [Add items] and press .

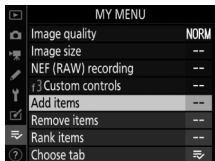

### 2 Select a menu.

Highlight the name of the menu containing the item you wish to add and press .

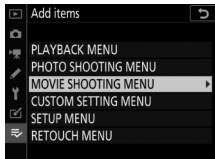

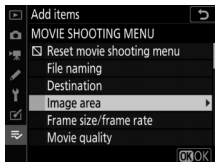

### 3 Select an item.

Highlight the desired menu item and press .



## 4 Position the new item.

Press  or  to position the new item and press  to add it to My Menu.



## 5 Add more items.

- The items currently displayed in My Menu are indicated by a check mark (✓).
- Items indicated by a  icon cannot be selected.
- Repeat Steps 1–4 to select additional items.

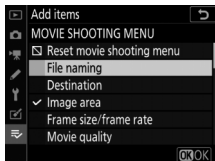

## ■ Removing Items from My Menu

### 1 Select [Remove items] in [≡ MY MENU].



Highlight [Remove items] and press .

### 2 Select items.

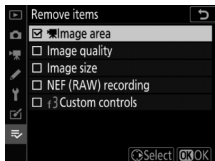
- Highlight items and press  to select () or deselect.
- Continue until all the items you wish to remove are selected ()





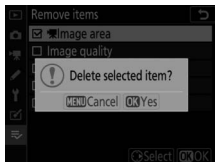

### 3 Remove the selected items.

Press ; a confirmation dialog will be displayed. Press  again to remove the selected items.



### ✓ Removing Items While in My Menu

Items can also be removed by highlighting them in [≡ MY MENU] and pressing the  () button; a confirmation dialog will be displayed. Press  () again to remove the selected item.

## ■ Reordering Items in My Menu

### 1 Select [Rank items] in [≡ MY MENU].



Highlight [Rank items] and press .

### 2 Select an item.

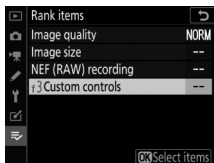
Highlight the item you wish to move and press .



### 3 Position the item.

- Press  or  to move the item up or down in My Menu and press .
- Repeat Steps 2–3 to reposition additional items.



## 4 Exit to [≡ MY MENU].

Press the MENU button to return to [≡ MY MENU].

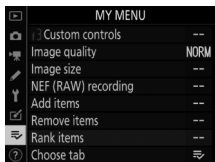
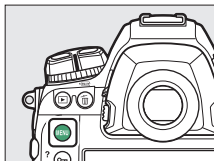



## ■ Displaying [RECENT SETTINGS]

### 1 Select [Choose tab] in [⇨ MY MENU].

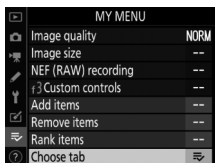
Highlight [Choose tab] and press .



### 2 Select [ RECENT SETTINGS].

- Highlight [ RECENT SETTINGS] in the [Choose tab] menu and press .
- The name of the menu will change from [MY MENU] to [RECENT SETTINGS].

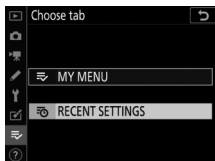





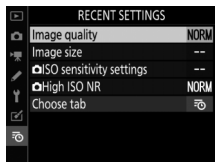

## **Recent Settings: Accessing Recently-Used Settings**

### **How Items Are Added to [RECENT SETTINGS]**



Menu items are added to the top of the [RECENT SETTINGS] menu as they are used. The twenty most recently settings are listed.



### **Removing Items from the Recent Settings Menu**

To remove an item from the [RECENT SETTINGS] menu, highlight it and press the  () button; a confirmation dialog will be displayed. Press  () again to remove the selected item.

### **Displaying My Menu**

Selecting [Choose tab] in the [RECENT SETTINGS] menu displays the items shown in Step 2 of “Displaying [RECENT SETTINGS]” (□ 996). Highlight  [MY MENU] and press  to view My Menu.

# Troubleshooting

## Before Contacting Customer Support

You may be able to resolve any issues with the camera by following the steps below. Check this list before consulting your retailer or Nikon-authorized service representative.

---

**STEP 1** Check the common problems listed in the following sections:

- “Problems and Solutions” (□ 1000)
  - “Alerts and Error Messages” (□ 1012)
- 

**STEP 2** Turn the camera off and remove the battery, then wait about a minute, re-insert the battery and turn the camera on.

- ✓ The camera may continue to write data to the memory card after shooting. Wait at least a minute before removing the battery.
- 

**STEP 3** Search Nikon websites.

- For support information and answers to frequently asked questions, visit the website for your country or region (□ lii).
  - To download the latest firmware for your camera, visit: <https://downloadcenter.nikonimglib.com/>
- 

**STEP 4** Consult a Nikon-authorized service representative.

---

---

## ✓ Restoring Default Settings

- Depending on current settings, some menu items and other features may be unavailable. To access menu items that are grayed out or features that are otherwise unavailable, try restoring default settings using the **[Reset all settings]** item in the setup menu.
  - Note, however, that wireless network profiles, copyright information, and other user-generated entries will also be reset. Once reset, settings cannot be restored.
-

# Problems and Solutions

Solutions to some common issues are listed below.

## **Battery/Display**

---

### ● **The camera is on but does not respond:**

- Wait for recording and other operations to end.
  - If the problem persists, turn the camera off.
  - If the camera does not turn off, remove and reinsert the battery.
  - If you are using an AC adapter, disconnect and reconnect the AC adapter.
    - Any data currently being recorded will be lost.
    - Data that have already been recorded are not affected by removing or disconnecting the power source.
- 

### ● **The viewfinder is out of focus:**

- Rotate the diopter adjustment control to adjust viewfinder focus.
  - If adjusting viewfinder focus does not correct the problem, set the autofocus mode to **AF-S** and the AF-area mode to [**Single-point AF**]. Next, select the center focus point, choose a high-contrast subject, and focus using autofocus. With the camera in focus, use the diopter adjustment control to bring the subject into clear focus in the viewfinder.
  - If necessary, viewfinder focus can be further adjusted using optional corrective lenses.
-

---

● **The viewfinder is dark:**

Is the battery charged? The viewfinder may dim if the battery is exhausted or not inserted (📖 28, 47).

---

● **The display in the viewfinder, control panel, or monitor turns off without warning:**

Choose longer delays for Custom Setting c2 [**Standby timer**] or c4 [**Monitor off delay**].

---

● **The display in control panel or viewfinder is dim and unresponsive:**

The response times and brightness of these displays vary with temperature.

---

● **Patterns appear in the viewfinder:**

The viewfinder display may turn red when a focus point is highlighted, but this is normal for this type of viewfinder and does not indicate a malfunction.

---

## Shooting

---

● **The camera takes time to turn on:**

More time will be needed to find files if the memory card contains large numbers of files or folders.

---

● **The shutter cannot be released:**

- Is a memory card inserted, and if so, does it have space available?
  - When a CPU lens of a type other than G or E is attached, the shutter cannot be released unless the aperture ring is locked at minimum aperture (the highest f-number). If **fE E** is displayed in the top control panel, select [**Aperture ring**] for Custom Setting f6 [**Customize command dials**] > [**Aperture setting**] and adjust aperture using the lens aperture ring.
  - If you selected mode **S** after selecting a shutter speed of **b u l b** (Bulb) or **- -** (Time) in mode **M**, choose a different shutter speed.
  - Is [**Release locked**] selected for [**Slot empty release lock**] in the setup menu?
- 

● **The camera is slow to respond to the shutter-release button:**

Select [**Off**] for Custom Setting d5 [**Exposure delay mode**].

---

● **Burst shooting is unavailable:**

Burst shooting cannot be used in conjunction with HDR.

---

---

● **Photos are out of focus:**

- Is the camera in manual focus mode? To enable autofocus, rotate the focus-mode selector to **AF**.
- Autofocus does not perform well under the following conditions. In these cases, use manual focus or focus lock. Autofocus does not perform well if: there is little or no contrast between the subject and the background, the focus point contains objects at different distances from the camera, the subject is dominated by regular geometric patterns, the focus point contains areas of sharply contrasting brightness, background objects appear larger than the subject, or the subject contains many fine details.

---

● **The beep does not sound:**

- A beep does not sound when the camera focuses with **AF-C** selected for autofocus mode.
- Select an option other than **[Off]** for **[Beep options]** > **[Beep on/off]** in the setup menu.

---

● **The full range of shutter speeds is not available:**

Using a flash restricts the range of shutter speeds available. Flash sync speed can be set to values of  $1/250$ – $1/60$  s using Custom Setting e1 **[Flash sync speed]**. When using flash units that support auto FP high-speed sync, choose **[1/250 s (Auto FP)]** for a full range of shutter speeds.

---

---

● **Focus does not lock when the shutter-release button is pressed halfway:**

If **AF-C** is selected for autofocus mode, focus can be locked by pressing the center of the sub-selector.

---

● **Focus-point selection is not available:**

- Is the focus selector lock in the **L** (lock) position?
  - Focus-point selection is not available when [**Auto-area AF**] is selected for AF-area mode.
  - Focus point selection is not available in playback mode or when menus are in use.
  - Has the standby timer expired? To enable focus-point selection, press the shutter-release button halfway.
- 

● **AF mode selection is not available:**

Select [**No restrictions**] for Custom Setting a15 [**Autofocus mode restrictions**].

---

● **The camera is slow to record photos:**

Is [**On**] selected for [**Long exposure NR**] in the photo shooting menu?

---



---

● **“Noise” (bright spots, randomly-spaced bright pixels, fog, or lines) appears in photos:**

- To reduce noise, adjust settings such as ISO sensitivity, shutter speed, or Active D-Lighting.
  - At high ISO sensitivities, noise may become more noticeable in long exposures or in pictures recorded when the camera temperature is elevated.
-

---

● **Photographs and movies do not appear to have the same exposure as the preview shown in the monitor during live view:**

Changes to monitor brightness during live view have no effect on images recorded with the camera.

---

● **Flicker or banding appears in the display during movie recording:**

Select [**Flicker reduction**] in the movie shooting menu and choose an option that matches the frequency of the local AC power supply.

---

● **Bright regions or bands appear in live view:**

Bright regions or bands may occur if a flashing sign, flash, or other light source with brief duration is used during live view.

---

● **Smudges appear in photographs:**

- Are there smudges on the front or rear (mount-side) lens elements?
- Is there foreign matter on the low-pass filter? Perform image sensor cleaning.

---

● **Live view ends unexpectedly or does not start:**

- Live view may end automatically to prevent damage to the camera's internal circuits, for example if:
    - The ambient temperature is high
    - The camera has been used for extended periods in live view or to record movies
    - The camera has been used in continuous release modes for extended periods
  - If the camera is running hot and live view does not start, wait for the internal circuits to cool and then try again. Note that the camera may feel warm to the touch, but this does not indicate a malfunction.
-

---

● **“Noise” (bright spots, randomly-spaced bright pixels, fog, or lines) appears during live view:**

- Randomly-spaced bright pixels, fog, or bright spots may arise as a result of increases in the temperature of the camera’s internal circuits during live view. Exit live view when the camera is not in use.
- Randomly-spaced bright pixels, fog, lines or unexpected colors may appear if you press the  button to zoom in on the view through the lens during live view.
- In movies, the amount and distribution of randomly-spaced bright pixels, fog, and bright spots are affected by the option selected for **[Frame size/frame rate]** in the movie shooting menu.
- Note that the distribution of noise in the monitor may differ from that in the final picture.

---

● **Monitor hue changes sharply during live view:**

Monitor hue may change sharply at high sensitivities (Hi 0.3 to Hi 5) during burst photography or immediately after the shutter is released; this does not indicate a malfunction. The display will shortly return to normal. Pictures taken with the camera are unaffected.

---

● **The camera cannot measure a value for preset manual white balance:**

The subject is too dark or too bright.

---

● **Certain pictures cannot be selected as sources for preset white balance:**

Pictures created with cameras of other types cannot serve as sources for preset manual white balance.

---

---

● **White balance (WB) bracketing is unavailable:**

- White balance bracketing is not available when an NEF (RAW) or NEF + JPEG option is selected for image quality.
- White balance bracketing cannot be used in multiple exposure and HDR modes.

---

● **The effects of [Set Picture Control] differ from image to image:**

[Auto] is selected for [Set Picture Control] or as the basis for a custom Picture Control created using [Manage Picture Control], or [A] (auto) is selected for [Quick sharp], [Contrast], or [Saturation]. For consistent results over a series of photographs, choose a setting other than [A] (auto).

---

● **The option selected for metering cannot be changed:**

The option selected for metering cannot be changed during exposure lock.

---

● **Exposure compensation is not available:**

Changes to exposure compensation in mode **M** apply only to the exposure indicator and have no effect on shutter speed or aperture.

---

● **Uneven shading may appear in long exposures:**

Uneven shading may appear in long exposures shot at shutter speeds of **b** **u** **l** **b** (Bulb) or - - (Time). The effect can be mitigated by selecting [On] for [Long exposure NR] in the photo shooting menu.

---

● **Sound is not recorded with movies:**

Is [Microphone off] selected for [Microphone sensitivity] in the movie shooting menu?

---

## **Playback**

---

● **NEF (RAW) pictures are not visible during playback:**

The camera displays only the JPEG copies of pictures taken with [NEF (RAW) + JPEG fine★], [NEF (RAW) + JPEG fine], [NEF (RAW) + JPEG normal★], [NEF (RAW) + JPEG normal], [NEF (RAW) + JPEG basic★], or [NEF (RAW) + JPEG basic] selected for [Image quality].

---

● **Pictures taken with other cameras are not displayed:**

Pictures recorded with other types of camera may not display correctly.

---

● **Not all photos are visible during playback:**

Select [All] for [Playback folder] in the playback menu.

---

● **“Tall” (portrait) orientation photos are displayed in “wide” (landscape) orientation:**

- Is [Off] selected for [Rotate tall] in the playback menu?
  - Auto image rotation is not available during image review.
  - Camera orientation may not be correctly recorded in photos taken with the camera pointing up or down.
- 

● **Pictures cannot be deleted:**

Are the pictures protected?

---

● **Pictures cannot be retouched:**

- The pictures cannot be further edited with this camera.
  - There is insufficient space on the memory card to record the retouched copy.
- 

● **The camera displays the message, [Folder contains no images]:**

Select [All] for [Playback folder] in the playback menu.

---

● **Pictures are not displayed on HDMI devices:**

Confirm that an HDMI cable is correctly connected.

---

---

● **The Image Dust Off option in Capture NX-D does not have desired effect:**

Image sensor cleaning changes the position of dust on the low-pass filter and will not have the desired effect if:

- Dust off reference data recorded after image sensor cleaning is performed are used with photographs taken before image sensor cleaning is performed
- Dust off reference data recorded before image sensor cleaning is performed are used with photographs taken after image sensor cleaning is performed

---

● **The effects of [Set Picture Control], [Active D-Lighting], or [Vignette control] are not visible:**

In the case of NEF (RAW) images, the effect can only be viewed using Nikon software. View NEF (RAW) images using Capture NX-D or ViewNX-i.

---

● **Pictures cannot be copied to a computer:**

Depending on the operating system, you may be unable to upload pictures when the camera is connected to a computer. Copy pictures from the memory card to a computer using a card reader or other device.

---

## **Bluetooth and Wi-Fi (Wireless Networks)**

---

### ● **Smart devices do not display the camera SSID (network name):**

- Navigate to the setup menu and confirm both that [**Disable**] is selected for [**Airplane mode**] and that [**Enable**] is selected for [**Connect to smart device**] > [**Pairing (Bluetooth)**] > [**Bluetooth connection**].
- Confirm that the [**Connect to smart device**] > [**Wi-Fi connection**] is enabled in the setup menu.
- Try disabling and re-enabling wireless network features on the smart device.

### ● **The camera cannot connect to printers and other wireless devices:**

The camera cannot establish wireless connections with devices other than smartphones, tablets, and computers.

## **Miscellaneous**

---

### ● **The date of recording is not correct:**

Is the camera clock set correctly? The clock is less accurate than most watches and household clocks; check it regularly against more accurate timepieces and reset as necessary.

### ● **Menu items cannot be selected:**



- Some items are not available at certain combinations of settings.
- The [**Battery info**] item in the setup menu is not available when camera is powered by an optional power connector and AC adapter.

## Alerts and Error Messages



This section lists the alerts and error messages that appear in the viewfinder, top control panel, and monitor.

### Alerts

The following alerts appear in the top control panel and viewfinder:

Alert		Problem/solution
Top control panel	Viewfinder	
$fE E$ (flashes)	$fE E$ (flashes)	<b>Lens aperture ring is not set to minimum aperture.</b> Set lens aperture ring to minimum aperture (highest f-number).
		<b>Low battery.</b> Ready spare battery.



Alert		Problem/solution
Top control panel	Viewfinder	
 (flashes)	 (flashes)	<p><b>Battery exhausted.</b></p> <ul style="list-style-type: none"> <li>• Replace with spare battery.</li> <li>• Charge battery.</li> </ul> <hr/> <p><b>Battery info not available.</b></p> <ul style="list-style-type: none"> <li>• Battery cannot be used. Contact Nikon-authorized service representative.</li> <li>• Battery level is extremely low; charge battery.</li> </ul> <hr/> <p><b>Battery cannot supply data to camera.</b>            Replace third-party batteries with genuine Nikon batteries.</p> <hr/> <p><b>High battery temperature.</b>            Remove battery and wait for it to cool.</p>
 (flashes)	—	<p><b>Camera clock is not set.</b>            Set camera clock.</p>
$\Delta F$	$\Delta F$	<p><b>Aperture shown in stops from maximum aperture. No lens attached, or non-CPU lens attached without specifying maximum aperture.</b>            Aperture value will be displayed if maximum aperture is specified.</p>

Alert		Problem/solution
Top control panel	Viewfinder	
—	▶◀ (flashes)	<b>Camera unable to focus using autofocus.</b> Change composition or focus manually.
b u l b (flashes)	b u l b (flashes)	<b>b u l b (Bulb) selected in mode S.</b> <ul style="list-style-type: none"> <li>• Change shutter speed.</li> <li>• Select mode <b>M</b>.</li> </ul>
- - (flashes)	- - (flashes)	<b>- - (Time) selected in mode S.</b> <ul style="list-style-type: none"> <li>• Change shutter speed.</li> <li>• Select mode <b>M</b>.</li> </ul>
b u s y (flashes)	b s y (flashes)	<b>Processing in progress.</b> Wait for processing to complete.
—	⚡ (flashes)	<b>Flash has fired at full power.</b> Photo may be underexposed. Check distance to subject and settings such as aperture, flash range, and ISO sensitivity.

Alert		Problem/solution
Top control panel	Viewfinder	
(Exposure indicators and shutter speed or aperture display flash)		<p><b>Subject too bright; limits of camera exposure metering system exceeded.</b></p> <ul style="list-style-type: none"> <li>• Lower ISO sensitivity.</li> <li>• Mode <b>P</b>: Use third-party ND (neutral density) filter (filter can also be used if alert is still displayed after following settings are adjusted in mode <b>S</b> or <b>A</b>).</li> <li>• Mode <b>S</b>: Choose faster shutter speed.</li> <li>• Mode <b>A</b>: Choose smaller aperture (higher f-number).</li> </ul>
		<p><b>Subject too dark; limits of camera exposure metering system exceeded.</b></p> <ul style="list-style-type: none"> <li>• Increase ISO sensitivity.</li> <li>• Mode <b>P</b>: Use optional flash unit (flash can also be used if alert is still displayed after following settings are adjusted in mode <b>S</b> or <b>A</b>).</li> <li>• Mode <b>S</b>: Choose slower shutter speed.</li> <li>• Mode <b>A</b>: Choose wider aperture (lower f-number).</li> </ul>

Alert		Problem/solution
Top control panel	Viewfinder	
 (flashes)	—	<p><b>Flash unit that does not support red-eye reduction attached and flash mode set to red-eye reduction or red-eye reduction with slow sync.</b></p> <ul style="list-style-type: none"> <li>• Use flash unit that supports red-eye reduction.</li> <li>• Change flash mode.</li> </ul>
<b>F u l l l</b> (flashes)	<b>F u l</b> (flashes)	<p><b>Memory insufficient to record further photos.</b></p> <ul style="list-style-type: none"> <li>• Delete pictures from memory card until there is room for additional pictures to be recorded. Copy pictures you wish to keep to computer or other device before proceeding.</li> <li>• Insert new memory card.</li> </ul> <hr/> <p><b>Camera has run out of file numbers.</b></p> <ul style="list-style-type: none"> <li>• Delete pictures from memory card until there is room for additional pictures to be recorded. Copy pictures you wish to keep to computer or other device before proceeding.</li> <li>• Insert new memory card.</li> </ul>
<b>E r r</b> (flashes)	<b>E r r</b> (flashes)	<p><b>Camera malfunction.</b></p> <p>Press shutter-release button again. If error persists or appears frequently, consult Nikon-authorized service representative.</p>

## **Error Messages**

The following alerts appear in the monitor and top control panel:

<b>Alert</b>		<b>Problem/solution</b>
<b>Monitor</b>	<b>Top control panel</b>	
No memory card.	[ - E - ]	<b>Memory card not inserted or inserted incorrectly.</b> Check that card is inserted correctly.
Cannot access this memory card. Insert another card.	[ Err ], [ Err ] (flashes)	<b>Error accessing memory card.</b> <ul style="list-style-type: none"><li>• Check that camera supports memory card.</li><li>• If error persists after card has been repeatedly ejected and reinserted, card may be damaged. Contact retailer or Nikon-authorized service representative.</li></ul> <b>Unable to create new folder.</b> <ul style="list-style-type: none"><li>• Delete pictures from memory card until there is room for additional pictures to be recorded. Copy pictures you wish to keep to computer or other device before proceeding.</li><li>• Insert new memory card.</li></ul>

Alert		Problem/solution
Monitor	Top control panel	
This card is not formatted. Format the card.	{ <b>F or</b> } (flashes)	<b>Memory card is not correctly formatted.</b> <ul style="list-style-type: none"> <li>• Format memory card.</li> <li>• Replace with correctly-formatted memory card.</li> </ul>
Unable to start live view. Please wait.	—	<b>Camera's internal temperature is elevated.</b> Suspend shooting until camera has cooled.
Folder contains no images.	—	<b>Folder contains no pictures.</b> Insert memory card that contains pictures.
		<b>No pictures in folder selected for playback.</b> Use [ <b>Playback folder</b> ] item in playback menu to select folder that contains pictures.
All images are hidden.	—	<b>All pictures in current folder are hidden.</b> Use [ <b>Hide image</b> ] item in playback menu to reveal pictures.

Alert		Problem/solution
Monitor	Top control panel	
Cannot display this file.	—	<b>File has been modified using computer application or does not conform to DCF file standard.</b> Do not overwrite images using computer applications.
		<b>File is corrupt.</b> Do not overwrite images using computer applications.
Cannot select this file.	—	<b>Selected picture cannot be retouched.</b> Retouch options are available only with pictures taken with or previously retouched on camera.
This movie cannot be edited.	—	<b>Selected movie cannot be edited.</b> <ul style="list-style-type: none"> <li>• Movies created with other devices cannot be edited.</li> <li>• Movies under two seconds long cannot be edited.</li> </ul>

Alert		Problem/solution
Monitor	Top control panel	
<p>This file cannot be saved to the destination memory card. See the camera's user's manual for details.</p>	—	<p><b>Files 4 GB or larger can only be saved to memory cards formatted for exFAT. They cannot be saved to cards formatted for other file systems, such as FAT32.</b></p> <p>Use a memory card with a capacity over 32 GB formatted in the camera or keep file size to under 4 GB.</p>



# Technical Notes

## Camera Displays

For illustrative purposes, the displays are shown with all indicators lit.

### The Viewfinder

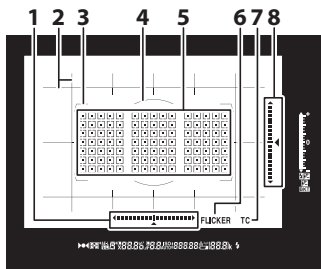

- 1 Roll indicator<sup>1,2</sup> (☐ 862)
- 2 Framing grid<sup>3</sup> (☐ 832)
- 3 AF-area brackets (☐ 50, 164)
- 4 12-mm reference circle for center-weighted metering (☐ 111, 178)

- 5 Focus points (☐ 164)
- Spot metering targets (☐ 111, 178)
- AF-area mode indicator (☐ 157)
- 6 Flicker detection (☐ 772)
- 7 Teleconverter indicator<sup>4</sup>
- 8 Pitch indicator<sup>1,5</sup> (☐ 862)

- 1 Displayed by pressing button to which **[Viewfinder virtual horizon]** has been assigned using Custom Setting f3 (**[Custom controls]**;  850).
- 2 Functions as a pitch indicator when the camera is rotated to take pictures in “tall” (portrait) orientation.
- 3 Displayed when **[On]** is selected for Custom Setting d11 **[Framing grid display]**.
- 4 Displayed only when a lens with a built-in teleconverter is attached and the teleconverter is in use.
- 5 Functions as a roll indicator when the camera is rotated to take pictures in “tall” (portrait) orientation.

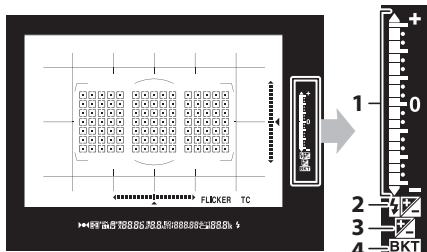

- 1** Exposure indicator  
 Exposure (☞ 190)  
 Exposure compensation  
 (☞ 117, 199)  
 Exposure and flash  
 bracketing progress  
 indicator (☞ 251)

- 2** Flash compensation indicator  
 (☞ 133, 653)

- 3** Exposure compensation  
 indicator (☞ 117, 199)

- 4** Bracketing indicator  
 Exposure and flash  
 bracketing (☞ 251)  
 WB bracketing (☞ 259)  
 ADL bracketing (☞ 265)

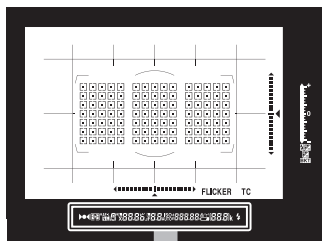

- |   |                                     |    |   |
|---|-------------------------------------|----|---|
| 1 | Focus indicator (☞ 50, 176)         | 9  | ISO sensitivity indicator (☞ 114, 213)      |
| 2 | Metering (☞ 111, 178)               |    | Auto ISO sensitivity indicator (☞ 116, 220) |
| 3 | Autoexposure (AE) lock (☞ 170, 196) | 10 | ISO sensitivity (☞ 114, 213)                |
| 4 | Exposure mode (☞ 108, 182)          |    | Active D-Lighting amount (☞ 281)            |
| 5 | Shutter speed lock icon (☞ 194)     | 11 | AF-area mode (☞ 101, 157)                   |
| 6 | Shutter speed (☞ 185, 188)          |    | Network display (☞ 593)                     |
| 7 | Autofocus mode (☞ 98, 149)          |    |   |
| 7 | Aperture lock icon (☞ 194)          |    |   |
| 8 | Aperture (f-number; ☞ 186, 188)     |    |   |
|   | Aperture (number of stops; ☞ 187)   |    |   |

12	Number of exposures remaining (☞ 48, 1120) Number of shots remaining before memory buffer fills (☞ 207, 1120) Preset white balance recording indicator (☞ 235) Exposure compensation value (☞ 117, 199) Flash compensation value (☞ 133, 653) PC mode indicator (☞ 1071)	13	"k" (appears when memory remains for over 1000 exposures; ☞ 48)
		14	Flash-ready indicator * (☞ 641)
		15	Low battery warning (☞ 47)
		16	Aperture stop indicator (☞ 187)
		17	Flash sync indicator (☞ 836)
		18	FV lock indicator (☞ 655, 840)

\* Displayed when an optional flash unit is attached (☞ 641). The flash-ready indicator lights when the flash is charged.

---

### ✓ The Viewfinder

When the battery is exhausted or no battery is inserted, the display in the viewfinder will dim. The display will return to normal when a charged battery is inserted.

### ✓ Temperature Extremes

The brightness of the control panel and viewfinder displays varies with temperature, and response times may drop when the temperature is low; the displays will return to normal at room temperature.

---

## The Information Display

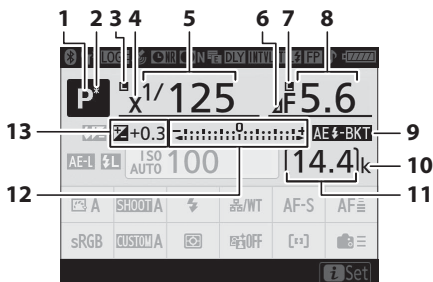

1	Exposure mode (☞ 108, 182)	10	"k" (appears when memory remains for over 1000 exposures; ☞ 48)
2	Flexible program indicator (☞ 184)	11	Number of exposures remaining (☞ 48, 1120)
3	Shutter speed lock icon (☞ 194)	12	Exposure indicator Exposure (☞ 190) Exposure compensation (☞ 199) Exposure and flash bracketing (☞ 251) WB bracketing (☞ 259) ADL bracketing (☞ 265)
4	Flash sync indicator (☞ 836)	13	Exposure compensation indicator (☞ 117, 199) Exposure compensation value (☞ 117, 199)
5	Shutter speed (☞ 185, 188)		
6	Aperture stop indicator (☞ 187)		
7	Aperture lock icon (☞ 194)		
8	Aperture (f-number; ☞ 186, 188) Aperture (number of stops; ☞ 187)		
9	Exposure and flash bracketing indicator (☞ 251) WB bracketing indicator (☞ 259) ADL bracketing indicator (☞ 265) HDR indicator (☞ 283) Multiple exposure indicator (☞ 318)		

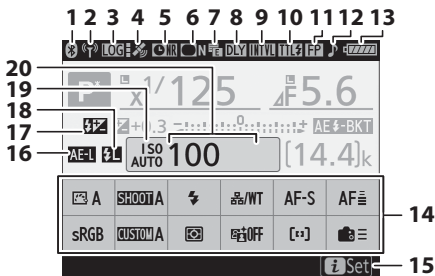

- |   |  |
|---|--|
| <p><b>1</b> Bluetooth connection indicator (☐ 469, 929)<br/>Airplane mode (☐ 929)</p> <p><b>2</b> Wi-Fi connection indicator (☐ 461, 931, 932)</p> <p><b>3</b> Track log indicator (☐ 384)</p> <p><b>4</b> Satellite signal indicator (☐ 386)</p> <p><b>5</b> Long exposure noise reduction indicator (☐ 767)</p> <p><b>6</b> Vignette control indicator (☐ 769)</p> <p><b>7</b> Electronic front-curtain shutter (☐ 827)</p> <p><b>8</b> Exposure delay mode (☐ 827)</p> <p><b>9</b> Interval timer indicator (☐ 331)<br/>⌚ (“clock not set”) indicator (☐ 1028)</p> | <p><b>10</b> Flash control mode (☐ 645)</p> <p><b>11</b> FP indicator (☐ 836)</p> <p><b>12</b> “Beep” indicator (☐ 923)</p> <p><b>13</b> Battery indicator (☐ 47)</p> <p><b>14</b> <b>i</b> menu display area (☐ 88)</p> <p><b>15</b> Guide (☐ 1028)</p> <p><b>16</b> Autoexposure (AE) lock (☐ 170, 196)</p> <p><b>17</b> Flash compensation indicator (☐ 653)</p> <p><b>18</b> FV lock indicator (☐ 655)</p> <p><b>19</b> ISO sensitivity indicator (☐ 114, 213)<br/>Auto ISO sensitivity indicator (☐ 116, 220)</p> <p><b>20</b> ISO sensitivity (☐ 114, 213)</p> |
|---|--|

---

## ✓ The ⌚ Icon

A flashing ⌚ icon indicates that the camera clock has been reset. The date and time recorded with new photographs will not be correct; use the [Time zone and date] > [Date and time] option in the setup menu to set the clock to the correct time and date.

---

## ✍ Using the *i* Menu

To access the *i* menu, press the *i* button or tap the guide in the information display. Press the *i* button again or press the **info** button to return to the information display when settings are complete.





# Live View (Still Photography/Movies)

## ■ Still Photography

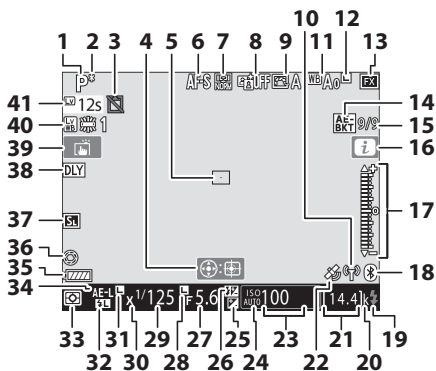

**1** Exposure mode (📖 108, 182)

**2** Flexible program indicator  
(📖 184)

**3** “No memory card” indicator

**4** Subject tracking AF (📖 160)

**5** Focus point (📖 164)

**6** Autofocus mode (📖 98, 151)

**7** AF-area mode (📖 101, 160)

**8** Active D-Lighting (📖 281)

**9** Picture Control (📖 125, 271)

**10** Wi-Fi connection indicator  
(📖 461, 931, 932)

**11** White balance (📖 121, 221)

**12** “Auto white balance locked”  
indicator (📖 850)

13	Image area (📄 136)	21	Number of exposures remaining (📄 48, 1120)
14	Exposure and flash bracketing indicator (📄 251)	22	Satellite signal indicator (📄 386)
	WB bracketing indicator (📄 259)	23	ISO sensitivity (📄 114, 213)
	ADL bracketing indicator (📄 265)	24	ISO sensitivity indicator (📄 114, 213)
	HDR indicator (📄 283)		Auto ISO sensitivity indicator (📄 116, 220)
	Multiple exposure indicator (📄 318)	25	Exposure compensation indicator (📄 117, 199)
15	Position of current frame in exposure/flash bracketing sequence (📄 251)	26	Flash compensation indicator (📄 133, 653)
	Position of current frame in white balance bracketing sequence (📄 259)	27	Aperture (📄 186, 188)
	ADL bracketing amount (📄 265)	28	Aperture lock icon (📄 194)
	HDR exposure differential (📄 283)	29	Shutter speed (📄 185, 188)
	Number of exposures (multiple exposure; 📄 318)	30	Flash sync indicator (📄 836)
16	⚡ icon (📄 88)	31	Shutter speed lock icon (📄 194)
17	Exposure indicator (📄 190)	32	FV lock indicator (📄 655)
18	Bluetooth connection indicator (📄 469, 929)	33	Metering (📄 111, 178)
	Airplane mode (📄 929)	34	Autoexposure (AE) lock (📄 170, 196)
19	Flash-ready indicator (📄 641)	35	Battery indicator (📄 47)
20	“k” (appears when memory remains for over 1000 exposures; 📄 48)	36	Maximum aperture indicator (📄 62)
		37	Silent photography (📄 374) Electronic front-curtain shutter (📄 827)
		38	Exposure delay mode (📄 827)

39	Touch shooting (📖 18)
40	Photo live view display WB (📖 848)
41	Time remaining (📖 60) Temperature warning (📖 1031)

---

### ✔ Temperature Warnings

- If the camera temperature becomes elevated, a temperature warning and count-down timer will be displayed. When the timer reaches zero, the monitor will turn off.
  - The timer turns red when the thirty second mark is reached. In some cases, the timer may be displayed immediately after the camera is turned on.
-

## ■ Filming

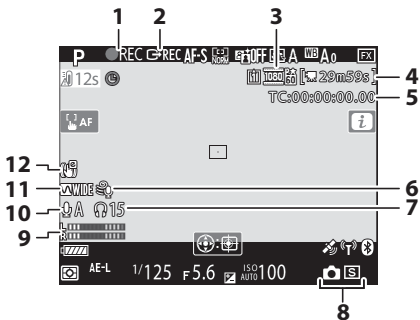

1	Recording indicator (📖 63) "No movie" indicator (📖 297)	7	Headphone volume (📖 794)
2	External recording control (📖 455)	8	Release mode (still photography; 📖 70)
3	Frame size and rate/image quality (📖 294)	9	Sound level (📖 66)
4	Time remaining (📖 294)	10	Microphone sensitivity (📖 792)
5	Time code (📖 795)	11	Frequency response (📖 793)
6	Wind noise reduction (📖 794)	12	Electronic VR indicator (📖 791)

## The Top Control Panel

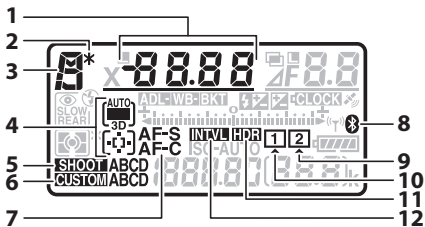

- |          |  |           |   |
|----------|--|-----------|---|
| <b>1</b> | Shutter speed (☞ 185, 188)<br>AF-area mode (☞ 101, 157)<br>Exposure compensation value (☞ 117, 199)<br>Flash compensation value (☞ 133, 653)<br>Number of shots in exposure and flash bracketing sequence (☞ 251)<br>Number of shots in WB bracketing sequence (☞ 259)<br>Overlay mode (☞ 328)<br>Number of intervals for interval-timer photography (☞ 331)<br>Focal length (non-CPU lenses; ☞ 383) | <b>3</b>  | Exposure mode (☞ 108, 182)  |
| <b>2</b> | Flexible program indicator (☞ 184)   | <b>4</b>  | AF-area mode indicator (☞ 101, 163)                                 |
|          |  | <b>5</b>  | Photo shooting menu bank (☞ 752)                                    |
|          |  | <b>6</b>  | Custom settings bank (☞ 802)  |
|          |  | <b>7</b>  | Autofocus mode (☞ 98, 149)  |
|          |  | <b>8</b>  | Bluetooth connection indicator (☞ 469, 929)                         |
|          |  | <b>9</b>  | Memory card icon (Slot 2; ☞ 41, 48)                                 |
|          |  | <b>10</b> | Memory card icon (Slot 1; ☞ 41, 48)                                 |
|          |  | <b>11</b> | HDR indicator (☞ 283)   |
|          |  | <b>12</b> | Interval timer indicator (☞ 331)<br>Time-lapse on indicator (☞ 358) |

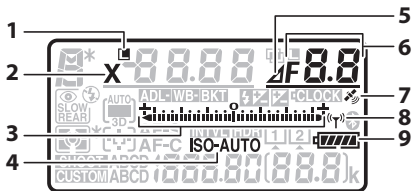

1	Shutter-speed lock icon (□ 194)	6	Aperture (f-number; □ 186, 188) Aperture (number of stops; □ 187)
2	Flash sync indicator (□ 836)	7	Bracketing increment (exposure and flash bracketing; □ 251)
3	Exposure indicator Exposure (□ 190) Exposure compensation (□ 117, 199) Exposure and flash bracketing (□ 251) WB bracketing (□ 259) ADL bracketing (□ 265)	8	Bracketing increment (WB bracketing; □ 259)
4	ISO sensitivity indicator (□ 114, 213) Auto ISO sensitivity indicator (□ 116, 220)	9	Number of shots in ADL bracketing sequence (□ 265)
5	Aperture stop indicator (□ 187)		Number of shots per interval (□ 331)
			HDR exposure differential (□ 291)
			Number of exposures (multiple exposure; □ 328)
			Maximum aperture (non-CPU lenses; □ 383)
			PC mode indicator (□ 1071)
		7	Satellite signal indicator (□ 386)
		8	Wi-Fi connection indicator (□ 461, 931, 932)
		9	Battery indicator (□ 47)

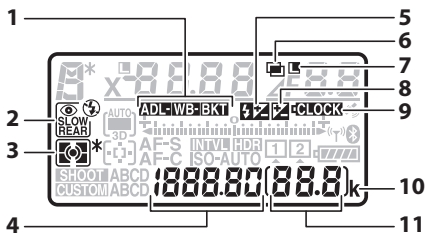

- 1** Bracketing indicator  
Exposure and flash bracketing (☞ 251)  
WB bracketing (☞ 259)  
ADL bracketing (☞ 265)
- 2** Flash mode (☞ 131, 648)
- 3** Metering (☞ 111, 178)
- 4** Frame count (☞ 10)  
ISO sensitivity (☞ 114, 213)  
White balance preset number (☞ 234)
- 5** Flash compensation indicator (☞ 133, 653)
- 6** Multiple exposure indicator (☞ 321)
- 7** Aperture lock icon (☞ 194)
- 8** Exposure compensation indicator (☞ 117, 199)
- 9** Clock battery indicator (☞ 46, 1083)

- 10** "k" (appears when memory remains for over 1000 exposures; ☞ 48)
- 11** Number of exposures remaining (☞ 48, 1120)  
Number of shots remaining before memory buffer fills (☞ 207, 1120)  
Preset white balance recording indicator (☞ 234)  
Active D-Lighting amount (☞ 281)  
HDR mode (☞ 291)  
Multiple exposure mode (☞ 328)  
Manual lens number (☞ 383)  
Time-lapse recording indicator (☞ 358)  
Camera control mode (☞ 595)

## The Rear Control Panel

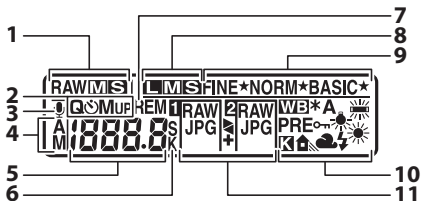

- 1 Image size (NEF/RAW; 147)  
Size for JPEG images recorded to card in Slot 2 ( 308)
- 2 Release mode ( 109, 203)
- 3 Voice memo status indicator ( 437, 441)
- 4 Voice memo recording mode ( 440)
- 5 Release mode ( 109, 203)  
Continuous shooting speed ( 109, 203, 824)  
Self-timer shot count/self-timer delay ( 209, 823)  
Number of exposures remaining ( 48, 1120)  
Frame count ( 833)  
Length of voice memo ( 437)  
Sub-option selected for **[Auto]** or **[Fluorescent]** white balance ( 121, 225)  
White balance preset number ( 234)  
Color temperature ( 231)  
PC mode indicator ( 1071)

- 6 "k" (appears when memory remains for over 1000 exposures; 48)  
Color temperature indicator ( 231)  
Supplementary seconds display ( 209, 437)
- 7 "Remaining" indicator ( 1120)
- 8 Image size (JPEG; 120, 145)
- 9 Image quality ( 118, 144)
- 10 White balance ( 121, 221)  
White balance fine-tuning indicator ( 227)  
"Auto white balance locked" indicator ( 850)  
White balance preset protection indicator ( 240)
- 11 Role played by memory card in Slot 2 ( 308)  
Image quality ( 118, 144)



## Compatible F Mount Lenses

CPU lenses are recommended (but note that IX-NIKKOR lenses cannot be used). Types G, E, and D, which grant access to a full range of camera features, are particularly recommended.

### CPU lenses

Lens <sup>1</sup> /accessory	Autofocus <sup>2</sup>	Exposure mode		Metering			
		P S	A M	☒		☒ ☐	☐ <sup>*</sup>
				3D- RGB	RGB		
Type G, E, or D <sup>3</sup> ; AF-S, AF-P, AF-I	✓	✓	✓	✓	—	✓ <sup>4</sup>	✓
PC NIKKOR 19mm f/4E ED <sup>5</sup>	—	✓ <sup>6</sup>	✓ <sup>6</sup>	✓ <sup>6</sup>	—	✓ <sup>4,6</sup>	✓ <sup>6</sup>
PC-E NIKKOR series <sup>5</sup>	—	✓ <sup>6</sup>	✓ <sup>6</sup>	✓ <sup>6</sup>	—	✓ <sup>4,6</sup>	✓ <sup>6</sup>
PC Micro 85mm f/2.8D <sup>5,7</sup>	—	—	✓ <sup>8</sup>	✓ <sup>6</sup>	—	✓ <sup>4,6</sup>	✓ <sup>6</sup>
AF-S/AF-I Teleconverter <sup>9</sup>	✓	✓	✓	✓	—	✓ <sup>4</sup>	✓
Other AF NIKKOR (except lenses for F3AF)	✓ <sup>10</sup>	✓	✓	—	✓	✓ <sup>4</sup>	—
AI-P NIKKOR	—	✓	✓	—	✓	✓ <sup>4</sup>	—

- 1 IX-NIKKOR lenses cannot be used.
  - 2 **M** (manual focus) is available with all lenses.
  - 3 Vibration reduction (VR) is supported with VR lenses.
  - 4 [**Spot metering**] meters the selected focus point.
  - 5 Fog, lines, and other image artifacts (“noise”) may appear in photos taken with the electronic front-curtain shutter. This can be prevented by selecting [**Disable**] for Custom Setting d6 [**Electronic front-curtain shutter**].
  - 6 Cannot be used with shifting or tilting.
  - 7 The camera’s exposure metering and flash control systems will not function as expected when the lens is shifted and/or tilted, or when an aperture other than the maximum aperture is used.
  - 8 Mode **M** (manual) only.
  - 9 For information on the focus points available for autofocus and electronic rangefinding, see “AF-S/AF-I Teleconverters and Available Focus Points” (📖 1042).
  - 10 When an AF 80–200mm f/2.8, AF 35–70mm f/2.8, AF 28–85mm f/3.5–4.5 <New>, or AF 28–85mm f/3.5–4.5 lens is focused at the minimum distance at maximum zoom, the in-focus indicator may be displayed when the image on the matte screen in the viewfinder is not in focus. Adjust focus manually until the image in the viewfinder is in focus.
- “Noise” in the form of lines may appear during autofocus at high ISO sensitivities. Use manual focus or focus lock. Lines may also appear at high ISO sensitivities when aperture is adjusted during movie recording or live view photography.

---

## ✔ Lens f-Number

The f-number is a measure of lens “speed”, its maximum (widest) aperture. It appears at the end of the lens name, for example as “f/2.8” or “f/3.5–5.6”.

## ✔ VR Lenses

The lenses listed below are not recommended for long exposures or photographs taken at high ISO sensitivities, as due to the design of the vibration reduction (VR) control system the resulting photos may be marred by fog.

- AF-S VR Zoom-Nikkor 24–120mm f/3.5–5.6G IF-ED
- AF-S VR Zoom-Nikkor 70–200mm f/2.8G IF-ED
- AF-S VR Zoom-Nikkor 70–300mm f/4.5–5.6G IF-ED
- AF-S VR Nikkor 200mm f/2G IF-ED
- AF-S VR Nikkor 300mm f/2.8G IF-ED
- AF-S NIKKOR 16–35mm f/4G ED VR
- AF-S NIKKOR 24–120mm f/4G ED VR
- AF-S NIKKOR 28–300mm f/3.5–5.6G ED VR
- AF-S NIKKOR 400mm f/2.8G ED VR
- AF-S NIKKOR 500mm f/4G ED VR
- AF-S DX VR Zoom-Nikkor 18–200mm f/3.5–5.6G IF-ED
- AF-S DX NIKKOR 16–85mm f/3.5–5.6G ED VR
- AF-S DX NIKKOR 18–200mm f/3.5–5.6G ED VR II
- AF-S DX Micro NIKKOR 85mm f/3.5G ED VR
- AF-S DX NIKKOR 55–300mm f/4.5–5.6G ED VR

We recommend turning vibration reduction off when using other VR lenses.

## ✓ Calculating Angle of View

The camera can be used with Nikon lenses for 35 mm format cameras. If a 35 mm format lens or a lens that supports the FX format is attached, the angle of view will be the same as a frame of 35 mm film.

- You can also take pictures at angles of view that differ from that of the current lens by selecting different options for **[Image area] > [Choose image area]** in the photo shooting menu. For example, if a 35 mm format lens or a lens that supports the FX format is attached, you can reduce the angle of view by selecting **[DX (24×16)]**.

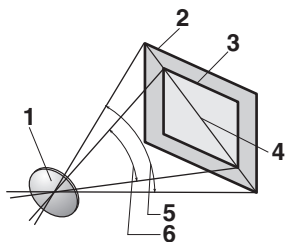

1	Lens
2	<b>[FX (36×24)]</b> picture size (35.9 × 23.9 mm, equivalent to 35 mm format camera)
3	<b>[DX (24×16)]</b> picture size (23.5 × 15.7 mm)
4	Picture diagonal
5	<b>[FX (36×24)]</b> angle of view (35 mm format)
6	<b>[DX (24×16)]</b> angle of view

- The picture diagonal for 35 mm format is about 1.5 times that of the **[DX (24×16)]** crop. Selecting **[DX (24×16)]** therefore multiplies the apparent focal length of 35 mm format lenses attached to the camera by about 1.5×. For example, selecting **[DX (24×16)]** when a lens with a focal length of 50 mm is attached increases the apparent focal length to about 75 mm.

## ✔ Cross Sensors

The availability of cross-sensor focus points varies with the lens used.

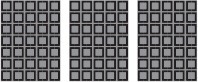
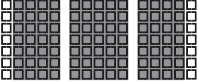
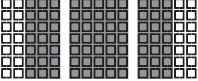
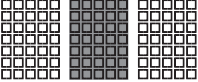
Lens	Cross sensors (cross-sensor focus points highlighted in gray <sup>2)</sup> )
AF-S and AF-P lenses other than those listed below with maximum apertures of f/4 or faster <sup>1</sup>	 <p>105 cross sensors</p>
<ul style="list-style-type: none"><li>• AF-S DX Zoom-Nikkor 12–24mm f/4G IF-ED</li><li>• AF-S NIKKOR 500mm f/4E FL ED VR</li><li>• AF-S NIKKOR 600mm f/4G ED VR</li><li>• AF-S NIKKOR 600mm f/4E FL ED VR</li><li>• AF-S Nikkor 600mm f/4D IF-ED II</li><li>• AF-S Nikkor 600mm f/4D IF-ED</li></ul>	 <p>91 cross sensors</p>
<ul style="list-style-type: none"><li>• AF-S NIKKOR 500mm f/4G ED VR</li><li>• AF-S Nikkor 500mm f/4D IF-ED II</li><li>• AF-S Nikkor 500mm f/4D IF-ED</li></ul>	 <p>77 cross sensors</p>
<ul style="list-style-type: none"><li>• AF-S NIKKOR 200–400mm f/4G ED VR II</li><li>• AF-S VR Zoom-Nikkor 200–400mm f/4G IF-ED</li><li>• AF-S and AF-P lenses with maximum apertures slower than f/4<sup>1</sup></li><li>• Non-AF-S, non-AF-P lenses</li></ul>	 <p>35 cross sensors</p>

1 At maximum zoom, in the case of zoom lenses.

2 Other focus points use line sensors, which detect horizontal lines.

## ✔ AF-S/AF-I Teleconverters and Available Focus Points

When an AF-S or AF-I teleconverter is attached, the focus points shown in the illustrations can be used during viewfinder photography for autofocus and electronic rangefinding (note that at maximum combined apertures slower than  $f/5.6$ , the camera may not be able to focus on dark or low-contrast subjects).

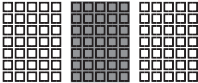
Teleconverter	Max. lens aperture <sup>1</sup>	Available focus points (cross-sensor focus points highlighted in gray <sup>2</sup> )
TC-14E, TC-14E II, TC-14E III TC-17E II TC-20E, TC-20E II, TC-20E III	$f/2$	
TC-14E, TC-14E II, TC-14E III	$f/2.8$	<ul style="list-style-type: none"><li>• 105 focus points</li><li>• 105 cross sensors</li></ul>
TC-17E II TC-20E, TC-20E II, TC-20E III	$f/2.8$	
TC-14E, TC-14E II, TC-14E III	$f/4$	<ul style="list-style-type: none"><li>• 105 focus points</li><li>• 35 cross sensors</li></ul>

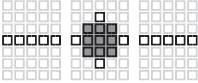
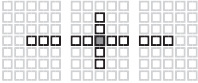
Teleconverter	Max. lens aperture <sup>1</sup>	Available focus points (cross-sensor focus points highlighted in gray <sup>2</sup> )
TC-17E II	f/4	 <ul style="list-style-type: none"> <li>• 23 focus points</li> <li>• 9 cross sensors</li> </ul>
TC-800-1.25E ED	f/5.6	
TC-20E, TC-20E II, TC-20E III	f/4	 <ul style="list-style-type: none"> <li>• 15 focus points</li> <li>• 1 cross sensor</li> </ul>
TC-14E, TC-14E II, TC-14E III	f/5.6	

1 At maximum zoom, in the case of zoom lenses.

2 Other focus points use line sensors, which detect horizontal lines.

Autofocus is not available when teleconverters are used with AF-S VR Micro-Nikkor 105mm f/2.8G IF-ED lenses.

---

## ✔ Recognizing CPU and Type G, E, and D Lenses

CPU lenses can be identified by the presence of CPU contacts (①). Type G lenses are marked with a “G”, type E lenses with an “E”, and type D lenses with a “D”. Type G and E lenses are not equipped with a lens aperture ring (②).

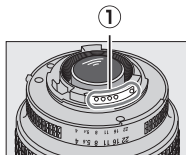

CPU lens

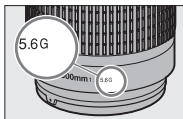

Type G or E lens

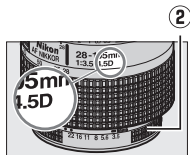

Type D lens



## Non-CPU lenses and Other Accessories

Lens <sup>1</sup> /accessory	Exposure mode		Metering			
	P S	A M	☒		☒	☒ <sup>*</sup>
			3D- RGB	RGB	☒	☒
AI-, AI-modified NIKKOR or Nikon Series E lenses <sup>2</sup>	—	✓ <sup>3</sup>	—	✓ <sup>4</sup>	✓ <sup>5</sup>	—
Medical-NIKKOR 120mm f/4	—	✓ <sup>6</sup>	—	—	—	—
Reflex-NIKKOR	—	✓ <sup>3</sup>	—	—	✓ <sup>5</sup>	—
PC-NIKKOR	—	✓ <sup>7</sup>	—	—	✓	—
AI-type Teleconverter <sup>8</sup>	—	✓ <sup>3</sup>	—	✓ <sup>4</sup>	✓ <sup>5</sup>	—
PB-6 Bellows Focusing Attachment <sup>9</sup>	—	✓ <sup>10</sup>	—	—	✓	—
Auto extension rings (PK-series 11A, 12, or 13; PN-11)	—	✓ <sup>3</sup>	—	—	✓	—

- 1 Some lenses cannot be used (☒ 1047).
- 2 The range of rotation for the AI 80–200mm f/2.8 ED tripod mount is limited by the camera body. Filters cannot be exchanged while an AI 200–400mm f/4 ED is mounted on camera.
- 3 If the maximum aperture is specified using the **[Non-CPU lens data]** item in the setup menu, the aperture value will be displayed in the viewfinder and control panel.

- 4 Can be used only if the lens focal length and maximum aperture are specified using the [**Non-CPU lens data**] item in the setup menu. Some lenses may, however, fail to produce the desired results even if the focal length and maximum aperture are supplied. Use [**Spot metering**] or [**Center-weighted metering**] if the desired results are not achieved.
  - 5 For improved precision, specify the lens focal length and maximum aperture using the [**Non-CPU lens data**] item in the setup menu.
  - 6 Can be used in mode **M** at shutter speeds one step or more slower than the flash sync speed.
  - 7 Use stop-down metering. In mode **A**, stop aperture down using the controls on the lens and lock exposure before shifting the lens. In mode **M**, stop aperture down using the controls on the lens and meter exposure before shifting the lens.
  - 8 Exposure compensation required with AI 28–85mm f/3.5–4.5, AI 35–105mm f/3.5–4.5, AI 35–135mm f/3.5–4.5, or AF-S 80–200mm f/2.8D lenses.
  - 9 Requires a PK-12 or PK-13 auto extension ring. A PB-6D may be required depending on camera orientation.
  - 10 Can be used with stop-down metering; in mode **A**, stop aperture down using the controls on the bellows attachment and meter exposure before taking photographs.
- Lines may appear at high ISO sensitivities when aperture is adjusted during movie recording or live view photography.

---

## ✓ Incompatible Lenses and Accessories

The following non-CPU lenses and accessories cannot be used. Attempting to mount them on the camera could damage the camera or lens.

- TC-16A AF teleconverters
  - Non-AI lenses (lenses with pre-AI exposure couplings)
  - Lenses that require the AU-1 focusing unit (400mm f/4.5, 600mm f/5.6, 800mm f/8, 1200mm f/11)
  - Fisheye (6mm f/5.6, 7.5mm f/5.6, 8mm f/8, OP 10mm f/5.6)
  - 2.1cm f/4
  - K2 extension rings
  - 180–600mm f/8 ED lenses (serial numbers 174041–174180)
  - 360–1200mm f/11 ED lenses (serial numbers 174031–174127)
  - 200–600mm f/9.5 lenses (serial numbers 280001–300490)
  - AF lenses for the F3AF (AF 80mm f/2.8, AF 200mm f/3.5 ED, TC-16 AF teleconverters)
  - PC 28mm f/4 lenses (serial numbers 180900 or earlier)
  - PC 35mm f/2.8 lenses (serial numbers 851001–906200)
  - PC 35mm f/3.5 lenses (old type)
  - Reflex 1000mm f/6.3 lenses (old type)
  - Reflex 1000mm f/11 lenses (serial numbers 142361–143000)
  - Reflex 2000mm f/11 lenses (serial numbers 200111–200310)
-

---

### **Compatible Non-CPU Lenses**

- Specifying the lens focal length and maximum aperture using the [**Non-CPU lens data**] item in the setup menu allows many of the features available with CPU lenses, including aperture value display and color matrix metering, to be used with non-CPU lenses. If the focal length and maximum aperture are not provided and [**Matrix metering**] is selected for metering, [**Center-weighted metering**] will be used instead.
  - Aperture must be set using the lens aperture ring. If the maximum aperture is not provided using [**Non-CPU lens data**], the aperture displays in the camera top control panel and viewfinder will show the number of stops from maximum aperture and the actual aperture value must be read off the lens aperture ring.
-

# The Electronic Rangefinder

The conditions under which the electronic rangefinder can be used vary with the lens.

## ■ CPU lenses

Lens/accessory	Viewfinder photography	Live view
Type G, E, or D; AF-S, AF-P, AF-I	✓	—
PC NIKKOR 19mm f/4E ED	✓ <sup>1</sup>	—
PC-E NIKKOR series	✓ <sup>1</sup>	—
PC Micro 85mm f/2.8D	✓ <sup>1</sup>	—
AF-S/AF-I Teleconverter	✓	—
Other AF NIKKOR (except lenses for F3AF)	✓ <sup>2</sup>	—
AI-P NIKKOR	✓ <sup>3</sup>	—

- 1 Cannot be used with shifting or tilting.
- 2 When an AF 80–200mm f/2.8, AF 35–70mm f/2.8, AF 28–85mm f/3.5–4.5 <New>, or AF 28–85mm f/3.5–4.5 lens is focused at the minimum distance at maximum zoom, the in-focus indicator may be displayed when the image on the matte screen in the viewfinder is not in focus. Adjust focus manually until the image in the viewfinder is in focus.
- 3 With a maximum aperture of f/5.6 or faster.

## ■ Non-CPU Lenses and Other Accessories

Lens/accessory	Viewfinder photography	Live view
AI-, AI-modified NIKKOR or Nikon Series E lenses	✓ <sup>1</sup>	—
Medical-NIKKOR 120mm f/4	✓	—
Reflex-NIKKOR	—	—
PC-NIKKOR	✓ <sup>2</sup>	—
AI-type Teleconverter	✓ <sup>3</sup>	—
PB-6 Bellows Focusing Attachment	✓ <sup>3</sup>	—
Auto extension rings (PK-series 11A, 12, or 13; PN-11)	✓ <sup>3</sup>	—

- 1 With a maximum aperture of f/5.6 or faster.
- 2 Cannot be used with shifting or tilting.
- 3 With a maximum effective aperture of f/5.6 or faster.



## Compatible Flash Units

### The Nikon Creative Lighting System (CLS)

Nikon's advanced Creative Lighting System (CLS) supports a variety of features thanks to improved communication between the camera and compatible flash units.





#### ■ Features Available with CLS-Compatible Flash Units

Supported features			Flash unit								
			SB-5000	SB-800	SB-910/ SB-900/ SB-800	SB-700	SB-600	SB-500	SU-800	SB-R200	SB-400
Single flash	i-TTL	i-TTL balanced fill-flash for digital SLR <sup>1</sup>	✓	✓	✓	✓	✓	—	—	✓	✓
		Standard i-TTL fill-flash for digital SLR	✓ <sup>2</sup>	✓ <sup>2</sup>	✓	✓ <sup>2</sup>	✓	—	—	✓	✓
	 <b>A</b>	Auto aperture	✓	✓ <sup>3</sup>	—	—	—	—	—	—	—
	<b>A</b>	Non-TTL auto	—	✓ <sup>3</sup>	—	—	—	—	—	—	—
	<b>GN</b>	Distance-priority manual	✓	✓	✓	—	—	—	—	—	—
	<b>M</b>	Manual	✓	✓	✓	✓	✓ <sup>4</sup>	—	—	✓ <sup>4</sup>	✓ <sup>4</sup>
	<b>RPT</b>	Repeating flash	✓	✓	—	—	—	—	—	—	—

Supported features		Flash unit									
		SB-5000	SB-800	SB-910/ SB-900/ SB-800	SB-700	SB-600	SB-500	SU-800	SB-R200	SB-400	SB-300
Master	Remote flash control	✓	✓	✓	—	✓ <sup>4</sup>	✓	—	—	—	—
	<b>i-TTL</b> i-TTL	✓	✓	✓	—	✓ <sup>4</sup>	—	—	—	—	
	<b>[A : B]</b> Quick wireless flash control	✓	—	✓	—	—	—	✓ <sup>5</sup>	—	—	
	 <b>A</b> Auto aperture	✓	✓	—	—	—	—	—	—	—	
	<b>A</b> Non-TTL auto	—	—	—	—	—	—	—	—	—	
	<b>M</b> Manual	✓	✓	✓	—	✓ <sup>4</sup>	—	—	—	—	
	<b>RPT</b> Repeating flash	✓	✓	—	—	—	—	—	—	—	
	<b>i-TTL</b> i-TTL	✓	✓	✓	✓	✓	—	✓	—	—	
	<b>[A : B]</b> Quick wireless flash control	✓	✓	✓	✓	✓	—	✓	—	—	
	 <b>A/A</b> Auto aperture/non-TTL auto	✓ <sup>6</sup>	✓ <sup>6</sup>	—	—	—	—	—	—	—	
Remote	<b>M</b> Manual	✓	✓	✓	✓	✓	—	✓	—	—	
	<b>RPT</b> Repeating flash	✓	✓	✓	✓	✓	—	—	—	—	



Supported features	Flash unit									
	SB-5000	SB-900/ SB-800	SB-910/ SB-900/ SB-800	SB-700	SB-600	SB-500	SU-800	SB-R200	SB-400	SB-300
Radio-controlled Advanced Wireless Lighting	✓ <sup>7</sup>	—	—	—	—	—	—	—	—	—
Color Information Communication (flash)	✓	✓	✓	✓	✓	—	—	✓	✓	
Color Information Communication (LED light)	—	—	—	—	✓	—	—	—	—	
Auto FP high-speed sync <sup>8</sup>	✓	✓	✓	✓	✓	✓	✓	—	—	
FV lock <sup>9</sup>	✓	✓	✓	✓	✓	✓	✓	✓	✓	
Red-eye reduction	✓	✓	✓	✓	✓	—	—	✓	—	
Camera modeling illumination	✓	✓	✓	✓	✓	✓	✓	—	—	
Unified flash control	✓	—	—	—	✓	—	—	✓	✓	
Camera flash unit firmware update	✓	✓ <sup>10</sup>	✓	—	✓	—	—	—	✓	

- 1 Not available with spot metering.
- 2 Can also be selected via the flash unit.
- 3 A/A mode selection is performed on the flash unit using custom settings.
- 4 Can be selected using the [**Flash control**] item in the camera menus.
- 5 Available during close-up photography only.
- 6 Choice of A and A depends on the option selected with the master flash.
- 7 Supports the same features as remote flash units with optical AWL.
- 8 Available only in i-TTL, A, A, GN, and M flash-control modes.
- 9 Available only in i-TTL flash control mode or when the flash is configured to emit monitor preflashes in A or A flash control mode.
- 10 Firmware updates for the SB-910 and SB-900 can be performed from the camera.

## ■ The SU-800 Wireless Speedlight Commander

When mounted on a CLS-compatible camera, the SU-800 can be used as a commander for SB-5000, SB-910, SB-900, SB-800, SB-700, SB-600, SB-500, or SB-R200 flash units. Group flash control is supported for up to three groups. The SU-800 itself is not equipped with a flash.

### ✓ Other Flash Units

The following flash units can be used in non-TTL auto (**A**) and manual modes. The options available do not vary with the lens used.

Supported features		Flash unit					
		SB-80DX SB-28DX	SB-50DX	SB-28 SB-26 SB-25 SB-24	SB-30 SB-27 <sup>1</sup> SB-22S SB-22 SB-20 SB-16B SB-15	SB-23 SB-29 SB-21B SB-29S	
Flash mode	<b>A</b>	Non-TTL auto	✓	—	✓	✓	—
	<b>M</b>	Manual	✓	✓	✓	✓	✓
		Repeating flash	✓	—	✓	—	—
	<b>REAR</b> <sup>2</sup>	Rear-curtain sync	✓	✓	✓	✓	✓

- 1 Mounting an SB-27 on the camera automatically sets the flash mode to **TTL**, but setting the flash mode to **TTL** disables the shutter release. Set the SB-27 to **A**.
- 2 Available when the camera is used to select the flash mode.

## ✔ Metering Areas for FV Lock

The areas metered when FV lock is used with optional flash units are as follows:

Picture taken with	Flash control mode	Metered area
Stand-alone flash unit	i-TTL	6-mm circle in center of frame
	Auto aperture (⊗A)	Area metered by flash exposure meter
Remote flash units controlled via Advanced Wireless Lighting	i-TTL	Entire frame
	Auto aperture (⊗A)	Area metered by flash exposure meter
	Non-TTL auto (A)	

## ✔ Notes on Optional Flash Units

- Refer to the flash unit manual for detailed instructions.
- If the unit supports CLS, refer to the section on CLS-compatible digital SLR cameras. This camera is not included in the “digital SLR” category in the SB-80DX, SB-28DX, and SB-50DX manuals.
- If the flash-ready indicator (⚡) flashes for about three seconds after a photograph is taken in i-TTL or non-TTL auto mode, the flash has fired at full power and the photograph may be underexposed (CLS-compatible flash units only).
- i-TTL flash control can be used at ISO sensitivities between 100 and 12800.

- At ISO sensitivities over 12800, the desired results may not be achieved at some ranges or aperture settings.
- In mode **P**, the maximum aperture (minimum f-number) is limited according to ISO sensitivity, as shown below:

<b>Maximum aperture (f-number) at ISO equivalent of:</b>							
<b>100</b>	<b>200</b>	<b>400</b>	<b>800</b>	<b>1600</b>	<b>3200</b>	<b>6400</b>	<b>12800</b>
4	5	5.6	7.1	8	10	11	13

- \* If the maximum aperture of the lens is smaller than given above, the maximum value for aperture will be the maximum aperture of the lens.
- The SB-5000, SB-910, SB-900, SB-800, SB-700, SB-600, SB-500, and SB-400 provide red-eye reduction in red-eye reduction and slow-sync with red-eye reduction flash modes.
- "Noise" in the form of lines may appear in flash photographs taken with an SD-9 or SD-8A high-performance battery pack attached directly to the camera. Reduce ISO sensitivity or increase the distance between the camera and the battery pack.
- The SB-5000, SB-910, SB-900, SB-800, SB-700, SB-600, and SU-800 provide AF-assist illumination as required.

- During viewfinder photography, the focus points for which AF illumination is available vary with focal length.

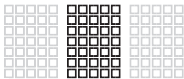
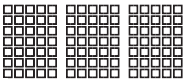
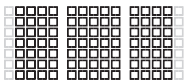
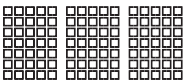
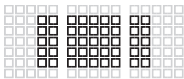
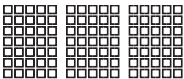
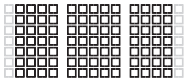
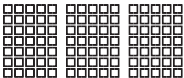
<b>Flash unit</b>	<b>Examples of focus points for which AF-assist illumination is available</b>	
<b>SB-5000</b>	<b>Focal length 24 mm</b>	<b>Focal length 135 mm</b>
		
<b>SB-910/ SB-900</b>	<b>Focal length 17 mm</b>	<b>Focal length 135 mm</b>
		
<b>SB-800/ SB-600/ SU-800 wireless speedlight commander</b>	<b>Focal length 24 mm</b>	<b>Focal length 105 mm</b>
		
<b>SB-700</b>	<b>Focal length 24 mm</b>	<b>Focal length 135 mm</b>
		

- Depending on the lens used and scene recorded, the in-focus indicator (●) may be displayed when the subject is not in focus, or the camera may be unable to focus and the shutter release will be disabled.

- When an SC-series 17, 28, or 29 sync cable is used for off-camera flash photography, correct exposure may not be achieved in i-TTL mode. We recommend that you select standard i-TTL fill-flash. Take a test shot and view the results in the monitor.
- In i-TTL, do not use any form of flash panel (diffusion panel) other than the flash unit's built-in flash panel or bounce adapters provided with the flash unit. Using other panels may produce incorrect exposure.

### ✔ **Flash Compensation for Optional Flash Units**

In i-TTL and auto aperture (A) flash control modes, the flash compensation selected with the optional flash unit or the **[Flash control]** item in the photo shooting menu is added to the flash compensation selected with the  button.

---

### ✔ **Modeling Illumination**

- Optional CLS-compatible flash units emit a modeling flash when the camera **Pv** button is pressed.
  - This feature can be used with Advanced Wireless Lighting to preview the total lighting effect achieved with multiple flash units.
  - Modeling illumination can be turned off by selecting **[Off]** for Custom Setting e6 **[Modeling flash]**.
-

## Other Compatible Accessories

A variety of accessories are available for your Nikon camera.

### ● Power Sources

- **EN-EL18c Rechargeable Li-ion Battery:** EN-EL18c batteries can be used with Nikon D6 digital cameras. EN-EL18c batteries can be charged and calibrated using MH-26a battery chargers.
  - EN-EL18b/EN-EL18a/EN-EL18 batteries can also be used. Note, however, that fewer pictures can be taken on a single charge with an EN-EL18 than with an EN-EL18c/EN-EL18b/EN-EL18a (☐ 1125).
- **MH-26a Battery Charger:** The MH-26a can be used to recharge EN-EL18c/EN-EL18b/EN-EL18a/EN-EL18 batteries. The MH-26a can also be used to calibrate batteries.
  - MH-26 battery chargers can be used in place of the MH-26a.
- **EP-6 Power Connector, EH-6c AC Adapter:** Use AC adapters to power the camera for extended periods.
  - The EP-6 is needed to connect the EH-6c to the camera. See “Attaching a Power Connector and AC Adapter” (☐ 1069) for details.
  - EH-6b, EH-6a, and EH-6 AC adapters can be used in place of the EH-6c.



## ● Accessory Shoe Covers

**BS-3/BS-1 Accessory Shoe Covers:** Accessory shoe covers protect the accessory shoe when no flash unit is attached (☐ 1066).

## ● Body Caps

**BF-1B Body Cap/BF-1A Body Cap:** Body caps prevent dust entering the camera when no lens is in place.

## ● Viewfinder Eyepiece Accessories

- **DK-19 Rubber Eyecup:** A rubber eyecup that can be fitted to the camera viewfinder. The DK-19 makes the image in the viewfinder easier to see, preventing eye fatigue.
- **DK-17C Diopter-Adjustment Viewfinder Lenses:** These lenses can be dropped into the viewfinder eyepiece to accommodate the needs of far- and near-sighted photographers. Choose from lenses with diopters of  $-3$ ,  $-2$ ,  $0$ ,  $+1$ , and  $+2 \text{ m}^{-1}$ . Be sure to try the lenses in the store before purchase, as results can vary widely from person to person. Diopter adjustment lenses (☐ 1067) can be used for diopters beyond the range of the camera's diopter adjustment control ( $-3$  to  $+1 \text{ m}^{-1}$ ).
- **DK-17M Magnifying Eyepiece:** When fitted to the camera viewfinder, the DK-17M increases magnification by approximately  $1.2\times$ .
- **DG-2 Eyepiece Magnifier:** The DG-2 magnifies the scene at the center of the viewfinder. Use it in situations requiring especially precise focus.
- **DK-18 Eyepiece Adapter:** An adapter used when attaching DG-2 magnifiers or DR-3 right-angle viewing attachments (☐ 1067).
- **DK-27 Eyepiece Adapter:** A DK-27 is supplied with the camera.
- **DK-14/DK-17A Antifog Finder Eyepieces:** These viewfinder eyepieces prevent fogging in humid or cold conditions.

- **DK-17F Fluorine-Coated Finder Eyepiece:** A DK-17F is supplied with the camera. The protective glass features Nikon's unique, easy-to-clean fluorine coating on both surfaces.
- **DR-5 Right-Angle Viewing Attachment:** The DR-5 attaches to the viewfinder eyepiece at a right angle, allowing the image in the viewfinder to be viewed from above when the camera is used to take pictures in "wide" (landscape) orientation. Choose from magnifications of 1× and 2× \*, the former to view the entire frame and the latter for greater precision when focusing. Diopter adjustment is also supported.
  - \* The edges of the frame are not visible when the view is magnified.
- **DR-4 Right-Angle Viewing Attachment:** The DR-4 attaches to the viewfinder eyepiece at a right angle, allowing the image in the viewfinder to be viewed from above when the camera is used to take pictures in "wide" (landscape) orientation.

### ● Filters

- Neutral Color (NC) filters can be used to protect the lens.
- The camera cannot be used with linear polarizing filters. Use the C-PL or C-PLII circular polarizing filter instead.
- Filters may cause ghosting when the subject is framed against a bright light, or when a bright light source is in the frame. Filters can be removed if ghosting occurs.
- RGB and 3D-RGB matrix metering may not produce the desired results with filters with exposure factors (filter factors) over 1× (Y44, Y48, Y52, O56, R60, X0, X1, C-PL, ND2S, ND4, ND4S, ND8, ND8S, ND400, A2, A12, B2, B8, B12); we suggest that [**Center-weighted metering**] be selected instead. See the filter manual for details.
- Filters intended for special-effects photography may interfere with autofocus or the electronic rangefinder.

## ● **Wireless Transmitters** <sup>1,2</sup>

**WT-6 Wireless Transmitters:** Use a wireless transmitter to upload pictures over a wireless network or control the camera from a computer running Camera Control Pro 2 (available separately). You can also take and browse pictures remotely from a computer or smart device.

- 1 Requires a wireless network and some basic network knowledge. Be sure to update the wireless transmitter software to the latest version.
- 2 WT-5 wireless transmitters cannot be used.

## ● **Wireless Remote Controllers**

• **WR-R10/WR-T10 Wireless Remote Controllers:** When a WR-R10 is connected to the ten-pin remote terminal using a WR-A10 adapter, the camera can be controlled remotely using a WR-T10 wireless remote controller.

- The WR-R10 can also be used to control radio-controlled flash units.
- For synchronized release involving more than one camera, ready multiple cameras with paired WR-R10 units attached.

• **WR-1 Wireless Remote Controller:** WR-1 units are used with WR-R10 or WR-T10 wireless remote controllers or with other WR-1 remote controllers, with the WR-1 units functioning as either transmitters or receivers. When a WR-R10 or a WR-1 configured as a receiver is connected to the ten-pin remote terminal, a WR-T10 or a second WR-1 configured as a transmitter can be used to take pictures remotely. Camera settings can also be adjusted using a WR-1 configured as a transmitter.

\* Be sure the firmware for the WR-R10 and WR-1 has been updated to the latest versions (WR-R10 firmware version 3.0 or later and WR-1 firmware version 1.0.1 or later). For information on firmware updates, see the Nikon website for your area. Consult a Nikon-authorized service representative when updating the firmware for the WR-R10 from versions prior to version 2.0 to version 3.0 or later.

## ● Remote Terminal Accessories

The camera is equipped with a ten-pin remote terminal for remote control and automatic photography.

Be sure to replace the terminal cap when the terminal is not in use. Dust or other foreign matter accumulating in the terminal contacts could cause the camera to malfunction.

- **MC-22/MC-22A Remote Cords (length approximately 1 m/3.3 ft):** Remote shutter releases with blue, yellow, and black terminals for connection to remote shutter-triggering devices, allowing control via sound or electronic signals.
- **MC-30/MC-30A Remote Cords (length approximately 80 cm/2.7 ft):** Remote shutter releases; can be used to reduce camera shake.
- **MC-36/MC-36A Remote Cords (length approximately 85 cm/2.8 ft):** Remote shutter releases with timers for interval-timer photography.
- **MC-21/MC-21A Extension Cords (length approximately 3 m/9.9 ft):** Can be connected to ML-3 or MC-series 20, 22, 22A, 23, 23A, 25, 25A, 30, 30A, 36, or 36A, but note that two or more extensions cords cannot be connected together.
- **MC-23/MC-23A Connecting Cords (length approximately 40 cm/1.4 ft):** Use an MC-23 or 23A to connect two cameras via their ten-pin terminals for simultaneous operation.
- **MC-25/MC-25A Adapter Cords (length approximately 20 cm/7.9 in.):** Ten-pin to two-pin adapter cords for connection to devices with two-pin terminals, including the MW-2 radio control set, MT-2 intervalometer, and ML-2 modulite control set.
- **WR-A10 WR Adapter:** An adapter used to connect WR-R10 wireless remote controllers to cameras with ten-pin remote terminals.
- **ML-3 Modulite Remote Control Set:** Allows infrared remote control at ranges of up to 8 m (26.2 ft).

## ● **USB Cables**

- **UC-E24 USB Cable:** A USB cable with a type C connector for connection to the camera and a type A connector for connection to the USB device.
- **UC-E25 USB Cable:** A USB cable with two type C connectors.

## ● **HDMI Cables**

**HC-E1 HDMI Cable:** An HDMI cable with a type C connector for connection to the camera and a type A connector for connection to HDMI devices.

## ● **Microphones**

- **ME-1 Stereo Microphone:** Connect the ME-1 to the camera microphone jack to record stereo sound. Using an external microphone also reduces the chance of picking up equipment noise, such as the sounds produced by the lens during autofocus.
- **ME-W1 Wireless Microphone:** A wireless Bluetooth microphone. Use the ME-W1 for off-camera recording.

## ● **Connector Covers**

**UF-6 Connector Cover for Stereo Mini-Plug Cables:** Prevents accidental disconnection of mini-plug cables for optional ME-1 stereo microphones.

---

### ✔ Compatible Accessories

- Availability may vary with country or region.
- See our website or brochures for the latest information.

### ✔ The BS-3 Accessory Shoe Cover

The supplied accessory shoe cover can be used to protect the accessory shoe or to prevent light reflected from the metal parts of the shoe appearing in photographs. The cover slides into the shoe as shown. To remove the cover, hold the camera firmly, press the cover down with a thumb and slide it in the direction shown.

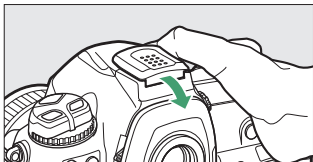
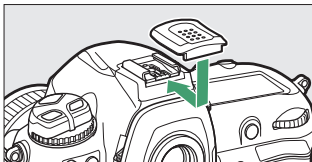

### ✓ Attaching Diopter-Adjustment Viewfinder Lenses

Remove the DK-17F viewfinder eyepiece before attaching a diopter-adjustment viewfinder lens. Press the latches on both sides of the eyepiece adapter simultaneously to release the eyepiece lock (①) and then unscrew the eyepiece as shown (②).

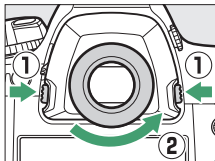

### ✓ Removing the Eyepiece Adapter

Press and lift the latches on both sides simultaneously (①) and remove the adapter as shown (②).

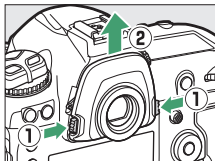

## ✔ The HDMI/USB Cable Clip

To prevent accidental disconnection, attach the supplied clip to HDMI cables or to the supplied USB cable as shown (note that the clip may not fit all third-party HDMI cables). The illustrations show the USB cable.

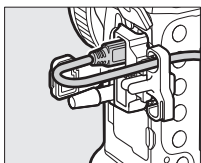
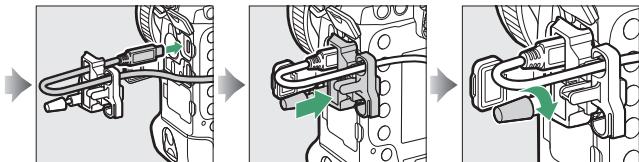
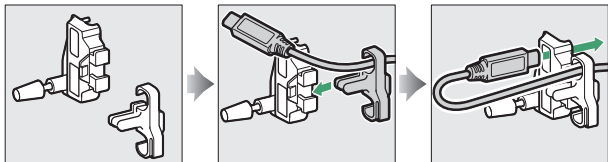

USB cable

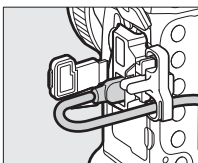

HDMI cable

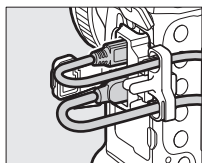

HDMI cable and USB  
cable used  
simultaneously



## **Attaching a Power Connector and AC Adapter**

Turn the camera off before attaching an optional power connector and AC adapter.

### **1 Remove the BL-6 battery-chamber cover.**

Lift the battery-chamber cover latch, turn it to the open (⊞) position (①), and remove the BL-6 battery-chamber cover (②).

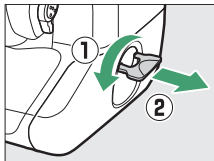

### **2 Connect the EH-6c AC adapter to the EP-6 power connector.**

- Pass the DC cable over the power connector cable guide (①) and slide it down until it is at the bottom of the slot.

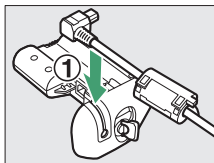

- Insert the DC plug into the DC IN connector (②).

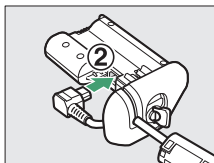

### 3 Insert the power connector.

Fully insert the power connector into the battery chamber as shown.

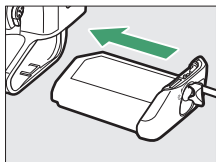

### 4 Latch the power connector.

- Rotate the latch to the closed position (①) and fold it down as shown (②).

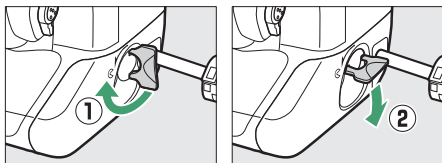

- To prevent the power connector being dislodged during operation, be sure that it is securely latched.
- The battery level is not displayed in the top control panel while the camera is powered by the AC adapter and power connector.

# Software

The following Nikon software can be used with the camera:

## ● Computer Software

Nikon computer software is available from the Nikon Download Center. Check the version and system requirements and be sure to download the latest version.

<https://downloadcenter.nikonimglib.com/>

- **Camera Control Pro 2** (available for purchase): Control the camera remotely from a computer and save photographs directly to the computer hard disk. A PC connection indicator (P ) will be displayed in the camera top control panel if Camera Control Pro 2 is launched while the camera is connected to the computer.
- **ViewNX-i** \*: More than a tool for viewing and editing photos and movies shot with Nikon digital cameras, ViewNX-i can be used in combination with other Nikon imaging applications to help you get the most from your pictures. It also offers smooth access to online services.
  - \* Existing users should be sure to download the latest version, as earlier versions may not support the camera.
- **Capture NX-D**: Fine-tune photos shot in Nikon's unique NEF/NRW (RAW) formats or convert them to JPEG or TIFF (NEF/RAW processing). Capture NX-D can be used not only with NEF/NRW (RAW) pictures but also with JPEG and TIFF photos shot with Nikon digital cameras for such tasks as editing tone curves and enhancing brightness and contrast.

- **Wireless Transmitter Utility:** The Wireless Transmitter Utility is required if the camera is to be connected to a network. Pair the camera with the computer and download pictures via Wi-Fi.

● **Smartphone (Tablet) Apps**

Smartphone apps can be downloaded from the Apple App Store® or on Google Play™. Visit the Nikon website for the latest information.

**SnapBridge:** Download photos and movies from the camera to your smart device via a wireless connection.

# Caring for the Camera

## **Storage**

When the camera will not be used for an extended period, remove the battery. Before removing the battery, confirm that the camera is off.

Do not store the camera in locations that:

- are poorly ventilated or subject to humidities of over 60%
- are next to equipment that produces strong electromagnetic fields, such as televisions or radios
- are exposed to temperatures above 50 °C (122 °F) or below –10 °C (14 °F)

## **Cleaning**

The procedure varies with the part that requires cleaning. The procedures are detailed below.

- Do not use alcohol, thinner, or other volatile chemicals.

## ■ Camera Body

Use a blower to remove dust and lint, then wipe gently with a soft, dry cloth. After using the camera at the beach or seaside, wipe off sand or salt with a cloth lightly dampened in distilled water and dry the camera thoroughly.

**Important:** *Dust or other foreign matter inside the camera may cause product malfunction. Damage due to the presence of foreign matter inside the camera is not covered under warranty.*

## ■ Lens, Mirror, and Viewfinder

These glass elements are easily damaged: remove dust and lint with a blower. If using an aerosol blower, keep the can vertical to prevent the discharge of liquid that could damage glass elements. To remove fingerprints and other stains, apply a small amount of lens cleaner to a soft cloth and clean with care.

## ■ Monitor

Remove dust and lint with a blower. When removing fingerprints and other stains, wipe the surface lightly with a soft cloth or chamois leather. Do not apply pressure, as this could result in damage or malfunction.

## The Low-Pass Filter

Dirt or dust entering the camera when lenses are exchanged or the body cap is removed may adhere to the low-pass filter and affect your photographs. The “clean image sensor” option vibrates the filter to remove dust.

The filter can be cleaned at any time from the menus, or cleaning can be performed automatically when the camera is turned on or off.

### ■ ■ Using the Menus

- For maximum effect, hold the camera in normal orientation (base down).

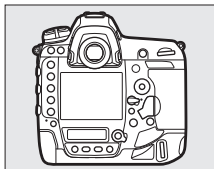

- Select [**Clean image sensor**] in the setup menu, then highlight [**Clean now**] and press **OK** to begin cleaning.

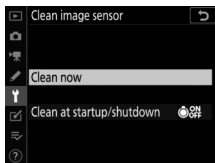

- Camera controls cannot be used while cleaning is in progress. Do not remove or disconnect the power source.
- The setup menu will be displayed when cleaning is complete.

## ■ Cleaning the Image Sensor at Startup and/or Shutdown

Option	Description
●ON [Clean at startup]	The image sensor is automatically cleaned each time the camera is turned on.
●OFF [Clean at shutdown]	The image sensor is automatically cleaned during shutdown each time the camera is turned off.
●ON OFF [Clean at startup & shutdown]	The image sensor is cleaned automatically at startup and at shutdown.
[Cleaning off]	Automatic image sensor cleaning off.

### 1 Select [Clean at startup/shutdown] for [Clean image sensor].

Pressing  when [Clean at startup/shutdown] is highlighted displays [Clean at startup/shutdown] options.

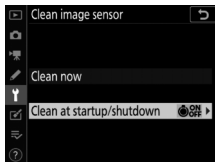

### 2 Highlight an option.

Press  to select the highlighted option.

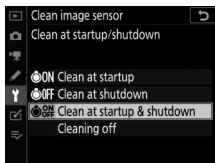



---

## ✓ Image Sensor Cleaning

- Using camera controls interrupts any image sensor cleaning begun in response to the operation of the power switch.
  - Image sensor cleaning may not fully remove all foreign matter from the filter. Clean the filter manually (📖 1078) or consult a Nikon-authorized service representative.
  - If image sensor cleaning is performed several times in succession, image sensor cleaning may be temporarily disabled to protect the camera's internal circuitry. Cleaning can be performed again after a short wait.
-

## Manual Cleaning

If foreign matter cannot be removed from the low-pass filter using the “clean image sensor” option (☰ 1075), the filter can be cleaned manually as described below. Note, however, that because the filter is extremely delicate and easily damaged, we recommend that manual cleaning be performed only by a Nikon-authorized service representative.

- To prevent loss of power during the operation, use a fully-charged battery or connect an optional AC adapter and power connector.
- Manual cleaning requires use of the [**Lock mirror up for cleaning**] item in the setup menu. The [**Lock mirror up for cleaning**] item is not available at battery levels of  or below or if the camera is connected to a smart device via Bluetooth or other devices via USB.

---

### 1 Turn the camera off and remove the lens.

After removing the lens, turn the camera on.

---

### 2 Highlight [**Lock mirror up for cleaning**] in the setup menu and press .

The camera will prepare to lock the mirror up.



---

### 3 Press **OK**.

- The mirror will be raised and the shutter curtain will open.
- The display in the top control panel will flash. The displays in the viewfinder and rear control panel will turn off.
- To restore normal operation without inspecting the low-pass filter, turn the camera off.

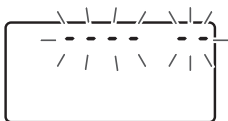

---

### 4 Holding the camera so that light can enter the camera, examine the filter for dust or lint.

If no foreign objects are present, proceed to Step 6.

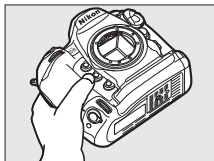

---

**5 Remove any dust and lint from the low-pass filter with a blower.**

- Do not use a blower-brush. The bristles could damage the filter.
- Dirt that cannot be removed with a blower can only be removed by Nikon-authorized service personnel. Under no circumstances should you touch or wipe the filter.

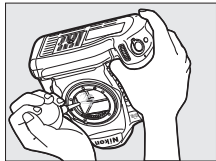

---

**6 Turn the camera off and replace the lens.**

The mirror will return to the down position and the shutter curtain will close.

---

### ✔ Use a Reliable Power Source

The shutter curtain is delicate and easily damaged. If the camera powers off while the mirror is raised, the curtain will close automatically. To prevent damage to the curtain caused by the shutter closing inadvertently during the operation, observe the following precautions:

- Do not turn the camera off while the mirror is raised.
- Do not remove or disconnect the power source while the mirror is raised.
- If the battery runs low while the mirror is raised, a beep will sound and the self-timer lamp will flash. The shutter curtain will close and the mirror will be lowered after about two minutes; end cleaning or inspection immediately.

### ✔ Foreign Matter on the Low-Pass Filter



Foreign matter entering the camera when lenses or body caps are removed or exchanged (or in rare circumstances lubricant or fine particles from the camera itself) may adhere to the low-pass filter, where it may appear in photographs taken under certain conditions. To prevent entry of foreign matter when attaching the body cap or exchanging lenses, avoid dusty environments and be sure to remove all dust and other foreign matter that may be adhering to the camera mount, lens mount, or body cap. To protect the camera when no lens is in place, be sure to replace the supplied body cap. Should you encounter foreign matter that cannot be removed using the image sensor cleaning option (☞ 1075), clean the low-pass filter as described in “Manual Cleaning” (☞ 1078), or have the filter cleaned by authorized Nikon service personnel. Photographs affected by the presence of foreign matter on the sensor can be retouched using the clean image options available in some imaging applications.

## ✔ Servicing the Camera and Accessories

The camera is a precision device and requires regular servicing; Nikon recommends that the camera be inspected once every one to two years, and that it be serviced once every three to five years (note that fees apply to these services).

- Frequent inspection and servicing are particularly recommended if the camera is used professionally.
  - Any accessories regularly used with the camera, such as lenses or optional flash units, should be included when the camera is inspected or serviced.
-

## **Replacing the Clock Battery**

The camera clock is powered by a CR1616 lithium battery. CR1616 batteries have a life of about two years. If the  icon is displayed in the top control panel while the standby timer is on, the battery is running low and needs to be replaced. When the battery is exhausted, the  icon will flash while the standby timer is on, indicating that although photographs can still be taken, they will not be stamped with the correct time and date.

### **■ Replacing the Clock Battery**

- 1 Turn the camera off and remove the main battery.**
- 2 Slide the clock battery chamber cover, which is located on the roof of the main battery chamber, toward the front of the main battery chamber.**
- 3 Remove the clock battery.**



- 
- 4** Insert a new CR1616 lithium battery so that the positive side (the side marked with “+” and the battery name) is visible.

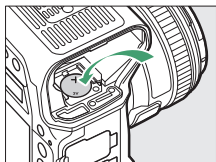

- 
- 5** Slide the clock battery chamber cover towards the back of the main battery chamber.

Stop when the cover clicks into place.

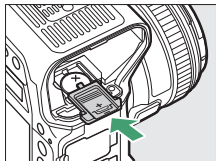

- 
- 6** Reinsert the main battery.

- 
- 7** Set the camera clock.

The **CLOCK** icon will flash in the top control panel until the clock is set.

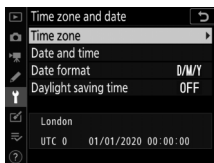

---

**✓ Inserting the Clock Battery**

Insert the clock battery in the correct orientation. Inserting the battery incorrectly could not only prevent the clock from functioning but could damage the camera.

---



# Caring for the Camera and Battery: Cautions

## Camera Care

### ● **Do Not Drop**

Do not drop the camera or lens or subject them to blows. The product may malfunction if subjected to strong shocks or vibration.

### ● **Keep Dry**

Keep the camera dry. Rusting of the internal mechanism caused by water inside the camera can not only be expensive to repair but can in fact cause irreparable damage.

### ● **Avoid Sudden Changes in Temperature**

Sudden changes in temperature, such as those that occur when entering or leaving a heated building on a cold day, can cause condensation inside the device. To prevent condensation, place the device in a carrying case or plastic bag before exposing it to sudden changes in temperature.

### ● **Keep Away from Strong Magnetic Fields**

Static charges or the magnetic fields produced by equipment such as radio transmitters could interfere with the monitor, corrupt data stored on the memory card, or affect the product's internal circuitry.

### ● **Do Not Leave the Lens Pointed at the Sun**

Do not leave the lens pointed at the sun or other strong light source for extended periods. Intense light may damage the image sensor or cause fading or “burn in”. Photographs taken with the camera may exhibit a white blur effect.

### ● **Lasers and Other Bright Light Sources**

Do not direct lasers or other extremely bright light sources toward the lens, as this could damage the camera’s image sensor.

### ● **Cleaning**

When cleaning the camera body, use a blower to gently remove dust and lint, then wipe gently with a soft, dry cloth. After using the camera at the beach or seaside, wipe off any sand or salt using a cloth lightly dampened in fresh water and then dry the camera thoroughly. In rare instances, static electricity may cause the LCD displays to light up or go dark; this does not indicate a malfunction. The display will soon return to normal.

### ● **Cleaning the Lens and Mirror**

These elements are easily damaged: remove dust and lint with a blower. If using an aerosol blower, keep the can vertical to prevent the discharge of liquid that could damage glass elements. To remove fingerprints and other stains from the lens, apply a small amount of lens cleaner to a soft cloth and wipe the lens carefully.

### ● **Cleaning the Low-Pass Filter**

For information on cleaning the low-pass filter, see “The Low-Pass Filter” (□ 1075) and “Manual Cleaning” (□ 1078).

### ● **The Lens Contacts**

Keep the lens contacts clean.

### ● **Do Not Touch the Shutter Curtain**

- The shutter curtain is extremely thin and easily damaged: under no circumstances should you exert pressure on the curtain, poke it with cleaning tools, or subject it to powerful air currents from a blower. These actions could scratch, deform, or tear the curtain.
- The shutter curtain may appear to be unevenly colored; this does not indicate a malfunction. It also has no effect on pictures.

### ● **Store in a Well-Ventilated Area**

To prevent mold or mildew, store the camera in a dry, well-ventilated area. Do not store the camera with naphtha or camphor moth balls, next to equipment that produces strong electromagnetic, or where it will be exposed to extremely high temperatures, for example near a heater or in an enclosed vehicle on a hot day. Failure to observe these precautions could result in product malfunction.

### ● **Long-Term Storage**

To prevent damage caused by, for example, leaking battery fluid, remove the battery if the product will not be used for an extended period. Store the camera in a plastic bag containing a desiccant. Do not, however, store the leather camera case in a plastic bag, as this may cause the material to deteriorate. Store the battery in a cool, dry place. Note that desiccant gradually loses its capacity to absorb moisture and should be replaced at regular intervals. To prevent mold or mildew, take the camera out of storage at least once a month, insert the battery, and release the shutter a few times.

## ● **Turn the Product Off Before Removing or Disconnecting the Power Source**

Removing or disconnecting the power source while the camera is on could damage the product. Particular care should be taken not to remove or disconnect the power source while images are being recorded or deleted.

## ● **Notes on the Monitor**

- The monitor is constructed with extremely high precision; at least 99.99% of pixels are effective, with no more than 0.01% being missing or defective. Hence while these displays may contain pixels that are always lit (white, red, blue, or green) or always off (black), this is not a malfunction. Images recorded with the device are unaffected. Your understanding is requested.
- Images in the monitor may be difficult to see in a bright light.
- Do not apply pressure to the monitor. The monitor could malfunction or suffer damage. Dust or lint on the monitor can be removed with a blower. Stains can be removed by wiping the monitor lightly with a soft cloth or chamois leather. Should the monitor break, care should be taken to avoid injury from broken glass. Be careful that liquid crystal from the monitor does not touch the skin or enter the eyes or mouth.

## ● **Dry the Accessory Shoe Cover**

If the camera is used in the rain, water may penetrate the supplied accessory shoe cover. Remove and dry the accessory shoe cover after using the camera in the rain.

## **Battery Care**

### **● Precautions for Use**

- If improperly handled, batteries may rupture or leak, causing the product to corrode. Observe the following precautions when handling batteries:
  - Turn the product off before replacing the battery.
  - Batteries may be hot after extended use.
  - Keep the battery terminals clean.
  - Use only batteries approved for use in this equipment.
  - Do not short or disassemble batteries or expose them to flame or excessive heat.
  - Replace the terminal cover when the battery is not inserted in the camera or charger.
- If the battery is hot, for example immediately after use, wait for it to cool before charging. Attempting to charge the battery while its internal temperature is elevated will impair battery performance, and the battery may not charge or charge only partially.
- If the battery will not be used for some time, insert it in the camera and run it flat before removing it from the camera for storage. The battery should be stored in a cool location with an ambient temperature of 15 °C to 25 °C (59 °F to 77 °F). Avoid hot or extremely cold locations.
- Batteries should be charged within six months of use. During long periods of disuse, charge the battery and use the camera to run it flat once every six months before returning it to a cool location for storage.
- Remove the battery from the camera or charger when not in use. The camera and charger draw minute amounts of charge even when off and could draw the battery down to the point that it will no longer function.

- Do not use the battery at ambient temperatures below 0 °C (32 °F) or above 40 °C (104 °F). Failure to observe this precaution could damage the battery or impair its performance. Charge the battery indoors at ambient temperatures of 5 °C–35 °C (41 °F–95 °F). The battery will not charge if its temperature is below 0 °C (32 °F) or above 60 °C (140 °F).
- Capacity may be reduced and charging times increase at battery temperatures from 0 °C (32 °F) to 15 °C (59 °F) and from 45 °C (113 °F) to 60 °C (140 °F).
- Batteries in general exhibit a drop in capacity at low ambient temperatures. Even fresh batteries charged at temperatures under about 5 °C (41 °F) may show a temporary increase from “0” to “1” in the setup menu **[Battery info]** age display, but the display will return to normal once the battery has been recharged at a temperature of about 20 °C (68 °F) or higher.
- Battery capacity drops at low temperatures. The change in capacity with temperature is reflected in the camera battery-level display. As a result, the battery display may show a drop in capacity as the temperature drops, even if the battery is fully charged.
- Batteries may be hot after use. Observe due caution when removing batteries from the camera.

### ● **Charge Batteries Before Use**

Charge the battery before use. The supplied battery is not fully charged at shipment.

### ● **Ready Spare Batteries**

Before taking photographs, ready a spare battery and keep it fully charged. Depending on your location, it may be difficult to purchase replacement batteries on short notice.

### ● **Have Fully-Charged Spare Batteries Ready on Cold Days**

Partially-charged batteries may not function on cold days. In cold weather, charge one battery before use and keep another in a warm place, ready to be exchanged as necessary. Once warmed, a cold battery may recover some of its charge.

### ● **Battery Level**

- Turning the camera on or off repeatedly when the battery is fully discharged will shorten battery life. Batteries that have been fully discharged must be charged before use.
- A marked drop in the time a fully charged battery retains its charge when used at room temperature indicates that it requires replacement. Purchase a new rechargeable battery.

### ● **Do Not Attempt to Charge Fully-Charged Batteries**

Continuing to charge the battery after it is fully charged can impair battery performance.

### ● **Recycling Used Batteries**

Recycle rechargeable batteries in accord with local regulations, being sure to first insulate the terminals with tape.

## **Using the Charger**

- Do not short the charger terminals. Failure to observe this precaution could result in overheating and damage to the charger.
- Unplug the charger when it is not in use.
- Use the MH-26a with compatible batteries only.
- Do not use chargers with damage that leaves the interior exposed or that produce unusual sounds when used.



## Exposure Program

The following graph shows the exposure program for mode **P** (ISO 100, maximum lens aperture f/1.4):

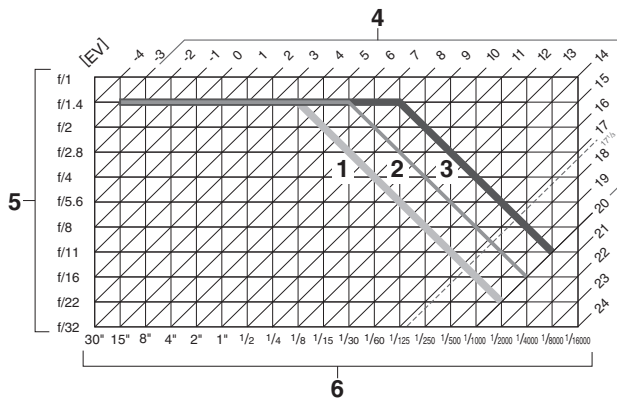

**1** F (lens focal length)  $\leq$  55 mm

**2** 55 mm  $<$  F  $\leq$  135 mm

**3** 135 mm  $<$  F

**4** Metering range: -3 to 20 EV

**5** Aperture

**6** Seconds (shutter speed)

- The maximum and minimum values for EV vary with the metering range.
- When matrix metering is used, values over  $17 \frac{1}{3}$  EV are reduced to  $17 \frac{1}{3}$  EV.

# Specifications

## Nikon D6 Digital Camera

Type	
Type	Single-lens reflex digital camera
Lens mount	Nikon F mount (with AF coupling and AF contacts)
Effective angle of view	Nikon FX format
Effective pixels	
Effective pixels	20.8 million
Image sensor	
Type	35.9 × 23.9 mm CMOS sensor
Total pixels	21.33 million
Dust-reduction system	Image sensor cleaning, Image Dust Off reference data (Capture NX-D software required)

Image size  
(pixels)

- **[FX (36 × 24)] selected for image area:**
  - 5568 × 3712 (Large: 20.7 M)
  - 4176 × 2784 (Medium: 11.6 M)
  - 2784 × 1856 (Small: 5.2 M)
- **[1.2 × (30 × 20)] selected for image area:**
  - 4640 × 3088 (Large: 14.3 M)
  - 3472 × 2312 (Medium: 8.0 M)
  - 2320 × 1544 (Small: 3.6 M)
- **[DX (24 × 16)] selected for image area:**
  - 3648 × 2432 (Large: 8.9 M)
  - 2736 × 1824 (Medium: 5.0 M)
  - 1824 × 1216 (Small: 2.2 M)
- **[5:4 (30 × 24)] selected for image area:**
  - 4640 × 3712 (Large: 17.2 M)
  - 3472 × 2784 (Medium: 9.7 M)
  - 2320 × 1856 (Small: 4.3 M)
- **[1:1 (24 × 24)] selected for image area:**
  - 3712 × 3712 (Large: 13.8 M)
  - 2784 × 2784 (Medium: 7.8 M)
  - 1856 × 1856 (Small: 3.4 M)
- **[16:9 (36 × 20)] selected for image area:**
  - 5568 × 3128 (Large: 17.4 M)
  - 4176 × 2344 (Medium: 9.8 M)
  - 2784 × 1560 (Small: 4.3 M)
- **Photographs taken while filming movies at a frame size of 3840 × 2160:** 3840 × 2160
- **Photographs taken while filming movies at a frame size of 1920 × 1080:** 1920 × 1080
- **Photographs taken while filming movies at a frame size of 1280 × 720:** 1280 × 720

Storage	
<b>File format (image quality)</b>	<ul style="list-style-type: none"> <li>• <b>NEF (RAW):</b> 12 or 14 bit (lossless compressed, compressed, or uncompressed); large, medium, and small available (medium and small images are recorded at a bit depth of 12 bits using lossless compression)</li> <li>• <b>JPEG:</b> JPEG-Baseline compliant with fine (approx. 1:4), normal (approx. 1:8), or basic (approx. 1:16) compression; size-priority and optimal-quality compression available</li> <li>• <b>NEF (RAW)+JPEG:</b> Single photograph recorded in both NEF (RAW) and JPEG formats</li> </ul>
<b>Picture Control System</b>	Auto, Standard, Neutral, Vivid, Monochrome, Portrait, Landscape, Flat, Creative Picture Controls (Dream, Morning, Pop, Sunday, Somber, Dramatic, Silence, Bleached, Melancholic, Pure, Denim, Toy, Sepia, Blue, Red, Pink, Charcoal, Graphite, Binary, Carbon); selected Picture Control can be modified; storage for custom Picture Controls
<b>Media</b>	CFexpress (Type B) and XQD memory cards
<b>Double card slots</b>	The card in Slot 2 can be used for overflow or backup storage, for separate storage of NEF (RAW) and JPEG copies of photos taken at image quality settings of NEF (RAW) + JPEG, or to store separate copies of JPEG photos at different sizes and compression ratios; pictures can be copied between cards
<b>File system</b>	DCF 2.0, Exif 2.31

<b>Viewfinder</b>	
<b>Viewfinder</b>	Eye-level pentaprism single-lens reflex viewfinder
<b>Frame coverage</b>	<ul style="list-style-type: none"> <li>• <b>FX</b>: Approx. 100% horizontal and 100% vertical</li> <li>• <b>1.2x</b>: Approx. 97% horizontal and 97% vertical</li> <li>• <b>DX</b>: Approx. 97% horizontal and 97% vertical</li> <li>• <b>5:4</b>: Approx. 97% horizontal and 100% vertical</li> <li>• <b>1:1</b>: Approx. 95% horizontal and 100% vertical</li> <li>• <b>16:9</b>: Approx. 100% horizontal and 96% vertical</li> </ul>
<b>Magnification</b>	Approx. 0.72× (50 mm f/1.4 lens at infinity, $-1.0\text{ m}^{-1}$ )
<b>Eyepoint</b>	17 mm ( $-1.0\text{ m}^{-1}$ ; from center surface of viewfinder eyepiece lens)
<b>Diopter adjustment</b>	$-3$ – $+1\text{ m}^{-1}$
<b>Focusing screen</b>	Type B BriteView Clear Matte Mark X screen (with AF-area brackets; framing grid can be displayed)
<b>Reflex mirror</b>	Quick return
<b>Depth-of-field preview</b>	Pressing <b>Pv</b> button stops lens aperture down to value selected by user ( <b>A</b> and <b>M</b> modes) or by camera ( <b>P</b> and <b>S</b> modes)
<b>Lens aperture</b>	Instant return, electronically controlled

Lens	
<b>Compatible lenses</b>	<ul style="list-style-type: none"> <li>• <b>Types G, E, and D</b> (some restrictions apply to PC lenses)</li> <li>• <b>Other AF NIKKOR lenses</b> (excluding IX NIKKOR lenses and lenses for the F3AF)</li> <li>• <b>AI-P NIKKOR lenses</b></li> <li>• <b>DX lenses</b> (using [DX (24 × 16)] image area)</li> <li>• <b>Non-CPU AI lenses</b> (modes <b>A</b> and <b>M</b> only)</li> <li>• During viewfinder photography, the electronic rangefinder can be used with lenses that have a maximum aperture of f/5.6 or faster. With lenses that have a maximum aperture of f/8 or faster, the electronic rangefinder supports 15 focus points.</li> </ul>

Shutter	
<b>Type</b>	Electronically-controlled vertical-travel focal-plane mechanical shutter; electronic front-curtain shutter; electronic shutter
<b>Speed</b>	1/8000–30 s (choose from step sizes of 1/3, 1/2, and 1 EV, extendable to 900 s in mode <b>M</b> ), Bulb; Time; X250
<b>Flash sync speed</b>	X=1/250 s; synchronizes with shutter at 1/250 s or slower <ul style="list-style-type: none"> <li>• Auto FP high-speed sync supported</li> </ul>

Release	
<b>Release mode</b>	<b>S</b> (single frame), <b>CL</b> (continuous low speed), <b>CH</b> (continuous high speed), <b>Q</b> (quiet shutter-release), <b>⌚</b> (self-timer), <b>MUP</b> (mirror up)
<b>Approximate frame advance rate</b>	<ul style="list-style-type: none"> <li>• <b>CL</b>: 1–10 fps</li> <li>• <b>CH</b>: 10–14 fps</li> <li>• <b>Q</b>: 1–5 fps</li> </ul>
<b>Self-timer</b>	2 s, 5 s, 10 s, 20 s; 1–9 exposures at intervals of 0.5, 1, 2, or 3 s
Exposure	
<b>Metering system</b>	<ul style="list-style-type: none"> <li>• <b>Viewfinder photography</b>: TTL exposure metering using RGB sensor with approximately 180K (180,000) pixels</li> <li>• <b>Live view</b>: TTL exposure metering performed by image sensor</li> </ul>

Exposure	
<b>Metering mode</b>	<ul style="list-style-type: none"> <li>• <b>Matrix:</b> 3D color matrix metering III (type G, E, and D lenses); color matrix metering III (other CPU lenses); color matrix metering available with non-CPU lenses if user provides lens data</li> <li>• <b>Center-weighted:</b> Weight of 75% given to 12 mm circle in center of frame; diameter of circle can be changed to 8, 15, or 20 mm, or weighting can be based on average of entire frame (non-CPU and AF-S Fisheye NIKKOR 8–15mm f/3.5–4.5E ED lenses use 12-mm circle)</li> <li>• <b>Spot:</b> Meters circle approximately 4 mm in diameter (about 1.5% of frame) centered on selected focus point (on center focus point when non-CPU or AF-S Fisheye NIKKOR 8–15mm f/3.5–4.5E ED lens is used)</li> <li>• <b>Highlight-weighted:</b> Available with type G, E, and D lenses</li> </ul>
<b>Range *</b>	<ul style="list-style-type: none"> <li>• <b>Matrix or center-weighted metering:</b> –3–+20 EV</li> <li>• <b>Spot metering:</b> 2–20 EV</li> <li>• <b>Highlight-weighted metering:</b> 0–20 EV</li> </ul> <p>* Figures are for ISO 100 and f/1.4 lens at 20 °C/68 °F</p>
<b>Exposure meter coupling</b>	Combined CPU and AI





Exposure	
<b>Mode</b>	<b>P</b> (programmed auto with flexible program); <b>S</b> (shutter-priority auto); <b>A</b> (aperture-priority auto); <b>M</b> (manual)
<b>Exposure compensation</b>	-5 – +5 EV; -3 – +3 EV when filming movies (choose from step sizes of 1/3, 1/2, and 1 EV)
<b>Exposure lock</b>	Luminosity locked at detected value
<b>ISO sensitivity (Recommended Exposure Index)</b>	ISO 100–102400 (choose from step sizes of 1/3, 1/2, and 1 EV); can also be set to approx. 0.3, 0.5, 0.7, or 1 EV (ISO 50 equivalent) below ISO 100 or to approx. 0.3, 0.5, 0.7, 1, 2, 3, 4, or 5 EV (ISO 3280000 equivalent) above ISO 102400; auto ISO sensitivity control available
<b>Active D-Lighting</b>	Can be selected from Auto, Extra high +2, Extra high +1, High, Normal, Low, and Off
Autofocus	
<b>Type</b>	<ul style="list-style-type: none"> <li>• <b>Viewfinder photography:</b> TTL phase-detection; 105 focus points, all of which are cross-type sensors and 15 of which support f/8; detection performed by Multi-CAM 37K autofocus sensor module; autofocus fine-tuning supported</li> <li>• <b>Live view:</b> Contrast-detect AF available at all points in frame; focus point selected by camera when face detection or subject-tracking is used</li> </ul>

<b>Autofocus</b>	
<b>Detection range</b>	-4.5 – +20 EV (ISO 100, 20 °C/68 °F)
<b>Lens servo</b>	<ul style="list-style-type: none"> <li>• <b>Autofocus (AF):</b> Single-servo AF (<b>AF-S</b>); continuous-servo AF (<b>AF-C</b>, viewfinder photography only; predictive focus tracking activated automatically according to subject status); full-time AF (<b>AF-F</b>; available only during live view and movie recording)</li> <li>• <b>Manual focus (M):</b> Electronic rangefinder can be used</li> </ul>
<b>Focus points</b>	105 focus points (number available for selection in viewfinder photography can be chosen from 105, 27, and 15)
<b>AF-area mode</b>	<ul style="list-style-type: none"> <li>• <b>Viewfinder photography:</b> Single-point AF; 9-, 25-, 49-, or 105- point dynamic-area AF; 3D-tracking; group-area AF; group-area AF (C1); group-area AF (C2); auto-area AF</li> <li>• <b>Live view:</b> Face-detection AF, wide-area AF, normal-area AF, subject-tracking AF</li> </ul>
<b>Focus lock</b>	Focus can be locked by pressing shutter-release button halfway (single-servo AF/ <b>AF-S</b> ) or by pressing the center of the sub-selector

**Flash**

<b>Flash control</b>	<b>TTL flash control using RGB sensor with approximately 180K (180,000) pixels:</b> i-TTL flash control; i-TTL balanced fill-flash for digital SLR is used with matrix, center-weighted, and highlight-weighted metering, standard i-TTL fill-flash for digital SLR with spot metering
<b>Flash mode</b>	Front-curtain sync, red-eye reduction, slow sync, red-eye reduction with slow sync, rear-curtain sync, off
<b>Flash compensation</b>	-3 – +1 EV (choose from step sizes of $\frac{1}{3}$ , $\frac{1}{2}$ and 1 EV)
<b>Flash-ready indicator</b>	Lights when optional flash unit is fully charged; flashes after flash is fired at full output
<b>Accessory shoe</b>	ISO 518 hot-shoe with sync and data contacts and safety lock
<b>Nikon Creative Lighting System (CLS)</b>	i-TTL flash control, radio-controlled Advanced Wireless Lighting, optical Advanced Wireless Lighting, modeling illumination, FV lock, Color Information Communication, auto FP high-speed sync, AF-assist for multi-area AF (viewfinder photography), unified flash control
<b>Sync terminal</b>	ISO 519 sync terminal with locking thread

<b>White balance</b>	
<b>White balance</b>	Auto (3 types), natural light auto, direct sunlight, cloudy, shade, incandescent, fluorescent (7 types), flash, choose color temperature (2500 K–10,000 K), preset manual (up to 6 values can be stored, spot white balance measurement available during live view), all with fine-tuning
<b>Bracketing</b>	
<b>Bracketing</b>	Exposure and/or flash, white balance, and ADL
<b>Live view</b>	
<b>Mode</b>	 (photo live view),  (movie live view)
<b>Movie</b>	
<b>Metering system</b>	TTL metering using camera image sensor
<b>Metering mode</b>	Matrix, center-weighted, or highlight-weighted

Movie	
<b>Frame size (pixels) and frame rate</b>	<ul style="list-style-type: none"> <li>• 3840 × 2160 (4K UHD): 30p (progressive), 25p, 24p</li> <li>• 1920 × 1080: 60p, 50p, 30p, 25p, 24p</li> <li>• 1280 × 720: 60p, 50p</li> <li>• 1920 × 1080 crop: 60p, 50p, 30p, 25p, 24p</li> <li>* Actual frame rates for 60p, 50p, 30p, 25p, and 24p are 59.94, 50, 29.97, 25, and 23.976 fps respectively</li> <li>* Quality selection available at all sizes except 3840 × 2160, when quality is fixed at ★ (high)</li> </ul>
<b>File format</b>	MOV, MP4
<b>Video compression</b>	H.264/MPEG-4 Advanced Video Coding
<b>Audio recording format</b>	Linear PCM (for movies recorded in MOV format) or AAC (for movies recorded in MP4 format)
<b>Audio recording device</b>	Built-in stereo or external microphone with attenuator option; sensitivity adjustable
<b>ISO sensitivity (Recommended Exposure Index)</b>	<ul style="list-style-type: none"> <li>• <b>Mode M:</b> Manual selection (ISO 100 to 102400; choose from step sizes of <math>\frac{1}{3}</math>, <math>\frac{1}{2}</math>, and 1 EV) with additional options available equivalent to approximately 0.3, 0.5, 0.7, 1, 2, 3, 4, or 5 EV (ISO 3280000 equivalent) above ISO 102400; auto ISO sensitivity control (ISO 100 to Hi 5) available with selectable upper limit</li> <li>• <b>Modes P, S, and A:</b> Auto ISO sensitivity control (ISO 100 to Hi 5) with selectable upper limit</li> </ul>

<b>Movie</b>	
<b>Active D-Lighting</b>	Can be selected from Extra high, High, Normal, Low, and Off
<b>Other options</b>	Time-lapse movie recording, electronic vibration reduction, time codes
<b>Monitor</b>	
<b>Monitor</b>	8-cm/3.2-in., approx. 2359k-dot (XGA) TFT touch-sensitive LCD with 170 ° viewing angle, approximately 100% frame coverage, 11-level manual brightness adjustment, and color balance control
<b>Playback</b>	
<b>Playback</b>	Full-frame and thumbnail (4, 9, or 72 images) playback with playback zoom, playback zoom cropping, movie playback, photo and/or movie slide shows, histogram display, highlights, photo information, location data display, picture rating, auto image rotation, index marking, voice memo input and playback, and IPTC information embedding and display

<b>Interface</b>	
<b>USB</b>	Type C USB connector (SuperSpeed USB); connection to built-in USB port is recommended
<b>HDMI output</b>	Type C HDMI connector
<b>Audio input</b>	Stereo mini-pin jack (3.5 mm diameter; plug-in power supported)
<b>Audio output</b>	Stereo mini-pin jack (3.5 mm diameter)
<b>Ten-pin remote terminal</b>	Built-in (can be used with MC-30A/MC-36A remote cords and other optional accessories)
<b>Ethernet</b>	<p>RJ-45 connector</p> <ul style="list-style-type: none"> <li>• <b>Standards:</b> IEEE 802.3ab (1000BASE-T)/IEEE 802.3u (100BASE-TX)/IEEE 802.3 (10BASE-T)</li> <li>• <b>Data rates</b> *: 10/100/1000 Mbps with auto detect</li> <li>• <b>Port:</b> 1000BASE-T/100BASE-TX/10BASE-T (AUTO-MDIX)</li> </ul> <p>* Maximum logical data rates according to IEEE standard; actual rates may differ.</p>
<b>Peripheral connector</b>	For WT-6

## Wi-Fi/Bluetooth

### Wi-Fi

- **Standards:**
  - IEEE 802.11b/g/n (Africa, Asia, and Oceania)
  - IEEE 802.11b/g/n/a/ac (Europe, U.S.A., Canada, Mexico)
  - IEEE 802.11b/g/n/a (other countries in the Americas)
- **Operating frequency:**
  - 2412–2462 MHz (channel 11; Africa, Asia, and Oceania)
  - 2412–2462 MHz (channel 11) and 5180–5825 MHz (U.S.A., Canada, Mexico)
  - 2412–2462 MHz (channel 11) and 5180–5805 MHz (other countries in the Americas)
  - 2412–2462 MHz (channel 11) and 5745–5805 MHz (Georgia)
  - 2412–2462 MHz (channel 11) and 5180–5320 MHz (other European countries)
- **Maximum output power (EIRP):**
  - 2.4 GHz band: 6.8 dBm
  - 5 GHz band: 6.3 dBm (Georgia)
  - 5 GHz band: 9.3 dBm (other countries)
- **Authentication:** Open system, WPA2-PSK



**Wi-Fi/Bluetooth**

<b>Bluetooth</b>	<ul style="list-style-type: none"><li>• <b>Communication protocols:</b> Bluetooth Specification Version 4.2</li><li>• <b>Operating frequency:</b><ul style="list-style-type: none"><li>- Bluetooth: 2402–2480 MHz</li><li>- Bluetooth Low Energy: 2402–2480 MHz</li></ul></li><li>• <b>Maximum output power (EIRP):</b><ul style="list-style-type: none"><li>- Bluetooth: 1.3 dBm</li><li>- Bluetooth Low Energy: –0.2 dBm</li></ul></li></ul>
<b>Range (line of sight)</b>	Approximately 10 m (32 ft) * * Without interference. Range may vary with signal strength and presence or absence of obstacles.

**Location data**

<b>Supported GNS systems</b>	GPS (USA), GLONASS (Russia), QZSS (Japan)
<b>Data acquired</b>	Latitude, longitude, altitude, UTC (Universal Coordinated Time)
<b>Clock synchronization</b>	Camera clock can be set to time acquired via GNSS
<b>Track logs</b>	NMEA-compliant
<b>Log interval</b>	15 s, 30 s, 1 min., 2 min., 5 min.

<b>Location data</b>	
<b>Maximum log recording time</b>	6, 12, or 24 hours
<b>Log deletion</b>	Supported
<b>Power source</b>	
<b>Battery</b>	One EN-EL18c rechargeable Li-ion battery * * EN-EL18b/EN-EL18a/EN-EL18 batteries can also be used. Note, however, that fewer pictures can be taken on a single charge with an EN-EL18 than with an EN-EL18c/EN-EL18b/EN-EL18a.
<b>AC adapter</b>	EH-6c AC adapter; requires EP-6 power connector (available separately)
<b>Tripod socket</b>	
<b>Tripod socket</b>	1/4 in. (ISO 1222)
<b>Dimensions/weight</b>	
<b>Dimensions (W×H×D)</b>	Approx. 160 × 163 × 92 mm (6.3 × 6.5 × 3.7 in.)
<b>Weight</b>	Approx. 1450 g (3 lb. 3.2 oz.) with battery and two CFexpress memory cards but without body cap and accessory shoe cover; approx. 1270 g/2 lb. 12.8 oz. (camera body only)

## Operating environment

<b>Temperature</b>	0 °C–40 °C (+32 °F–104 °F)
<b>Humidity</b>	85% or less (no condensation)

- Unless otherwise stated, all measurements are performed in conformity with Camera and Imaging Products Association (CIPA) standards or guidelines.
- All figures are for a camera with a fully-charged battery.
- The sample images displayed on the camera and the images and illustrations in the manuals are for expository purposes only.
- Nikon reserves the right to change the appearance and specifications of the hardware and software described in this manual at any time and without prior notice. Nikon will not be held liable for damages that may result from any mistakes that this manual may contain.

## ■ MH-26a Battery Charger

<b>Rated input</b>	AC 100 to 240 V, 50/60 Hz
<b>Rated output</b>	DC 12.6 V/1.2 A
<b>Supported batteries</b>	Nikon EN-EL18c/EN-EL18b/EN-EL18a/EN-EL18 rechargeable Li-ion batteries
<b>Charging time per battery</b>	Approx. 2 hours and 35 minutes * Time required to charge battery at an ambient temperature of 25 °C (77 °F) when no charge remains
<b>Operating temperature</b>	0 °C–40 °C (+32 °F–104 °F)
<b>Dimensions (W × H × D)</b>	Approx. 160 × 85 × 50.5 mm (6.3 × 3.3 × 2 in.)
<b>Length of power cable</b>	Approx. 1.8 m/6 ft (U.S.A. and Canada) or 1.5 m/4.9 ft (other countries)
<b>Weight</b>	Approx. 285 g (10.1 oz), including two contact protectors but excluding power cable; approx. 265 g (9.3 oz), excluding both contact protectors and power cable

The symbols on this product represent the following:

~ AC, = DC, □ Class II equipment (the construction of the product is double-insulated)

## ■ EN-EL18c Rechargeable Li-ion Battery

<b>Type</b>	Rechargeable lithium-ion battery
<b>Rated capacity</b>	10.8 V/2500 mAh
<b>Operating temperature</b>	0 °C–40 °C (+32 °F–104 °F)
<b>Dimensions (W × H × D)</b>	Approx. 56.5 × 27 × 82.5 mm (2.2 × 1.1 × 3.2 in.)
<b>Weight</b>	Approx. 160 g (5.6 oz), excluding terminal cover

## Calibrating Batteries

The MH-26a battery charger can detect whether batteries require calibration and calibrate them as necessary to ensure the accuracy of the battery level display. Calibration status and progress are shown by lamps on the battery charger:

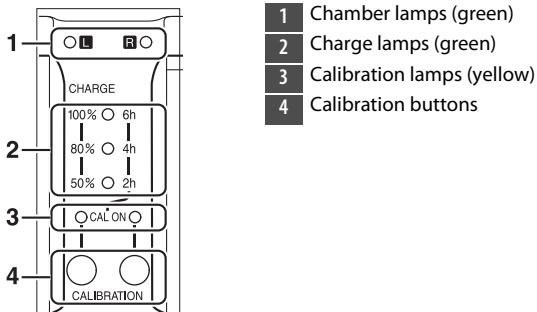

If the calibration lamp for the current battery chamber flashes when a battery is inserted, the battery needs to be calibrated.

To begin calibration, press the calibration button for the current chamber for about a second. The chamber lamp for the current battery chamber flashes while calibration is in progress.

The display can be read as follows:

		Approximate time needed to recalibrate battery			
		Under 2 hours	2–4 hours	4–6 hours	Over 6 hours
<b>Charge lamps (green)</b>	<b>2h</b>	● (off)	○ (on)	○ (on)	○ (on)
	<b>4h</b>	● (off)	● (off)	○ (on)	○ (on)
	<b>6h</b>	● (off)	● (off)	● (off)	○ (on)
<b>Calibration (CAL ON) lamp (yellow): L/R</b>		○ (on)	○ (on)	○ (on)	○ (on)

Although calibration is recommended for accurate measurement of battery charge state, calibration need not be performed when the calibration lamp flashes. Once begun, calibration can be interrupted as desired.

- If the calibration button is not pressed while the calibration lamp is flashing, normal charging will begin after about ten seconds.
- To interrupt calibration, press the calibration button again. Calibration will end and charging will begin.

When calibration is complete, the calibration and charge lamps will turn off and charging will begin immediately.

---

### ✔ Warning Indicators

- **If the “L” and “R” chamber and calibration lamps flash on and off in sequence when no battery is inserted...**

...there is a problem with the charger. Unplug the charger and consult a Nikon-authorized service representative.

- **If the “L” and “R” chamber and calibration lamps flash on and off in sequence when a battery is inserted...**

...a problem has occurred with the battery or charger during charging. Remove the battery, unplug the charger, and consult a Nikon-authorized service representative.

---

### ✔ Charging and Calibrating Two Batteries

If batteries are inserted in both chambers, they will be charged in the order inserted. If a calibration button is pressed when either calibration lamp is flashing, the charger will calibrate and then charge whichever of the batteries was the first to be inserted. The second battery cannot be calibrated or charged until the process is complete.

---



---

## ✔ **Disposing of Data Storage Devices**

Please note that deleting images or formatting memory cards or other data storage devices does not completely erase the original image data. Deleted files can sometimes be recovered from discarded storage devices using commercially available software, potentially resulting in the malicious use of personal image data. Ensuring the privacy of such data is the user's responsibility.

Before discarding a data storage device or transferring ownership to another person, erase all data using commercial deletion software, or format the device and then completely refill it with images containing no private information (for example, pictures of empty sky). Care should be taken to avoid injury when physically destroying data storage devices. Before discarding the camera or transferring ownership to another person, you should also use the **[Reset all settings]** item in the camera setup menu to delete network settings and other personal information.

## ✔ Supported Standards

- **DCF Version 2.0:** The Design Rule for Camera File System (DCF) is a standard widely used in the digital camera industry to ensure compatibility among different makes of camera.
  - **Exif version 2.31:** The camera supports Exif (Exchangeable Image File Format for Digital Still Cameras) version 2.31, a standard introduced with the goal of improving the interoperability of printers and digital cameras, making it easier to produce high-quality prints. Information stored with photographs is used for optimal color reproduction when the images are output on Exif-compliant printers. See the printer manual for details.
  - **HDMI:** High-Definition Multimedia Interface is a standard for multimedia interfaces used in consumer electronics and AV devices. This standard ensures that audiovisual data and control signals can be transmitted to HDMI-compliant devices via a single cable connection.
-

## Approved Memory Cards

- The camera can be used with CFexpress (Type B) and XQD memory cards.
- Cards with write speeds of 45 MB/s (300×) or better are recommended for movie recording and playback. Slower speeds may result in recording being interrupted. Playback may also be interrupted or jerky when movies are viewed on the camera.
- Contact the manufacturer for information on features, operation, and limitations on use.

## Memory Card Capacity

The following table shows the approximate number of pictures that can be stored on a 128 GB <sup>1</sup> card at different image area, image quality, and image size settings. Actual capacity varies with shooting conditions and the type of card.

### **[FX (36 × 24)] Selected for Image Area**

This category also includes images taken with non-DX lenses when [On] is selected for [Image area] > [Auto DX crop].

Image quality	Image size	File size	Number of exposures remaining <sup>2</sup>	Buffer capacity <sup>2, 3</sup>
<b>NEF (RAW), Lossless compressed, 12-bit</b>	Large	Approx. 20.2 MB	3500 frames	184 frames
	Medium	Approx. 14.6 MB	4700 frames	79 frames
	Small	Approx. 11.1 MB	6200 frames	84 frames
<b>NEF (RAW), Lossless compressed, 14-bit</b>	Large	Approx. 25.1 MB	3000 frames	146 frames
<b>NEF (RAW), Compressed, 12-bit</b>	Large	Approx. 18.4 MB	4700 frames	186 frames
<b>NEF (RAW), Compressed, 14-bit</b>	Large	Approx. 22.6 MB	3900 frames	152 frames

<b>Image quality</b>	<b>Image size</b>	<b>File size</b>	<b>Number of exposures remaining <sup>2</sup></b>	<b>Buffer capacity <sup>2, 3</sup></b>
<b>NEF (RAW), Uncompressed, 12-bit</b>	Large	Approx. 33.1 MB	3500 frames	133 frames
<b>NEF (RAW), Uncompressed, 14-bit</b>	Large	Approx. 38.0 MB	3000 frames	105 frames
<b>JPEG fine <sup>4</sup></b>	Large	Approx. 10.8 MB	8400 frames	200 frames
	Medium	Approx. 6.9 MB	13,900 frames	200 frames
	Small	Approx. 3.8 MB	25,600 frames	200 frames
<b>JPEG normal <sup>4</sup></b>	Large	Approx. 5.7 MB	16,500 frames	200 frames
	Medium	Approx. 3.5 MB	27,000 frames	200 frames
	Small	Approx. 2.0 MB	48,700 frames	200 frames
<b>JPEG basic <sup>4</sup></b>	Large	Approx. 2.6 MB	31,400 frames	200 frames
	Medium	Approx. 1.8 MB	51,300 frames	200 frames
	Small	Approx. 1.1 MB	88,600 frames	200 frames

## **[DX (24 × 16)] Selected for Image Area**

This category also includes images taken with DX lenses when **[On]** is selected for **[Image area] > [Auto DX crop]**.

<b>Image quality</b>	<b>Image size</b>	<b>File size</b>	<b>Number of exposures remaining <sup>2</sup></b>	<b>Buffer capacity <sup>2, 3</sup></b>
<b>NEF (RAW), Lossless compressed, 12-bit</b>	Large	Approx. 9.8 MB	7600 frames	200 frames
	Medium	Approx. 7.2 MB	10,100 frames	129 frames
	Small	Approx. 5.6 MB	13,000 frames	142 frames
<b>NEF (RAW), Lossless compressed, 14-bit</b>	Large	Approx. 11.9 MB	6700 frames	200 frames
<b>NEF (RAW), Compressed, 12-bit</b>	Large	Approx. 9.0 MB	10,000 frames	200 frames
<b>NEF (RAW), Compressed, 14-bit</b>	Large	Approx. 10.8 MB	8500 frames	200 frames
<b>NEF (RAW), Uncompressed, 12-bit</b>	Large	Approx. 15.1 MB	7600 frames	200 frames
<b>NEF (RAW), Uncompressed, 14-bit</b>	Large	Approx. 17.2 MB	6700 frames	200 frames

<b>Image quality</b>	<b>Image size</b>	<b>File size</b>	<b>Number of exposures remaining<sup>2</sup></b>	<b>Buffer capacity<sup>2,3</sup></b>
<b>JPEG fine<sup>4</sup></b>	Large	Approx. 5.6 MB	17,400 frames	200 frames
	Medium	Approx. 3.7 MB	26,300 frames	200 frames
	Small	Approx. 2.3 MB	42,400 frames	200 frames
<b>JPEG normal<sup>4</sup></b>	Large	Approx. 2.9 MB	33,600 frames	200 frames
	Medium	Approx. 2.0 MB	48,700 frames	200 frames
	Small	Approx. 1.3 MB	75,000 frames	200 frames
<b>JPEG basic<sup>4</sup></b>	Large	Approx. 1.6 MB	60,900 frames	200 frames
	Medium	Approx. 1.1 MB	88,600 frames	200 frames
	Small	Approx. 0.8 MB	121,000 frames	200 frames

- 1 Figures are for a Sony CEB-G128 128 GB CFexpress memory card (as of December 2019).
- 2 Number of pictures that can be saved to memory card or stored in memory buffer varies with scene recorded.
- 3 Maximum number of exposures that can be stored in memory buffer at ISO 100. May drop in some situations, including when:
  - An optimal-compression (★) JPEG option is selected for **[Image quality]**
  - **[On]** is selected for **[Auto distortion control]**
- 4 Figures assume a size-priority option (an option not marked with ★) is selected for **[Image quality]**. Selecting an optimal-compression (★) option increases file size; the number of images and buffer capacity drop accordingly.

---

### ✔ **Maximum Number of Photo per Burst**

The maximum number of photographs that can be taken in a single burst can be set to any amount between 1 and 200 using Custom Setting d2 **[Max. continuous release]**.

---



## Battery Endurance

The movie footage or number of shots that can be recorded with a fully-charged EN-EL18c (2500 mAh) rechargeable Li-ion battery <sup>1</sup> is given below. Actual endurance varies with such factors as the condition of the battery, the interval between shots, and the options selected in the camera menus.

- Photographs, single-frame release mode: Approximately 3580 (CIPA standard <sup>2</sup>)
- Photographs, continuous release modes: Approximately 8670 (Nikon standard <sup>3</sup>)
- Movies: Approximately 105 minutes <sup>4</sup>

Actions such as the following can reduce battery endurance:

- Using the monitor, for example for live view photography
- Keeping the shutter-release button pressed halfway
- Repeated autofocus operations
- Taking NEF (RAW) photographs
- Slow shutter speeds

- Using camera Ethernet, Wi-Fi (wireless LAN), and Bluetooth features
- Using the built-in GNSS receiver
- Using the camera with optional accessories connected
- Using VR (vibration reduction) with VR lenses
- Repeatedly zooming in and out with AF-P lenses

To ensure that you get the most from rechargeable Nikon EN-EL18c batteries:

- Keep the battery contacts clean. Soiled contacts can reduce battery performance.
- Use batteries immediately after charging. Batteries will lose their charge if left unused.
- Check the condition of the battery regularly using the **[Battery info]** option in the setup menu. If a  CAL icon appears in the **[Calibration]** field, calibrate the battery in the MH-26a battery charger (📖 1114). If the battery has not been used for more than six months, recharge the battery when calibration is complete.

- 1 EN-EL18b/EN-EL18a/EN-EL18 batteries can also be used. Note, however, that the EN-EL18 can take fewer pictures on a single charge than the EN-EL18c/EN-EL18b/EN-EL18a.
- 2 Lens cycled from infinity to minimum range and one photograph taken at default settings once every 30 s. Live view not used. Measured at 23 °C/73.4 °F ( $\pm 2$  °C/3.6 °F) with an AF-S NIKKOR 24–70mm f/2.8E ED VR lens.
- 3 Image quality set to JPEG normal, image size set to large, shutter speed  $\frac{1}{250}$  s, focus cycled from infinity to minimum range three times after shutter-release button has been pressed halfway for 3 s; six shots are then taken in succession and monitor turned on for 5 s and then turned off; no operations performed until stand-by timer has expired. The cycle is then repeated. Measured at 23 °C/73.4 °F ( $\pm 2$  °C/3.6 °F) with an AF-S NIKKOR 70–200mm f/2.8E FL ED VR lens (VR off).
- 4 Actual battery endurance as measured under conditions specified by the Camera and Imaging Products Association (CIPA). Measured at 23 °C/73.4 °F ( $\pm 2$  °C/3.6 °F) with an AF-S NIKKOR 24–70mm f/2.8E ED VR lens. Measurement performed at default settings.
  - Each shot can be up to 29 minutes 59 seconds in length.
  - If camera temperature rises, recording may end before maximum length or size is reached.

## Location Data (GPS/GLONASS)

### ● Location Data and Track Logs

- If **[On]** is selected for **[Location data (built-in)]** > **[Record location data]** in the setup menu or log tracking is in progress, the camera will continue to acquire log and/or location even while off.
- Personal information may be inferred from the location data stored in track logs or embedded in photos and movies. Exercise caution when sharing photos, movies, or track logs or when posting them to the Internet or other locations where they can be viewed by third parties. Be sure to also read “Disposing of Data Storage Devices” (📖 1117).

### ● Navigation

This product is a camera. It is not intended for use as a navigation or surveying device.

- The location reported by the camera is an approximation only. It is not to be used for surveying or for navigation when travelling by air or car, on foot, or by other means.

### ● Overseas Use

- Before travelling, check with your travel agent or the embassy or tourism board of the countries you will be visiting for information on restrictions that may apply to the use of cameras that support the recording of location data. China, for example, prohibits unauthorized recording of location data. Select **[Off]** for **[Record location data]**.
- As of December, 2019, the location data function may not perform as expected in China and in the vicinity of the Chinese border.

## Trademarks and Licenses

- CFexpress is a trademark of the CompactFlash Association in the United States and other countries.
- NVM Express is a trademark of NVM Express Inc. in the United States and other countries.
- XQD is a trademark of Sony Corporation.
- Windows is either a registered trademark or a trademark of Microsoft Corporation in the United States and/or other countries.
- Apple®, App Store®, the Apple logos, iPhone®, iPad®, iPod touch®, Mac, and macOS are trademarks of Apple Inc. registered in the U.S. and/or other countries.
- Android, Google Play and the Google Play logo are trademarks of Google LLC. The Android robot is reproduced or modified from work created and shared by Google and used according to terms described in the Creative Commons 3.0 Attribution License.
- IOS is a trademark or registered trademark of Cisco Systems, Inc., in the United States and/or other countries and is used under license.

- HDMI, the HDMI logo and High-Definition Multimedia Interface are trademarks or registered trademarks of HDMI Licensing, LLC.

## **HDMI**

- The Bluetooth® word mark and logo are registered trademarks owned by Bluetooth SIG, Inc., and any use of such marks by Nikon is under license.
- Wi-Fi and the Wi-Fi logo are trademarks or registered trademarks of the Wi-Fi Alliance.
- All other trade names mentioned in this manual or the other documentation provided with your Nikon product are trademarks or registered trademarks of their respective holders.

---

Use of the Made for Apple badge means that an accessory has been designed to connect specifically to the Apple products identified in the badge, and has been certified by the developer to meet Apple performance standards. Apple is not responsible for the operation of this device or its compliance with safety and regulatory standards. Please note that the use of this accessory with an Apple product may affect wireless performance.

---

---

### ✔ **FreeType License (FreeType2)**

Portions of this software are copyright © 2012 The FreeType Project (<https://www.freetype.org>). All rights reserved.

### ✔ **MIT License (HarfBuzz)**

Portions of this software are copyright © 2018 The HarfBuzz Project (<https://www.freedesktop.org/wiki/Software/HarfBuzz>). All rights reserved.

### ✔ **Unicode® Character Database License (Unicode® Character Database)**

The software for this product uses the Unicode® Character Database License open-source software. The terms of the software license are as follows:

COPYRIGHT AND PERMISSION NOTICE

Copyright © 1991-2019 Unicode, Inc. All rights reserved.

Distributed under the Terms of Use in

<https://www.unicode.org/copyright.html>.

Permission is hereby granted, free of charge, to any person obtaining a copy of the Unicode data files and any associated documentation (the "Data Files") or Unicode software and any associated documentation (the "Software") to deal in the Data Files or Software without restriction, including without limitation the rights to use, copy, modify, merge, publish, distribute, and/or sell copies of the Data Files or Software, and to permit persons to whom the Data Files or Software are furnished to do so, provided that either

- (i) this copyright and permission notice appear with all copies of the Data Files or Software, or
- (ii) this copyright and permission notice appear in associated Documentation.

THE DATA FILES AND SOFTWARE ARE PROVIDED "AS IS", WITHOUT WARRANTY OF ANY KIND, EXPRESS OR IMPLIED, INCLUDING BUT NOT LIMITED TO THE WARRANTIES OF MERCHANTABILITY, FITNESS FOR A PARTICULAR PURPOSE AND NONINFRINGEMENT OF THIRD PARTY RIGHTS.

IN NO EVENT SHALL THE COPYRIGHT HOLDER OR HOLDERS INCLUDED IN THIS NOTICE BE LIABLE FOR ANY CLAIM, OR ANY SPECIAL INDIRECT OR CONSEQUENTIAL DAMAGES, OR ANY DAMAGES WHATSOEVER RESULTING FROM LOSS OF USE, DATA OR PROFITS, WHETHER IN AN ACTION OF CONTRACT, NEGLIGENCE OR OTHER TORTIOUS ACTION, ARISING OUT OF OR IN CONNECTION WITH THE USE OR PERFORMANCE OF THE DATA FILES OR SOFTWARE.

Except as contained in this notice, the name of a copyright holder shall not be used in advertising or otherwise to promote the sale, use or other dealings in these Data Files or Software without prior written authorization of the copyright holder.

#### **AVC Patent Portfolio License**

THIS PRODUCT IS LICENSED UNDER THE AVC PATENT PORTFOLIO LICENSE FOR THE PERSONAL AND NON-COMMERCIAL USE OF A CONSUMER TO ( i) ENCODE VIDEO IN COMPLIANCE WITH THE AVC STANDARD ("AVC VIDEO") AND/OR (ii) DECODE AVC VIDEO THAT WAS ENCODED BY A CONSUMER ENGAGED IN A PERSONAL AND NONCOMMERCIAL ACTIVITY AND/OR WAS OBTAINED FROM A VIDEO PROVIDER LICENSED TO PROVIDE AVC VIDEO. NO LICENSE IS GRANTED OR SHALL BE IMPLIED FOR ANY OTHER USE. ADDITIONAL INFORMATION MAY BE OBTAINED FROM MPEG LA, L.L.C. SEE <https://www.mpegla.com>



## ✔ BSD License (NVM Express Driver)

The license for the open-source software included in the camera's NVM Express driver is as follows:

### **ComponentName.c**

Copyright (c) 2013, Intel Corporation. All rights reserved.

This program and the accompanying materials are licensed and made available under the terms and conditions of the BSD License which accompanies this distribution. The full text of the license may be found at <http://opensource.org/licenses/bsd-license.php>.

THE PROGRAM IS DISTRIBUTED UNDER THE BSD LICENSE ON AN "AS IS" BASIS, WITHOUT WARRANTIES OR REPRESENTATIONS OF ANY KIND, EITHER EXPRESS OR IMPLIED.

### **NvmExpress.c**

Copyright (c) 2013 - 2017, Intel Corporation. All rights reserved.

This program and the accompanying materials are licensed and made available under the terms and conditions of the BSD License which accompanies this distribution. The full text of the license may be found at <http://opensource.org/licenses/bsd-license.php>.

THE PROGRAM IS DISTRIBUTED UNDER THE BSD LICENSE ON AN "AS IS" BASIS, WITHOUT WARRANTIES OR REPRESENTATIONS OF ANY KIND, EITHER EXPRESS OR IMPLIED.

### **NvmExpress.h**

(C) Copyright 2016 Hewlett Packard Enterprise Development LP

Copyright (c) 2013 - 2018, Intel Corporation. All rights reserved.

This program and the accompanying materials are licensed and made available under the terms and conditions of the BSD License which accompanies this distribution. The full text of the license may be found at <http://opensource.org/licenses/bsd-license.php>.

THE PROGRAM IS DISTRIBUTED UNDER THE BSD LICENSE ON AN "AS IS" BASIS, WITHOUT WARRANTIES OR REPRESENTATIONS OF ANY KIND, EITHER EXPRESS OR IMPLIED.

### **NvmExpressBlockIo.c**

Copyright (c) 2013 - 2018, Intel Corporation. All rights reserved.

This program and the accompanying materials are licensed and made available under the terms and conditions of the BSD License which accompanies this distribution. The full text of the license may be found at <http://opensource.org/licenses/bsd-license.php>.

THE PROGRAM IS DISTRIBUTED UNDER THE BSD LICENSE ON AN "AS IS" BASIS, WITHOUT WARRANTIES OR REPRESENTATIONS OF ANY KIND, EITHER EXPRESS OR IMPLIED.

### **NvmExpressBlockIo.h**

Copyright (c) 2013 - 2016, Intel Corporation. All rights reserved.

This program and the accompanying materials are licensed and made available under the terms and conditions of the BSD License which accompanies this distribution. The full text of the license may be found at <http://opensource.org/licenses/bsd-license.php>

THE PROGRAM IS DISTRIBUTED UNDER THE BSD LICENSE ON AN "AS IS" BASIS, WITHOUT WARRANTIES OR REPRESENTATIONS OF ANY KIND, EITHER EXPRESS OR IMPLIED.

### **NvmExpressDiskInfo.c**

Copyright (c) 2013, Intel Corporation. All rights reserved.

This program and the accompanying materials are licensed and made available under the terms and conditions of the BSD License which accompanies this distribution. The full text of the license may be found at <http://opensource.org/licenses/bsd-license.php>.

THE PROGRAM IS DISTRIBUTED UNDER THE BSD LICENSE ON AN "AS IS" BASIS, WITHOUT WARRANTIES OR REPRESENTATIONS OF ANY KIND, EITHER EXPRESS OR IMPLIED.

### **NvmExpressDiskInfo.h**

Copyright (c) 2013, Intel Corporation. All rights reserved.

This program and the accompanying materials are licensed and made available under the terms and conditions of the BSD License which accompanies this distribution. The full text of the license may be found at <http://opensource.org/licenses/bsd-license.php>

THE PROGRAM IS DISTRIBUTED UNDER THE BSD LICENSE ON AN "AS IS" BASIS, WITHOUT WARRANTIES OR REPRESENTATIONS OF ANY KIND, EITHER EXPRESS OR IMPLIED.

### **NvmExpressDxe.inf**

Copyright (c) 2013 - 2018, Intel Corporation. All rights reserved.

This program and the accompanying materials are licensed and made available under the terms and conditions of the BSD License which accompanies this distribution. The full text of the license may be found at <http://opensource.org/licenses/bsd-license.php>.

THE PROGRAM IS DISTRIBUTED UNDER THE BSD LICENSE ON AN "AS IS" BASIS, WITHOUT WARRANTIES OR REPRESENTATIONS OF ANY KIND, EITHER EXPRESS OR IMPLIED.

### **NvmExpressDxe.uni**

Copyright (c) 2013 - 2014, Intel Corporation. All rights reserved.

This program and the accompanying materials are licensed and made available under the terms and conditions of the BSD License which accompanies this distribution. The full text of the license may be found at <http://opensource.org/licenses/bsd-license.php>.

THE PROGRAM IS DISTRIBUTED UNDER THE BSD LICENSE ON AN "AS IS" BASIS, WITHOUT WARRANTIES OR REPRESENTATIONS OF ANY KIND, EITHER EXPRESS OR IMPLIED.

### **NvmExpressDxeExtra.uni**

Copyright (c) 2014 - 2018, Intel Corporation. All rights reserved.

This program and the accompanying materials are licensed and made available under the terms and conditions of the BSD License which accompanies this distribution. The full text of the license may be found at <http://opensource.org/licenses/bsd-license.php>

THE PROGRAM IS DISTRIBUTED UNDER THE BSD LICENSE ON AN "AS IS" BASIS, WITHOUT WARRANTIES OR REPRESENTATIONS OF ANY KIND, EITHER EXPRESS OR IMPLIED.

### **NvmExpressHci.c**

Copyright (c) 2013 - 2018, Intel Corporation. All rights reserved.

This program and the accompanying materials are licensed and made available under the terms and conditions of the BSD License which accompanies this distribution. The full text of the license may be found at <http://opensource.org/licenses/bsd-license.php>.

THE PROGRAM IS DISTRIBUTED UNDER THE BSD LICENSE ON AN "AS IS" BASIS, WITHOUT WARRANTIES OR REPRESENTATIONS OF ANY KIND, EITHER EXPRESS OR IMPLIED.

### **NvmExpressHci.h**

(C) Copyright 2016 Hewlett Packard Enterprise Development LP

Copyright (c) 2013 - 2015, Intel Corporation. All rights reserved.

This program and the accompanying materials are licensed and made available under the terms and conditions of the BSD License which accompanies this distribution. The full text of the license may be found at <http://opensource.org/licenses/bsd-license.php>.

THE PROGRAM IS DISTRIBUTED UNDER THE BSD LICENSE ON AN "AS IS" BASIS, WITHOUT WARRANTIES OR REPRESENTATIONS OF ANY KIND, EITHER EXPRESS OR IMPLIED.

### **NvmExpressPassthru.c**

(C) Copyright 2014 Hewlett-Packard Development Company, L.P.

Copyright (c) 2013 - 2018, Intel Corporation. All rights reserved.

This program and the accompanying materials are licensed and made available under the terms and conditions of the BSD License which accompanies this distribution. The full text of the license may be found at <http://opensource.org/licenses/bsd-license.php>.















THE PROGRAM IS DISTRIBUTED UNDER THE BSD LICENSE ON AN "AS IS" BASIS, WITHOUT WARRANTIES OR REPRESENTATIONS OF ANY KIND, EITHER EXPRESS OR IMPLIED.









---

# Index

## Symbols

---

P (Programmed auto) .....	108, 184
S (Shutter-priority auto) .....	108, 185
A (Aperture-priority auto) .....	108, 186
M (Manual) .....	108, 188
S (Single frame) .....	109, 203
CL (Continuous low speed) .....	109, 203
CH (Continuous high speed) .....	109, 204
Q (Quiet shutter release) .....	110, 204
⌚ (Self-timer) .....	110, 204, 209
MUP (Mirror up) .....	110, 204, 211
 (Quick release-mode selection) .....	110, 205, 208
[+] (Single-point AF) .....	102, 153, 157
[*] (Dynamic-area AF) .....	102, 153, 157
 (3D-tracking) .....	102, 154, 157
[*] (Group-area AF) .....	103, 155, 158
 (Auto-area AF) .....	103, 156, 158
 (Face-priority AF) .....	105, 160
 (Wide-area AF) .....	105, 160
 (Normal-area AF) .....	105, 160
 (Subject-tracking AF) .....	105, 160
 (Matrix metering) .....	111, 178, 820
 (Center-weighted metering) .....	111, 178
 (Spot metering) .....	112, 179
 * (Highlight-weighted metering) .....	112, 179
 (Live view) button .....	55, 63
 button .....	88, 399
 button .....	94

 (Exposure compensation) button .....	117
 button .....	111
 (Help) button .....	125
 button .....	131
 (Help) .....	87
 menu .....	88
 (memory buffer) .....	207
 switch .....	874

## Numerics

---

1:1 (24×24) (Image area) .....	137, 141
1.2× (30×20) (Image area) .....	137, 141
16:9 (36×20) (Image area) .....	137, 141
3D-tracking .....	102, 154, 157
3D-tracking face-detection .....	811
5:4 (30×24) (Image area) .....	137, 141

## A

---

AC adapter .....	1060, 1069
Access-point mode .....	486, 488
Active D-Lighting .....	281
ADL bracketing (Auto bracketing set) .....	265
AE & flash bracketing (Auto bracketing set) .....	251
AE bracketing (Auto bracketing set) .....	251
AE-L icon .....	196
AF activation .....	810
AF fine-tuning options .....	894
AF-area mode .....	101, 153

AF-C.....	99, 149
AF-C priority selection .....	804
AF-F .....	100, 151
AF-mode button.....	98, 152, 163
AF-ON button.....	107, 173
AF-S.....	99, 100, 149, 151
AF-S priority selection.....	805
After burst, show.....	737
After delete.....	736
Airplane mode.....	929
Angle of view.....	1040
Aperture.....	186, 188, 194
Aperture lock.....	195
Aperture-priority auto .....	108, 186
Assign remote (WR) Fn button.....	928
Attaching a lens .....	35
Attenuator.....	793
Auto (Set Picture Control).....	125, 271
Auto (White balance).....	122, 221
Auto bracketing.....	113, 249, 778
Auto bracketing (mode M).....	841
Auto bracketing set.....	249
Auto distortion control.....	771
Auto DX crop.....	139
Auto ISO sensitivity control.....	116, 216
Auto  ISO sensitivity control.....	839
Auto send.....	506, 589
Auto-area AF.....	103, 156, 158
Auto-area AF face detection.....	812
Auto-area AF starting point.....	813
Autoexposure lock.....	196
Autofocus.....	148, 153, 173
Autofocus mode.....	98, 149
Autofocus mode restrictions.....	815

## B

---

Backup (Role played by card in Slot 2).....	308
Battery.....	28, 32, 47
Battery charger.....	28
Battery info.....	950
Beep options.....	923
BKT button.....	113, 252, 259, 265
Black-and-white (Monochrome).....	979
Bluetooth.....	77, 457, 469
Body cap.....	1061
Bracketing.....	251, 259, 265
Bracketing burst options.....	843
Bracketing order.....	842
Brightness.....	128
Built-in Wi-Fi.....	77, 457, 485
Bulb.....	191
Bulb (Long time-exposures).....	191
Burst photography.....	203

## C

---

Calibration.....	1114
Camera control.....	523, 546, 595
Camera Control Pro 2.....	595
Center-weighted area.....	820
Center-weighted metering.....	111, 178
CFexpress card.....	38, 1119
Choose color temperature (White balance).....	123, 223
Choose image area.....	137
Clarity.....	128
Clean image sensor.....	905, 1075
Clock battery.....	46, 1083
Cloudy (White balance).....	122, 222
Color space.....	765

Color temperature.....226, 231  
Compatible F mount lenses.... 1037  
Conformity marking..... 949  
Connect to PC (built-in Wi-Fi)...932  
Connect to smart device..470, 476,  
929  
Continuous AF.....99, 149  
Continuous high speed.....109, 204,  
824  
Continuous low speed.....109, 203,  
824  
Continuous shooting speed.....824  
Contrast.....128  
Copy image(s).....738  
Copyright information.....912  
CPU contacts.....1044  
CPU lens.....1037, 1044  
Creative Picture Control...126, 272  
Custom controls.....850, 879  
Custom groupings (C1/C2).....812  
Custom settings bank.....802  
Custom Settings menu.....797  
Customize command dials.....867  
Customize **i** menu..377, 844, 877  
Customize **i** menu (Lv).....846  
Cyanotype (Monochrome).....979

## D

---

Delete.....76, 429, 731  
Delete images from both slots 734  
Depth of field.....134, 186, 187  
Destination.....783  
Detaching lenses.....37  
Diffraction compensation 770, 789  
Diopter adjustment control.....14  
Direct connection to PC.....488  
Direct sunlight (White balance).....  
122, 222

Distortion control.....976  
D-Lighting.....973  
Dual-format recording PB slot 735  
DX (24×16) (Image area)..137, 141  
DX format.....137  
DX-based movie format.....293  
Dynamic-area AF.....102, 153, 157

## E

---

Easy Connect.....495  
Easy exposure compensation..819  
Edit movie.....300  
Effect level.....128  
Electronic front-curtain shutter.....  
827  
Electronic rangefinder.....176, 1049  
Electronic VR.....791  
EV steps for exposure cntrl.....818  
Exp./flash comp. step value.....818  
Exposure.....178, 196, 199, 249  
Exposure comp. for flash.....838  
Exposure compensation...117, 199  
Exposure data.....407  
Exposure delay mode.....827  
Exposure indicators.....190  
Exposure mode.....108, 182  
Exposure preview.....57, 60  
Exposure program.....1093  
Extended photo menu banks..754  
Extended shutter speeds (M)...828  
External microphone.....68, 1065  
Eyepiece shutter lever.....13

## F

---

Face-priority AF.....105, 160  
File information.....406  
File naming.....760, 783





<b>I</b>	
<hr/>	
Image area.....	136, 292
Image comment.....	911
Image Dust Off ref photo.....	906, 1010
Image overlay.....	980
Image quality.....	118, 142
Image review.....	394, 735
Image size.....	120, 145
Image transfer.....	523, 546
Incandescent (White balance).....	122, 222
Information display.....	893
Infrastructure mode.....	487, 494
Interval timer shooting.....	331
IPTC.....	914
<b>ISO</b> (ISO) button.....	114
ISO sensitivity.....	114, 213, 216
ISO sensitivity settings.....	764, 786
ISO sensitivity step value.....	818

## J

JPEG Slot 1 - JPEG Slot 2 (Role played by card in Slot 2).....	309
---	-----

## L

L (large).....	120, 145
Landscape (Set Picture Control).....	126, 272
Language.....	888
LCD illumination.....	833
LCD illuminator.....	8
Limit AF-area mode selection.....	814
Limit release mode selection.....	826
Limit selectable image area.....	829
Live view button options.....	874

Live view in continuous mode.....	835
Live view photography.....	55
Live view selector.....	55, 63
Lo (ISO sensitivity).....	215
Location data.....	7, 384
Location data (built-in).....	384, 925
Lock mirror up for cleaning.....	1078
Long exposure NR.....	767
Long time-exposures.....	191
Low sensitivity (Lo).....	215
Low-pass filter.....	1075

## M

M (manual focus).....	174
M (medium).....	120, 145
Manage Picture Control.....	276
Manual (Exposure mode).....	108, 188
Manual focus.....	174
Manual focus ring in AF mode.....	817
Matrix metering.....	111, 178, 820
Max. continuous release.....	825
Maximum aperture.....	379, 1039
Maximum sensitivity (Auto ISO sensitivity control).....	217
Maximum sensitivity with  .....	217
Memory card.....	38, 48, 1119
Memory card capacity.....	1120
<b>MENU</b> button.....	80
Metering.....	111, 178
Microphone.....	65, 1065
Microphone sensitivity.....	792
Mid-range sharpening.....	128
Minimum aperture.....	183
Minimum shutter speed (Auto ISO sensitivity control).....	218
Mired.....	230
Mirror up mode.....	110, 204, 211
<b>MODE</b> button.....	108

Modeling flash.....	134, 840
Monitor brightness.....	889
Monitor color balance.....	890
Monitor off delay.....	823
Monochrome.....	979
Monochrome (Set Picture Control).....	125, 272
Movie file type.....	785
Movie quality.....	294, 785
Movie shooting menu.....	782
Movies.....	63, 73
Multi selector.....	872
Multi selector center button.....	863, 884
Multiple exposure.....	318
My Menu.....	990

## N

---

Natural light auto (White balance).....	122, 222
NEF (RAW) processing.....	962
NEF (RAW) recording.....	762
Network settings.....	488, 494, 522, 544
Neutral (Set Picture Control).....	125, 271
Non-CPU lens.....	379, 1045, 1048
Non-CPU lens data.....	379, 904
Normal-area AF.....	105, 160

## O

---

On-camera flash photography.....	641
Optical VR.....	835
Overflow (Role played by card in Slot 2).....	308
Overview.....	416

## P

---

Peaking highlights.....	832
Peripheral connector.....	1107
Perspective control.....	978
Photo information.....	405
Photo shooting menu.....	750
Photo shooting menu bank.....	752
Picture Controls.....	125, 271
PIN-entry WPS.....	495
Pitch.....	892
Pixel mapping.....	910
Playback.....	71, 73, 390
Playback display options.....	733
Playback folder.....	732
Playback menu.....	730
Playback zoom.....	418
Portrait (Set Picture Control).....	126, 272
Power connector.....	1060, 1069
Predictive focus tracking.....	150
Preset manual (White balance).....	123, 224, 234
Press the shutter-release button all the way down.....	52
Programmed auto.....	108, 184
Protect.....	421
Push-button WPS.....	495
Pv button.....	134, 187

## Q

---

<b>QUAL</b> button.....	118
Quick crop.....	400, 420
Quick release-mode selection.....	110, 205, 208
Quick sharp.....	128
Quiet shutter release.....	110, 204

## R

---

Rating.....	423
RAW Slot 1 - JPEG Slot 2 (Role played by card in Slot 2).....	308
Rear control panel.....	833
Rear-curtain sync.....	132, 650
RECENT SETTINGS.....	990, 997
Rechargeable Li-ion battery.....	28
Red-eye correction.....	974
Red-eye reduction.....	131, 648
Release button to use dial.....	872
Release mode.....	109, 203
Release mode dial.....	109
Remote flash photography.....	663
Remote photography.....	459
Reset.....	312, 753, 803
Reset all settings.....	957
Reset movie shooting menu.....	783
Resize.....	968
Retouch menu.....	958
Reverse indicators.....	873
RGB histogram.....	408
Role played by card in Slot 2.....	308
Roll.....	892
Rotate tall.....	738

## S

---

S (small).....	120, 145
Saturation.....	128
Save/load menu settings.....	952
Search for Wi-Fi network.....	494
Security slot.....	7
Select to send.....	425, 504, 587
Self-timer.....	110, 204, 209, 823
Sepia (Monochrome).....	979
Setup menu.....	886
Shade (White balance).....	122, 222

Sharpening.....	128
Shooting data.....	410
Shutter spd & aperture lock.....	194, 867
Shutter speed.....	185, 188, 194
Shutter speed lock.....	194
Shutter-priority auto.....	108, 185
Shutter-release button.....	51, 170, 196
Shutter-release button AE-L.....	822
Silent live view photography.....	374
Single AF.....	99, 100, 149, 151
Single frame.....	109, 203
Single-point AF.....	102, 153, 157
Single-point AF watch area.....	811
Slide show.....	748
Slot empty release lock.....	951
Slow sync.....	131, 649
SnapBridge.....	77, 458
Spot metering.....	112, 179
Spot white balance.....	241
Standard (Set Picture Control).....	125, 271
Standby timer.....	53, 822
Stereo microphone (for movies).....	65
Storage folder.....	755
Store points by orientation.....	808
Straighten.....	975
Subject tracking AF.....	105, 160
Sub-selector.....	166, 171, 196
Sync. release mode options.....	826
Synchronize date and time.....	633
Synchronized release.....	628

## T

---

Thumbnail playback.....	391
Time (Long time-exposures).....	191

Time zone and date.....	43	Wireless LAN.....	77, 457, 521, 1063
Timecode.....	795	Wireless remote (WR) options.....	925
Time-lapse movie.....	348	Wireless remote controller.....	666, 925, 1063
Toning.....	128	Wireless Transmitter Utility.....	79, 485, 515
Touch controls.....	924	WR-R10.....	665, 925
Touch screen.....	18, 395	WT-6.....	78, 521, 1063
Trim.....	967		
Trim movie.....	989		
Two-button reset.....	312		
Type D lens.....	1044		
Type E lens.....	1044		
Type G lens.....	1044		

## U

---

USB.....	ii, 78
----------	--------

## V

---

Viewfinder photography.....	50
ViewNX-i.....	78, 445
Vignette control.....	769
Virtual horizon.....	95, 96, 862, 892
Vivid (Set Picture Control).....	125, 272
Voice memo.....	436
Voice memo options.....	920

## W

---

WB bracketing (Auto bracketing set).....	259
<b>WB</b> button.....	121
White balance.....	121, 221
Wide-area AF.....	105, 160
Wi-Fi.....	77, 461, 485, 521
Wi-Fi mode.....	461
Wind noise reduction.....	794
Wired LAN.....	78, 520
Wired LAN/WT.....	937

## X

---

XQD card.....	38, 1119
---------------	----------



No reproduction in any form of this manual, in whole or in part (except for brief quotation in critical articles or reviews), may be made without written authorization from NIKON CORPORATION.

**NIKON CORPORATION**

---

© 2020 Nikon Corporation



SB0102(11)  
6MB46511-02